

No. 24-1129

---

**IN THE UNITED STATES COURT OF APPEALS  
FOR THE DISTRICT OF COLUMBIA CIRCUIT**

---

STATE OF NEBRASKA, STATE OF ALABAMA, STATE OF ALASKA,  
STATE OF ARKANSAS, STATE OF FLORIDA, STATE OF GEORGIA,  
STATE OF IDAHO, STATE OF INDIANA, STATE OF IOWA, STATE OF  
KANSAS, COMMONWEALTH OF KENTUCKY, STATE OF LOUISIANA,  
STATE OF MISSISSIPPI, STATE OF MISSOURI, STATE OF MONTANA,  
STATE OF OKLAHOMA, STATE OF SOUTH CAROLINA, STATE OF  
SOUTH DAKOTA, STATE OF TENNESSEE, STATE OF TEXAS, STATE  
OF UTAH, COMMONWEALTH OF VIRGINIA, STATE OF WEST  
VIRGINIA, AND STATE OF WYOMING,

*Petitioners,*

*v.*

UNITED STATES ENVIRONMENTAL PROTECTION AGENCY  
AND MICHAEL S. REGAN, IN HIS OFFICIAL CAPACITY AS  
ADMINISTRATOR OF THE UNITED STATES  
ENVIRONMENTAL PROTECTION AGENCY,

*Respondents.*

---

**PETITION FOR REVIEW**

---

Under 42 U.S.C. § 7607(b)(1), Federal Rule of Appellate Procedure 15, and D.C. Circuit Rule 15(a), the States of Nebraska, Alabama, Alaska, Arkansas, Florida, Georgia, Idaho, Indiana, Iowa, Kansas, Kentucky, Louisiana, Mississippi, Missouri, Montana, Oklahoma, South Carolina, South Dakota, Tennessee, Texas, Utah, Virginia, West Virginia, and Wyoming petition this Court for review of the final agency action taken by Respondents United States Environmental Protection Agency and

Michael S. Regan, in his official capacity as Administrator of the United States Environmental Protection Agency, titled “Greenhouse Gas Emissions Standards for Heavy-Duty Vehicles—Phase 3,” published at 89 Fed. Reg. 29,440 (April 22, 2024). A copy of the agency action is attached to this petition.

Petitioners will show that the final rule exceeds the agency’s statutory authority and otherwise is arbitrary, capricious, an abuse of discretion, and not in accordance with law. Petitioners thus ask that this Court declare unlawful and vacate the agency’s final action.

Dated: May 13, 2024

Respectfully submitted.

MICHAEL T. HILGERS  
Attorney General of Nebraska

s/ Eric J. Hamilton

ERIC J. HAMILTON

*Solicitor General*

ZACHARY B. POHLMAN

*Assistant Solicitor General*

Nebraska Department of Justice

2115 State Capitol

Lincoln, Nebraska 68509

Tel.: (402) 471-2683

Fax: (402) 471-3297

eric.hamilton@nebraska.gov

zachary.pohlman@nebraska.gov

*Counsel for State of Nebraska*

STEVE MARSHALL  
Attorney General of Alabama

s/ Edmund G. LaCour Jr.

EDMUND G. LACOUR JR.  
*Solicitor General*  
Office of the Attorney General  
State of Alabama  
501 Washington Avenue  
P.O. Box 300152  
Montgomery, Alabama 36130-0152  
Tel.: (334) 242-7300  
Fax: (334) 353-8400  
edmund.lacour@alabamaag.gov

*Counsel for State of Alabama*

TIM GRIFFIN  
Attorney General of Arkansas

s/ Nicholas J. Bronni

NICHOLAS J. BRONNI  
*Solicitor General*  
DYLAN L. JACOBS  
*Deputy Solicitor General*  
Office of the Arkansas  
Attorney General  
323 Center Street, Suite 200  
Little Rock, Arkansas 72201  
Tel.: (501) 682-2007  
nicholas.bronni@arkansasag.gov  
dylan.jacobs@arkansasag.gov

*Counsel for State of Arkansas*

TREG R. TAYLOR  
Attorney General of Alaska

s/ Masha Kazakova

MASHA KAZAKOVA  
*Assistant Attorney General*  
Environmental Section  
Alaska Department of Law  
1031 West 4th Avenue, Suite 200  
Anchorage, Alaska 99501-1994  
Tel.: (907) 269-5211  
masha.kazakova@alaska.gov

*Counsel for State of Alaska*

ASHLEY MOODY  
Attorney General of Florida

s/ Henry C. Whitaker

HENRY C. WHITAKER  
*Solicitor General*  
JAMES H. PERCIVAL  
*Chief of Staff*  
Office of the Attorney General  
The Capitol, P1-01  
Tallahassee, Florida 32399-1050  
Tel.: (850) 414-3300  
Fax: (850) 410-2672  
henry.whitaker@myfloridalegal.com  
james.percival@myfloridalegal.com

*Counsel for State of Florida*

CHRISTOPHER M. CARR  
Attorney General of Georgia

s/ Stephen J. Petrany  
STEPHEN J. PETRANY  
*Solicitor General*  
Office of the Attorney General  
40 Capitol Square, SW  
Atlanta, Georgia 30334  
Tel.: (404) 458-3408  
spetrany@law.ga.gov

*Counsel for State of Georgia*

RAÚL R. LABRADOR  
Attorney General of Idaho

s/ Joshua N. Turner  
JOSHUA N. TURNER  
*Chief of Constitutional Litigation  
and Policy*  
ALAN M. HURST  
*Solicitor General*  
Office of the Idaho Attorney General  
P.O. Box 83720  
Boise, Idaho 83720  
Tel.: (208) 334-2400  
josh.turner@ag.idaho.gov  
alan.hurst@ag.idaho.gov

*Counsel for State of Idaho*

THEODORE E. ROKITA  
Attorney General of Indiana

s/ James A. Barta  
JAMES A. BARTA  
*Solicitor General*  
Indiana Attorney General's Office  
IGCS – 5th Floor  
302 W. Washington St.  
Indianapolis, Indiana 46204  
Tel.: (317) 232-0709  
james.barta@atg.in.gov

*Counsel for State of Indiana*

BRENNA BIRD  
Attorney General of Iowa

s/ Eric H. Wessan  
ERIC H. WESSAN  
*Solicitor General*  
1305 E. Walnut Street  
Des Moines, Iowa 50319  
Tel.: (515) 823-9117  
Fax: (515) 281-4209  
eric.wessan@ag.iowa.gov

*Counsel for State of Iowa*

KRIS W. KOBACH  
Attorney General of Kansas

s/ Anthony J. Powell

ANTHONY J. POWELL  
*Solicitor General*  
Office of the Kansas  
Attorney General  
120 SW 10th Avenue, 2nd Floor  
Topeka, Kansas 66612  
Tel.: (785) 368-8539  
Fax: (785) 296-3131  
anthony.powell@ag.ks.gov

*Counsel for State of Kansas*

ELIZABETH B. MURRILL  
Attorney General of Louisiana

s/ J. Benjamin. Aguiñaga

J. BENJAMIN AGUIÑAGA  
*Solicitor General*  
Louisiana Department of Justice  
1885 N. Third Street  
Baton Rouge, Louisiana 70802  
Tel.: (225) 506-3746  
aguinagab@ag.louisiana.gov

*Counsel for State of Louisiana*

RUSSELL COLEMAN  
Attorney General of Kentucky

s/ Matthew F. Kuhn

Matthew F. Kuhn  
*Solicitor General*  
Jacob M. Abrahamson  
*Assistant Solicitor General*  
Office of Kentucky Attorney General  
700 Capital Avenue, Suite 118  
Frankfort, Kentucky 40601  
Tel.: (502) 696-5300  
matt.kuhn@ky.gov  
jacob.abrahamson@ky.gov

*Counsel for Commonwealth  
of Kentucky*

LYNN FITCH  
Attorney General of Mississippi

s/ Justin L. Matheny

JUSTIN L. MATHENY  
*Deputy Solicitor General*  
Office of the Mississippi Attorney  
General  
P.O. Box 220  
Jackson, Mississippi 39205-0220  
Tel.: (601) 359-3825  
justin.matheny@ago.ms.gov

*Counsel for State of Mississippi*

ANDREW BAILEY  
Attorney General of Missouri

s/ Caleb Rutledge

CALEB RUTLEDGE  
*Assistant Attorney General*  
Attorney General's Office of  
Missouri  
Post Office Box 899  
Jefferson City, Missouri 65102  
Tel.: (573) 751-0812  
Fax: (573) 751-0774  
caleb.rutledge@ago.mo.gov

*Counsel for State of Missouri*

GENTNER DRUMMOND  
Attorney General of Oklahoma

s/ Garry M. Gaskins, II

GARRY M. GASKINS, II  
*Solicitor General*  
JENNIFER L. LEWIS  
*Deputy Attorney General*  
Office of the Attorney General  
of Oklahoma  
313 NE Twenty-First St.  
Oklahoma City, Oklahoma 73105  
Tel.: (405) 521-3921  
garry.gaskins@oag.ok.gov  
jennifer.lewis@oag.ok.gov

*Counsel for State of Oklahoma*

AUSTIN KNUDSEN  
Attorney General of Montana

s/ Christian B. Corrigan

CHRISTIAN B. CORRIGAN  
*Solicitor General*  
PETER M. TORSTENSEN, JR.  
*Deputy Solicitor General*  
Montana Department of Justice  
215 N. Sanders  
Helena, Montana 59601  
christian.corrigan@mt.gov  
peter.torstensen@mt.gov

*Counsel for State of Montana*

ALAN WILSON  
Attorney General of South Carolina

s/ Joseph D. Spate

JOSEPH D. SPATE  
*Assistant Deputy Solicitor General*  
1000 Assembly Street  
Columbia, South Carolina 29201  
Tel.: (803) 734-3371  
josephspate@scag.gov

*Counsel for State of South Carolina*

MARTY J. JACKLEY  
Attorney General of South Dakota

s/ Steve Blair

STEVE BLAIR

*Deputy Attorney General*

1302 East Highway 14, Suite 1

Pierre, South Dakota 57501-8501

Tel.: (605) 773-3215

atgservice@state.sd.us

*Counsel for State of South Dakota*

JONATHAN SKRMETTI  
Attorney General and Reporter  
of Tennessee

s/ J. Matthew Rice

J. MATTHEW RICE

*Solicitor General*

WHITNEY HERMANDORFER

*Director of Strategic Litigation*

Office of the Attorney General and  
Reporter of Tennessee

P.O. Box 20207

Nashville, Tennessee 37202-0207

Tel.: (615) 532-6026

matt.rice@ag.tn.gov

*Counsel for State of Tennessee*

KEN PAXTON  
Attorney General of Texas

SEAN REYES  
Attorney General of Utah

BRENT WEBSTER  
*First Assistant Attorney General*  
JAMES LLOYD  
*Deputy Attorney General for Civil  
Litigation*

s/ Stanford Purser  
STANFORD PURSER  
*Solicitor General*  
Office of the Utah Attorney General  
160 East 300 South, Fifth Floor  
Salt Lake City, Utah 84111  
Tel.: (385) 382-4334  
spurser@agutah.gov

KELLIE E. BILLINGS-RAY  
*Chief, Environmental Protection  
Division*

*Counsel for State of Utah*

s/ Wesley S. Williams

WESLEY S. WILLIAMS  
*Assistant Attorney General*  
Office of the Attorney General of  
Texas  
Environmental Protection Division  
P.O. Box 12548, MC-066  
Austin, Texas 78711-2548  
Tel.: (512) 463-2012  
Fax: (512) 320-0911  
wesley.williams@oag.texas.gov

*Counsel for State of Texas*



JASON MIYARES  
Attorney General of Virginia

s/ Kevin M. Gallagher  
KEVIN M. GALLAGHER  
*Principal Deputy Solicitor General*  
BRENDAN T. CHESTNUT  
*Deputy Solicitor General*  
Virginia Attorney General's Office  
202 North 9th Street  
Richmond, Virginia 23219  
Tel.: (804) 786-2071  
kgallagher@oag.state.va.us  
bchestnut@oag.state.va.us

*Counsel for Commonwealth of  
Virginia*

BRIDGET HILL  
Attorney General of Wyoming

s/ Ryan Schelhaas  
RYAN SCHELHAAS  
*Chief Deputy Attorney General*  
Office of the Wyoming Attorney  
General  
109 State Capitol  
Cheyenne, Wyoming 82002  
Tel.: (307) 777-5786  
ryan.schelhaas@wyo.gov

*Counsel for State of Wyoming*

PATRICK MORRISEY  
Attorney General of West Virginia

LINDSAY S. SEE  
*Solicitor General*  
s/ Michael R. Williams  
MICHAEL R. WILLIAMS  
*Principal Deputy Solicitor General*  
Office of the Attorney General of  
West Virginia  
State Capitol Complex  
Building 1, Room E-26  
Charleston, West Virginia 25301  
Tel.: (304) 558-2021  
lindsay.s.see@wvago.gov  
michael.r.williams@wvago.gov

*Counsel for State of West Virginia*

**CERTIFICATE OF SERVICE**

I certify that on May 13, 2024, I served a copy of this Petition for Review by United States first-class mail on the following:

The Honorable Michael S. Regan  
Administrator  
United States Environmental Protection Agency  
Mail Code 1101A  
1200 Pennsylvania Avenue NW  
Washington, D.C. 20460

Office of General Counsel  
United States Environmental Protection Agency  
Mail Code 2310A  
1200 Pennsylvania Avenue NW  
Washington, D.C. 20460

The Honorable Merrick B. Garland  
Attorney General of the United States  
U.S. Department of Justice  
950 Pennsylvania Avenue, NW  
Washington, D.C. 20530

Todd Kim  
Assistant Attorney General  
U.S. Department of Justice  
950 Pennsylvania Avenue, NW  
Washington, D.C. 20530

s/ Eric J. Hamilton  
ERIC J. HAMILTON

**ATTACHMENT**



**ENVIRONMENTAL PROTECTION AGENCY**

**40 CFR Parts 86, 1036, 1037, 1039, 1054, and 1065**

[EPA-HQ-OAR-2022-0985; FRL-8952-02-OAR]

RIN 2060-AV50

**Greenhouse Gas Emissions Standards for Heavy-Duty Vehicles—Phase 3**

**AGENCY:** Environmental Protection Agency (EPA).

**ACTION:** Final rule.

**SUMMARY:** The Environmental Protection Agency (EPA) is promulgating new greenhouse gas (GHG) emissions standards for model year (MY) 2032 and later heavy-duty highway vehicles that phase in starting as early MY 2027 for certain vehicle categories. The phase in revises certain MY 2027 GHG standards that were established previously under EPA’s Greenhouse Gas Emissions and Fuel Efficiency Standards for Medium- and Heavy-Duty Engines and Vehicles—Phase 2 rule (“HD GHG Phase 2”). This document also updates discrete elements of the Averaging Banking and Trading program, including providing additional flexibilities for manufacturers to support the implementation of the Phase 3 program balanced by limiting the availability of certain advanced technology credits initially established

under the HD GHG Phase 2 rule. EPA is also adding warranty requirements for batteries and other components of zero-emission vehicles and requiring customer-facing battery state-of-health monitors for plug-in hybrid and battery electric vehicles. In this action, we are also finalizing additional revisions, including clarifying and editorial amendments to certain highway heavy-duty vehicle provisions and certain test procedures for heavy-duty engines.

**DATES:** This final rule is effective on June 21, 2024. The incorporation by reference of certain material listed in this rule is approved by the Director of the Federal Register beginning June 21, 2024. The incorporation by reference of certain other material listed in this rule was previously approved by the Director of the Federal Register as of March 27, 2023.

**ADDRESSES:**

*Docket:* EPA has established a docket for this action under Docket ID No. EPA-HQ-OAR-2022-0985. Publicly available docket materials are available either electronically at [www.regulations.gov](http://www.regulations.gov) or in hard copy at Air and Radiation Docket and Information Center, EPA Docket Center, EPA/DC, EPA WJC West Building, 1301 Constitution Ave. NW, Room 3334, Washington, DC. For further information on EPA Docket Center

services and the current status, please visit us online at [www.epa.gov/dockets](http://www.epa.gov/dockets).

*Public Participation:* Docket: All documents in the docket are listed on the [www.regulations.gov](http://www.regulations.gov) website. Although listed in the index, some information is not publicly available, e.g., confidential business information (CBI) or other information whose disclosure is restricted by statute. Certain other material, such as copyrighted material, is not placed on the internet and will be publicly available only in hard copy form through the EPA Docket Center at the location listed in the **ADDRESSES** section of this document.

**FOR FURTHER INFORMATION CONTACT:**

Brian Nelson, Assessment and Standards Division, Office of Transportation and Air Quality, Environmental Protection Agency, 2000 Traverwood Drive, Ann Arbor, MI 48105; telephone number: (734) 214-4278; email address: [nelson.brian@epa.gov](mailto:nelson.brian@epa.gov).

**SUPPLEMENTARY INFORMATION:**

**Does this action apply to me?**

This action relates to companies that manufacture, sell, or import into the United States new heavy-duty highway vehicles and engines. This action also relates to state and local governments. Potentially affected categories and entities include the following:

Category	NAICS Codes <sup>a</sup>	NAICS Title
Industry	336110	Automobile and Light-duty Motor Vehicle Manufacturing
Industry	336120	Heavy Duty Truck Manufacturing
Industry	336211	Motor Vehicle Body Manufacturing
Industry	336213	Motor Home Manufacturing
Industry	333618	Other Engine Equipment Manufacturing
Industry	811198	All Other Automotive Repair and Maintenance

<sup>a</sup> NAICS Association. NAICS & SIC Identification Tools. Available online: <https://www.naics.com/search>

This table is not intended to be exhaustive, but rather provides a guide for readers regarding entities potentially affected by this action. This table lists the types of entities that EPA is now aware could potentially be affected by this action. Other types of entities not listed in the table could also be affected. To determine whether your entity is regulated by this action, you should carefully examine the applicability criteria found in 40 CFR parts 86, 1036, 1037, 1039, 1054, and 1065.<sup>1</sup> If you have questions regarding the applicability of

this action to a particular entity, consult the person listed in the **FOR FURTHER INFORMATION CONTACT** section.

**What action is the agency taking?**

The Environmental Protection Agency (EPA) is promulgating new GHG standards for model year (MY) 2032 and later heavy-duty highway vehicles that phase in starting as early MY 2027 for certain vehicle categories. The phase in revises certain MY 2027 GHG standards that were established previously under EPA’s Greenhouse Gas Emissions and Fuel Efficiency Standards for Medium- and Heavy-Duty Engines and Vehicles—Phase 2 rule. We believe these “Phase

3” standards are appropriate and feasible considering lead time, costs, and other factors. EPA also finds that it is appropriate (1) to limit the availability of certain advanced technology credits initially established under the HD GHG Phase 2 rule, and (2) to include additional flexibilities for manufacturers in applying credits from these incentives in the early model years of this Phase 3 program. EPA is also adding warranty requirements for batteries and other components of zero-emission vehicles and requiring customer-facing battery state-of-health monitors for plug-in hybrid and battery electric vehicles. We are also finalizing

<sup>1</sup> See 40 CFR 1036.1 through 1036.15 and 1037.1 through 1037.15.

revisions and clarifying and editorial amendments to certain highway heavy-duty vehicle provisions of 40 CFR part 1037 and certain test procedures for heavy-duty engines in 40 CFR parts 1036 and 1065. We also note that EPA included in this action's notice of proposed rulemaking (hereafter referred to as the "HD GHG Phase 3 NPRM") a proposal to revise its regulations addressing preemption of state regulation of new locomotives and new engines used in locomotives; those revisions were finalized in a separate action on November 8, 2023.<sup>2,3</sup>

**What is the agency's authority for taking this action?**

Clean Air Act (CAA) section 202(a), 42 U.S.C. 7521(a), requires that EPA establish emission standards for air pollutants from new motor vehicles or new motor vehicle engines, which, in the Administrator's judgment, cause or contribute to air pollution that may reasonably be anticipated to endanger public health or welfare. The Administrator has found that GHG emissions from highway heavy-duty vehicles and engines cause or contribute to air pollution that may endanger public health or welfare. Therefore, the Administrator is exercising his authority under CAA section 202(a)(1)-(2) to establish standards for GHG emissions from highway heavy-duty vehicles. See section I.D of this preamble for more information on the agency's authority for this action.

**Did EPA conduct a peer review before issuing this action?**

This regulatory action is supported by influential scientific information. EPA, therefore, conducted peer review in accordance with the Office of Management and Budget's (OMB) Final Information Quality Bulletin for Peer Review. First, we conducted a peer review of the underlying data and algorithms in MOVES4 that served as the basis for MOVES4.R3 used to estimate the emissions impacts of the final standards. In addition, we conducted a peer review of the Heavy-Duty Technology Resource Use Case Scenario (HD TRUCS) tool used to analyze HD vehicle energy usage and associated component costs. We also conducted a peer review of a Heavy-Duty Vehicle Industry Characterization, Technology Assessment, and Costing Report developed by FEV Consulting.

All peer review was in the form of letter reviews conducted by a contractor. The peer review reports for each analysis are in the docket for this action and at EPA's Science Inventory (<https://cfpub.epa.gov/si/>).

**Table of Contents**

- Executive Summary
  - A. Purpose of This Regulatory Action
  - B. The Opportunity for New Standards Based on Advancements in Heavy-Duty Vehicle Technologies Which Prevent or Control GHG Emissions
  - C. Overview of the Final Regulatory Action
  - D. Impacts of the Standards
  - E. Coordination With Federal and State Partners
  - F. Stakeholder Engagement
- I. Statutory Authority for the Final Rule
  - A. Summary of Key Clean Air Act Provisions
  - B. Authority To Consider Technologies in Setting Motor Vehicle GHG Standards
  - C. Response to Other Comments Raising Legal Issues
- II. Final HD Phase 3 GHG Emission Standards
  - A. Public Health and Welfare Need for GHG Emission Reductions
  - B. Summary of Comments and the HD GHG Phase 3 Standards and Updates From Proposal
  - C. Background on the CO2 Emission Standards in the HD GHG Phase 2 Program
  - D. Vehicle Technologies and Supporting Infrastructure
  - E. Technology, Charging Infrastructure, and Operating Costs
  - F. Final Standards
  - G. EPA's Basis for Concluding That the Final Standards Are Feasible and Appropriate Under the Clean Air Act
  - H. Alternatives Considered
  - I. Small Businesses
- III. Compliance Provisions, Flexibilities, and Test Procedures
  - A. Revisions to the ABT Program
  - B. Battery Durability Monitoring and Warranty Requirements
  - C. Additional Revisions to the Regulations
- IV. Program Costs
  - A. IRA Tax Credits
  - B. Technology Package Costs
  - C. Manufacturer Costs
  - D. Purchaser Costs
  - E. Social Costs
- V. Estimated Emission Impacts From the Final Standards
  - A. Model Inputs
  - B. Estimated Emission Impacts From the Final Standards
- VI. Climate, Health, Air Quality, Environmental Justice, and Economic Impacts
  - A. Climate Change Impacts
  - B. Health and Environmental Effects Associated With Exposure to Non-GHG Pollutants
  - C. Air Quality Impacts of Non-GHG Pollutants
  - D. Environmental Justice
  - E. Economic Impacts
  - F. Oil Imports and Electricity and Hydrogen Consumption

- VII. Benefits of the Program
  - A. Climate Benefits
  - B. Non-GHG Health Benefits
  - C. Energy Security
- VIII. Comparison of Benefits and Costs
  - A. Methods
  - B. Results
- IX. Analysis of Alternative CO2 Emission Standards
  - A. Comparison of Final Standards and Alternative
  - B. Emission Inventory Comparison of Final Rule and Slower Phase-In Alternative
  - C. Program Costs Comparison of the Final Rule and Alternative
  - D. Benefits
  - E. How do the final standards and alternative compare in overall benefits and costs?
- X. Statutory and Executive Order Reviews
  - A. Executive Order 12866: Regulatory Planning and Review and Executive Order 14094: Modernizing Regulatory Review
  - B. Paperwork Reduction Act (PRA)
  - C. Regulatory Flexibility Act (RFA)
  - D. Unfunded Mandates Reform Act (UMRA)
  - E. Executive Order 13132: Federalism
  - F. Executive Order 13175: Consultation and Coordination With Indian Tribal Governments
  - G. Executive Order 13045: Protection of Children From Environmental Health and Safety Risks
  - H. Executive Order 13211: Actions Concerning Regulations That Significantly Affect Energy Supply, Distribution, or Use
  - I. National Technology Transfer and Advancement Act (NTTAA) and 1 CFR Part 51
  - J. Executive Order 12898: Federal Actions To Address Environmental Justice in Minority Populations and Low-Income Populations and Executive Order 14096: Revitalizing Our Nation's Commitment to Environmental Justice for All
  - K. Congressional Review Act (CRA)
  - L. Judicial Review
  - M. Severability
- XI. Statutory Authority and Legal Provisions

**Executive Summary**

*A. Purpose of This Regulatory Action*

The Environmental Protection Agency (EPA) is finalizing this action to further reduce greenhouse gas (GHG) air pollution from highway heavy-duty (hereafter referred to as "heavy-duty" or HD) engines and vehicles across the United States. This final rule establishes new CO2 emission standards for MY 2032 and later HD vehicles with more stringent CO2 standards phasing in as early as MY 2027 for certain vehicle categories. We have assessed and demonstrated that these standards are appropriate and feasible considering cost, lead time, and other relevant factors, as described throughout this preamble and supporting materials in the docket for this final rule. Under the

<sup>2</sup> Notice of Proposed Rulemaking for Greenhouse Gas Emissions Standards for Heavy-Duty Vehicles—Phase 3. 88 FR 25926, April 27, 2023.

<sup>3</sup> Final Rulemaking for Locomotives and Locomotive Engines; Preemption of State and Local Regulations. 88 FR 77004, November 8, 2023.

Clean Air Act (CAA) “the Administrator shall by regulation prescribe (and from time to time revise) . . . standards applicable to the emission of any air pollutant from any class or classes of new motor vehicles or new motor vehicle engines, . . . which in his judgment cause, or contribute to, air pollution which may reasonably be anticipated to endanger public health or welfare.” The regulation “shall take effect after such period as the Administrator finds necessary to permit the development and application of the requisite technology, giving appropriate consideration to the cost of compliance within such period.” Despite the significant emissions reductions achieved by previous rulemakings, GHG emissions from HD vehicles continue to adversely impact public health and welfare, and there is a critical need for further GHG reductions. The transportation sector is the largest U.S. source of GHG emissions, representing 29 percent of total GHG emissions,<sup>4</sup> and within this, heavy-duty vehicles are the second largest contributor to GHG emissions and are responsible for 25 percent of GHG emissions in the sector.<sup>5</sup> At the same time, there have been significant advances in technologies to prevent and control GHG emissions from heavy-duty vehicles, and we project there will be more such advances. These final regulations appropriately take advantage of those projected available and cost-reasonable motor vehicle technologies to set more stringent GHG standards that will significantly reduce GHG emissions from heavy-duty vehicles. In general, the final standards are less stringent than proposed for the early model years of the program and more stringent or equivalent to the proposed standards in later model years (expect for heavy-heavy vocational vehicles which are less stringent in later model years; see section ES.C.2.ii of this preamble for more details).

GHG emissions have significant adverse impacts on public health and welfare. In 2009, the Administrator issued an Endangerment Finding under CAA section 202(a), concluding that GHG emissions from new motor vehicles and engines, including heavy-duty vehicles and engines, cause or contribute to air pollution that may endanger public health or welfare.<sup>6</sup> After making such a finding, EPA is

mandated to issue GHG standards “to regulate emissions of the deleterious pollutant from new motor vehicles.” *State of Massachusetts v. EPA*, 549 U.S. 497, 533 (2007). Therefore, following the 2009 Endangerment Finding, EPA promulgated GHG regulations for heavy-duty vehicles and engines in 2011 and 2016.<sup>7</sup> We refer to the EPA-specific GHG regulations found within the “Greenhouse Gas Emissions and Fuel Efficiency Standards for Medium- and Heavy-Duty Engines and Vehicles—Phase 1” and “Greenhouse Gas Emissions and Fuel Efficiency Standards for Medium- and Heavy-Duty Engines and Vehicles—Phase 2” final rulemakings as “HD GHG Phase 1” and “HD GHG Phase 2” respectively throughout this preamble (*i.e.*, we are not including any reference to the Department of Transportation (DOT) fuel efficiency standards in those rulemakings in using these terms in this preamble). In the HD GHG Phase 1 and Phase 2 programs, EPA set GHG emission standards that the Agency found appropriate and feasible at that time, considering cost, lead time, and other relevant factors, in 2011 and 2016, respectively.<sup>8</sup> Meanwhile, major scientific assessments continue to be released that further advance our understanding of the climate system and the impacts that GHGs have on public health and welfare both for current and future generations, as discussed in detail in section II.A.

At the same time, manufacturers have continued to find ways to further reduce and eliminate tailpipe emissions from new motor vehicles, resulting in a range of technologies with the potential for further significant reductions of GHG emissions from HD motor vehicles. These include but are not limited to reductions reflecting increased use of advanced internal combustion vehicle and engine technologies and including increased use of hybrid technologies. These also include technologies with the greatest potential HD vehicle GHG emission reductions, such as battery electric vehicle technologies (BEV) and fuel cell electric vehicle technologies (FCEV). These technologies—which are already being adopted by the HD industry—present an opportunity for significant reductions in heavy-duty

GHG emissions over the long term. While standards promulgated pursuant to CAA section 202(a)(1)–(2) are based on application of technology, the statute does not specify a particular technology or technologies that must be used to set such standards; rather, Congress has authorized and directed EPA to adapt its standards to “the development and application of the requisite technology” as determined by the Administrator.<sup>9</sup>

Major trucking fleets, HD vehicle and engine manufacturers, and U.S. states have announced plans to increase the use of these technologies in the coming years. Tens of billions of dollars are being invested not only in these technologies, but also to increase the infrastructure necessary for their successful deployment, including electric charging and hydrogen refueling infrastructure, manufacturing and production of batteries, and domestic sources of critical minerals and other important elements of the supply chain. The 2021 Infrastructure Investment and Jobs Act (commonly referred to as the “Bipartisan Infrastructure Law” or BIL) and the Inflation Reduction Act of 2022 (“Inflation Reduction Act” or IRA) accelerate these ongoing trends by together including many incentives for the development, production, and sale of a wide range of advanced technologies (including BEVs, plug-in hybrid electric vehicles (PHEVs), FCEVs, and others), electric charging infrastructure, and hydrogen, which are expected to spur significant innovation in the heavy-duty sector.<sup>10</sup> Technical assessments and data provided by commenters during the public comment period for this action’s notice of proposed rulemaking (hereafter referred to as the “HD GHG Phase 3 NPRM”) as well as comments on related rules, which proposed strengthening existing MY 2027 GHG standards for heavy-duty vehicles, support that significant adoption of technologies with the greatest potential to reduce GHG emissions and associated infrastructure growth is expected to occur over the next decade.<sup>11 12 13 14</sup> We summarize

<sup>9</sup> CAA section 202(a)(2).

<sup>10</sup> Infrastructure Investment and Jobs Act, Public Law 117–58, 135 Stat. 429 (2021) (“Bipartisan Infrastructure Law” or “BIL”), available at <https://www.congress.gov/117/plaws/publ58/PLAW-117publ58.pdf>; Inflation Reduction Act of 2022, Public Law 117–169, 136 Stat. 1818 (2022) (“Inflation Reduction Act” or “IRA”), available at <https://www.congress.gov/117/bills/hr5376/BILLS-117hr5376enr.pdf>.

<sup>11</sup> Notice of Proposed Rulemaking for Control of Air Pollution from New Motor Vehicles: Heavy-Duty Engine and Vehicle Standards. 87 FR 17414 (March 28, 2022).

<sup>12</sup> U.S. EPA, “Control of Air Pollution from New Motor Vehicles: Heavy-Duty Engine and Vehicle

<sup>4</sup> EPA (2023). Inventory of U.S. Greenhouse Gas Emissions and Sinks: 1990–2021 (EPA–430–R–23–002, published April 2023).

<sup>5</sup> EPA (2023). Inventory of U.S. Greenhouse Gas Emissions and Sinks: 1990–2021 (EPA–430–R–23–002, published April 2023).

<sup>6</sup> 74 FR 66496, December 15, 2009.

<sup>7</sup> 76 FR 57106, September 15, 2011; 81 FR 73478, October 25, 2016.

<sup>8</sup> See, *e.g.*, 40 CFR 1036.101(a)(2) (engines, overview of emission standards); 40 CFR 1036.108 (engine GHG standards, exhaust emissions of CO<sub>2</sub>, CH<sub>4</sub>, and N<sub>2</sub>O); 40 CFR 1037.101(a)(2) (vehicles, overview of emission standards); 40 CFR 1037.105 and 1037.106 (vehicle GHG standards, exhaust emissions of CO<sub>2</sub> for vocational vehicles and tractors).

these developments in section B of this Executive Summary, and provide further detail in section I of the HD GHG Phase 3 NPRM, section II of this final rule, and Regulatory Impact Analysis (RIA) Chapters 1 and 2.<sup>15 16</sup>

In addition, technologies for vehicles with ICE, along with a range of electrification, exist today and continue to evolve to further reduce and eliminate exhaust emissions from new motor vehicles. For example, some of these technologies include improvements to the efficiency of the engine, transmission, drivetrain, aerodynamics, and tire rolling resistance in HD vehicles that reduce their GHG emissions. Another example of a technology under development by manufacturers that reduces vehicle GHG emissions is HD vehicles that use hydrogen-fueled internal combustion engines (H<sub>2</sub>-ICE), which have zero engine-out CO<sub>2</sub> emissions. The heavy-duty industry has also been developing hybrid powertrains, which consist of an ICE as well as an electric drivetrain and some designs also incorporate plug-in capability. Hybrid powered vehicles may provide CO<sub>2</sub> emission reductions through the use of downsized engines, recovering energy through regenerative braking system that is normally lost while braking, and providing additional engine-off operation during idling and coasting. Hybrid powertrains are available today in a number of heavy-duty vocational vehicles including passenger van/shuttle bus, transit bus, street sweeper, refuse hauler, and delivery truck applications—and as noted in the preceding paragraph, plug-in hybrid technologies are included in advanced technology incentives under IRA. We discuss these technology developments further in section II of this final rule, and Regulatory Impact Analysis (RIA) Chapters 1 and 2.

With respect to the need for GHG reductions and after consideration of these and other heavy-duty sector developments, EPA is finalizing in this action new CO<sub>2</sub> emission standards for MY 2032 and later HD vehicles with

more stringent CO<sub>2</sub> standards phasing in as early as MY 2027 for certain vehicle categories (*i.e.*, more stringent than what was finalized in HD GHG Phase 2). We have assessed and demonstrated that these standards are appropriate and feasible considering cost, lead time, and other relevant factors, as described throughout this preamble and supporting materials in the docket for this final rule. EPA considers safety, consistent with CAA section 202(a)(4), and may consider other factors such as the impacts of potential GHG standards on the industry, fuel savings, oil conservation, energy security, and other relevant considerations. These standards build on decades of EPA regulation of harmful pollution from HD vehicles. Pursuant to our section 202(a) authority, EPA first established standards for the heavy-duty sector in the 1970s. Since then, the Agency has revised the standards multiple times based upon updated data and information, the continued need to mitigate air pollution, and congressional enactments directing EPA to regulate emissions from the heavy-duty sector more stringently. Since 1985, HD engine and vehicle manufacturers have been able to comply with standards using averaging;<sup>17</sup> EPA also introduced banking and trading compliance flexibilities in the HD program in 1990;<sup>18</sup> and EPA explained that manufacturers could use the Averaging, Banking and Trading (ABT) flexibilities to meet more stringent standards at lower cost. EPA's HD GHG standards and regulations have consistently included an ABT program from the start,<sup>19</sup> and have relied on averaging as the basis for standards of greater stringency.<sup>20</sup> Since the first CAA section 202(a) HD standards in 1972, subsequent standards have extended to additional pollutants (*e.g.*, particulate matter and GHGs), have increased in stringency, and have spurred the development and deployment of

numerous new vehicle and engine technologies to reduce pollution. For example, the Phase 2 GHG standards for HD vehicles (81 FR 73478, October 25, 2016) were projected to reduce CO<sub>2</sub> emissions by approximately 1.1 billion metric tons over the lifetime of the new vehicles sold under the program (see, *e.g.*, 81 FR 73482), and the most recent “criteria-pollutant”<sup>21</sup> standards are projected to reduce oxides of nitrogen (NO<sub>x</sub>) emissions from the in-use HD fleet by almost 50 percent by 2045 (“Control of Air Pollution from New Motor Vehicles: Heavy-Duty Engine and Vehicle Standards” (hereafter referred to as “HD2027 Low NO<sub>x</sub> final rule,” 88 FR 4296, January 24, 2023)). This final rule builds upon EPA's multi-decadal tradition of regulating heavy-duty vehicles and engines, by applying the Agency's clear and longstanding statutory authority to consider the feasibility and costs of reducing harmful pollution using new real-world data and information, including the effects of recent congressional action in the BIL and IRA.

We are issuing this HD vehicle GHG Phase 3 Final Rulemaking (“HD GHG Phase 3 final rule”) which finalizes certain revised HD vehicle carbon dioxide (CO<sub>2</sub>) standards for MY 2027 and certain new HD vehicle CO<sub>2</sub> standards for MYs 2028, 2029, 2030, 2031, and 2032 that will achieve significant GHG reductions for these and later model years. (Note that the MY 2032 standards will remain in place for MY 2033 and thereafter unless and until new standards are promulgated.) The final standards we are promulgating take into account the ongoing technological innovation in the HD vehicle space and reflect CO<sub>2</sub> emission standards that we have assessed and demonstrated are appropriate and feasible considering cost, lead time, and other relevant factors, as described throughout this preamble and supporting materials in the docket for this final rule.<sup>22</sup>

In this rulemaking, EPA did not reopen (1) the other HD GHG standards, including nitrous oxide (N<sub>2</sub>O), methane

Standards—Response to Comments.” Section 28. Docket EPA–HQ–OAR–2019–0055.

<sup>13</sup> Notice of Proposed Rulemaking for Greenhouse Gas Emissions Standards for Heavy-Duty Vehicles—Phase 3. 88 FR 25926, April 27, 2023.

<sup>14</sup> U.S. EPA. Response to Comments (RTC)—Greenhouse Gas Emissions Standards for Heavy-Duty Vehicles: Phase 3. EPA–420–R–24–007. March 2024.

<sup>15</sup> Notice of Proposed Rulemaking for Greenhouse Gas Emissions Standards for Heavy-Duty Vehicles—Phase 3. 88 FR 25926, April 27, 2023.

<sup>16</sup> U.S. EPA. Regulatory Impact Analysis—Greenhouse Gas Emissions Standards for Heavy-Duty Vehicles: Phase 3. EPA–420–R–24–006. March 2024.

<sup>17</sup> 50 FR 10606, March 15, 1985; see also *NRDC v. Thomas*, 805 F.2d 410, 425 (D.C. Cir. 1986) (upholding emissions averaging in the 1985 HD final rule).

<sup>18</sup> 55 FR 30584, July 26, 1990.

<sup>19</sup> 76 FR 57128, September 15, 2011 (explaining ABT is a flexibility that provides an opportunity for manufacturers to make necessary technological improvements while reducing the overall cost of the program); 81 FR 73495, October 25, 2016 (explaining that ABT plays an important role in providing manufacturers flexibilities, including helping reduce costs).

<sup>20</sup> For example, in promulgating the HD GHG Phase 2 standards, we explained that the stringency of the HD GHG Phase 2 standards were derived on a fleet average technology mix basis and that the emission averaging provisions of ABT meant that the regulations did not require all vehicles to meet the standards. See, *e.g.*, 81 FR 73715.

<sup>21</sup> We refer to PM, oxides of nitrogen (NO<sub>x</sub>), Volatile Organic Compounds (VOCs), hydrocarbons (HC), carbon monoxide (CO), sulfur dioxide (SO<sub>2</sub>), more generally as “criteria pollutants” throughout this preamble.

<sup>22</sup> We note that EPA also included in the HD GHG Phase 3 NPRM a proposal to revise its regulations addressing preemption of state regulation of new locomotives and new engines used in locomotives; those revisions were finalized in a separate action on November 8, 2023, and therefore are not discussed further in this final rule. Final Rulemaking for Locomotives and Locomotive Engines; Preemption of State and Local Regulations. 88 FR 77004, November 8, 2023.

(CH<sub>4</sub>), and CO<sub>2</sub> emission standards that apply to heavy-duty engines and the hydrofluorocarbon (HFC) emission standards that apply to heavy-duty vehicles, (2) any portion of our heavy-duty compliance provisions, flexibilities, and testing procedures, including those in 40 CFR parts 1037, 1036, and 1065, other than those specifically identified in our proposal (e.g., EPA did not reopen the general availability of Averaging, Banking, and Trading), and (3) the existing approach taken in both HD GHG Phase 1 and Phase 2 that compliance with vehicle emission standards is based on emissions from the vehicle, including that compliance with vehicle exhaust CO<sub>2</sub> emission standards is based on CO<sub>2</sub> emissions from the vehicle. We further note that we did not reopen anything on which we did not propose or solicit comment.

*B. The Opportunity for New Standards Based on Advancements in Heavy-Duty Vehicle Technologies Which Prevent or Control GHG Emissions*

1. Brief Overview of the Heavy-Duty Industry

Heavy-duty highway vehicles range from commercial pickup trucks; to vocational vehicles that support local and regional transportation, construction, refuse collection, and delivery work; to line-haul tractors (semi-trucks) that move freight cross-country. This diverse array of vehicles is categorized into weight classes based on gross vehicle weight ratings (GVWR). These weight classes span Class 2b pickup trucks and vans from 8,500 to 10,000 pounds GVWR through Class 8 line-haul tractors and other commercial vehicles that exceed 33,000 pounds GVWR. While Class 2b and 3 complete pickups and vans are not included in this rulemaking, Class 2b and 3 vocational vehicles are included in this rulemaking (as discussed further in section II.C).<sup>23</sup>

Heavy-duty highway vehicles are powered through an array of different means. Currently, the HD vehicle fleet is primarily powered by diesel-fueled, compression-ignition (CI) engines. However, gasoline-fueled, spark-ignition

(SI) engines are common in the lighter weight classes, and smaller numbers of alternative fuel engines (e.g., liquified petroleum gas, compressed natural gas) are found in the heavy-duty fleet. We refer to the vehicles powered by internal combustion engines as ICE vehicles (or ICEV) throughout this preamble. An increasing number of HD vehicles are powered by technologies that do not have any tailpipe emissions such as battery electric vehicle (BEV) technologies and hydrogen fuel cell electric vehicles (FCEVs). These technologies have seen significant growth in recent years, for example, EPA certified approximately 400 HD BEVs in MY 2020, 1,200 HD BEVs in MY 2021, and 3,400 HD BEVs in MY 2022 across several vehicle categories. We use the term zero-emission vehicle (ZEV) technologies throughout the preamble to refer to technologies that result in zero tailpipe emissions, and vehicles that use these ZEV technologies we refer to collectively as ZEVs in this preamble.<sup>24</sup> Hybrid vehicles (including plug-in hybrid electric vehicles) include energy storage features such as batteries and also include an ICE.<sup>25</sup> Further background on the HD industry can be found in section II.D, RIA Chapter 1, and HD GHG Phase 3 NPRM section I.A.<sup>26</sup>

The industry that designs and manufactures HD vehicles is composed of three primary segments: vehicle manufacturers, engine manufacturers and other major component manufacturers, and secondary manufacturers (i.e., body builders). Some vehicle manufacturers are vertically integrated (designing,

developing, and testing their engines in-house for use in their vehicles). Others purchase some or all of their engines from independent engine suppliers. At the time of this rulemaking, only one major independent engine manufacturer supports the HD industry, though some vehicle manufacturers sell their engines or “incomplete vehicles” (i.e., a chassis that includes the engine, the frame, and a transmission) to body builders who design and assemble the final vehicle. Each of these subindustries is often supported by common suppliers for subsystems such as transmissions, axles, engine controls, and emission controls.

In addition to the manufacturers and suppliers responsible for producing HD vehicles, an extended network of dealerships, repair and service facilities, and rebuilding facilities contributes to the sale, maintenance, and extended life of these vehicles and engines. HD vehicle dealerships offer customers a place to order such vehicles from a specific manufacturer and often include service facilities for those vehicles and their engines. Dealership service technicians are generally trained to perform regular maintenance and make repairs, which generally include repairs under warranty and in response to manufacturer recalls. Some trucking fleets, businesses, and large municipalities hire their own technicians to service their vehicles in their own facilities. Many refueling centers along major trucking routes have also expanded their facilities to include roadside assistance and service stations to diagnose and repair common problems.

The end-users for HD vehicles are as diverse as the applications for which these vehicles are purchased. Smaller weight class HD vehicles are commonly purchased by delivery services, contractors, and municipalities. The middle weight class vehicles tend to be used as commercial vehicles for business purposes and municipal work that transport people and goods locally and regionally or provide services such as utilities. Vehicles in the heaviest weight classes are generally purchased by businesses with high load demands, such as construction, towing or refuse collection, or freight delivery fleets and owner-operators for regional and long-haul goods movement. The competitive nature of the businesses and owner-operators that purchase and operate HD vehicles means that any time at which the vehicle is unable to operate due to maintenance or repair (i.e., downtime) can lead to a loss in income. The customers’ need for reliability drives much of the vehicle manufacturers’ innovation and research efforts.

<sup>23</sup> Class 2b and 3 vehicles with GVWR between 8,500 and 14,000 pounds are primarily commercial pickup trucks and vans and are sometimes referred to as “medium-duty vehicles”. The vast majority of Class 2b and 3 vehicles are chassis-certified vehicles, and we included those vehicles in the proposed combined light-duty and medium-duty rulemaking action, consistent with E.O. 14037, section 2a. Heavy-duty engines and vehicles are also used in nonroad applications, such as construction equipment; nonroad heavy-duty engines, equipment, and vehicles are not within the scope of this FRM.

<sup>24</sup> Throughout the preamble, we use the term ZEV technologies to refer to technologies that result in zero tailpipe emissions. Example ZEV technologies include battery electric vehicles and fuel cell vehicles.

<sup>25</sup> Furthermore, hydrogen-powered internal combustion engines (H<sub>2</sub>-ICE) fueled with neat hydrogen emit zero engine-out CO<sub>2</sub> emissions (as well as zero engine-out HC, CH<sub>4</sub>, CO emissions). We recognize that there may be negligible, but non-zero, CO<sub>2</sub> emissions at the tailpipe of H<sub>2</sub>-ICE that use selective catalytic reduction (SCR) aftertreatment systems and are fueled with neat hydrogen due to contributions from the aftertreatment system from urea decomposition. As further explained in preamble section III, H<sub>2</sub>-ICE are considered to emit near zero CO<sub>2</sub> emissions under our part 1036 regulations and are deemed zero under our part 1037 regulations, consistent with our treatment of CO<sub>2</sub> emissions that are attributable to the aftertreatment systems in compression-ignition ICEs. H<sub>2</sub>-ICE also emit certain criteria pollutants. H<sub>2</sub>-ICE are not included in what we refer to collectively as ZEVs throughout this final rule. Note, NO<sub>x</sub> and PM emission testing is required under existing 40 CFR part 1036 for engines fueled with neat hydrogen.

<sup>26</sup> Notice of Proposed Rulemaking for Greenhouse Gas Emissions Standards for Heavy-Duty Vehicles—Phase 3. 88 FR 25926, April 27, 2023.



2. History of Greenhouse Gas Emission Standards for Heavy-Duty Engines and Vehicles

EPA has a longstanding practice of regulating GHG emissions from the HD sector. In 2009, EPA and the U.S. Department of Transportation’s (DOT’s) National Highway Traffic Safety Administration (NHTSA) began working on a coordinated regulatory program to reduce GHG emissions and fuel consumption from HD vehicles and engines.<sup>27</sup> The first phase of the HD GHG and fuel efficiency program was finalized in 2011 (76 FR 57106, September 15, 2011) (“HD GHG Phase 1”).<sup>28</sup> The HD GHG Phase 1 program set performance-based standards and largely adopted approaches consistent with recommendations from the National Academy of Sciences. The HD GHG Phase 1 program, which began in MY 2014 and was phased in through MY 2018, included separate standards for HD vehicles and HD engines. The program offered flexibility allowing manufacturers to attain these standards through any mix of technologies and the option to participate in an ABT program.

In 2016, EPA and NHTSA finalized the HD GHG Phase 2 program.<sup>29</sup> The HD GHG Phase 2 program included more stringent, performance-based emission standards for HD vehicles and HD engines that phase in over the long term, with initial standards for most vehicles and engines commencing in MY 2021, increasing in stringency in MY 2024, and culminating in even more stringent MY 2027 standards. HD GHG Phase 2 built upon the Phase 1 program and set standards based not only on then-currently available technologies, but also on technologies that were either still under development or not yet widely deployed at the time of the HD GHG Phase 2 final rule. To ensure adequate time for technology development, HD GHG Phase 2 provided up to 10 years lead time to allow for the development and phase-in of these control technologies. EPA recently finalized technical amendments to the HD GHG Phase 2

rulemaking (“HD Technical Amendments”) that included changes to the test procedures for heavy-duty engines and vehicles to improve accuracy and reduce testing burden.<sup>30</sup>

As with the previous HD GHG Phase 1 and Phase 2 rules and light-duty GHG rules, EPA has coordinated with the DOT and NHTSA during the development of this final rule. This included coordination prior to and during the interagency review conducted under E.O. 12866. EPA has also consulted with the California Air Resources Board (CARB) during the development of this final rule, as EPA also did during the development of the HD GHG Phase 1 and 2 and light-duty rules. See section ES.E of this preamble for additional detail on EPA’s coordination with DOT/NHTSA, additional Federal agencies, and CARB.

3. What has changed since EPA finalized the HD GHG Phase 2 rule?

i. Technology Advancements

When EPA promulgated the HD GHG Phase 2 rule in 2016, the agency established the CO<sub>2</sub> standards on the premise of GHG-reducing technologies for vehicles with ICE including technologies such as hybrid powertrains. However, in 2016 we projected that ZEV technologies, such as BEVs and FCEVs, would become more widely available in the heavy-duty market over time, but would not be available and cost-competitive in significant volume in the timeframe of the Phase 2 program. EPA finalized BEV, PHEV, and FCEV advanced technology credit multipliers to encourage the development and availability of these advanced technologies at a faster pace because of their potential for large GHG emissions reductions.

Several significant developments have occurred since 2016 that point to ZEV technologies becoming more readily available much sooner than EPA had previously projected for the HD sector. These developments are summarized here, but more detail can be found in the section II and HD GHG NPRM section ES.B or I.C).<sup>31</sup> These developments support the feasibility of ZEV technologies and render adoption of ZEV technologies to reduce GHG emissions more cost-competitive than ever before. First, the HD market has evolved such that early ZEV models are in use today for some applications and are expected to expand to many more;

costs of ZEV technologies have gone down and are projected to continue to fall; and manufacturers have announced and begun to implement plans to rapidly increase their investments in ZEV technologies over the next decade. While some HD vehicle manufacturers and firms that purchase HD fleets cautioned in comments that such announcements may change, several HD vehicle manufacturers also commented that their MYs 2024–2027 production plans include ZEVs for their planned compliance with the previously promulgated Phase 2 standards.<sup>32</sup> In 2022 and 2023, there were several manufacturers producing fully electric HD vehicles for use in a variety of applications, and these volumes are expected to rise (see RIA Chapter 1.5). The cost to manufacture lithium-ion batteries (the single most expensive component of a BEV) has dropped significantly in the past eight years, and that cost is projected to continue to fall during this decade, all while the performance of the batteries (in terms of energy density) improves.<sup>33 34</sup> Many of the manufacturers that produce HD vehicles and major firms that purchase HD vehicles have announced billions of dollars’ worth of investments in ZEV technologies and significant plans to transition to a zero-carbon fleet over the next ten to fifteen years.<sup>35 36 37</sup> See section II.D of this preamble, RIA Chapter 1, and HD GHG NPRM section I.C.1 for further information.<sup>38</sup> Furthermore, we also have seen development of technologies such as H<sub>2</sub>–ICE that also will significantly reduce CO<sub>2</sub> emissions from HD vehicles.

Second, in enacting the 2021 BIL and the 2022 IRA laws, Congress chose to provide significant and unprecedented

<sup>32</sup> See RTC section 10.3.1.

<sup>33</sup> Mulholland, Eamonn. “Cost of electric commercial vans and pickup trucks in the United States through 2040.” Page 7. January 2022. Available at <https://theicct.org/wp-content/uploads/2022/01/cost-ev-vans-pickups-us-2040-jan22.pdf>.

<sup>34</sup> Sharpe, Ben and Hussein Basma. “A meta-study of purchase costs for zero-emission trucks”. The International Council on Clean Transportation, Working Paper 2022–09 (February 2022). Available online: <https://theicct.org/publication/purchase-cost-ze-trucks-feb22>.

<sup>35</sup> Environmental Defense Fund (2022) September 2022 Electric Vehicle Market Update: Manufacturer Commitments and Public Policy Initiatives Supporting Electric Mobility in the U.S. and Worldwide, available online at: [https://blogs.edf.org/climate411/files/2022/09/ERM-EDF-Electric-Vehicle-Market-Report\\_September2022.pdf](https://blogs.edf.org/climate411/files/2022/09/ERM-EDF-Electric-Vehicle-Market-Report_September2022.pdf).

<sup>36</sup> EDF Comments to the HD GHG Phase 3 NPRM. EPA–HQ–OAR–2022–0985–1644–A1.

<sup>37</sup> Heavy Duty Trucking Staff, ‘Autocar, GM to Produce Fuel-Cell Electric Vocational Trucks,’ Trucking Info (December 11, 2023). <https://www.truckinginfo.com/10211875/autocar-and-gm-announce-electric-truck-joint-venture>.

<sup>38</sup> 88 FR 25926, April 27, 2023.

<sup>27</sup> Greenhouse gas emissions from heavy-duty vehicles are primarily carbon dioxide (CO<sub>2</sub>), but also include methane (CH<sub>4</sub>), nitrous oxide (N<sub>2</sub>O), and hydrofluorocarbons (HFC).

<sup>28</sup> National Research Council; Transportation Research Board. The National Academies’ Committee to Assess Fuel Economy Technologies for Medium- and Heavy-Duty Vehicles; “Technologies and Approaches to Reducing the Fuel Consumption of Medium- and Heavy-Duty Vehicles.” 2010. Available online: <https://www.nap.edu/catalog/12845/technologies-and-approaches-to-reducing-the-fuel-consumption-of-medium-and-heavy-duty-vehicles>.

<sup>29</sup> 81 FR 73478, October 25, 2016.

<sup>30</sup> 86 FR 34308, June 29, 2021.

<sup>31</sup> Notice of Proposed Rulemaking for Greenhouse Gas Emissions Standards for Heavy-Duty Vehicles—Phase 3. 88 FR 25926, April 27, 2023.

monetary incentives for the production and purchase of qualified ZEVs in the HD market, as well as certain key components. These laws also provide incentives for qualifying electric charging infrastructure and for clean hydrogen production and refueling infrastructure, which will further support a rapid increase in market penetration of HD ZEVs. As a few examples, BIL provisions include \$5 billion to fund the replacement of school buses with clean and zero- or low-emission buses (EPA’s “Clean School Bus Program”) and over \$5.5 billion to support the purchase of zero- or low-emission transit buses and associated infrastructure, with up to \$7.5 billion to help build out a national network of EV charging and hydrogen refueling infrastructure through DOT’s Federal Highway Administration (FHWA), some of which can be used for refueling of heavy-duty vehicles.<sup>39</sup> The IRA creates a tax credit available from calendar year (CY) 2023 through CY 2032 of up to \$40,000 per vehicle for vehicles over 14,000 pounds (and up to \$7,500 per vehicle for vehicles under 14,000 pounds) for the purchase of qualified commercial clean vehicles; provides tax credits available from CY 2023 through CY 2032 (phasing down starting in CY 2030) for the production and sale of battery cells and modules of up to \$45 per kilowatt-hour (kWh); and also provides tax credits for 10 percent of the cost of producing applicable critical minerals (including those found in batteries and fuel cells, provided that the minerals meet certain specifications), when such components or minerals are produced in the United States. The IRA also modifies an existing tax credit that applies to alternative fuel refueling property (e.g., electric vehicle chargers and hydrogen fueling stations) and extends the tax credit through CY 2032; starting in CY 2023, this provision provides a tax credit of up to 30 percent of the cost of the qualified alternative fuel refueling property (e.g., HD BEV charging and hydrogen refueling equipment) and up to \$100,000 per item when located in low-income or non-urban area census tracts and certain other requirements are met. Further, the IRA includes the

<sup>39</sup> While jurisdictions are not required to build stations specifically for heavy-duty vehicles, FHWA’s guidance encourages states to consider station designs and power levels that could support heavy-duty vehicles. U.S. Department of Transportation, Federal Highway Administration, “National Electric Vehicle Infrastructure Formula Program: Bipartisan Infrastructure Law—Program Guidance (Update)”. June 2, 2023. Available online: [https://www.fhwa.dot.gov/environment/nevi/formula\\_prog\\_guid/90d\\_nevi\\_formula\\_program\\_guidance.pdf](https://www.fhwa.dot.gov/environment/nevi/formula_prog_guid/90d_nevi_formula_program_guidance.pdf).

“Clean Heavy-Duty Vehicles” program, which includes \$400 million to make awards to eligible recipients/contractors that propose to replace eligible vehicles to serve one or more communities located in an air quality area designated pursuant to CAA section 107 as nonattainment for any air pollutant, in fiscal year (FY) 2022 and available through FY 2031. The IRA also includes the “Grants to Reduce Air Pollution at Ports” program, which appropriates \$3 billion (\$750 million of which is for projects located in areas of nonattainment for any air pollutant) in FY 2022 and available through FY 2027, to reduce air pollution at ports. These are only a few examples of a wide array of incentives in both laws that will help to reduce the costs to manufacture, purchase, and operate ZEVs, thereby bolstering their adoption in the market. See section II.E.4 of this preamble, RIA Chapter 1, and HD GHG NPRM section I.C.2 for further information.<sup>40</sup>

Third, there have been multiple actions by states to accelerate the adoption of HD ZEV technologies. As of February 15, 2023, the State of California and ten other states have adopted the Advanced Clean Trucks (ACT) program that includes a manufacturer requirement for zero-emission truck sales, and CAA section 177 empowers additional states to adopt California’s ACT program if they wish.<sup>41 42 43</sup> The ACT program requires

<sup>40</sup> 88 FR 25926, April 27, 2023.

<sup>41</sup> California Air Resources Board, Final Regulation Order—Advanced Clean Trucks Regulation. Filed March 15, 2021. Available at: <https://ww2.arb.ca.gov/sites/default/files/barcu/regact/2019/act2019/fro2.pdf>.

<sup>42</sup> Oregon, Washington, New York, New Jersey, and Massachusetts adopted ACT beginning in MY 2025 while Vermont and New Mexico adopted ACT beginning in MY 2026, and Colorado, Maryland, and Rhode Island in MY 2027.

<sup>43</sup> California Air Resources Board, States that have Adopted California’s Vehicle Regulations. Available at: <https://ww2.arb.ca.gov/our-work/programs/advanced-clean-cars-program/states-have-adopted-californias-vehicle-regulations>; See also, e.g., Final Advanced Clean Truck Amendments, 1461 Mass. Reg. 29 (January 21, 2022) (Massachusetts); Medium- and Heavy-Duty (MHD) Zero Emission Truck Annual Sales Requirements and Large Entity Reporting, 44 N.Y. Reg. 8 (January 19, 2022) (New York), available at <https://dos.ny.gov/system/files/documents/2022/01/011922.pdf>; Advanced Clean Trucks Program and Fleet Reporting Requirements, 53 N.J.R. 2148(a) (December 20, 2021) (New Jersey), available at [https://www.nj.gov/dep/rules/adoptions/adopt\\_20211220a.pdf](https://www.nj.gov/dep/rules/adoptions/adopt_20211220a.pdf) (pre-publication version); Clean Trucks Rule 2021, DEQ-17-2021 (November 17, 2021), available at <http://records.sos.state.or.us/ORSOSWebDrawer/Recordhtml/8581405> (Oregon); Low emission vehicles, Wash. Admin. Code 173-423-070 (2021), available at <https://app.leg.wa.gov/wac/default.aspx?cite=173-423-070>; 2021 Wash. Reg. 587356 (December 15, 2021); Wash. Reg. 21-24-059 (November 29, 2021) (amending Wash. Admin. Code 173-423 and 173-400), available at <https://lawfilesexet.leg.wa.gov/law/wsrpdf/2021/24/21-24>

that “manufacturers who certify Class 2b–8 chassis or complete vehicles with combustion engines would be required to sell zero-emission or near-zero emission such as plug-in hybrid trucks as an increasing percentage of their annual [state] sales from 2024 to 2035.”<sup>44 45</sup> In addition, 17 states plus the District of Columbia and Quebec (in Canada) have signed a Memorandum of Understanding establishing goals to support widespread electrification of the HD vehicle market.<sup>46</sup> See RIA Chapter 1 and HD GHG NPRM section I.C.3 for further information.<sup>47</sup> While independent of EPA’s section 202 standards, these efforts nonetheless indicate the interest at the state level for increasing electrification of the HD vehicle market.

ii. Development of a HD GHG Phase 3 Program

Recognizing the need for additional GHG reductions from HD vehicles and the growth of advanced HD vehicle technologies, including ZEV technologies, EPA believes this increased application of technologies in the HD sector that prevent and control GHG emissions from HD vehicles presents an opportunity to strengthen GHG standards, which can result in significant reductions in heavy-duty vehicle emissions. Based on an in-depth analysis of the potential for the development and application of such technologies in the HD sector, in April 2023 we proposed in the HD GHG Phase 3 NPRM GHG standards for MYs 2027 through 2032 and later HD vehicles more stringent than the Phase 2 GHG standards.<sup>48</sup> The proposed Phase 3

*059.pdf* (Washington); “More electric, hydrogen, and hybrid passenger and commercial vehicles coming to New Mexico starting in 2026” <https://www.env.nm.gov/wp-content/uploads/2023/11/2023-11-16-COMMS-More-electric-hydrogen-and-hybrid-passenger-and-commercial-vehicles-coming-to-New-Mexico-starting-in-2026-Final.pdf>.

<sup>44</sup> California Air Resources Board, Advanced Clean Trucks Fact Sheet (August 20, 2021), available at <https://ww2.arb.ca.gov/resources/fact-sheets/advanced-clean-trucks-fact-sheet>. See also California Air Resources Board, Final Regulation Order—Advanced Clean Trucks Regulation. Filed March 15, 2021. Available at: <https://ww2.arb.ca.gov/sites/default/files/barcu/regact/2019/act2019/fro2.pdf>.

<sup>45</sup> EPA granted the ACT rule waiver requested by California under CAA section 209(b) on March 30, 2023. 88 FR 20688, April 6, 2023 (signed by the Administrator on March 30, 2023).

<sup>46</sup> Multi-State MOU (July 2022), available at <https://www.nescaum.org/documents/multi-state-medium-and-heavy-duty-zev-action-plan.pdf>. States include California, Colorado, Connecticut, Hawaii, Maine, Maryland, Massachusetts, Nevada, New Jersey, New York, North Carolina, Oregon, Pennsylvania, Rhode Island, Vermont, Virginia, and Washington.

<sup>47</sup> 88 FR 25926, April 27, 2003.

<sup>48</sup> 88 FR 25926, April 27, 2003.

standards included (1) revised GHG standards for many MY 2027 HD vehicles, with a subset of standards that we did not propose to change, and (2) new GHG standards starting in MYs 2028 through 2032, of which the MY 2032 standards would remain in place for MYs 2033 and later. In the HD GHG Phase 3 NPRM, EPA requested comment on setting more stringent GHG standards beyond the MYs proposed for MYs 2033 through 2035. EPA also requested comment on an alternative set of GHG standards for MYs 2027 through 2032 that were less stringent than those proposed yet still more stringent than the Phase 2 standards. We also requested comment, including supporting data and analysis, as to whether there are certain market segments, such as heavy-haul vocational trucks or long-haul tractors which may require significant energy content for their intended use, for which it may be appropriate to set standards less stringent than the alternative for the specific corresponding regulatory subcategories in order to provide additional lead time to develop and introduce ZEV or other low emission HD vehicle technologies for those specific vehicle applications. In consideration of the environmental impacts of HD vehicles and the need for significant emission reductions, we also requested comment on a more stringent set of GHG standards starting in MYs 2027 through 2032 whose values would go beyond the proposed standards, such as values that would be comparable to the stringency levels in California's ACT program, values in between these proposed standards and those that would be comparable to stringency levels in ACT, and values beyond those that would be comparable to stringency levels in ACT, such as stringency levels comparable to the 50–60 percent ZEV adoption range represented by the publicly stated goals of several major original equipment manufacturers (OEMs) for 2030.<sup>49 50 51 52 53</sup> Finally, after

considering the state of the HD market, new incentives, and comments received on the HD2027 NPRM regarding Advanced Technology Credit Multipliers (“credit multipliers”) under the HD GHG Phase 2 program, EPA proposed to end credit multipliers for BEVs and PHEVs one year earlier than provided in the existing HD GHG Phase 2 program (*i.e.*, no credit multipliers for BEVs and PHEVs in MYs 2027 and later).

The final standards and requirements we are promulgating in this action are based on further consideration of the data and analyses included in the proposed rule, additional supporting data and analyses we conducted in support of this final rule, and consideration of the extensive public input EPA received in response to the proposed rule. These considerations and analyses are described in detail throughout this preamble, the RIA, and the Response to Comments document (RTC) accompanying this preamble, found in the docket to this rule (EPA–HQ–OAR\_2022–0985). In the remainder of this section, we summarize the final program and key changes from the proposal in the section immediately following, followed by a summary of the impacts of the standards, EPA's statutory authority, and coordination with partners and stakeholders.

### C. Overview of the Final Regulatory Action

EPA carefully considered input from stakeholders, as discussed throughout this preamble and in our accompanying RTC. This preamble section contains an overview of stakeholders' key concerns, an overview of how EPA has adjusted approaches in the final rule after further consideration, and an overview of the final standards. More detailed discussion of the final rule and key comments and EPA's consideration of them is included in the rest of the preamble, and the RTC contains detailed comment excerpts, comment summaries and EPA's responses.

#### 1. Overview of Stakeholder Positions on Standards' Stringency

EPA's HD GHG Phase 3 Proposed Rule was signed by Administrator Michael Regan on April 11, 2023, and published in the **Federal Register** on April 27, 2023 (88 FR 25926). EPA held two days of public hearings on May 2 and 3, 2023, and the public comment period ended on June 16, 2023. EPA received over 172,000 comments in the

public docket, of which over 230 had detailed comments. In addition, 185 people testified over the two-day public hearing period and EPA held dozens of follow-up meetings with a broad range of stakeholders including environmental justice (EJ) stakeholders, labor unions, manufacturers, fleets, truck dealerships, power sector-related organizations, environmental and public health non-governmental organizations (NGOs), and states. Memoranda regarding these meetings are in the rulemaking docket.

We note that very generally, in comments on the NPRM stakeholders demonstrated strong and opposing views on major issues, including: stringency of the standards, the rate of increasing stringency of the standards year over year from early model years to later model years, availability and readiness of future ZEV infrastructure, availability of minerals critical to battery production and assurance of supply chain readiness for those materials, impact of the IRA tax credits, and key elements of EPA's analysis such as technical feasibility, costs of ZEV technologies, and other elements. For example, many commenters representing environmental NGOs, public health NGOs, environmental justice organizations, front-line communities and some state and local governments supported standards that would be more stringent than our proposed standards in terms of both stringency level and year-over-year pacing of increased stringency, with many supporting standards comparable with stringency levels used in California's ACT program, and some supporting even higher levels (*e.g.*, 100 percent ZEVs by 2035). A number of these commenters provided EPA with technical analyses and data to support their view that infrastructure necessary to support ZEVs is projected to be ready within the rule time frame, and that there would be sufficient critical minerals as well, such that standards more stringent than those EPA proposed are feasible. Generally, many of these commenters included various technical submissions on how EPA purportedly underestimated ZEV feasibility and adoption, underestimated the impacts of the BIL and IRA in contributing to the further development of the ZEV market, and overestimated ZEV-related costs—which, they argue when accounted for, would have led EPA to consider standards that are more stringent than those proposed. Citing the public health and environmental needs for pollutant reductions that can be achieved with ZEV technology, especially in places such as fence-line and overburdened

<sup>49</sup> California Air Resources Board, Final Regulation Order—Advanced Clean Trucks Regulation. Filed March 15, 2021. Available at: <https://www2.arb.ca.gov/sites/default/files/barcu/regact/2019/act2019/fro2.pdf>.

<sup>50</sup> Scania, ‘Scania's Electrification Roadmap,’ Scania Group, November 24, 2021, <https://www.scania.com/group/en/home/newsroom/news/2021/Scania-electrification-roadmap.html>.

<sup>51</sup> AB Volvo, ‘Volvo Trucks Launches Electric Truck with Longer Range,’ Volvo Group, January 14, 2022, <https://www.volvogroup.com/en/news-and-media/news/2022/jan/news-4158927.html>.

<sup>52</sup> Deborah Lockridge, ‘What Does Daimler Truck Spin-off Mean for North America?,’ Trucking Info (November 11, 2021), <https://www.truckinginfo.com/10155922/what-does-daimler-truck-spin-off-mean-for-north-america>.

<sup>53</sup> Navistar presentation at the Advanced Clean Transportation (ACT) Expo, Long Beach, CA (May 9–11, 2022).

communities, many of these commenters also suggested more stringent or faster pacing of standards for specific subcategories of vehicles such as tractors, school/transit buses, etc. These commenters generally supported EPA's proposed elimination of credit multipliers for BEVs and PHEVs one year earlier than provided in the existing HD GHG Phase 2 program and some asked EPA to finalize even further limitations of the credit multipliers. EPA requested comment on what, if any, additional information and data EPA should consider collecting and monitoring during the implementation of the Phase 3 standards, including with respect to the important issues of refueling and charging infrastructure for ZEVs; on this topic, this general set of commenters expressed strong opposition to any action EPA would take to create a regulatory self-adjusting link between such monitoring and amending standards to decrease their stringency.

In stark contrast, commenters representing many truck manufacturers, owners, fleets, and dealers, along with some labor groups and some states, voiced support for standards less stringent than even the lowest levels of stringency on which we requested comment in the proposal, *i.e.*, considerably less stringent than the alternative presented in the HD GHG Phase 3 NPRM. A few commenters representing certain truck manufacturers supported the proposed MY 2032 standards but were concerned about the stringency of the early model year standards. Many commenters representing truck manufacturers, owners, fleets, and dealers opposed any revision to the model year 2027 standards and, even at lower overall stringency levels, voiced support for a much more gradual pace of increasing stringency of the standards—with some suggesting standards not commencing until model years 2030 and 2033. Part of their argument is that Phase 2 established GHG vehicle and engine standards for MY 2027 which are challenging, and manufacturers have made compliance plans to meet those standards. In their view, amending those MY 2027 standards cuts against these plans. These commenters also state that, although manufacturers intend to introduce ZEVs in larger numbers over time (and have invested billions of dollars already to do so),<sup>54</sup> there is too much uncertainty regarding availability of supporting electrification

(or hydrogen) infrastructure, critical minerals, and supply chains to increase the stringency of the MY 2027 standards. Some of these commenters further asserted that the CAA mandates four years of lead time and three years of standard stability for revisions of heavy-duty vehicle and engine emissions standards for any pollutant, including GHGs, citing CAA section 202(a)(3)(B) and (C). A number of these commenters provided EPA with technical analyses and data to support their view that ZEV infrastructure would fall far short of what would be needed to support ZEV adoption levels presented in the potential compliance pathway on which the proposed standards were predicated, and that critical minerals would remain a limitation to ZEV growth in the HD sector. Generally, many of these commenters included various technical submissions on how EPA purportedly overestimated ZEV adoption, overestimated the impacts of the BIL and IRA in contributing to the further development of the ZEV market, and underestimated ZEV-related costs. Citing the concerns that unexpectedly slow infrastructure development could impact manufacturers' ability to comply with Phase 3, a number of these commenters called for EPA to conduct extensive monitoring of post-rule infrastructure buildout and further suggested that EPA establish mechanisms for the standards to self-adjust to become less stringent if the infrastructure deployment was found to be insufficient. These commenters generally opposed EPA's proposed elimination of credit multipliers for BEVs and PHEVs one year earlier than provided in the existing HD GHG Phase 2 program and some asked for an extension of certain technology credit multipliers beyond MY 2027. The commenters representing certain truck manufacturers who supported the proposed MY 2032 standards but expressed concern with early model year standards more specifically cited the early MY standards as being too stringent and progressing in stringency at too steep of an increase given uncertainties associated with sufficiency of supportive electrical infrastructure in the program's initial years.

Commenters from the petroleum industry and others challenged EPA's authority to issue the proposed standards at all.<sup>55</sup> Terming the proposal a "ZEV mandate," they asserted that the

question of whether EPA has authority to issue standards reflecting performance of different vehicle powertrains under the CAA implicates the Major Questions Doctrine, and assert that CAA section 202(a) does not contain the correspondingly requisite clear statement authorizing EPA to do so. These commenters also assert that EPA predicated the proposed standards on averaging under the ABT program, such that vehicles with zero tailpipe emissions purportedly must be averaged with emitting vehicles for manufacturers to be able to meet the standards, is beyond EPA's authority. These commenters stated they were asserting this lack of authority both because, in their view, such averaging implicates the Major Questions Doctrine and EPA lacks a clear statement of authorization from Congress to do so, and because, in their view, averaging and the ABT program are inconsistent with CAA statutory provisions for certification, warranty, and civil penalties, all of which they state contemplate individualized determinations, not determinations on average.

EPA heard from some representatives from the heavy-duty vehicle manufacturing industry both optimism regarding the heavy-duty industry's ability to produce ZEV applications in future years at high volume, but also concern that a slow deployment of electrification infrastructure (magnitude of potential upgrades to the electrical distribution system necessary to support depot charging, and public charging infrastructure) could slow the growth of heavy-duty ZEV adoption, and that this may present challenges for vehicle manufacturers' ability to comply with EPA HD GHG Phase 3 standards. Concerns about uncertainties relating to supporting infrastructure included: limited nature of today's HD charging infrastructure, the magnitude of buildout of electrical distribution systems necessary to support (BEVs especially in the early model years of the program), the cost and length of time needed for infrastructure buildout, a chicken-egg dynamic whereby prospective BEV purchasers will not act until assured of adequate supporting infrastructure, and utilities will not build out the infrastructure without assurance of demand, and the lack of availability of hydrogen infrastructure. Some commenters further noted that fleets and owners will be reluctant to buy, or may cancel orders for, ZEVs, if/when ZEV infrastructure is a barrier. Commenters raised these concerns on top of those voiced by some

<sup>54</sup> See, for example, comments from the Truck and Engine Manufacturers (EMA), EPA-HQ-OAR-2022-0985-2668-A1.

<sup>55</sup> See, for example, comments from American Free Enterprise Chamber of Commerce, EPA-HQ-OAR-2022-0985-1660.

manufacturers that more lead time is needed for product development, especially given uncertainty regarding purchasers' decisions, noting customer reluctance to utilize an unfamiliar technology, and asserted barriers associated with limited range and cargo penalty due to need for large batteries. These comments are discussed in more detail in section II and in Chapters 6, 7, and 8 of the RTC.

2. Overview of Consideration of Key Concerns From Stakeholders and the Final Standards

i. Improvements to EPA's Technical and Infrastructure Analyses

EPA considered the wide-ranging perspectives, data and analyses submitted in support of stakeholder positions, as well as new studies and data that became available after the proposal. As a consequence, EPA believes that the technical analyses supporting the final rule are improved and more robust. For example, in our technology analysis tool (HD TRUCS, see section II of this preamble) we have adjusted our battery and other component cost assumptions, revised vehicle efficiency values, refined the battery sizing determination, added public charging, increased depot charging costs and diesel prices, added Federal excise tax (FET) and state tax, increased charging equipment installation costs, included more charger sharing, and increased hydrogen fuel costs. Based on consideration of feedback from commenters, in HD TRUCS we also adjusted the technology payback schedule using a publicly-available model. After consideration of comment (and as EPA signaled at proposal), we also have adjusted our analytical baseline by increasing the amount of ZEV adoption in our "no-action" scenario (*i.e.*, without this rule) to reflect ZEV adoption required by California's ACT program, as well as further ZEV adoption in other states. These and many more updates described throughout this preamble and the RIA strengthen the analyses supporting the final standards.

We also improved our analysis of infrastructure readiness and cost by including projected needed upgrades to the electricity distribution system under our potential compliance pathway in our analysis. As described in section II of this preamble, our improved analysis of charging infrastructure needs and costs supports the feasibility of the future growth of ZEV technology of the magnitude EPA is projecting in this final rule's potential compliance pathway's technology packages. EPA

further notes that we recognize that charging and refueling infrastructure for BEVs and FCEVs is necessary for success in the increasing development and adoption of those vehicle technologies (further discussed in section II and RIA Chapters 1 and 2). There are significant efforts already underway to develop and expand heavy-duty vehicle electric charging and hydrogen refueling infrastructure. The U.S. government is making large investments through the BIL and the IRA, as discussed in more detail in RIA Chapter 1.3 (*e.g.*, this includes a tax credit for charging or hydrogen refueling infrastructure as well as billions of additional dollars for programs that could help fund charging infrastructure if purchased alongside an electric vehicle).<sup>56 57</sup> Private investments will also play a critical role in meeting future infrastructure needs, as discussed in more detail in RIA Chapter 1.6. We expect many BEV or fleet owners to invest in depot-based charging infrastructure (see RIA Chapter 2.6 for information on our analysis of charging needs and costs). Manufacturers, charging network providers, energy companies and others are also investing in high-power public or other stations that will support public charging. For example, Daimler Truck North America is partnering with electric power generation company NextEra Energy Resources and BlackRock Renewable Power to collectively invest \$650 million to create a nationwide U.S. charging network for commercial vehicles with a later phase of the project also supporting hydrogen fueling stations.<sup>58</sup> Volvo Group and Pilot announced their intent to offer public charging for medium- and heavy-duty BEVs at priority locations throughout the network of 750 Pilot and Flying J North American truck stops and travel plazas.<sup>59</sup> A recent assessment by Atlas Public Policy estimated that \$30 billion in public and private investments had been committed as of the end of 2023

<sup>56</sup> Inflation Reduction Act, Public Law 117–169 (2022).

<sup>57</sup> Bipartisan Infrastructure Law, Public Law 117–58, 135 Stat. 429 (2021).

<sup>58</sup> NextEra Energy. News Release: "Daimler Truck North America, NextEra Energy Resources and BlackRock Renewable Power Announce Plans to Accelerate Public Charging Infrastructure for Commercial Vehicles Across The U.S." January 31, 2022. Available online: <https://newsroom.nexteraenergy.com/news-releases?item=123840>.

<sup>59</sup> Adler, Alan. "Pilot and Volvo Group add to public electric charging projects." FreightWaves. November 16, 2022. Available online: <https://www.freightwaves.com/news/pilot-and-volvo-group-add-to-public-electric-charging-projects>.

specifically for charging infrastructure for medium- and heavy-duty BEVs.<sup>60</sup>

Domestic manufacturing capacity is also increasing. Department of Energy (DOE) estimates over \$500 million in announced investments have been made to support the domestic manufacturing of BEV charging equipment, with companies planning to produce more than one million BEV chargers in the U.S. each year.<sup>61 62</sup> Workforce development is on the rise. For example, the Siemens Foundation announced they will invest \$30 million over ten years focused on the EV charging sector.<sup>63</sup> As of early 2023, about 20,000 people had been certified through a national Electric Vehicle Infrastructure Training Program.<sup>64 65</sup> These important early actions and market indicators suggest strong growth in charging and refueling ZEV infrastructure in the coming years. See RIA Chapters 1.3 and 1.6 for more information on public and private investments in charging infrastructure.

ii. Summary of Final Standards

Our improved analyses for the final rule continue to show that it is appropriate and feasible to revise the MY 2027 standards promulgated under the HD GHG Phase 2 program for most vehicles, and to set new standards for MYs 2028 through 2032 with year-over-

<sup>60</sup> Lepre, Nicole. "Estimated \$30 Billion Committed to Medium- and Heavy-Duty Charging Infrastructure in the United States." Atlas Public Policy. EV Hub. January 26, 2024. Available online: [https://www.atlasevhub.com/data\\_story/estimated-30-billion-committed-to-medium-and-heavy-duty-charging-infrastructure-in-the-united-states](https://www.atlasevhub.com/data_story/estimated-30-billion-committed-to-medium-and-heavy-duty-charging-infrastructure-in-the-united-states).

<sup>61</sup> DOE. "Building America's Clean Energy Future". 2024. Available online: <https://www.energy.gov/invest>.

<sup>62</sup> U.S. Department of Energy, Vehicle Technologies Office. "FOTW #1314, October 30, 2023: Manufacturers Have Announced Investments of Over \$500 million in More Than 40 American-Made Electric Vehicle Charger Plants". October 30, 2023. Available online: <https://www.energy.gov/eere/vehicles/articles/fotw-1314-october-30-2023-manufacturers-have-announced-investments-over-500>.

<sup>63</sup> Lienert, Paul. "Siemens to invest \$30 million to train U.S. EV charger technicians". Reuters. September 6, 2023. Available online: <https://www.reuters.com/business/autos-transportation/siemens-invest-30-million-train-us-ev-charger-technicians-2023-09-06>.

<sup>64</sup> IBEW. "IBEW Members Answer Call for National Electric Vehicle Program". April 2023. Available online: <https://www.ibew.org/articles/23ElectricalWorker/EW2304/Politics.0423.html>.

<sup>65</sup> The White House. "FACT SHEET: Biden Harris Administration Announces New Standards and Major Progress for a Made-in-America National Network of EV Chargers." February 15, 2023. Available online: <https://www.whitehouse.gov/briefing-room/statements-releases/2023/02/15/fact-sheet-biden-harris-administration-announces-new-standards-and-major-progress-for-a-made-in-america-national-network-of-electric-vehicle-chargers>.

year increases in stringency. In consideration of the opposing concerns raised by commenters, EPA believes it is critical to balance the public health and welfare need for GHG emissions reductions over the long term with the time needed for product development and manufacturing as well as infrastructure development in the near term. After further consideration of the lead times necessary to support both the vehicle technologies' development and deployment and the infrastructure needed, as applicable, under the potential compliance pathway's technology packages described in section ES.C.2.iii, EPA is finalizing GHG emission standards for heavy-duty vehicles that, compared to the proposed standards, include less stringent standards for all vehicle categories in MYs 2027, 2028, 2029, and 2030. The final standards increase in stringency at a slower pace through MYs 2027 to 2030 compared to the proposal, and day cab tractor standards start in MY 2028 and heavy heavy-duty vocational vehicles start in MY 2029 (we proposed Phase 3 standards for day cabs and heavy heavy-duty vocational vehicles starting in MY 2027). As proposed, the final standards for sleeper cabs start in MY 2030 but are less stringent than proposed in that year and in MY 2031, and equivalent in stringency to the proposed standards in MY 2032. Our updated analyses for the final rule show that model years 2031 and 2032 GHG standards in the range of those we requested comment on in the HD GHG Phase 3 NPRM are feasible and appropriate considering feasibility, lead time, cost, and other relevant factors as described throughout this preamble and particularly section II. Specifically, we

are finalizing MY 2031 standards that are on par with the proposal for light and medium heavy-duty vocational vehicles and day cab tractors. Heavy heavy-duty vocational vehicle final standards are less stringent than proposed for all model years, including 2031 and 2032. For MY 2032, we are finalizing more stringent standards than proposed for light and medium heavy-duty vocational vehicles and day cab tractors. Our assessment is that setting this level of standards starting in MY 2032 achieves meaningful GHG emission reductions at reasonable cost, and that heavy-duty vehicle technologies, charging and refueling infrastructure, and critical minerals and related supply chains will be available to support this level of stringency (as many commenters agreed with and provided technical information to support). Our assessment of the final program as a whole is that it takes a balanced and measured approach while still applying meaningful requirements in MY 2027 and later to reducing GHG emissions from the HD sector.

A summary of the final standards can be found in this Executive Summary, with more details on the standards themselves and our supporting analysis found in section II and Chapter 2 of the RIA. The standards for MY 2027 through 2032 and later are presented in Table ES-1 and Table ES-2 with additional tables showing the final custom chassis and heavy-haul tractor standards in section II.F.<sup>66</sup> When compared to the existing Phase 2 standards, the Phase 3 standards begin in MY 2027 with a 13 percent increase

<sup>66</sup> See regulations 40 CFR 1037.105 and 1037.106.

in the stringency of the medium heavy-duty vocational vehicle standards and a 17 percent increase in the light heavy-duty vocational vehicle standards, the Phase 3 day cab tractor standards begin in MY 2028 with an 8 percent increase in stringency over the Phase 2 standards, the heavy heavy-duty vocational standards begin in MY 2029 with a 13 percent increase over Phase 2, and the sleeper cab tractor standards begin in MY 2030 with a 6 percent increase over Phase 2. Each vehicle category then increases in stringency each year, through MY 2032, at which time compared to the Phase 2 program the light heavy-duty vocational standards are a 60 percent increase in stringency of the CO<sub>2</sub> standard, the medium heavy-duty vocational vehicle standards are a 40 percent increase, the day cab standards are a 40 percent increase, the heavy heavy-duty vocational standards are a 30 percent increase, and the sleeper cab standards are a 25 percent increase in the stringency of the standards. As described in section II of this preamble, our analysis shows that the final Phase 3 standards, including revisions to HD GHG Phase 2 CO<sub>2</sub> standards for MY 2027 and the new, progressively more stringent numeric values of the CO<sub>2</sub> standards starting in MYs 2028 through 2032, are feasible and appropriate considering feasibility, lead time, costs, and other relevant factors.

Table ES-1 MY 2027 through 2032 and Later Vocational Vehicle CO<sub>2</sub> Emission Standards (grams/ton-mile) by Regulatory Subcategory (with Phase 2 2024 through 2026 Standards for Reference)

**Table ES-1 MY 2027 through 2032 and Later Vocational Vehicle CO<sub>2</sub> Emission Standards (grams/ton-mile) by Regulatory Subcategory (with Phase 2 2024 through 2026 Standards for Reference)**

Model Year	Subcategory	Compression-ignition			Spark-ignition	
		Light Heavy	Medium Heavy	Heavy Heavy	Light Heavy	Medium Heavy
Phase 2: 2024 through 2026	Urban	385	271	283	432	310
	Multi-Purpose	344	246	242	385	279
	Regional	296	221	194	324	251
Phase 3: 2027	Urban	305	224	269	351	263
	Multi-Purpose	274	204	230	316	237
	Regional	242	190	189	270	219
Phase 3: 2028	Urban	286	217	269	332	256
	Multi-Purpose	257	197	230	299	230
	Regional	227	183	189	255	212
Phase 3: 2029	Urban	268	209	234	314	248
	Multi-Purpose	241	190	200	283	223
	Regional	212	177	164	240	206
Phase 3: 2030	Urban	250	201	229	296	240
	Multi-Purpose	224	183	196	266	216
	Regional	198	170	161	226	199
Phase 3: 2031	Urban	198	178	207	244	217
	Multi-Purpose	178	162	177	220	195
	Regional	157	150	146	185	179
Phase 3: 2032 and later	Urban	147	155	188	193	194
	Multi-Purpose	132	141	161	174	174
	Regional	116	131	132	144	160

Note: Please see section II.F of this preamble for the full set of standards, including for optional custom chassis vehicles.

**Table ES-2 MY 2027 through 2032 and Later Tractor CO<sub>2</sub> Emission Standards (grams/ton-mile) by Regulatory Subcategory (with Phase 2 2024 through 2026 Standards for Reference)**

Model Year	Roof Height	Class 7 All Cab Styles	Class 8 Day Cab	Class 8 Sleeper Cab
Phase 2: 2024 through 2026	Low Roof	99.8	76.2	68.0
	Mid Roof	107.1	80.9	73.5
	High Roof	106.6	80.4	70.7
Phase 3: 2027	Low Roof	96.2	73.4	64.1
	Mid Roof	103.4	78.0	69.6
	High Roof	100.0	75.7	64.3
Phase 3: 2028	Low Roof	88.5	67.5	64.1
	Mid Roof	95.1	71.8	69.6
	High Roof	92.0	69.6	64.3
Phase 3: 2029	Low Roof	84.7	64.6	64.1
	Mid Roof	91.0	68.6	69.6
	High Roof	88.0	66.6	64.3
Phase 3: 2030	Low Roof	80.8	61.7	60.3
	Mid Roof	86.9	65.5	65.4
	High Roof	84.0	63.6	60.4
Phase 3: 2031	Low Roof	69.3	52.8	56.4
	Mid Roof	74.4	56.2	61.2
	High Roof	72.0	54.5	56.6
Phase 3: 2032 and later	Low Roof	57.7	44.0	48.1
	Mid Roof	62.0	46.8	52.2
	High Roof	60.0	45.4	48.2

Note: Please see section II.F for the full set of standards, including for optional custom chassis vehicles.

iii. Updated Technology Packages for Example Potential Compliance Pathways

The standards do not mandate the use of a specific technology, and EPA anticipates that a compliant fleet under the standards would include a diverse range of HD motor vehicle technologies (e.g., transmission technologies, aerodynamic improvements, engine technologies, hybrid technologies, battery electric powertrains, hydrogen fuel cell powertrains, etc.). The technologies that have played (and that the Phase 2 rule projected would play) a fundamental role in meeting the Phase 2 GHG standards will continue to play an important role going forward, as they remain key to reducing the GHG emissions of HD vehicles powered by internal combustion engines. In our assessment that supports the appropriateness and feasibility of these final standards, we developed projected technology packages for potential compliance pathways that could be used to meet each of the final standards.<sup>67</sup> Because our standards are technology neutral and there are

flexibilities built into the ABT program, there are many variations in the exact mix of technologies manufacturers can use to meet the standards, and this mix can include technologies that EPA has not envisioned. We have projected a few compliance pathways with technology packages that are purposely different. One example potential compliance pathway’s projected technology package includes a mix of HD motor vehicle technologies that prevent and control GHG emissions, including technologies for vehicles with ICE and ZEV technologies (Table ES–3). In Table ES–4, we present another example compliance pathway’s technology package that does not include ZEVs but does include a suite of GHG-reducing technologies for vehicles with ICE ranging from: ICE improvements in engine, transmission, drivetrain, aerodynamics, and tire rolling resistance; the use of lower carbon fuels (Compressed Natural Gas (CNG)/Liquified Natural Gas (LNG)); hybrid powertrains (Hybrid Electric Vehicles (HEV) and Plug-in Hybrid Electric Vehicles (PHEV)); and hydrogen-fueled

ICE (H2–ICE). Except for H2–ICE, these technologies exist today and continue to evolve to improve their CO<sub>2</sub> emissions reductions. To demonstrate feasibility and project emissions impacts, costs, benefits, etc. in this final rule, we present a detailed analysis of the compliance pathway represented by the technology packages shown in Table ES–3, which we believe is one reasonable pathway. Details on several additional example potential technology compliance pathways we considered can be found in section II.F.4 and RIA Chapter 2.11, and details on our projected technology mix in a “reference” scenario that represents the United States without the final standards can be found in section V and RIA Chapter 4. EPA emphasizes that its standards are performance-based, and manufacturers are not required to use particular technologies to meet the standards. Tables ES–3 and ES–4 are just two examples of potential technology compliance pathways and do not reflect a requirement of how manufacturers will ultimately meet the standards finalized in this rule.

**Table ES-3 Example 1 Projected Percent Mix of Vehicle Technologies that Support the Feasibility of the Phase 3 Standards**

Regulatory Subcategory Grouping	MY 2027		MY 2028		MY 2029		MY 2030		MY 2031		MY 2032	
	ZEV	ICEV	ZEV	ICEV	ZEV	ICEV	ZEV	ICEV	ZEV	ICEV	ZEV	ICEV
Light Heavy-Duty Vocational	17%	83%	22%	78%	27%	73%	32%	68%	46%	54%	60%	40%
Medium Heavy-Duty Vocational	13%	87%	16%	84%	19%	81%	22%	78%	31%	69%	40%	60%
Heavy Heavy-Duty Vocational	N/A, begins in MY 2029				13%	87%	15%	85%	23%	77%	30%	70%
Short-Haul (Day Cab) Tractors	N/A, begins in MY 2028		8%	92%	12%	88%	16%	84%	28%	72%	40%	60%
Long-Haul (Sleeper Cab) Tractors	N/A, begins in MY 2030						6%	94%	12%	88%	25%	75%

Note: Please see section II.F for the full set of technology packages, including for optional custom chassis vehicles.

<sup>67</sup> As further explained in sections I and II (including II.G), EPA is required by law to assess feasibility and compliance costs of standards issued pursuant to CAA section 202(a), and thus practically must demonstrate a potential means of complying with the standards in order to do so (e.g., a potential compliance pathway’s projected

technology packages that manufacturers may, but are not required, to utilize). Long-standing case law regarding EPA’s CAA section 202(a) authority supports the necessity of this approach. See *NRDC v. EPA*, 655 F. 2d 321, 332 (D.C. Cir. 1981) (indicating that EPA is to state the engineering basis underlying a section 202 standard (i.e., the

technology package which could be utilized to meet a standard), indicate potential impediments to that technology package’s feasibility, and plausibly explain how those impediments could be resolved within the lead time afforded).



**Table ES-4 Example 2 Projected Percent Mix of Vehicle Technologies that Support the Feasibility of the Phase 3 MY 2027 and 2032 Standards**

Regulatory Subcategory Grouping	MY 2027					MY 2032				
	ICEV	Natural Gas	HEV	PHEV	H2-ICE	ICEV	Natural Gas	HEV	PHEV	H2-ICE
Light Heavy-Duty Vocational	33%	5%	52%	0%	0%	1%	5%	40%	0%	24%
Medium Heavy-Duty Vocational	48%	5%	40%	0%	0%	18%	5%	44%	0%	13%
Heavy Heavy-Duty Vocational	N/A, begins in MY 2029					42%	5%	27%	0%	12%
Short-Haul (Day Cab) Tractors	N/A, begins in MY 2028					39%	5%	20%	0%	26%
Long-Haul (Sleeper Cab) Tractors	N/A, begins in MY 2030					64%	5%	10%	0%	17%

Note: The Heavy Heavy-Duty vocational vehicle, Short-Haul (Day Cab) tractor, and Long-Haul (Sleeper Cab) tractor standards are unchanged in MY 2027.

iv. Revisions to Advanced Technology Vehicle Credit Multipliers

Along with retaining EPA’s historical approach to setting performance-based standards and providing manufacturers flexibility in meeting the standards by allowing them to choose their own mix of vehicle technologies, we are retaining and did not reopen the general structure of the Averaging, Banking and Trading (ABT) program, which allows manufacturers further flexibility in meeting standards using averaging provisions. In other words, consistent with EPA’s practice for over fifty years of setting emissions standards for HD vehicles, we are retaining the existing regulatory scheme that does not require each vehicle to meet the standards individually and instead allows manufacturers to meet the standards on average within each weight class of their fleet.<sup>68</sup> As described in section III.A of this preamble, we are finalizing updates to the advanced technology incentives in the ABT program for HD GHG Phase 2 for PHEVs, BEVs, and FCEVs. As further explained in section III, after consideration of comments, we are retaining the advanced technology vehicle credit multipliers for PHEV, BEV, and FCEV technologies through MY 2027, consistent with the previously promulgated HD GHG Phase 2 program. In order to ensure meaningful vehicle GHG emission reductions under the Phase 3 program, we are limiting the period over which manufacturers can use the multiplier portion of credits

<sup>68</sup> As further described in section III, as has been the case since the ABT program was first promulgated, although manufacturers choosing to use ABT as a compliance strategy must assure that their vehicle families comply with the standard on average, each individual vehicle is certified to an individual limit (called a Family Emission Limit) as well.

earned from advanced technologies. However, in recognition that the final HD GHG Phase 3 standards will require meaningful investments from manufacturers to reduce GHG emissions from HD vehicles, we requested comment on and are finalizing certain additional transitional flexibilities to assist manufacturers in the implementation of Phase 3. See section III of this preamble for further details.

v. Commitment to Engagement and Monitoring Elements of Phase 3 Compliance and Supporting Technology and Infrastructure Development

As we noted in the HD GHG Phase 3 NPRM, EPA has a vested interest in monitoring industry’s performance in complying with mobile source emission standards, including the highway heavy-duty industry. In fact, EPA already monitors and reports out industry’s performance through a range of approaches, including publishing industry compliance reports (such as has been done during the heavy-duty GHG Phase 1 program).<sup>69</sup> After consideration of the divergent comments received on the topic of collecting and monitoring ZEV infrastructure during the implementation of the Phase 3 standards, as further described in section II, we are committing in this final rule to actively engage and monitor both manufacturer compliance and the major elements of heavy-duty technology and supporting infrastructure development. EPA, in consultation with other Federal

<sup>69</sup> See EPA Reports EPA-420-R-21-001B covering Model Years 2014–2018, and EPA report EPA-420-R-22-028B covering Model Years 2014–2020, available online at <https://www.epa.gov/compliance-and-fuel-economy-data/epa-heavy-duty-vehicle-and-engine-greenhouse-gas-emissions>.

agencies, will issue periodic reports reflecting collected information. These reports will track HD electric charging and hydrogen refueling infrastructure buildout throughout Phase 3 implementation as well as an evaluation of zero and low GHG-emitting HD vehicle production and the evolution of the HD battery production and material supply, including supply of critical minerals. Based on these reports, as appropriate and consistent with CAA section 202(a) authority, EPA may decide to issue guidance documents, initiate a rulemaking to consider modifications to the Phase 3 rule, or make no changes to the Phase 3 rule program. We are not finalizing any mechanisms for including a self-adjusting linkage between the standards’ stringency and ZEV infrastructure as requested by some industry stakeholders. Further details on EPA’s Phase 3 rule implementation engagement, data collection and monitoring and reporting commitments can be found in section II.B.2 of this preamble.

D. Impacts of the Standards

Our estimated emission impacts, average per-vehicle costs, monetized program costs, and monetized benefits of the final program are summarized in this section and detailed in sections IV through VIII of the preamble and Chapters 3 through 8 of the RIA. EPA notes that, consistent with CAA section 202(a)(1) and (2), in evaluating potential GHG standards, we carefully weigh the statutory factors, including GHG emissions impacts of the GHG standards, and the feasibility of the standards (including cost of compliance and available lead time).

We monetize benefits of the GHG standards and evaluate costs in part to

better enable a comparison of costs and benefits pursuant to E.O. 12866, but we recognize that there are benefits that we are currently unable to fully quantify and monetize. EPA’s consistent practice has been to set standards to achieve improved air quality consistent with CAA section 202(a), and not to rely on cost-benefit calculations, with their uncertainties and limitations, in identifying the appropriate standards. Nonetheless, our conclusion that the estimated benefits exceed the estimated costs of the final program reinforces our view that the GHG standards represent an appropriate weighing of the statutory factors and other relevant considerations.

Our analysis of emissions impacts accounts for downstream emissions, *i.e.*, from emission processes such as engine combustion, engine crankcase exhaust, vehicle evaporative emissions, vehicle refueling emissions, and brake and tire wear. Vehicle technologies would also affect emissions from upstream sources, *i.e.*, emissions that are attributable to a vehicle’s operation but not the vehicle itself, for example, electricity generation and the refining and distribution of fuel. Our analyses include emissions impacts from electrical generating units (EGUs) and refinery emission impacts.<sup>70</sup>

The estimated impacts summarized in this section are based on our projection of a scenario that represents the United States with the final standards in place, relative to our projection of a “reference” scenario that represents the United States without the final standards. For a similar estimate for the alternative standards, please see preamble section IX. As suggested by many commenters, and as EPA suggested at proposal (88 FR 25989), we updated our reference scenario between the proposal and this final rule to include California’s ACT program implementation in California and in the states that have adopted the ACT rule

under CAA section 177, thus increasing the amount of ZEV technology in our projection of the United States without the final standards in place.<sup>71</sup> Further, we improved our projections of the rate of expected ZEV adoption across vehicle categories for the reference scenario, the result of which in the modeled compliance pathway was increased projected adoption in the light heavy-duty vocational vehicle subcategory and decreased adoption in other subcategories compared to the reference scenario in the proposal. These updates to the reference scenario resulted in changes to the estimated numeric values of emissions and costs as shown but reflect the same general expected impacts of the standards as we projected at the time of proposal, *i.e.*, significant reductions in downstream GHG emissions, reductions in GHGs from lower demand for onroad fuels and therefore reduced emissions from fuel refineries, and increases in GHG emissions from EGUs (which we expect to decline over time as the electricity grid becomes cleaner). This same trend is expected for non-GHG pollutants as well, which are affected to the extent that zero- or lower-non-GHG emitting technologies are used to meet the GHG standards, *i.e.*, we project significant reductions in downstream emissions of non-GHG pollutants, reductions in non-GHG pollutants resulting from lower demand for onroad fuels and therefore reduced emissions from fuel refineries, and increases in non-GHG pollutant emissions from EGUs (which we expect to decrease over time as previously noted).

As seen in Table ES–5, through 2055 the program will result in significant downstream GHG emission reductions—approximately 1.4 billion metric tons in reduced CO<sub>2</sub>-equivalent emissions.<sup>72</sup> From calendar years 2027 through 2055, we project a cumulative increase of approximately 0.39 billion

metric tons of CO<sub>2</sub>-equivalent emissions from EGUs as a result of the increased demand for electricity associated with the rule. We also project reductions in CO<sub>2</sub>-equivalent emissions from refineries on the order of 0.013 billion metric tons during this time period. Considering both downstream and upstream cumulative emissions from calendar years 2027 through 2055 (a year when most of the regulated fleet will consist of HD vehicles subject to the Phase 3 standards due to fleet turnover), the standards will achieve approximately 1 billion metric tons in net CO<sub>2</sub>-equivalent emission reductions (see section V of this preamble and Chapter 4 of the RIA for more detail). Following improvements to our technical analysis as described in more detail in sections II and V of this preamble, we remodeled the GHG emission reductions from the proposed standards, and the results show the reductions from the final rule are close to but greater than projected reductions from the proposed standards (*e.g.*, net reductions are 998 million metric ton for the proposed standards). As summarized in section C2.ii of the Executive Summary and detailed in section II of this preamble, the final standards are less stringent and increase in stringency at a slower pace compared to the proposal in the early model years of the program, but the later model year final standards are more stringent than proposed for light and medium heavy-duty vocational vehicles and day cab tractors. This final rule’s GHG emission reductions will make an important contribution to efforts to limit climate change and its anticipated impacts. These GHG reductions will benefit all U.S. residents, including populations such as people of color, low-income populations, indigenous peoples, and/or children that may be especially vulnerable to various forms of damages associated with climate change.

**Table ES-5 Cumulative 2027–2055 Net GHG Emission Impacts<sup>a</sup> (in MMT) Reflecting the Final Standards Relative to the Reference Case**

Pollutant	Downstream	EGU	Refineries	Net
Carbon Dioxide (CO <sub>2</sub> )	-1,347	391	-13	-969
Methane (CH <sub>4</sub> )	-0.127	0.018	-0.001	-0.109
Nitrous Oxide (N <sub>2</sub> O)	-0.199	0.002	0.000	-0.197
CO <sub>2</sub> Equivalent (CO <sub>2</sub> e)	-1,404	393	-13	-1,025

<sup>a</sup> We present emissions reductions as negative numbers and emission increases as positive numbers.

<sup>70</sup> We are continuing and are not reopening the existing approach taken in both HD GHG Phase 1 and Phase 2, that compliance with the vehicle exhaust CO<sub>2</sub> emission standards is based solely on CO<sub>2</sub> emissions from the vehicle. Indeed, all of our

vehicle emission standards are based on vehicle emissions.

<sup>71</sup> EPA granted California’s waiver request on March 30, 2023, which left EPA insufficient time to develop an alternative reference case for the proposal. 88 FR 25989.

<sup>72</sup> Note that these reductions are lower in the final rule than the proposal primarily due to the increased number of ZEVs considered in the reference case, see section V of this preamble for details.

In our modeled potential compliance pathway, we project that the GHG emission standards will lead to an increase in HD ZEVs relative to our reference case (*i.e.*, without the rule), which will also result in downstream reductions of vehicle emissions of non-GHG pollutants that contribute to ambient concentrations of ozone, particulate matter (PM<sub>2.5</sub>), nitrogen dioxide (NO<sub>2</sub>), CO, and air toxics. Exposure to these non-GHG pollutants is linked to adverse human health impacts such as premature death as well as other adverse public health and environmental effects (see section VI). As shown in Table ES-6, in 2055, we estimate a decrease in emissions from all criteria pollutants modeled (*i.e.*, NO<sub>x</sub>, PM<sub>2.5</sub>, VOC, and SO<sub>2</sub>) from downstream sources. The reductions in non-GHG emissions from vehicles will reduce air pollution near roads. As

described in section VI of this preamble, there is substantial evidence that people who live or attend school near major roadways are more likely to be of a non-White race, Hispanic ethnicity, and/or low socioeconomic status. In addition, emissions from HD vehicles and engines can significantly and adversely affect individuals living near truck freight routes. Based on a study EPA conducted of people living near truck routes, an estimated 72 million people live within 200 meters of a truck freight route.<sup>73</sup> Relative to the rest of the population, people of color and those with lower incomes are more likely to live near truck routes.<sup>74</sup> In addition, children who attend school near major roads are disproportionately more highly represented by children of color and children from low-income households.<sup>75</sup>

Table ES-6 also shows impacts on EGU and refinery emissions. Similar to GHG emissions, we project that non-GHG emissions from EGUs will increase in the near term as a result of the increased demand for electricity associated with the rule, and we expect those projected impacts to decrease over time as the electricity grid becomes cleaner. We project reductions in non-GHG emissions from refineries.<sup>76</sup> We project net reductions in NO<sub>x</sub>, VOC, and SO<sub>2</sub> emissions in 2055. Although there is a small net increase in direct PM<sub>2.5</sub> emissions in 2055, ambient PM<sub>2.5</sub> is formed from emissions of direct PM<sub>2.5</sub> as well as emissions of other precursors such as NO<sub>x</sub> and SO<sub>2</sub>. We project overall PM<sub>2.5</sub>-related benefits based on the contribution of emissions from each of these pollutants (see Table ES-8). See section V of this preamble and RIA Chapter 4 for more details.

**Table ES-6 Annual Net Impacts<sup>a</sup> on Non-GHG Pollutant Emissions from the Final Standards in Calendar Years 2055, Relative to Reference Case**

Pollutant	Downstream (U.S. Short Tons)	EGU (U.S. Short Tons)	Refinery (U.S. Short Tons)	Net Impact (U.S. Short Tons)
Oxides of Nitrogen (NO <sub>x</sub> )	-54,268	1,520	-304	-53,051
Primary Exhaust PM <sub>2.5</sub>	-331	513	-70	113
Volatile Organic Compounds (VOC)	-7,242	196	-226	-7,272
Sulfur Dioxide (SO <sub>2</sub> )	-270	69	-94	-295

<sup>a</sup> We present emissions reductions as negative numbers and emission increases as positive numbers.

EPA believes the non-GHG emissions reductions of this rule provide important health benefits to the 72 million people living near truck routes and even more broadly over the longer term. We note that the agency has broad authority to regulate emissions from the power sector (*e.g.*, the mercury and air toxics standards, and new source performance standards), as do the States and EPA through cooperative federalism programs (*e.g.*, in response to PM National Ambient Air Quality Standards (NAAQS) implementation requirements, interstate transport, emission guidelines, and regional haze),<sup>77</sup> and that EPA reasonably may address air pollution incrementally across multiple rulemakings, particularly across multiple industry sectors. For example,

EPA has separately proposed new source performance standards and emission guidelines for greenhouse gas emissions from fossil fuel-fired power plants, which would also reduce emissions of criteria air pollutants such as PM<sub>2.5</sub> and SO<sub>2</sub> (88 FR 33240, May 23, 2023).<sup>78</sup>

In general, the final rule cost analysis methodology mirrors the approach we took for the proposal, but with a number of important updates to our modeling approach and the data used in our modeling projections. More details on specific updates after consideration of comments and new data can be found in sections II and IV of this preamble, but we note here that our final rule analysis was conducted using the latest dollar value, 2022 dollars (2022\$),

which represents an update from the 2021 dollars used in the NPRM analysis. We also note that updates to our reference scenario have lowered the overall costs and benefits of the final standards, as described briefly in this Executive Summary and in more detail in sections IV through VIII of this preamble. The decrease is attributable to the increase in the number of ZEVs in the reference case.

We estimate that for calendar years 2027 through 2055 and at an annualized 2 percent discount rate, costs to manufacturers will result in a cost savings of \$0.19 billion dollars before considering the IRA battery tax credits. With those battery tax credits, which we estimate to be \$0.063 billion, the cost to manufacturers of compliance with the

<sup>73</sup> U.S. EPA (2021). Estimation of Population Size and Demographic Characteristics among People Living Near Truck Routes in the Conterminous United States. Memorandum to the Docket EPA-HQ-OAR-2019-0055.

<sup>74</sup> See section VI.D of this preamble for additional discussion on our analysis of environmental justice impacts of this final rule.

<sup>75</sup> Kingsley, S., Eliot, M., Carlson, L. et al. Proximity of U.S. schools to major roadways: a nationwide assessment. *J Expo Sci Environ*

*Epidemiol* 24, 253–259 (2014). <https://doi.org/10.1038/jes.2014.5>.

<sup>76</sup> We note here that there is uncertainty surrounding how refinery activity would change in response to lower domestic demand for liquid transportation fuels and in response to comments received on the proposal, the estimates in Table ES-6 reflect the assumption that half of the projected drop in domestic fuel demand would be offset by an increase in exports.

<sup>77</sup> See also CAA section 116.

<sup>78</sup> New Source Performance Standards for Greenhouse Gas Emissions From New, Modified, and Reconstructed Fossil Fuel-Fired Electric Generating Units; Emission Guidelines for Greenhouse Gas Emissions From Existing Fossil Fuel-Fired Electric Generating Units; and Repeal of the Affordable Clean Energy Rule. 88 FR 33240, May 23, 2023. <https://www.federalregister.gov/documents/2023/05/23/2023-10141/new-source-performance-standards-for-greenhouse-gas-emissions-from-new-modified-and-reconstructed>.

program will result in a cost savings of \$0.25 billion. The manufacturer cost of compliance with the rule on a per-vehicle basis are shown in Table ES-7. We estimate that the MY 2032 fleet average per-vehicle cost to manufacturers by regulatory group will range from a cost savings of between \$700 and \$3,000 per vehicle for vocational vehicles to costs of between \$3,200 and \$10,800 per tractor. EPA

notes the projected fleet-average costs per-vehicle for this rule are less than the fleet average per-vehicle costs projected for the HD GHG Phase 2 MY 2027 standards which EPA found to be reasonable under our statutory authority, where the tractor standards were projected to cost between \$12,750 and \$17,125 (2022\$) per vehicle and the vocational vehicle standards were projected to cost between \$1,860 and

\$7,090 (2022\$) per vehicle.<sup>79</sup> For this action, EPA finds that the expected additional vehicle costs are reasonable considering the related GHG emissions reductions.<sup>80</sup> EPA emphasizes again that manufacturers will choose their pathway for compliance and the pathway modeled here is just one of many potential compliance pathways.

**Table ES-7 Manufacturer Costs to Meet the Proposed MY 2032 Standards Relative to the Reference Case<sup>a</sup> (2022\$)**

Regulatory Group <sup>b</sup>	Modeled Pathway Incremental ZEV Adoption Rate in Technology Package	Per-ZEV Manufacturer RPE on Average	Fleet-Average Per-Vehicle Manufacturer RPE <sup>c</sup>
Light Heavy-Duty Vocational Vehicles	30%	-\$9,800	-\$3,000
Medium Heavy-Duty Vocational Vehicles	20%	-\$5,000	-\$1,000
Heavy Heavy-Duty Vocational Vehicles	16%	-\$4,000	-\$700
Short-Haul (Day Cab) Tractors	30%	\$10,800	\$3,200
Long-Haul (Sleeper Cab) Tractors	20%	\$53,300	\$10,800

<sup>a</sup> Values rounded to the nearest \$100 for values above \$100, and nearest \$10 for values below \$100.

<sup>b</sup> The average costs represent the average across the regulatory group. For example, the first row represents the average across all light heavy-duty (LHD) vocational vehicles.

<sup>c</sup> RPE = Retail Price Equivalent.

The GHG standards will reduce adverse impacts associated with climate change and exposure to non-GHG pollutants and thus will yield significant benefits, including those we can monetize and those we are unable to quantify. Table ES-8 summarizes EPA's estimates of total monetized discounted costs, operational savings, and benefits. In our proposal, EPA used interim Social Cost of GHGs (SC-GHG) values developed for use in benefit-cost analyses until updated estimates of the impacts of climate change could be developed based on the best available science and economics. In response to recent advances in the scientific literature on climate change and its economic impacts, incorporating recommendations made by the National Academies of Science, Engineering, and Medicine<sup>81</sup> (National Academies, 2017), and to address public comments on this

topic, for this final rule we are using updated SC-GHG values. EPA presented these updated values in a sensitivity analysis in the December 2022 Oil and Gas Rule RIA which underwent public comment on the methodology and use of these estimates as well as external peer review.<sup>82</sup> After consideration of public comment and peer review, EPA issued a technical report signed by the EPA Administrator on December 2, 2023, updating the estimates of SC-GHG in light of recent information and advances.<sup>83</sup> This is discussed further in preamble section VII and RIA Chapter 7.

The results presented in Table ES-8 project the monetized environmental and economic impacts associated with the program during each calendar year through 2055. EPA estimates that the annualized value of monetized net benefits to society at a 2 percent discount rate will be approximately \$13

billion through the year 2055, roughly 12 times the cost in vehicle technology and associated electric vehicle supply equipment (EVSE) combined. Regarding social costs, EPA estimates that the cost of vehicle technology (not including the vehicle or battery tax credits) and EVSE at depots<sup>84</sup> will be approximately \$1.1 billion. The HD industry will save approximately \$3.5 billion in operating costs (e.g., savings that come from less liquid fuel used, lower maintenance and repair costs for ZEV technologies as compared to ICE technologies, etc.). The program will result in significant social benefits including \$10 billion in climate benefits (with the average SC-GHG at a 2 percent near-term Ramsey discount rate) and \$0.3 billion in estimated benefits attributable to changes in emissions of PM<sub>2.5</sub> precursors. Finally, the benefits due to reductions in energy security externalities caused by U.S.

<sup>79</sup> The Phase 2 tractor MY 2027 standard cost increments were projected to be between \$10,200 and \$13,700 per vehicle in 2013\$ (81 FR 73621). The Phase 2 vocational vehicle MY 2027 standards were projected to cost between \$1,486 and \$5,670 per vehicle in 2013\$ (81 FR 73718).

<sup>80</sup> For illustrative purposes, these average costs range between an approximate 0.03 percent decrease for light-heavy vocational vehicles up to a 6 percent increase for long-haul tractors based on a minimum vehicle price of \$100,000 for vocational vehicles and \$190,000 for long-haul tractors (see section II.G.2 of this preamble). We also note that these average upfront costs are taken across the HD

vehicle fleet and are not meant as an indicator of average price increase.

<sup>81</sup> National Academies of Sciences, Engineering, and Medicine. 2017. *Valuing Climate Damages: Updating Estimation of the Social Cost of Carbon Dioxide*. Washington, DC: The National Academies Press. <https://doi.org/10.17226/24651>.

<sup>82</sup> Standards of Performance for New, Reconstructed, and Modified Sources and Emissions Guidelines for Existing Sources: Oil and Natural Gas Sector Climate Review. 87 FR 74702.

<sup>83</sup> Supplementary Material for the Regulatory Impact Analysis for the Supplemental Proposed Rulemaking, "Standards of Performance for New, Reconstructed, and Modified Sources and

Emissions Guidelines for Existing Sources: Oil and Natural Gas Sector Climate Review" EPA, 2022. Docket ID No. EPA-HQ-OAR-2021-0317. Available at: [https://www.epa.gov/system/files/documents/2023-12/eo12866\\_oil-and-gas-nsp-eg-climate-review-2060-av16-ria-20231130.pdf](https://www.epa.gov/system/files/documents/2023-12/eo12866_oil-and-gas-nsp-eg-climate-review-2060-av16-ria-20231130.pdf).

<sup>84</sup> EVSE costs include hardware and installation costs for electric vehicle supply equipment at depots. Costs for upgrades to the distribution system are incorporated in the operating costs (specifically within \$/kWh charging costs). We also estimate infrastructure costs for vehicles we project to use public charging. See RIA 2.4.4 and 2.6 for more information.

petroleum consumption and imports will be approximately \$0.45 billion under the program. A more detailed

description and breakdown of these benefits can be found in section VIII of

the preamble and Chapters 7 and 8 of the RIA.

**Table ES-8 Monetized Discounted Costs, Benefits, and Net Benefits of the Program for Calendar Years 2027 through 2055 (Billions of 2022\$)<sup>a,b,c</sup>**

	CY 2055	PV, 2%	PV, 3%	PV, 7%	AV, 2%	AV, 3%	AV, 7%
Vehicle Technology Costs	-\$0.59	-\$4.2	-\$3.2	-\$1	-\$0.19	-\$0.17	-\$0.083
EVSE <sup>d</sup> Costs	\$1.1	\$28	\$25	\$15	\$1.3	\$1.3	\$1.3
Operational Savings	\$7.4	\$76	\$63	\$32	\$3.5	\$3.3	\$2.6
Energy Security Benefits	\$0.8	\$9.8	\$8.2	\$4.2	\$0.45	\$0.43	\$0.34
Climate Benefits	\$22	\$220	\$220	\$220	\$10	\$10	\$10
Non-GHG Benefits	\$1.9	\$6.5	\$4.2	\$(0.4)	\$0.3	\$0.22	\$(0.032)
Benefits	\$25	\$240	\$240	\$230	\$11	\$11	\$11
Net Benefits	\$32	\$290	\$280	\$250	\$13	\$13	\$12

<sup>a</sup> Values rounded to two significant figures; totals may not sum due to rounding. Present and annualized values are based on the stream of annual calendar year costs and benefits included in the analysis (2027 – 2055) and discounted back to year 2027. Net benefits reflect the operational savings plus benefits minus costs.

<sup>b</sup> Climate benefits are based on reductions in GHG emissions and are calculated using three different SC-GHG estimates that assume either a 1.5 percent, 2.0 percent, or 2.5 percent near-term Ramsey discount rate. See EPA’s Report on the Social Cost of Greenhouse Gases: Estimates Incorporating Recent Scientific Advances (EPA, 2023). For presentational purposes in this table, we use the climate benefits associated with the SC-GHG under the 2-percent near-term Ramsey discount rate. All other costs and benefits are discounted using either a 2-percent, 3-percent, or 7-percent constant discount rate. For further discussion of the SC-GHGs and how EPA accounted for these estimates, please refer to Chapter 7 of the RIA that accompanies this preamble.

<sup>c</sup> Monetized non-GHG health benefits are based on PM<sub>2.5</sub>-related benefit-per-ton (BPT) values. To calculate net benefits, we use the monetized suite of total avoided PM<sub>2.5</sub>-related health effects that includes avoided deaths based on the Pope III et al., 2019 study, which is the larger of the two PM<sub>2.5</sub> health benefits estimates presented in section VII.B of this preamble. The annual PM<sub>2.5</sub> health benefits estimate presented in the CY 2055 column reflects the value of certain avoided health outcomes, such as avoided deaths, that are expected to accrue over more than a single year discounted using a 3-percent discount rate. Depending on the discount rate used, the present and annualized value of the stream of PM<sub>2.5</sub> benefits may either be positive or negative.

<sup>d</sup> Electric Vehicle Supply Equipment.

Regarding the costs to purchasers as shown in Table ES-9, for the final program we estimated the average upfront incremental cost to purchase a new MY 2032 HD ZEV relative to a comparable ICE vehicle meeting the Phase 2 MY 2027 standards for a vocational ZEV and EVSE, a short-haul tractor ZEV and EVSE, and a long-haul tractor ZEV. These incremental costs account for the IRA tax credits, specifically battery and vehicle tax

credits and tax credits applicable to EVSE installation and infrastructure, as discussed in section II.E.4 and RIA Chapter 2. We also estimated the operational savings each year (*i.e.*, savings that come from the lower costs to operate, maintain, and repair ZEV technologies) and payback period (*i.e.*, the year the initial cost increase would pay back). Table ES-9 shows that for the vocational vehicle ZEVs, short-haul tractor ZEVs, and long-haul tractor ZEVs

the incremental upfront costs (after the tax credits) are recovered through operational savings such that payback occurs between two and four years on average for vocational vehicles, after two years for short-haul tractors and after five years on average for long-haul tractors. We discuss this in more detail in sections II and IV of this preamble and RIA Chapters 2 and 3.

**Table ES-9: MY 2032 Estimated Average Per-Vehicle Purchaser Upfront Cost and Annual Savings Difference Between BEV/FCEV and ICE Technologies for the Program (2022\$)<sup>a, b, c</sup>**

Regulatory Group	Upfront Incremental Vehicle Cost Difference (Including Tax Credits)	Upfront EVSE <sup>d</sup> Costs on Average (Including Tax Credits)	Total Incremental Upfront Costs on Average Including Taxes and Tax Credits	Annual Incremental Operating Costs on Average	Payback Period (year) on Average
Light Heavy-Duty Vocational Vehicles	-\$10,300	\$11,700	\$1,500	-\$3,700	2
Medium Heavy-Duty Vocational Vehicles	-\$5,600	\$15,300	\$9,700	-\$5,100	3
Heavy Heavy-Duty Vocational Vehicles	-\$11,700	\$46,200	\$34,500	-\$10,500	4
Short-Haul (Day Cab) Tractors	-\$1,500	\$5,900	\$4,400	-\$5,500	2
Long-Haul (Sleeper Cab) Tractors	\$22,400	\$0	\$22,400	-\$8,300	5

<sup>a</sup> Undiscounted dollars.

<sup>b</sup> Values rounded to the nearest \$100 for values above \$100, and nearest \$10 for values below \$100.

<sup>c</sup> The average costs and payback periods represent the sales weighted average across the regulatory group, for example the first row represents the average across all LHD vocational vehicles.

<sup>d</sup> Electric Vehicle Supply Equipment.

*E. Coordination With Federal and State Partners*

EPA has coordinated and consulted with DOT/NHTSA, both on a bilateral level during the development of this program as well as through the interagency review of the action led by the Office of Management and Budget. EPA has set some previous heavy-duty vehicle GHG emission standards in joint rulemakings where NHTSA also established heavy-duty fuel efficiency standards. EPA notes that there is no statutory requirement for joint rulemaking, that the agencies have different statutory mandates and that their respective programs have always reflected those differences. As the Supreme Court has noted, “EPA has been charged with protecting the public’s ‘health’ and ‘welfare,’ a statutory obligation wholly independent of DOT’s mandate to promote energy efficiency.”<sup>85</sup> Although there is no statutory requirement for EPA to consult with NHTSA, EPA has consulted with NHTSA in the development of this program. For example, staff of the two agencies met frequently to discuss various technical issues and to share technical information. While assessing safety implications of this rule for the NPRM, EPA consulted with NHTSA. EPA further coordinated with NHTSA regarding safety implications of this rule, including EPA’s response to safety

related comments and identifying updates, for the final rule.<sup>86</sup>

EPA also has consulted with other Federal agencies in developing this rule and the light-duty vehicles GHG rulemaking, including the Federal Energy Regulatory Commission (FERC), the Joint Office for Energy and Transportation, the Department of Energy and several National Labs. EPA consulted with FERC on this rulemaking regarding potential impacts of these rulemakings on bulk power system reliability and related issues.<sup>87</sup> EPA collaborated with DOE and Argonne National Laboratory on battery cost analyses and critical minerals forecasting. EPA, National Renewable Energy Laboratory (NREL), and DOE collaborated on forecasting the development of a national charging infrastructure and projecting regional charging demand for input into EPA’s power sector modeling. EPA also coordinated with the Joint Office of Energy and Transportation on charging infrastructure. EPA and the Lawrence Berkeley National Laboratory collaborated on issues of consumer acceptance of plug-in electric vehicles. EPA and the Oak Ridge National Laboratory collaborated on energy

security issues. EPA also participated in the Federal Consortium for Advanced Batteries led by DOE and the Joint Office of Energy and Transportation. EPA and DOE also have entered into a Joint Memorandum of Understanding to provide a framework for interagency cooperation and consultation on electric sector resource adequacy and operational reliability.<sup>88</sup> EPA consulted with the Department of Labor (DOL) and DOE on labor and employment initiatives involving the battery and vehicle electrification spaces, and DOL provided a memorandum to EPA containing an overview of numerous Federal Government initiatives focused on these areas.<sup>89</sup> EPA also consulted with NHTSA on potential safety issues and NHTSA provided a number of studies to us concerning electric vehicle safety. In addition, EPA consulted with the Department of State on the Federal Government’s initiatives concerning supply chains for critical minerals.

EPA has also engaged with the California Air Resources Board on technical issues in developing this program. EPA has considered certain aspects of the CARB ACT rule, as

<sup>88</sup> Joint Memorandum on Interagency Communication and Consultation on Electric Reliability, U.S. Department of Energy and U.S. Environmental Protection Agency, March 8, 2023.

<sup>89</sup> See Memorandum from Employment and Training Administration (ETA), Office of Assistant Secretary for Policy (OASP), Office of the Solicitor (SOL) at the U.S. Department of Labor to EPA re Labor/Employment Initiatives in the Battery/Vehicle Electrification Space (February 2024), which is available in the docket for this action.

<sup>85</sup> *Massachusetts v. EPA*, 549 U.S. at 532.

<sup>86</sup> Landgraf, Michael. Memorandum to docket EPA-HQ-OAR-2022-0985. Summary of NHTSA Safety Communication. February 2024.

<sup>87</sup> Although not a Federal agency, EPA also consulted with the North American Electric Reliability Corporation (NERC). NERC is the Electric Reliability Organization for North America, subject to oversight by FERC.

discussed elsewhere in this document. We also have engaged with other states, including members of the National Association of Clean Air Agencies, the Association of Air Pollution Control Agencies, the Northeast States for Coordinated Air Use Management, and the Ozone Transport Commission.

*F. Stakeholder Engagement*

EPA conducted extensive engagement with a diverse range of interested stakeholders in developing this final rule, including labor unions, states, industry, environmental justice organizations and public health experts. In addition, we have engaged with environmental NGOs, vehicle manufacturers, technology suppliers, dealers, utilities, charging providers, tribal governments, and other organizations. For example, in April–May 2022, EPA held a series of engagement sessions with organizations representing all of these stakeholder groups so that EPA could hear early input in developing its proposal. EPA has continued engagement with stakeholders throughout the development of this rule, throughout the public comment period and into the development of this final rule.<sup>90</sup>

**I. Statutory Authority for the Final Rule**

This section summarizes the statutory authority for the final rule. Statutory authority for the GHG standards EPA is finalizing is found in CAA section 202(a)(1)–(2), 42 U.S.C. 7521(a)(1)–(2), which requires EPA to establish standards applicable to emissions of air pollutants from new motor vehicles and engines which in the Administrator’s judgment cause or contribute to air pollution which may reasonably be anticipated to endanger public health or welfare. Additional statutory authority for the action is found in CAA sections 202–209, 216, and 301, 42 U.S.C. 7521–7543, 7550, and 7601.

Section I.A overviews the text of the relevant statutory provisions read in their context. We discuss the statutory definition of “motor vehicles” in section 216 of the Act, EPA’s authority to establish emission standards for such motor vehicles in section 202, and authorities related to compliance and testing in sections 203, 206, and 207.

Section I.B addresses comments regarding our legal authority to consider a wide range of technologies, including electrified technologies that completely prevent vehicle tailpipe emissions. EPA’s standard-setting authority under

section 202 is not limited to any specific type of emissions control technology, such as technologies applicable only to ICE vehicles; rather, the Agency must consider all technologies that reduce emissions from motor vehicles—including zero-emissions vehicle (ZEV) technologies that allow for complete prevention of emissions such as battery electric vehicle (BEV) and fuel-cell electric vehicle (FCEV) technologies—in light of the lead time provided and the costs of compliance. Many commenters, including the main trade group representing regulated entities under this rule, supported EPA’s legal authority to consider such technologies. At the same time, the final standards do not require the manufacturers to adopt any specific technological pathway and can be achieved through the use of a variety of technologies, including without producing additional ZEVs to comply with this rule.

Section I.C summarizes our responses to certain other comments relating to our legal authority, including whether this rule implicates the major questions doctrine, whether EPA has authority for its Averaging, Banking, and Trading (ABT) program, whether EPA properly considered ZEVs as part of the class of vehicles for GHG regulation, and whether the 4-year lead time and 3-year stability requirements in CAA section 202(a)(3)(C) apply to this rule. We discuss our legal authority and rationale for battery durability and warranty separately in section III.B of the preamble. Additional discussion of legal authority for the entire rule is found in Chapters 2 and 10 of the RTC, and additional background on authority to regulate GHGs from heavy-duty motor vehicles and engines can be found in the HD GHG Phase 1 final rule.<sup>91</sup> EPA’s assessment of the statutory and other factors in selecting the final GHG standards is found in section II.G of this preamble, and further discussion of our statutory authority in support of all the revised compliance provisions is found throughout section III of this preamble.

*A. Summary of Key Clean Air Act Provisions*

Title II of the Clean Air Act provides for comprehensive regulation of emissions from mobile sources, authorizing EPA to regulate emissions of air pollutants from all mobile source categories, including motor vehicles under CAA section 202(a). To understand the scope of permissible regulation, we first must understand the scope of the regulated sources. CAA section 216(2) defines “motor vehicle”

as “any self-propelled vehicle designed for transporting persons or property on a street or highway.”<sup>92</sup> Congress has intentionally and consistently used the broad term “any self-propelled vehicle” since the Motor Vehicle Air Pollution Control Act of 1965 to include vehicles propelled by various fuels (e.g., gasoline, diesel, or hydrogen), or systems of propulsion, whether they be ICE engine, hybrid, or electric motor powertrains.<sup>93</sup> The subjects of this rulemaking all fit that definition: they are self-propelled, via a number of different powertrains, and they are designed for transporting persons or property on a street or highway. The Act’s focus is on reducing emissions from classes of motor vehicles and the “requisite technologies” that could feasibly reduce those emissions, giving appropriate consideration to cost of compliance and lead time.

Congress delegated to the Administrator the authority to identify available control technologies, and it did not place any restrictions on the types of emission reduction technologies EPA could consider, including different powertrain technologies. By contrast, other parts of the Act explicitly limit EPA’s authority by powertrain type,<sup>94</sup> so Congress’s conscious decision not to do so when defining “motor vehicle” in section 216 further highlights the breadth of EPA’s standard-setting authority for such vehicles. As we explain further below, Congress did place some limitations on

<sup>92</sup> EPA subsequently interpreted this provision through a 1974 rulemaking, 39 FR 32611 (September 10, 1974), codified at 40 CFR 85.1703. The regulatory provisions establish more detailed criteria for what qualifies as a motor vehicle, including criteria related to speed, safety, and practicality for use on streets and ways. The regulation, however, does not draw any distinctions based on whether the vehicle emits pollutants or its powertrain.

<sup>93</sup> The Motor Vehicle Air Pollution Act of 1965 defines “motor vehicle” as “any self-propelled vehicle designed for transporting persons or property on a street or highway.” Public Law 89–272, 79 Stat. 992, 995 (October 20, 1965). See also, e.g., 116 S. Cong. Rec. at 42382 (December 18, 1970) (Clean Air Act Amendments of 1970—Conference Report) (“The urgency of the problems require that the industry consider, not only the improvement of existing technology, but also alternatives to the internal combustion engine and new forms of transportation.”).

<sup>94</sup> See CAA section 213 (authorizing EPA to regulate “non-road” engines”), 216(10) (defining non-road engine to “mean[] an internal combustion engine”). Elsewhere in the Act, Congress also specified specific technological controls, further suggesting its decision to not to limit the technological controls EPA could consider in section 202(a)(1)–(2) was intentional. See, e.g., CAA section 407(d) (“Units subject to subsection (b)(1) for which an alternative emission limitation is established shall not be required to install any additional control technology beyond low NO<sub>x</sub> burners.”).

<sup>90</sup> Miller, Neil. Memorandum to docket EPA–HQ–OAR–2022–0985. Summary of Stakeholder Meetings. March 2024.

<sup>91</sup> 76 FR 57129–57130, September 15, 2011.

EPA’s standard-setting under CAA section 202(a),<sup>95</sup> but these limitations generally did not restrict EPA’s authority to broadly regulate motor vehicles to any particular vehicle type or emissions control technology.

We turn now to section 202(a)(1)–(2), which provides the statutory authority for the final GHG standards in this action. Section 202(a)(1) directs the Administrator to set “standards applicable to the emission of any air pollutant from any class or classes of new motor vehicles or new motor vehicle engines, which in his judgment cause, or contribute to, air pollution which may reasonably be anticipated to endanger public health or welfare.” This core directive has remained the same, with only minor edits, since Congress first enacted it in the Motor Vehicle Pollution Control Act of 1965.<sup>96</sup> Thus the first step when EPA regulates emissions from motor vehicles is a finding (the “endangerment finding”), either as part of the initial standard setting or prior to it, that the emission of an air pollutant from a class or classes of new motor vehicles or new motor engines causes or contributes to air pollution which may reasonably be anticipated to endanger public health or welfare.

The statute directs EPA to define the class or classes of new motor vehicles for which the Administrator is making the endangerment finding.<sup>97</sup> EPA for decades has defined “classes” subject to regulation according to their weight and function. This is consistent with both Congress’s functional definition of a “motor vehicle,” as discussed previously in this section, and Congress’s explicit contemplation of functional classes or categories. *See*

CAA section 202(b)(3)(C) (defining “heavy-duty vehicle” with reference to function and weight), 202(a)(3)(A)(ii) (“the Administrator may base such classes or categories on gross vehicle weight, horsepower, type of fuel used, or other appropriate factors.”).<sup>98</sup>

In 2009, EPA made an endangerment finding for GHG and explicitly stated that “[t]he new motor vehicles and new motor vehicle engines . . . addressed are: Passenger cars, light-duty trucks, motorcycles, buses, and medium and heavy-duty trucks.” 74 FR 66496, 66537 (December 15 2009).<sup>99</sup> Then EPA reviewed the GHG emissions data from “new motor vehicles” and determined that these classes of vehicles do contribute to air pollution that may reasonably be anticipated to endanger public health and welfare. The endangerment finding was made with regard to pollutants—in this case, GHGs—emitted from “any class or classes of new motor vehicles or new motor vehicle engines.” This approach—of identifying a class or classes of vehicles that contribute to endangerment—is how EPA has always implemented the statute.

For purposes of establishing GHG emissions standards, EPA has regarded new heavy-duty trucks (also known as heavy-duty vehicles) as its own class and has then made further sub-categorizations based on weight and functionality in promulgating standards for the air pollutant, as further elaborated in section II of this preamble.<sup>101</sup> EPA’s class and categorization framework allows the Agency to recognize real-world variations in the lead time and costs of emissions control technology for different vehicle types. It also ensures

that consumers can continue to access a wide variety of vehicles to meet their mobility needs, while enabling continued emissions reductions for all vehicle types, including to the point of completely preventing emissions where appropriate.

In setting standards, CAA section 202(a)(1) requires that any standards promulgated thereunder “shall be applicable to such vehicles and engines for their useful life (as determined under [CAA section 202(d)], relating to useful life of vehicles for purposes of certification), whether such vehicle and engines are designed as complete systems or incorporate devices to prevent or control such pollution.”<sup>102</sup> In other words, Congress specifically determined that EPA’s standards could be based on a wide array of technologies, including technologies for the engine and for the other (non-engine) parts of the vehicle, technologies that “incorporate devices” on top of an existing motor vehicle system as well as technologies that are “complete systems” and that may involve a complete redesign of the vehicle. Congress also determined that EPA could base its standards on both technologies that “prevent” the pollution from occurring in the first place—such as the zero emissions technologies considered in this rule—as well as technologies that “control” or reduce the pollution once produced.<sup>103</sup>

While emission standards set by the EPA under CAA section 202(a)(1) generally do not mandate use of particular technologies, they are technology-based, as the levels chosen must be premised on a finding of technological feasibility. EPA must therefore necessarily identify potential control technologies, evaluate the rate each technology could be introduced,

<sup>95</sup> *See, e.g.*, CAA section 202(a)(4)(A) (“no emission control device, system, or element of design shall be used in a new motor vehicle or new motor vehicle engine for purposes of complying with requirements prescribed under this subchapter if such device, system, or element of design will cause or contribute to an unreasonable risk to public health, welfare, or safety in its operation or function”). In addition, Congress established particular limitations for discrete exercises of CAA section 202(a)(1) authority which are not at issue in this rulemaking. *See, e.g.*, CAA section 202(a)(3)(A)(i) (articulating specific parameters for standards for heavy-duty vehicles applicable to emissions of certain criteria pollutants).

<sup>96</sup> Public Law 89–272.

<sup>97</sup> *See* CAA section 202(a)(1) (“The Administrator shall by regulation prescribe . . . standards applicable to the emission of any air pollutant from any class or classes of new motor vehicles or new motor vehicle engines, which in his judgment cause, or contribute to, air pollution which may reasonably be anticipated to endanger public health or welfare.” (emphasis added)), 202(a)(3)(A)(ii) (“the Administrator may base such classes or categories on gross vehicle weight, horsepower, type of fuel used, or other appropriate factors” (emphasis added)).

<sup>98</sup> Section 202(a)(3)(A)(ii) applies to standards established under section 202(a)(3), not to standards otherwise established under section 202(a)(1). However, we think it nonetheless provides guidance on what kinds of classifications and categorizations Congress generally thought were appropriate.

<sup>99</sup> EPA considered this list to be a comprehensive list of the new motor vehicle classes. *See id.* (“This contribution finding is for all of the CAA section 202(a) source categories.”); *id.* at 66544 (“the Administrator is making this finding for all classes of new motor vehicles under CAA section 202(a)”). By contrast, in making an endangerment finding for GHG emissions from aircraft, EPA limited the endangerment finding to engines used in specific classes of aircraft (such as civilian subsonic jet aircraft with maximum take off mass greater than 5,700 kilograms). 81 FR 54421, August 15, 2016.

<sup>100</sup> EPA is not reopening the 2009 or any other prior endangerment finding in this action. Rather, we are discussing the 2009 endangerment finding to provide the reader with helpful background information relating to this action.

<sup>101</sup> *See NRDC v. EPA*, 655 F.2d 318, 338 (D.C. Cir. 1981) (the Court held that “the adoption of a single particulate standard for light-duty diesel vehicles was within EPA’s regulatory discretion.”).

<sup>102</sup> *See also Engine Mfrs. Ass’n v. S. Coast Air Quality Mgmt. Dist.*, 541 U.S. 246, 252–53 (2004) (As stated by the Supreme Court, a standard is defined as that which “is established by authority, custom, or general consent, as a model or example; criterion; test . . . . This interpretation is consistent with the use of ‘standard’ throughout Title II of the CAA . . . . to denote requirements such as numerical emission levels with which vehicles or engines must comply . . . . or emission-control technology with which they must be equipped.”).

<sup>103</sup> Pollution prevention is a cornerstone of the Clean Air Act. The title of 42 U.S.C. Chapter 85 is “Air Pollution Prevention and Control”; *see also* CAA section 101(a)(3), (c). One of the very earliest vehicle pollution control technologies (one which is still in use by some vehicles) was exhaust gas recirculation, which reduces in-cylinder temperature and oxygen concentration, and, as a result, engine-out NO<sub>x</sub> emissions from the vehicles. More recent examples of pollution prevention technologies include cylinder deactivation, and electrification technologies such as idle start-stop or ZEVs.



and its cost. Standards promulgated under CAA section 202(a) are to take effect only “after such period as the Administrator finds necessary to permit the development and application of the requisite technology, giving appropriate consideration to the cost of compliance within such period.”<sup>104</sup> This reference to “cost of compliance” means that EPA must consider costs to those entities which are directly subject to the standards,<sup>105</sup> but “does not mandate consideration of costs to other entities not directly subject to the standards.”<sup>106</sup> Given the prospective nature of standard-setting and the inherent uncertainties in predicting the future development of technology, Congress entrusted to EPA the authority to assess issues of technical feasibility and availability of lead time to implement new technology. Such determinations are “subject to the restraints of reasonableness” but “EPA is not obliged to provide detailed solutions to every engineering problem posed in the perfection of [a particular device]. In the absence of theoretical objections to the technology, the agency need only identify the major steps necessary for development of the device, and give plausible reasons for its belief that the industry will be able to solve those problems in the time remaining. The EPA is not required to rebut all speculation that unspecified factors may hinder ‘real world’ emission control.”<sup>107</sup>

Although standards under CAA section 202(a)(1) are technology-based, they are not based exclusively on technological capability. Pursuant to the broad grant of authority in section 202, when setting GHG emission standards for HD vehicles, EPA must consider certain factors and may also consider other relevant factors and has done so previously when setting such standards. For instance, in HD GHG Phase 1 and Phase 2, EPA explained that when acting under this authority EPA has considered such issues as technology effectiveness, ability of the vehicle to perform its work for vehicle purchasers, its cost (including for manufacturers and for purchasers), the lead time necessary to implement the technology, and, based on this, the feasibility of potential standards; the impacts of potential standards on emissions reductions; the impacts of standards on oil conservation and energy security; the

impacts of standards on fuel savings by vehicle operators; the impacts of standards on the heavy-duty vehicle industry; as well as other relevant factors such as impacts on safety.<sup>108</sup> EPA has considered these factors in this rulemaking as well.

Rather than specifying levels of stringency in section 202(a)(1)–(2), Congress directed EPA to determine the appropriate level of stringency for the standards taking into consideration the statutory factors therein. EPA has clear authority to set standards under CAA section 202(a)(1)–(2) that are technology forcing when EPA considers that to be appropriate,<sup>109</sup> but is not required to do so. Section 202(a)(2) requires the Agency to give appropriate consideration to cost and lead time necessary to allow for the development and application of such technology. The breadth of this delegated authority is particularly clear when contrasted with section 202(b), (g), (h), which identifies specific levels of emissions reductions on specific timetables for past model years.<sup>110</sup> In determining the level of the standards, CAA section 202(a) does not specify the degree of weight to apply to each factor such that the Agency has authority to choose an appropriate balance among factors and may decide how to balance stringency and technology considerations with cost and lead time.<sup>111 112</sup>

<sup>108</sup> 81 FR 73512, October 25, 2016; 76 FR 57129–30, September 15, 2011.

<sup>109</sup> Indeed, the D.C. Circuit has repeatedly cited *NRDC v. EPA*, which construes section 202(a)(1), as support for EPA’s actions when EPA acted pursuant to other provisions of section 202 or Title II that are explicitly technology forcing. See, e.g., *NRDC v. Thomas*, 805 F. 2d 410, 431–34 (D.C. Cir. 1986) (section 202 (a)(3)(B), 202 (a)(3)(A)); *Husqvarna AB v. EPA*, 254 F. 3d 195, 201 (D.C. Cir. 2001) (section 213(a)(3)); *Nat’l Petroleum and Refiners Ass’n v. EPA*, 287 F. 3d 1130, 1136 (D.C. Cir. 2002) (section 202(a)(3)).

<sup>110</sup> See also CAA 202(a)(3)(A).

<sup>111</sup> See *Sierra Club v. EPA*, 325 F.3d 374, 378 (D.C. Cir. 2003) (even where a provision is technology-forcing, the provision “does not resolve how the Administrator should weigh all [the statutory] factors”); *Nat’l Petrochemical and Refiners Ass’n v. EPA*, 287 F.3d 1130, 1135 (D.C. Cir. 2002) (EPA decisions, under CAA provision authorizing technology-forcing standards, based on complex scientific or technical analysis are accorded particularly great deference); see also *Husqvarna AB v. EPA*, 254 F. 3d 195, 200 (D.C. Cir. 2001) (great discretion to balance statutory factors in considering level of technology-based standard, and statutory requirement “to [give appropriate] consideration to the cost of applying . . . technology” does not mandate a specific method of cost analysis); *Hercules Inc. v. EPA*, 598 F. 2d 91, 106 (D.C. Cir. 1978) (“In reviewing a numerical standard we must ask whether the agency’s numbers are within a zone of reasonableness, not whether its numbers are precisely right.”).

<sup>112</sup> Additionally, with respect to regulation of vehicular GHG emissions, EPA is not “required to treat NHTSA’s . . . regulations as establishing the baseline for the [section 202(a) standards].” *Coal*.

We now turn from section 202(a) to overview several other sections of the Act relevant to this action. CAA section 202(d) directs EPA to prescribe regulations under which the “useful life” of vehicles and engines shall be determined for the purpose of setting standards under CAA section 202(a)(1). For HD highway vehicles and engines, CAA section 202(d) establishes “useful life” minimum values of 10 years or 100,000 miles, whichever occurs first, unless EPA determines that greater values are appropriate.<sup>113</sup>

Additional sections of the Act provide authorities relating to compliance, including certification, testing, and warranty. Under section 203 of the CAA, sales of vehicles are prohibited unless the vehicle is covered by a certificate of conformity, and EPA issues certificates of conformity pursuant to section 206 of the CAA. Compliance with standards is required not only at certification but throughout a vehicle’s useful life, so that testing requirements may continue post-certification. To assure each engine and vehicle complies during its useful life, EPA may apply an adjustment factor to account for vehicle emission control deterioration or variability in use. EPA also establishes the test procedures through which compliance with the CAA emissions standards is measured. The regulatory provisions for demonstrating compliance with emissions standards have been successfully implemented for decades, including through our Averaging, Banking, and Trading (ABT) program.<sup>114</sup>

*for Responsible Regulation*, 684 F.3d at 127 (noting that the section 202(a) standards provide “benefits above and beyond those resulting from NHTSA’s fuel-economy standards”).

<sup>113</sup> In 1983, EPA adopted useful life periods to apply for HD engines criteria pollutant standards (48 FR 52170, November 16, 1983). The useful life mileage for heavy HD engines criteria pollutant standards was subsequently increased for 2004 and later model years (62 FR 54694, October 21, 1997). In the GHG Phase 2 rule (81 FR 73496, October 25, 2016), EPA set the same useful life periods to apply for HD engines and vehicles greenhouse gas emission standards, except that the spark-ignition HD engine standards and the standards for model year 2021 and later light HD engines apply over a useful life of 15 years or 150,000 miles, whichever comes first. In the Heavy Duty (HD) 2027 Low NO<sub>x</sub> final rule (HD2027 rule) (88 FR 4359, January 24, 2023), EPA lengthened useful life periods for all 2027 and later model year HD engines criteria pollutant standards. See also 40 CFR 1036.104(e), 1036.108(d), 1037.105(e), and 1037.106(e).

<sup>114</sup> EPA’s consideration of averaging in standard-setting dates back to 1985. 50 FR 1060, March 15, 1985 (“Emissions averaging, of both particulate and oxides of nitrogen emissions from heavy-duty engines, is allowed beginning with the 1991 model year. Averaging of NO, emissions from light-duty trucks is allowed beginning in 1988.”). The availability of averaging as a compliance flexibility has an even earlier pedigree. See 48 FR 33456, July

Continued

Under CAA section 207, manufacturers are required to provide emission-related warranties. The emission-related warranty period for HD engines and vehicles under CAA section 207(i) is “the period established by the Administrator by regulation (promulgated prior to November 15, 1990) for such purposes unless the Administrator subsequently modifies such regulation.” For HD vehicles, part 1037 currently specifies that the emission-related warranty for Light HD vehicles is 5 years or 50,000 miles and for Medium HD and Heavy HD vehicles is 5 years or 100,000 miles, and specifies the components covered for such vehicles.<sup>115</sup> Section 207 of the CAA also grants EPA broad authority to require manufacturers to remedy nonconformity if EPA determines there are a substantial number of noncomplying vehicles. These warranty and remedy provisions have also been applied for decades under our regulations, including where compliance occurs through use of ABT provisions. Further discussion of these sections of the Act, including as they relate to the compliance provisions we are finalizing, is found in section III of the preamble.

*B. Authority To Consider Technologies in Setting Motor Vehicle GHG Standards*

Having provided an overview of the key statutory authorities for this action, we now elaborate on the specific issue of the types of control technology that are to be considered in setting standards under section 202(a)(1)–(2). EPA’s position on this issue is consistent with our position in the HD Phase 1 and Phase 2 GHG rules, and with the historical exercise of the Agency’s section 202(a)(1)–(2) authority over the last five decades. That is, EPA’s standard-setting authority under section 202(a)(1)–(2) is not a priori limited to consideration of specific types of emissions control technology; rather, in determining the level of the standards, the agency must account for emissions control technologies that are available or will become available for the relevant

model year.<sup>116</sup> In this rulemaking, EPA has accounted for a wide range of emissions control technologies, including advanced ICE engine and vehicle technologies (e.g., engine, transmission, drivetrain, aerodynamics, tire rolling resistance improvements, the use of low carbon fuels like CNG and LNG, and H2–ICE), hybrid technologies (e.g., HEV and PHEV), and ZEV technologies (e.g., BEV and FCEV).<sup>117</sup> These include technologies applied to motor vehicles with ICE (including hybrid powertrains) and without ICE, and a range of electrification across the technologies.

In response to the proposed rulemaking, the agency received numerous comments on this issue, specifically on our consideration of BEV and FCEV technologies. Regulated entities generally offered support for the agency’s legal authority to consider such technologies, noting that they themselves were also considering varying levels of these technologies in their own product plans. Their comments relating to these technologies, and those of most stakeholders, were more technical and policy in nature, for example, relating to the pace at which manufacturers could adopt and deploy such technologies in the real world or the pace at which enabling infrastructure could be deployed. We address these comments in detail in section II of this preamble and have revised the standards from those proposed after consideration of comments.

A few commenters, however, alleged that the agency lacked statutory authority altogether to consider BEV and FCEV technologies because they believed the Act limited EPA to considering only technologies applicable to ICE vehicles or to technologies that reduce, rather than altogether prevent, pollution. EPA disagrees. The constraints they would impose have no foundation in the statutory text, are contrary to the statutory purpose, are undermined by a substantial body of statutory and legislative history, and are inconsistent

with how the agency has applied the statute in numerous rulemakings over five decades. The following discussion elaborates our position on this issue; further discussion is found in Chapter 2.1 of the RTC.

The text of the Act directly addresses this issue and provides unambiguous authority for EPA to consider all motor vehicle technologies, including a range of electrified technologies such as fully-electrified vehicle technologies without an ICE that achieve zero vehicle tailpipe emissions (e.g., BEVs), fuel cell electric vehicle technologies that run on hydrogen and achieve zero tailpipe emissions (e.g., FCEVs), plug-in hybrid partially electrified technologies, and other ICE vehicles across a range of electrification. As described earlier in this section, the Act directs EPA to prescribe emission standards for “motor vehicles,” which are defined broadly in CAA section 216(2) and do not exclude any forms of vehicle propulsion. The Act then directs EPA to promulgate emission standards for such vehicles, “whether such vehicles and engines are designed as complete systems or incorporate devices to prevent or control such pollution,” based on the “development and application of the requisite technology.” There is no question that electrified technologies, including various ICE, hybrid, BEV, and FCEV technologies, meet all of these specific statutory criteria. They apply to “motor vehicles”, are systems and incorporate devices that “prevent” and “control” emissions,<sup>118</sup> and qualify as “technology.”

<sup>118</sup> The statute emphasizes that the agency must consider emission reductions technologies regardless of “whether such vehicles and engines are designed as complete systems or incorporate devices to prevent or control such pollution.” CAA section 202(a)(1); see also CAA section 202(a)(4)(B) (describing conditions for “any device, system, or element of design” used for compliance with the standards); *Truck Trailer Manufacturers Ass’n, Inc. v. EPA*, 17 F.4th 1198, 1202 (D.C. Cir. 2021) (the statute “created two categories of complete motor vehicles. Category one: motor vehicles with built-in pollution control. Category two: motor vehicles with add-in devices for pollution control.”). While the statute does not define “system,” section 202 does use the word expansively, to include “vapor recovery system[s]” (CAA section 202(a)(5)(A)), “new power sources or propulsion systems” (CAA section 202(e)), and onboard diagnostics systems (CAA section 202(m)(1)(D)). In any event, the intentional use of the phrase “complete systems” shows that Congress expressly contemplated as methods of pollution control not only add-on devices (like catalysts that control emissions after they are produced by the engine), but wholesale redesigns of the motor vehicle and the motor vehicle engine to prevent and reduce pollution. Many technologies that reduce vehicle GHG emissions today can be characterized as systems that reduce or prevent GHG emissions, including advanced engine designs in ICE and hybrid vehicles; integration of electric drive units in hybrids, PHEVs, BEV and FCEV designs; high

21, 1983 (EPA’s first averaging program for mobile sources); 45 FR 79382, November 28, 1980 (advance notice of proposed rulemaking investigating averaging for mobile sources). We have included banking and trading in our rules dating back to 1990. 55 FR 30584, July 26, 1990 (“This final rule announces new programs for banking and trading of particulate matter and oxides of nitrogen emission credits for gasoline-, diesel- and methanol-powered heavy-duty engines.”). See section III.A of this preamble and RTC 10.2 for further background on the structure and history of our ABT program’s regulations, including consistency with CAA section 206.

<sup>115</sup> See 40 CFR 1037.120.

<sup>116</sup> For example, in 1998, EPA published regulations for the voluntary National Low Emission Vehicle (NLEV) program that allowed LD motor vehicle manufacturers to comply with tailpipe standards for cars and light-duty trucks more stringent than that required by EPA in exchange for credits for such low emission and zero emission vehicles. 63 FR 926, January 7, 1998. In 2000, EPA promulgated LD Tier 2 emission standards which built upon “the recent technology improvements resulting from the successful [NLEV] program.” 65 FR 6698, February 10, 2000.

<sup>117</sup> ZEV technologies include BEV and FCEV. Both rely on an electric powertrain to achieve zero tailpipe emissions. FCEVs run on hydrogen fuel, while BEVs are plugged in for charging.

While the statute also imposes certain specific limitations on EPA's consideration of technology, none of these statutory limitations preclude the consideration of electrified technologies, a subset of electrified technologies, or any other technologies that achieve zero vehicle tailpipe emissions. Specifically, the statute states that the following technologies cannot serve as the basis for the standards: first, technologies which cannot be developed and applied within the relevant time period, giving appropriate consideration to the cost of compliance; and second, technologies that "cause or contribute to an unreasonable risk to public health, welfare, or safety in its operation or function." CAA section 202(a)(2), (4).<sup>119</sup> The statute does not contain any other exclusions or limitations relevant to the Phase 3 model years. EPA has undertaken a comprehensive assessment of the statutory factors, further discussed in section II of the preamble and throughout the RIA and the RTC, and has found that the CAA plainly authorizes the consideration of these technologies, including BEV and FCEV technologies, at the levels that support the modeled potential compliance pathway to achieve the final standards.

Having discussed what the statutory text does say, we note what the statutory text does not say. Nothing in section 202(a)(1)–(2) distinguishes technologies that prevent vehicle tailpipe emissions from other technologies as being suitable for consideration in establishing the standards. Moreover, nothing in the statute suggests that certain kinds of electrified technologies are appropriate for consideration while other kinds of electrified technologies are not. While some commenters suggest that battery electric vehicles or fuel cell

voltage batteries and controls; redesigned climate control systems improvements, and more.

<sup>119</sup> In addition, under section 202(a)(3)(A), EPA must promulgate under section 202(a)(1) certain criteria pollutant standards for "classes or categories" of heavy-duty vehicles that "reflect the greatest degree of emission reduction achievable through the application of technology which the Administrator determines will be available . . . giving appropriate consideration to cost, energy, and safety factors associated with the application of such technology." EPA thus lacks discretion to base such standards on a technological pathway that reflects less than the greatest degree of emission reduction achievable for the class (giving consideration to cost, energy, and safety). In other words, where EPA has identified available control technologies that can completely prevent pollution and otherwise comport with the statute, the agency lacks the discretion to rely on less effective control technologies to set weaker standards that achieve fewer emissions reductions. And while section 202(a)(3)(A) does not govern any GHG standards, which are established only under section 202(a)(1)–(2), we think it is also informative as to the breadth of EPA's authority under those provisions.

vehicles represent a difference in kind from all other emissions control technologies, that is simply untrue. As we explain in section II and RIA Chapter 1, electrified technologies comprise a large range of motor vehicle technologies. In fact, *all* new motor vehicles manufactured in the United States today have some degree of electrification and rely on electrified technology to control emissions.

ICE vehicles are equipped with alternators that generate electricity and batteries that store such electricity. The electricity in turn is used for numerous purposes, such as starting the ICE and powering various vehicle electronics and accessories. More specifically, electrified technology is a vital part of controlling emissions on all new motor vehicles produced today: motor vehicles rely on electronic control modules (ECM) for controlling and monitoring their operation, including the fuel mixture (whether gasoline fuel, diesel fuel, natural gas fuel, etc.), ignition timing, transmission, and emissions control system. In enacting the Clean Air Act Amendments of 1990, Congress itself recognized the great importance of this particular electrified technology for emissions control in certain vehicles.<sup>120</sup> It would be impossible to drive any ICE vehicle produced today or to control the emissions of such a vehicle without such electrified technology.

Indeed, many of the extensive suite of technologies that manufacturers have devised for controlling emissions rely on electrified technology and do so in a host of different ways. These include technologies that improve the efficiency of the engine and system of propulsion, such as the ECMs, electronically-controlled fuel injection (for all manners of fuel, including but not limited to gasoline, diesel, natural gas, propane, and hydrogen), and automatic transmission; technologies that reduce the amount of ICE engine use such as engine stop-start technology and other idle reduction technologies; add-on technologies to control pollution after it has been generated by the engine, such as gasoline three-way catalysts, and diesel selective catalytic reduction and particulate filters that rely on electrified technology to control and monitor their performance; non-engine technologies that that rely on electrified systems to improve vehicle aerodynamics;

<sup>120</sup> See CAA 207(i)(2) (for light-duty vehicles, statutorily designating "specified major emission control components" subject to extended warranty provisions as including "an electronic emissions control unit"). Congress also designated by statute "onboard emissions diagnostic devices" as "specified major emission control components"; OBD devices also rely on electrified technology.

technologies related to vehicle electricity production, such as high efficiency alternators; and engine accessory technologies that increase the efficiency of the vehicle, such as electric coolant pumps, electric steering pumps, and electric air conditioning compressors. Because electrified technologies reduce emissions, EPA has long considered them relevant for regulatory purposes under Title II. For example, EPA has relied on various such technologies to justify the feasibility of the standards promulgated under section 202(a),<sup>121</sup> promulgated requirements and guidance related to testing involving such technologies under section 206,<sup>122</sup> required manufacturers to provide warranties for them under section 207,<sup>123</sup> and prohibited their tampering under section 203.<sup>124</sup>

Certain vehicles rely to a greater extent on electrification as an emissions control strategy. These include (1) hybrid vehicles, which rely principally on an ICE to power the wheels, but also derive propulsion from an on-board electric motor, which can charge batteries through regenerative braking, and feature a range of larger batteries than non-hybrid ICE vehicles;<sup>125</sup> (2) plug-in hybrid vehicles (PHEV), which have an even larger battery that can also be charged by plugging it into an outlet and can rely principally on electricity for propulsion, along with an ICE; (3) hydrogen fuel-cell vehicles (FCEV), which are fueled by hydrogen to produce electricity to power the wheels and have a range of larger battery sizes;<sup>126</sup> and (4) battery electric vehicles (BEV), which rely entirely on plug-in charging and the battery to provide the energy for propulsion. Manufacturers may also choose to sell different models of the same vehicle with different levels of electrification. In many but not all

<sup>121</sup> See, e.g., LD 2010 rule, 88 FR 25324, May 7, 2010; HD GHG Phase 2 rule, 81 FR 73478, October 25, 2016.

<sup>122</sup> See, e.g., HD GHG Phase 1 rule, 76 FR 57106, September 15, 2011.

<sup>123</sup> See, e.g., HD GHG Phase 1 rule, 76 FR 57106, September 15, 2011.

<sup>124</sup> See, e.g., HD GHG Phase 1 rule, 76 FR 57106, September 15, 2011.

<sup>125</sup> Hybrid vehicles include both mild hybrids, which have a relatively smaller battery and can use the electric motor to supplement the propulsion provided by the ICE, as well as strong hybrids, which have a relatively larger battery and can drive for limited distances entirely on battery power.

<sup>126</sup> As explained in section II.D.3.ii, the instantaneous power required to move a FCEV can come from either the fuel cell, the battery, or a combination of both. Interactions between the fuel cells and batteries of a FCEV can be complex and may vary based on application.

cases,<sup>127</sup> electrified technologies are systems which “prevent” (partially or completely) the emission of pollution from the motor vehicle engine.<sup>128</sup> Nothing in the statute indicates that EPA is limited from considering any of these technologies. For instance, nothing in the statute says that EPA may only consider emissions control technologies with a certain kind or level of electrification, e.g., where the battery is smaller than a certain size, where the energy derived from the battery is less than a certain percentage of total vehicle energy, where certain energy can be recharged by plugging the vehicle into an outlet as opposed to running the internal combustion engine, etc. The statute does not differentiate in terms of such details, but simply commands EPA to adopt emissions standards based on the “development and application of the requisite technology, giving appropriate consideration to the cost of compliance within such period.”

EPA’s interpretation also accords the primary purpose and operation of section 202(a), which is to reduce emissions of air pollutants from motor vehicles that are anticipated to endanger public health or welfare.<sup>129</sup> This statutory purpose compels EPA to consider available technologies that reduce emissions of air pollutants most effectively, including vehicle technologies that result in no vehicle tailpipe emissions of GHGs and completely “prevent” such emissions.<sup>130</sup> And, given Congress’s directive to reduce air pollution, it would make little sense for Congress to have authorized EPA to consider technologies that achieve 99 percent pollution reduction (for example, as some PM filter technologies do to control criteria pollutants), but not 100 percent pollution reduction. At minimum, the statute allows EPA to consider such technologies. Today, many of the available technologies that can achieve the greatest emissions control are those that rely on greater levels of electrification, with ZEV

<sup>127</sup> For example, some vehicles also use electrified technology to preheat the catalyst and improve catalyst efficiency especially when starting in cold temperatures.

<sup>128</sup> CAA section 202(a)(1).

<sup>129</sup> See also *Coal. for Responsible Regulation, Inc. v. EPA*, 684 F.3d 102, 122 (D.C. Cir. 2012), *aff’d* in part, *rev’d* in part sub nom. *Util. Air Regulation Grp. v. EPA*, 573 U.S. 302 (2014), and amended sub nom. *Coal. for Responsible Regulation, Inc. v. EPA*, 606 F. App’x 6 (D.C. Cir. 2015) (the purpose of section 202(a) is “utilizing emission standards to prevent reasonably anticipated endangerment from maturing into concrete harm”).

<sup>130</sup> CAA section 202(a)(1); see also CAA section 202(a)(4)(B) directing EPA to consider whether a technology “eliminates the emission of unregulated pollutants” in assessing its safety.

technologies capable of completely preventing vehicle tailpipe emissions.

The surrounding statutory context further highlights that Congress intended section 202 to lead to reductions to the point of complete pollution prevention. Consistent with section 202(a)(1), section 101(c), of the Act states, “A primary goal of this chapter is to encourage or otherwise promote reasonable Federal, State, and local governmental actions, consistent with the provisions of this chapter, for pollution prevention.”<sup>131</sup> Section 101(a)(3) further explains the term “air pollution prevention” (as contrasted with “air pollution control”) to mean “the reduction or elimination, through any measures, of the amount of pollutants produced or created at the source.” That is to say, EPA is not limited to requiring small reductions, but instead has authority to consider technologies that may entirely prevent the pollution from occurring in the first place. Congress also repeatedly amended the Act to itself impose extremely large reductions in motor vehicle pollution.<sup>132</sup> Similarly, Congress prescribed EPA to set standards achieving specific, numeric levels of emissions reductions (which in many instances cumulatively amount to multiple orders of magnitude),<sup>133</sup> while explicitly stating that EPA’s 202(a) authority allowed the agency to go still further.<sup>134</sup> Consistent with these statutory authorities, prior rulemakings have also required very large emissions reductions, including to the point of completely preventing certain types of emissions.<sup>135</sup>

This reading of the statute accords with the practical reality of administering an effective emissions control program, a matter in which the

<sup>131</sup> Clean Air Act Amendments, 104 Stat. 2399, 2468, November 15, 1990; see also 42 U.S.C. chapter 85 (“AIR POLLUTION PREVENTION AND CONTROL”).

<sup>132</sup> See, e.g., CAA section 202(a)(3)(A)(i) (directed EPA to promulgate standards that “reflect the greatest degree of emission reduction achievable” for certain pollutants).

<sup>133</sup> CAA section 202(a), (g)–(h), (j).

<sup>134</sup> See, e.g., CAA section 202(b)(1)(C) (“The Administrator may promulgate regulations under subsection (a)(1) revising any standard prescribed or previously revised under this subsection . . . . Any revised standard shall require a reduction of emissions from the standard that was previously applicable.”), (i)(3)(B)(iii) (“Nothing in this paragraph shall prohibit the Administrator from exercising the Administrator’s authority under subsection (a) to promulgate more stringent standards for light-duty vehicles and light-duty . . . at any other time thereafter in accordance with subsection (a).”).

<sup>135</sup> See, e.g., 31 FR 5171, March 30, 1966 (“No crankcase emissions shall be discharged into the ambient atmosphere from any new motor vehicle new motor vehicle engine subject to this subpart.”).

Agency has developed considerable expertise over the last five decades. Such a program is necessarily predicated on the continuous development of increasingly effective emissions control technologies. In determining the standards, EPA appropriately considers updated data and analysis on pollution control technologies, without *a priori* limiting its consideration to a particular set of technologies. Given the continuous development of pollution control technologies since the early days of the CAA, this approach means that EPA has routinely considered new and projected technologies developed or refined since the time of the CAA’s enactment, including for instance, electrification technologies.<sup>136</sup> The innumerable technologies on which EPA’s standards have been premised, or which EPA has otherwise incentivized, are presented in summary form later in this section and then in full in section 2 of the RTC. This approach is inherent in the statutory text of section 202(a)(2): in requiring EPA to consider lead time for the development and application of technology before standards may take effect, Congress directed EPA to consider future technological advancements and innovation rather than limiting the Agency to only those technologies in place at the time the statute was enacted. In the report accompanying the Senate bill for the 1965 legislation establishing section 202(a), the Senate Committee wrote that it “believes that exact standards need not be written legislatively but that the Secretary should adjust to changing technology.”<sup>137</sup> This forward-looking regulatory approach keeps pace with real-world technological developments that have the potential to reduce emissions and comports with congressional intent and precedent.<sup>138</sup>

<sup>136</sup> For example, when EPA issued its Tier 2 standards for light-duty and medium-duty vehicles in 2000, the Agency established “bins” of standards in addition to a fleet average requirement. 65 FR 6698, 6734–6735, February 10, 2000. One “bin” was used to certify electric vehicles that have zero criteria pollutant emissions. *Id.* Under the Tier 2 program, a manufacturer could designate which bins their different models fit into, and the weighted average across bins was required to meet the fleet average standard. *Id.* at 6746.

<sup>137</sup> S. Rep. No. 89–192, at 4 (1965). Likewise, the report accompanying the House bill stated that “the objective of achieving fully effective control of motor vehicle pollution will not be accomplished overnight. [T]he techniques now available provide only a partial reduction in motor vehicle emissions. For the future, better methods of control will clearly be needed; the committee expects that [the agency] will accelerate its efforts in this area.” H.R. Rep. No. 89–899, at 4 (1965).

<sup>138</sup> See also *NRDC*, 655 F.2d at 328 (EPA is “to project future advances in pollution control capability. It was ‘expected to press for the

For all these reasons, EPA's consideration of electrified technologies and technologies that prevent vehicle tailpipe emissions in establishing the standards is unambiguously permitted by the Act; indeed, given the Act's purpose to use technology to prevent air pollution from motor vehicles, and the agency's factual finding based on voluminous record evidence that BEV and FCEV technologies are the most effective and available technologies for doing so, the Agency's consideration of such technologies is compelled by the statute. Because the statutory text in its context is plain, we could end our interpretive inquiry here. However, we have taken the additional step of reviewing the extensive statutory and legislative history regarding the kinds of technology, including electric vehicle technology, that Congress expected EPA to consider in exercising its section 202(a) authority. Over six decades of congressional enactments and statements provide overwhelming support for EPA's consideration of electrified technologies and technologies that prevent vehicle tailpipe emissions in establishing the final standards.

As explained, section 202 does not specify or expect any particular type of motor vehicle propulsion system to remain prevalent, and it was clear to Congress as early as the 1960s that ICE vehicles might be inadequate to achieve the country's air quality goals. In 1967, the Senate Committees on Commerce and Public Works held five days of hearings on "electric vehicles and other alternatives to the internal combustion engine," which Chairman Magnuson opened by saying "The electric [car] will help alleviate air pollution and urban congestion. The consumer will benefit from instant starting, reduced maintenance, long life, and the economy of electricity as a fuel. . . . The electric car does not mean a new way of life, but rather it is a new technology to help solve the new problems of our age."<sup>139</sup> In a 1970 message to Congress seeking a stronger CAA, President Nixon stated he was initiating a program to develop "an unconventionally powered, virtually pollution free automobile" because of the possibility that "the sheer number of cars in densely populated

development and application of improved technology rather than be limited by that which exists today.;" To do otherwise would thwart congressional intent and leave EPA "unable to set pollutant levels until the necessary technology is already available.").

<sup>139</sup> *Electric Vehicles and Other Alternatives to the Internal Combustion Engine: Joint Hearings before the Comm. On Commerce and the Subcomm. On Air and Water Pollution of the Comm. On Pub. Works*, 90th Cong. (1967).

areas will begin outrunning the technological limits of our capacity to reduce pollution from the internal combustion engine."<sup>140</sup>

Since the earliest days of the CAA, Congress has also emphasized that the goal of section 202 is to address air quality hazards from motor vehicles, not to simply reduce emissions from internal combustion engines to the extent feasible. In the Senate Report accompanying the 1970 CAA Amendments, Congress made clear the EPA "is expected to press for the development and application of improved technology rather than be limited by that which exists" and identified several "unconventional" technologies that could successfully meet air quality-based emissions targets for motor vehicles.<sup>141</sup> In the 1970 amendments, Congress further demonstrated its recognition that developing new technology to ensure that pollution control keeps pace with economic development is not merely a matter of refining the ICE, but requires considering new types of motor vehicle propulsion.<sup>142</sup> Congress provided EPA with authority to fund the development of "low emission alternatives to the present internal combustion engine" as well as a program to encourage Federal purchases of "low-emission vehicles." See CAA section 104(a)(2) (previously codified as CAA section 212).<sup>143</sup> Congress also adopted section 202(e) expressly to grant the Administrator discretion under certain conditions regarding the certification of vehicles and engines based on "new power sources or propulsion system[s]," that is

<sup>140</sup> Richard Nixon, Special Message to the Congress on Environmental Quality (February 10, 1970), <https://www.presidency.ucsb.edu/documents/special-message-the-congress-environmental-quality>.

<sup>141</sup> S. Rep. No. 91-1196, at 24-27 (1970).

<sup>142</sup> In the lead up to enactment of the CAA of 1970, Senator Edmund Muskie, Chair of the Subcommittee on Environmental Pollution of the Committee on Public Works (now the Committee on Environment and Public Works), stated that "[t]he urgency of the problems required that the industry consider, not only the improvement of existing technology, but also alternatives to the internal combustion engine and new forms of transportation." 116 Cong. Rec. 42382, December 18, 1970.

<sup>143</sup> A Senate report on the Federal Low-Emission Vehicle Procurement Act of 1970, the standalone legislation that ultimately became the low-emission vehicle procurement provisions of the 1970 CAA, stated that the purpose of the bill was to direct Federal procurement to "stimulate the development, production and distribution of motor vehicle propulsion systems which emit few or no pollutants" and explained that "the best long range method of solving the vehicular air pollution problem is to substitute for present propulsion systems a new system which, during its life, produces few pollutants and performs as well or better than the present powerplant." S. Rep. No. 91-745, at 1, 4 (March 20, 1970).

to say, power sources and propulsion systems beyond the existing internal combustion engine and fuels available at the time of the statute's enactment. As the D.C. Circuit stated in 1975, "We may also note that it is the belief of many experts—both in and out of the automobile industry—that air pollution cannot be effectively checked until the industry finds a substitute for the conventional automotive power plant—the reciprocating internal combustion (*i.e.*, 'piston') engine. . . . It is clear from the legislative history that Congress expected the Clean Air Act Amendments to force the industry to broaden the scope of its research—to study new types of engines and new control systems."<sup>144</sup>

Moreover, Congress believed that the motor vehicle emissions program could achieve enormous emissions reductions, not merely modest ones, through the application and development of ever-improving emissions control technologies. For example, the Clean Air Act of 1970 required a 90 percent reduction in emissions, which was to be achieved with less lead time than this rule provides for its final standards.<sup>145</sup> Ultimately, although the industry was able to meet the standard using ICE technologies, the standard drove development of entirely new engine and emission control technologies such as exhaust gas recirculation and catalytic converters, which in turn required a switch to unleaded fuel and the development of massive new infrastructure (not present at the time the standard was finalized) to support the distribution of this fuel.<sup>146</sup>

<sup>144</sup> *Int'l Harvester Co. v. Ruckelshaus*, 478 F.2d 615, 634-35 (D.C. Cir. 1975).

<sup>145</sup> See Clean Air Act Amendments of 1970, Public Law 91-604, at sec. 6, 84 Stat. 1676, 1690, December 31, 1970 (amending section 202 of the CAA and directing EPA to issue regulations to reduce carbon monoxide and hydrocarbons from LD vehicles and engines by 90 percent in MY 1975 compared to MY 1970 and directing EPA to issue regulations to reduce NO<sub>x</sub> emissions from LD vehicles and engines by 90 percent in MY 1976 when compared with MY 1971).

<sup>146</sup> Since the new vehicle technology required on all model year 1975-76 vehicles would be poisoned by the lead in the existing gasoline, it required the rollout of an entirely new fuel to the marketplace with new refining technology needed to produce it. It was not possible for refiners to make the change that quickly to all of the nation's gasoline production, so this in turn required installation of a new parallel fuel distribution infrastructure to distribute and new retail infrastructure to dispense unleaded gasoline to the customers with MY 1975 and later vehicles while still supplying leaded gasoline to the existing fleet. In order to ensure availability of unleaded gasoline across the nation, all refueling stations with sales greater than 200,000 gallons per year were required to dispense the new unleaded gasoline. In 1974, less than 10 percent of all gasoline sold was unleaded gasoline, but by 1980 nearly 50 percent was unleaded. See generally

Continued

Since that time, Congress has continued to emphasize the importance of technology development to achieving the goals of the CAA.<sup>147</sup> In the 1990 amendments, Congress determined that evolving technologies could support further order of magnitude reductions in emissions. For example, the statutory Tier I light-duty standards required (on top of the existing standards) a further 30 percent reduction in nonmethane hydrocarbons, 60 percent reduction in NO<sub>x</sub>, and 80 percent reduction in PM for diesel vehicles. The Tier 2 light-duty standards in turn required passenger vehicles to be 77 to 95 percent cleaner.<sup>148</sup> Congress instituted a clean fuel vehicles program to promote further progress in emissions reductions, which also applied to motor vehicles as defined under section 216, see CAA section 241(1), and explicitly defined motor vehicles qualifying under the program as including vehicles running on an alternative fuel or “power source (including electricity),” CAA section 241(2).<sup>149</sup>

Congress also directed EPA to phase-in certain section 202(a) standards in CAA section 202(g)–(j).<sup>150</sup> In doing so,

Richard G. Newell and Kristian Rogers, The U.S. Experience with the Phasedown of Lead in Gasoline, Resources for the Future (June 2003), available at <https://web.mit.edu/ckolstad/www/Newell.pdf>.

<sup>147</sup> For example, in the lead up to the CAA Amendments of 1990, the House Committee on Energy and Commerce reported that “[t]he Committee wants to encourage a broad range of vehicles using electricity, improved gasoline, natural gas, alcohols, clean diesel fuel, propane, and other fuels.” H. Rep. No. 101–490, at 283 (May 17, 1990).

<sup>148</sup> See 65 FR 28, February 10, 2000.

<sup>149</sup> See also CAA section 246(f)(4) (under the clean fuels program, directing the Administrator to issue standards “for Ultra-Low Emission Vehicles (ULEV’s) and Zero Emissions Vehicles (ZEV’s)” and to conform certain such standards “as closely as possible to standards which are established by the State of California for ULEV and ZEV vehicles in the same class.”).

<sup>150</sup> CAA section 202(g) required a phase in for LD trucks up to 6,000 lbs GVWR and LD vehicles beginning with MY 1994 for emissions of nonmethane hydrocarbons (NMHC), carbon monoxide (CO), nitrogen oxides (NO<sub>x</sub>), and particulate matter (PM). These standards phased in over several years. Similarly, CAA section 202(h) required standards to be phased in beginning with MY 1995 for LD trucks of more than 6,000 lbs GVWR for the same pollutants. CAA section 202(i) required EPA to study whether further emission reductions should be required with respect to MYs after January 1, 2003 for certain vehicles. CAA section 202(j) required EPA to promulgate regulations applicable to CO emissions from LD vehicles and LD trucks when operated under “cold start” conditions *i.e.*, when the vehicle is operated at 20 degrees Fahrenheit. Congress directed EPA to phase in these regulations beginning with MY 1994 under Phase I, and to study the need for further reductions of CO and the maximum reductions achievable for MY 2001 and later LD vehicles and LD trucks when operated in cold start conditions. In addition, Congress specified that any “revision

Congress recognized that certain technologies, while extremely potent at achieving lower emissions, would be difficult for the entire industry to adopt all at once. Rather, it would be more appropriate for the industry to gradually implement the standards over a longer period of time. This is directly analogous to EPA’s assessment in this final rule, which finds that industry will gradually shift to more effective emissions control technologies over a period of time. Generally speaking, phase-ins, fleet averages, and ABT all are means of addressing the question, recognized by Congress in section 202, of how to achieve emissions reductions to protect public health when it may be difficult (or less preferable for manufacturers) to implement a stringency increase across the entire fleet simultaneously.

Similar to EPA’s ABT program, these statutory phase-in provisions also evaluated compliance with respect to a manufacturer’s fleet of vehicles over the model year. More specifically, CAA section 202(g)–(j) each required a specified percentage of a manufacturer’s fleet to meet a specified standard for each model year (*e.g.*, 40 percent of a manufacturer’s sales volume must meet certain standards by MY 1994). This made the level of a manufacturer’s production over a model year a core element of the standard. In other words, the form of the standard mandated by Congress in these sections recognized that pre-production certification would be based on a projection of production for the upcoming model year, with actual compliance with the required percentages not demonstrated until after the end of the model year. Compliance was evaluated not only with respect to individual vehicles, but with respect to the fleet as a whole. EPA’s ABT provisions use this same approach, adopting a similar, flexible form, that also makes the level of a manufacturer’s production a core element of the standard and evaluates compliance at the fleet level, in addition to at the individual vehicle level.

In enacting the Energy Independence and Security Act of 2007, Congress also recognized the possibility that fleet-average standards also recognized the possibility of fleet-average standards. The statute barred Federal agencies from acquiring “a light duty motor vehicle or medium duty passenger vehicle that is not a low greenhouse gas emitting vehicle.”<sup>151</sup> It directed the Administrator to promulgate guidance

under this subchapter may provide for a phase-in of the standard.” CAA 202(b)(1)(C).

<sup>151</sup> 42 U.S.C. 13212(f)(2)(A).

on such “low greenhouse gas emitting vehicles,” but explicitly prohibited vehicles from so qualifying “if the vehicle emits greenhouse gases at a higher rate than such standards allow for the *manufacturer’s fleet average grams per mile of carbon dioxide-equivalent emissions for that class of vehicle*, taking into account any emissions allowances and adjustment factors such standards provide.”<sup>152</sup> Congress thus explicitly contemplated the possibility of motor vehicle GHG standards with a fleet average form.<sup>153</sup>

The recently-enacted IRA<sup>154</sup> demonstrates Congress’s continued resolve to drive down emissions from motor vehicles through the application of the entire range of available technologies, and specifically highlights the importance of ZEV technologies. The IRA “reinforces the longstanding authority and responsibility of [EPA] to regulate GHGs as air pollutants under the Clean Air Act,”<sup>155</sup> and “the IRA clearly and deliberately instructs EPA to use” this authority by “combin[ing] economic incentives to reduce climate pollution with regulatory drivers to spur greater reductions under EPA’s CAA authorities.”<sup>156</sup> To assist with this, as described in section II and RIA Chapter 1, the IRA provides a number of economic incentives for HD ZEVs and the infrastructure necessary to support them, and specifically affirms Congress’s previously articulated statements that non-ICE technologies

<sup>152</sup> 42 U.S.C. 13212(f)(3)(C) (emphasis added).

<sup>153</sup> 42 U.S.C. 13212 does not specifically refer back to CAA section 202(a). However, we think it is plain that Congress intended for EPA in implementing section 13212 to consider relevant CAA section 202(a) standards as well as standards issued by the State of California. See 42 U.S.C. 13212(f)(3)(B) (“In identifying vehicles under subparagraph (A), the Administrator shall take into account the most stringent standards for vehicle greenhouse gas emissions applicable to and enforceable against motor vehicle manufacturers for vehicles sold anywhere in the United States.”). As explained in the text, EPA has historically set fleet average standards under CAA section 202(a) for certain emissions from motor vehicles. Under section 209(b) of the Clean Air Act, EPA may also authorize the State of California to adopt and enforce its own motor vehicle emissions standards subject the statutory criteria. California has also adopted certain fleet average motor vehicle emissions standards. No other Federal agency or State government has authority to establish emissions standards for new motor vehicles, although certain States may choose to adopt standards identical to California’s pursuant to CAA section 177.

<sup>154</sup> Inflation Reduction Act, Public Law 117–169, 136 Stat. 1818, (2022), available at <https://www.congress.gov/117/bills/hr5376/BILLS-117hr5376enr.pdf>.

<sup>155</sup> 168 Cong. Rec. E868–02 (daily ed. August 12, 2022) (statement of Rep. Pallone, Chairman of the House Energy and Commerce Committee).

<sup>156</sup> 168 Cong. Rec. E879–02, at 880 (daily ed. August 26, 2022) (statement of Rep. Pallone).

will be a key component of achieving emissions reductions from the mobile source sector, including the HD sector.<sup>157</sup> The legislative history reflects that “Congress recognizes EPA’s longstanding authority under CAA section 202 to adopt standards that rely on zero emission technologies, and Congress expects that future EPA regulations will increasingly rely on and incentivize zero-emission vehicles as appropriate.”<sup>158</sup> These developments further confirm that the focus of CAA section 202 is on application of innovative technologies to reduce vehicular emissions, and not on the means by which vehicles are powered. This statutory and legislative history, beginning with the 1960s and through the recently enacted IRA, demonstrate Congress’s historical and contemporary commitment to reducing motor vehicle emissions through the application of increasingly advanced technologies. Consistent with Congress’s intent and this legislative history, EPA’s rulemakings have taken the same approach, basing standards on ever-evolving technologies that have allowed for enormous emissions reductions. As required by the Act, EPA has consistently considered the lead time and costs of control technologies in determining whether and how they should be included in the technological packages for the standards, along with other factors that affect the real-world adoption or impacts of the technologies as appropriate. Over time, EPA’s motor vehicle emission standards have been based on and stimulated the development of a broad set of advanced technologies—such as electronic fuel injection systems, gasoline catalytic converters, diesel particulate filters, diesel NO<sub>x</sub> reduction catalysts, gasoline direct injection fuel systems, and advanced transmission technologies—which have been the building blocks of heavy-duty vehicle designs and have yielded not only lower pollutant emissions, but improved vehicle performance, reliability, and durability. Many of these technologies did not exist when Congress first granted EPA’s section 202(a) authority in 1965, but these technologies nonetheless have been successfully adopted and reduced emissions by multiple orders of magnitude.

<sup>157</sup> See Inflation Reduction Act, Public Law 117–169, at §§ 13204, 13403, 13404, 13501, 13502, 50142–50145, 50151–50153, 60101–60104, 70002 136 Stat. 1818, (2022), available at <https://www.congress.gov/117/bills/hr/5376/BILLS-117hr5376enr.pdf>.

<sup>158</sup> 168 Cong. Rec. E879–02, at 880 (daily ed. August 26, 2022) (statement of Rep. Pallone).

As previously discussed, beginning in 2011, EPA has set HD vehicle and engine standards under section 202(a)(1)–(2) for GHGs.<sup>159</sup> Manufacturers have responded to these standards over the past decade by continuing to develop and deploy a wide range of technologies, including more efficient engine designs, transmissions, aerodynamics, tires, and air conditioning systems that contribute to lower GHG emissions, as well as vehicles based on methods of propulsion beyond diesel- and gasoline-fueled ICE vehicles, including ICE running on alternative fuels, as well as various levels of electrified vehicle technologies from mild hybrids, to strong hybrids, and up through battery electric vehicles and fuel-cell vehicles.

EPA has long established performance-based emission standards that anticipate the use of new and emerging technologies.<sup>160</sup> In both the HD Phase 1<sup>161</sup> and Phase 2 standards,<sup>162</sup> as in this rule, EPA specifically considered the availability of electrified technologies, including ZEV technologies. At the time of the HD Phase 1 and 2 rules, EPA determined based on the record before it that certain technologies, namely more electrified technologies like PHEV and BEV as well as FCEV, should not be part of the technology packages to support the feasibility of the standards given that they were not expected to be sufficiently available during the model years for those rules, giving consideration to lead time and costs of compliance. Instead, recognizing the possible future use of those technologies and their potential to achieve very large emissions reductions, EPA incentivized their development and deployment through advanced technology credit multipliers, which give manufacturers additional ABT

<sup>159</sup> 76 FR 57106, September 15, 2011 (establishing first ever GHG standards for heavy-duty vehicles).

<sup>160</sup> For example, in EPA’s 2016 HD Phase 2 regulations, the Agency explained that the emission standards were “predicated on use of both off-the-shelf technologies and emerging technologies that are not yet in widespread use” and which we projected would “require manufacturers to make extensive use of these technologies.” 81 FR 73478, October 25, 2016. See also, e.g., *NRDC v. Thomas*, 805 F. 2d 410, 431 (D.C. Cir. 1986) (upholding EPA rule where EPA identified trap oxidizers technology as the basis for compliance with numerical PM standard); *Nat’l Petroleum and Refiners Ass’n v. EPA*, 287 F. 3d 1130, 1136 (D.C. Cir. 2002) (NO<sub>x</sub> absorbers and catalyzed particulate filters as basis for complying with numerical NOs and PM standards.).

<sup>161</sup> The Phase 1 GHG program set standards for MY 2014 through 2018 and later. See 76 FR 57106 (September 15, 2011).

<sup>162</sup> The Phase 2 GHG program set standards for MY 2021 through 2027 and later for combination tractors, vocational vehicles, HD pickup trucks and vans, and engines.

credits for producing such vehicles. In this rule, EPA continues to consider these technologies, and based on the updated record, finds that such technologies will be available at a reasonable cost during the timeframe for this rule, and therefore has included them in the technology packages to support the level of the standards under the modeled potential compliance pathway.

The analysis of the statutory text, purpose and history, as well as EPA’s history of implementing the statute, demonstrate that the agency must, or at a minimum may, appropriately consider available electrified technologies that completely prevent emissions in determining the final standards. In this rulemaking, EPA has done so. The agency has made the necessary predictive judgments as to potential technological developments that can support the feasibility of the final standards and also as to the availability of supporting charging and refueling infrastructure and critical minerals necessary to support those technological developments, as applicable. In making these judgments, EPA has adhered to the long-standing approach established by the D.C. Circuit, identifying a reasonable sequence of future developments, noting potential difficulties, and explaining how they may be obviated within the lead time afforded for compliance. EPA has also consulted with other organizations with relevant expertise such as the Departments of Energy and Transportation, including through careful consideration of their reports and related analytic work reflected in the administrative record for this rulemaking.

Although the standards are supported by the Administrator’s predictive judgments regarding pollution control technologies and the modeled potential compliance pathway, we emphasize that the final standards are not a mandate for a specific type of technology. They do not legally or de facto require a manufacturer to follow a specific technological pathway to comply. Consistent with our historical practice, EPA is finalizing performance-based standards that provide compliance flexibility to manufacturers. While EPA projects that manufacturers may comply with the standards through the use of certain technologies, including a mix of advanced ICE vehicles, BEVs, and FCEVs, manufacturers may select any technology or mix of technologies that would enable them to meet the final standards.

These choices are real and valuable to manufacturers, as attested to by the

historical record. The real-world results of our prior rulemakings make clear that industry sometimes chooses to comply with our standards in ways that the Agency did not anticipate, presumably because it is more cost-effective for them to do so. In other words, while EPA sets standards that are feasible based on our modeling of potential compliance pathways, manufacturers may find what they consider to be better pathways to meet the standards and may opt to follow those pathways instead.

For example, in promulgating the 2010 LD GHG rule, EPA modeled a technology pathway for compliance with the MY 2016 standards. In actuality, manufacturers diverged from EPA's projections across a wide range of technologies, instead choosing their own technology pathways best suited for their fleets.<sup>163</sup> <sup>164</sup> For example, EPA projected greater penetration of dual-clutch transmissions than ultimately occurred in the MY 2016 fleet; by contrast, use of 6-speed automatic transmissions was twice what EPA had predicted. Both transmission technologies represented substantial improvements over the existing transmission technologies, with the manufacturers choosing which specific technology was best suited for their products and customers. Looking specifically at electrification technologies, start-stop systems were projected at 45 percent and were used in 10 percent of vehicles, while strong hybrids were projected to be 6.5 percent of the MY 2016 fleet and were actually only 2 percent.<sup>165</sup> Notwithstanding

<sup>163</sup> See EPA Memorandum to the docket for this rulemaking, "Comparison of EPA CO<sub>2</sub> Reducing Technology Projections between 2010 Light-duty Vehicle Rulemaking and Actual Technology Production for Model Year 2016".

<sup>164</sup> Similarly, in our 2001 final rule promulgating heavy-duty nitrogen oxide (NO<sub>x</sub>) and particulate matter (PM) standards, for example, we predicted that manufacturers would comply with the new nitrogen oxide (NO<sub>x</sub>) standards through the addition of NO<sub>x</sub> absorbers or "traps." 66 FR 5002, 5036 (January 18, 2001) ("[T]he new NO<sub>x</sub> standard is projected to require the addition of a highly efficient NO<sub>x</sub> emission control system to diesel engines."). We stated that we were not basing the feasibility of the standards on selective catalytic reduction (SCR) noting that SCR "was first developed for stationary applications and is currently being refined for the transient operation found in mobile applications." *Id.* at 5053. However, industry's approach to complying with the 2001 standards ultimately included the use of SCR for diesel engines. We also projected that manufacturers would comply with the final PM standards through the addition of PM traps to diesel engines; however, industry was able to meet the PM standards without the use of PM traps or any other PM aftertreatment systems.

<sup>165</sup> Although in 2010, EPA overestimated technology penetrations for strong hybrids, in 2012, we underestimated technology penetrations for PEVs, projecting on 1 percent penetration by MY

these differences between EPA's projections and actual manufacturer decisions, the industry as a whole was not only able to comply with the standards during the period of those standards (2012–2016), but to generate substantial additional credits for overcompliance.<sup>166</sup>

In support of the final standards, EPA has also performed additional modeling demonstrating that the standards can be met in multiple ways. As discussed in section II.F.4 of the final rule preamble, while our modeled potential compliance pathway includes a mix of ICE vehicles, BEV, and FCEV technologies, we also evaluated additional examples of potential technology packages and potential compliance pathways that include only additional vehicles with ICE across a range of electrification. These additional examples of technology pathways also support the feasibility of the final standards and show that the final standards may be met without producing additional ZEVs to comply with this rule.<sup>167</sup>

### C. Response to Other Comments Raising Legal Issues

In this section, EPA summarizes our responses to certain other comments relating to our legal authority. These include three comments relating to our legal authority to consider certain technologies discussed in section I.B: whether this rule implicates the major questions doctrine, whether EPA has authority for its Averaging, Banking, and Trading (ABT) program, and whether EPA erred in considering heavy-duty ZEVs as part of the same

2021, while actual sales exceeded 4 percent. Compare 2012 Rule RIA, Table 3.5–22 with 2022 Automotive Trends Report, Table 4.1.

<sup>166</sup> See 2022 Automotive Trends Report, Fig. ES–8 (industry generated credits each year from 2012–2015 and generated net credits for the years 2012–2016).

<sup>167</sup> We stress, however, that these additional pathways are not necessary to justify this rulemaking; the statute requires EPA to demonstrate that the standards can be met by the development and application of technology, but it does not require the agency to identify multiple technological solutions to the pollution control problem before mandating more stringent standards. That EPA has done so in this rulemaking, identifying a wide array of technologies capable of further reducing emissions, only highlights the feasibility of the standards and the significant practical flexibilities manufacturers have to attain compliance. We observe that some past standards have been premised on the application of a single known technology at the time, such as the catalytic converter. See *Int'l Harvester v. Ruckelshaus*, 478 F.2d 615, 625 (D.C. Cir. 1973) (in setting standards for light duty vehicles, the Court upheld EPA's reliance on a single kind of technology); see also 36 FR 12657 (1971) (promulgating regulations for light duty vehicles based on the catalytic converter).

class as other heavy-duty vehicles for GHG regulation. These comments were raised only by entities not regulated by this rule. This section also addresses a comment regarding whether the 4-year lead time and 3-year stability requirements in CAA section 202(a)(3)(C) apply to this rule. We separately discuss our legal authority and rationale for battery durability and warranty in section III.B of the preamble.

*Major questions doctrine.* While many commenters recognized EPA's legal authority to adopt the final GHG standards, certain commenters claimed that this rule asserts a novel and transformative exercise of regulatory power that implicates the major questions doctrine and exceeds EPA's legal authority. These arguments were intertwined with arguments challenging EPA's consideration of electrified technologies. Some commenters claimed that the agency's decision to do so and the resulting GHG standards would mandate a large increase in electric vehicles. According to these commenters, this in turn would cause indirect impacts, including relating to issues allegedly outside EPA's traditional areas of expertise, such as to the petroleum refining industry, electricity transmission and distribution infrastructure, grid reliability, and US national security.

EPA does not agree that this rule implicates the major questions doctrine as that doctrine has been elucidated by the Supreme Court in *West Virginia v. EPA* and related cases.<sup>168</sup> The Court has made clear that the doctrine is reserved for extraordinary cases involving assertions of highly consequential power beyond what Congress could reasonably be understood to have granted. This is not such an extraordinary case in which congressional intent is unclear. Here, EPA is acting within the heartland of its statutory authority and faithfully implementing Congress's precise direction and intent.

First, as we explain in section I.A–B of the preamble, the statute provides clear congressional authorization for EPA to consider updated data on pollution control technologies—including BEV and FCEV technologies—and to determine the emission standards accordingly. In section 202(a), Congress made the major policy decision to regulate air pollution from motor vehicles. Congress also prescribed that EPA should accomplish this mandate through a technology-based approach,

<sup>168</sup> *W. Virginia v. EPA*, 142 S. Ct. 2587, 2605, 2610 (2022).



and it plainly entrusted to the Administrator's judgment the evaluation of pollution control technologies that are or will become available given the available lead-time and the consequent determination of the emission standards. In the final rule, the Administrator determined that a wide variety of technologies exist to further control GHGs from HD vehicles—including various ICE, hybrid, and ZEV technologies such as BEVs and FCEVs—and that such technologies could be applied at a reasonable cost to achieve significant reductions of GHG emissions that contribute to the ongoing climate crisis. These subsidiary technical and policy judgments were clearly within the Administrator's delegated authority.

Second, the agency is not invoking a novel authority. As described previously in this section, EPA has been regulating emissions from motor vehicles based upon the availability of feasible technologies to reduce vehicle emissions for over five decades. EPA has specifically regulated GHG emissions from heavy-duty vehicles since 2011. Our rules, including this rule and the HD Phase 1 and HD Phase 2 rules, have consistently considered available technology to reduce or prevent emissions of the relevant pollutant, including technologies to reduce or completely prevent GHGs. Our consideration of ZEV technologies specifically has a long pedigree, beginning with the 1998 National Low Emission Vehicle (NLEV) program. Further, the administrative record here indicates the industry will likely choose to deploy an increasing number of vehicles with emissions control technologies such as BEV and FCEV, in light of new technological advances, the IRA and other government programs, as well as this rule. That the industry will continue to apply the latest technologies to reduce pollution is no different than how the industry has responded to EPA's rules for half a century. The agency's factual findings and resulting determination of the degree of stringency do not represent the exercise of a newfound power. Iterative increases to the stringency of an existing program based on new factual developments hardly reflect an unprecedented expansion of agency authority.

Not only does this rule not invoke any new authority, it also falls well within EPA's traditionally delegated powers. Through five decades of regulating vehicle emissions under the CAA, EPA has developed great expertise in the regulation of motor vehicle emissions, including specifically GHG emissions (see RIA Chapter 2.1). The agency's expertise is reflected in the

comprehensive analyses present in the administrative record. The courts have recognized the agency's authority in this area.<sup>169</sup> The agency's analysis includes our assessment of available pollution control technologies; the design and application of a quantitative model (HD TRUCS) for assessing feasible rates of technology adoption; the economic costs of developing, applying, and using pollution control technologies; the context for deploying such technologies (e.g., the supply of raw materials and components, and the availability of supporting charging and refueling infrastructure); the impacts of using pollution control technologies on emissions, and consequent impacts on public health, welfare, and the economy. While each rule necessarily deals with different facts, such as advances in new pollution control technologies at the time of that rule, the above factors are among the kinds of considerations that EPA regularly evaluates in its motor vehicle rules, including all our prior GHG rules.

Third, this rule does not involve decisions of vast economic and political importance exceeding EPA's delegated authority. To begin with, commenters err in characterizing this rule as an "EV mandate." That is false as a legal matter and a practical matter. As a legal matter, this rule does not mandate that any manufacturer use any specific technology to meet the standards in this rule. And as a practical matter, as explained in section II.F.3 of the preamble and Chapter 1.4 of the RIA, manufacturers can adopt a wide array of technologies, including various ICE, hybrid, electric, and fuel-cell technologies, to comply with this rule. Specifically, EPA has identified several additional potential compliance pathways, including pathways without producing additional ZEVs to comply with this rule, that can be achieved in the lead-time provided and at a reasonable cost. Moreover, the adoption of additional control technologies, including ZEVs, are complementary to what the manufacturers are already doing regardless of this rule. As major HD vehicle manufacturers told EPA in their comments, they have already made considerable investments and shifted future product plans to focus on ZEV technologies, including in response to the significant incentives for ZEVs that Congress provided in the IRA, and they support EPA establishing the standards

<sup>169</sup> See, e.g., *Massachusetts v. EPA*, 549 U.S. 497, 532 (2007) ("Because greenhouse gases fit well within the Clean Air Act's capacious definition of 'air pollutant,' we hold that EPA has the statutory authority to regulate the emission of such gases from new motor vehicles.").

based on the increasing availability of ZEV technologies. Looking to the future under the No Action scenario, as shown in RIA Table 4–8, we project that by 2032 ZEVs will account for between 4.7 percent (long-haul tractors) and 30.1 percent (LHD vocational) of new HD vehicles, depending on regulatory group. The final rule builds on these industry trends. It will likely cause some heavy-duty manufacturers to adopt control technologies more rapidly than they otherwise would, and this will result in significant pollution reductions and large public health and welfare benefits. However, that is the entire point of section 202(a); that EPA and the regulated industry may be successful in achieving Congress's purposes does not mean the agency has exceeded its delegated authority.

The regulatory burdens of this rule are also reasonable and not different in kind from prior exercises of EPA's authority under section 202. The regulated community of heavy-duty vehicle manufacturers in this rule was also regulated by the earlier Phase 1 and Phase 2 rules. In terms of costs of compliance for regulated entities, EPA anticipates that the rule will result in aggregate cost savings for manufacturers, both in light of technological advances in ZEV technologies and the significant incentives provided by the IRA. When we assess the fleet average costs of compliance per HD vehicle during the year in which the program is fully phased-in, we also find relatively lower costs compared to Phase 2.<sup>170</sup> These costs, moreover, are a small fraction of the costs of new HD vehicles and small relative to what Congress itself accepted in enacting section 202.<sup>171</sup> The rule also does not create any other excessive regulatory burdens on regulated entities; for example, the rule does not require any manufacturer to shut down, or to curtail or delay production.

While section 202 does not require EPA to consider consumer costs, the agency recognizes that such costs, and consumer acceptance of new pollution control technologies more broadly, can affect the application of such technologies. As such, EPA carefully evaluated these issues. For purchasers of HD vehicles, we project a range of

<sup>170</sup> We further discuss costs in preamble sections IV and II.G, and we provide numerical comparisons of costs to the Phase 1 and 2 rules in section 2 of the RTC.

<sup>171</sup> See *Motor & Equip. Mfrs. Ass'n, Inc. v. EPA*, 627 F.2d 1095, 1118 (DC Cir. 1979) ("Congress wanted to avoid undue economic disruption in the automotive manufacturing industry and also sought to avoid doubling or tripling the cost of motor vehicles to purchasers.").

upfront costs, including savings for certain vehicle types. For all vehicle types, we expect that the final standards will be economically beneficial for purchasers because the lower operating costs during the operational life of the vehicle will offset the increase in upfront vehicle technology costs within the usual period of first ownership of the vehicle. Furthermore, purchasers will benefit from annual operating cost savings for each year after the payback occurs. EPA also carefully designed the final rule to avoid any other kinds of disruptions to purchasers. For example, we recognize that HD vehicles represent a diverse array of vehicles and use cases, and we carefully tailored the standards for each regulatory subcategory to ensure that purchasers could obtain the kinds of HD vehicles they need. We also recognized that HD vehicles require supporting infrastructure (e.g., fueling and charging stations) to operate, and we accounted for sufficient lead-time for the development of that infrastructure, including private depot charging, public charging, and hydrogen refueling infrastructure. We also identified numerous industry standards and safety protocols to ensure the safety of HD vehicles, including BEVs and FCEVs.

We acknowledge the rule may have other impacts beyond those on regulated entities and their customers (for purposes of discussion here, referred to as “indirect impacts”). But indirect impacts are inherent in section 202 rulemakings, including past rulemakings going back half a century. As the DC Circuit has observed, in the specific context of EPA’s Clean Air Act Title II authority to regulate motor vehicles, “[e]very effort at pollution control exacts social costs. Congress . . . made the decision to accept those costs.”<sup>172</sup> In EPA’s long experience of promulgating environmental regulations, the presence of indirect impacts does not reflect the extraordinary nature of agency action, but rather the ordinary state of the highly interconnected and global supply chain for motor vehicles. In any event, EPA has considerable expertise in

<sup>172</sup> *Motor & Equip. Mfrs. Ass’n, Inc. v. EPA*, 627 F.2d 1095, 1118 (DC Cir. 1979); see also *id.* (“There is no indication that Congress intended section 202’s cost of compliance consideration to embody social costs of the type petitioners advance,” and holding that the statute does not require EPA to consider antitrust concerns); *Coal. for Responsible Regul. Inc. v. EPA*, 684 F.3d 102, 128 (DC Cir. 2012) (holding that the statute “does not mandate consideration of costs to other entities not directly subject to the proposed standards”); *Massachusetts v. EPA*, 549 U.S. 497, 534 (2007) (impacts on “foreign affairs” are not sufficient reason for EPA to decline making the endangerment finding under section 202(a)(1)).

evaluating the broader social impacts of the agency’s regulations, for example on public health and welfare, safety, energy, employment, and national security. Congress has recognized the agency’s expertise in many of these areas,<sup>173</sup> and EPA has regularly considered such indirect impacts in our prior rules.

EPA carefully analyzed indirect impacts and coordinated with numerous Federal and other partners with relevant expertise, as described in sections ES.E and II of the preamble.<sup>174</sup> The consideration of many indirect impacts is included in our assessment of the rule’s costs and benefits. We estimate annualized net benefits of \$13 billion through the year 2055 when assessed at a 2 percent discount rate (2022\$). This number is actually smaller than the net benefits of the Phase 2 rule; it is also a small fraction when compared to the size of the heavy-duty industry itself, which is rapidly expanding.<sup>175</sup> and a

<sup>173</sup> See, e.g., CAA section 202(a)(1) (requiring EPA Administrator to promulgate standards for emissions from motor vehicles “which in his judgment cause, or contribute to, air pollution which may reasonably be anticipated to endanger public health or welfare”), 202(a)(3)(A) (requiring the agency to promulgate certain motor vehicle emission standards “giving appropriate consideration to cost, energy, and safety factors associated with the application of such technology”), 203(b)(1) (authorizing the Administrator to “exempt any new motor vehicle or new motor vehicle engine” from certain statutory requirements “upon such terms and conditions as he may find necessary . . . for reasons of national security”), 312(a) (directing EPA to conduct a “comprehensive analysis of the impact of this chapter on the public health, economy, and environment of the United States”).

<sup>174</sup> For example, we consulted with the following Federal agencies and workgroups on their relevant areas of expertise: National Highway Traffic Safety Administration (NHTSA) at the Department of Transportation (DOT), Department of Energy (DOE) including several national laboratories (Argonne National Laboratory (ANL), National Renewable Energy Laboratory (NREL), and Oak Ridge National Laboratory (ORNL)), United States Geological Survey (USGS) at the Department of Interior (DOI), Joint Office of Energy and Transportation (JOET), Federal Energy Regulatory Commission (FERC), Department of Commerce (DOC), Department of Defense (DOD), Department of State, Federal Consortium for Advanced Batteries (FCAB), and Office of Management and Budget (OMB). We also consulted with State and regional agencies, and we engaged extensively with a diverse set of stakeholders, including vehicle manufacturers, labor unions, technology suppliers, dealers, utilities, charging providers, environmental justice organizations, environmental organizations, public health experts, tribal governments, and other organizations.

<sup>175</sup> See Precedence Research, Heavy Duty Trucks Market, <https://www.precedenceresearch.com/heavy-duty-trucks-market> (“The U.S. heavy duty trucks market size was valued at USD 52.23 billion in 2023 and is expected to reach USD 105.29 billion by 2032, growing at a CAGR of 8.10% from 2023 to 2032.”).

tiny fraction of the size of the US economy.<sup>176</sup>

EPA also carefully evaluated many indirect impacts outside of the net benefits assessment, and we identified no significant indirect harms and the potential for indirect benefits. Based on our analysis, EPA projects that this rulemaking will not cause significant adverse impacts on electric grid reliability or resource adequacy, that there will be sufficient battery production and critical minerals available to support increasing ZEV production including due to large anticipated increases in domestic battery and critical mineral production, that there will be sufficient lead-time to develop charging and hydrogen refueling infrastructure, and that the rule will have significant positive national security benefits. We also identified significant initiatives by the Federal government (such as the BIL and IRA), State and local government, and private firms, that complement EPA’s final rule, including initiatives to reduce the costs to purchase ZEVs; support the development of domestic critical mineral, battery, and ZEV production; improve the electric grid; and accelerate the establishment of charging and hydrogen refueling infrastructure.

These and other kinds of indirect impacts, moreover, are similar in kind to the impacts of past EPA motor vehicle rules. For example, this rule may reduce the demand for gasoline and diesel for HD vehicles domestically and affect the petroleum refining industry, but that has been the case for all of EPA’s past GHG vehicle rules, which also reduced demand for liquid fuels through advances in ICE engine and vehicle technologies and corresponding fuel efficiency. And while production of ZEVs does rely on a global supply chain, that is true for all motor vehicles, which rely extensively on imports, from raw materials like aluminum to components like semiconductors; addressing supply chain vulnerabilities is a key component of managing any significant manufacturing operation in today’s global world. Further, while ZEVs may require supporting infrastructure to operate, the same is true for ICE vehicles; indeed, supporting infrastructure for ICE vehicles has changed considerably over time in response to environmental regulation,

<sup>176</sup> US GDP reached \$25.46 trillion dollars in 2022. See Bureau of Economic Analysis, *Gross Domestic Product, Fourth Quarter and Year 2022 (Second Estimate)* (February 23, 2023), available at <https://www.bea.gov/news/2023/gross-domestic-product-fourth-quarter-and-year-2022-third-estimate-gdp-industry-and>.

for example, with the elimination of lead from gasoline, the provisioning of diesel exhaust fluid (DEF) at truck stops to support selective catalytic reduction (SCR) technologies, and the introduction of low sulfur diesel fuel to support diesel particulate filter (DPF) technologies.

As with prior GHG vehicle rules, many indirect impacts are positive:<sup>177</sup> foremost, the significant benefits of mitigating climate change, which poses catastrophic risks for human health and the environment, water supply and quality, storm surge and flooding, electricity infrastructure, agricultural disruptions and crop failures, human rights, international trade, and national security. Other positive indirect impacts include reduced dependence on foreign oil and increased energy security and independence; increased regulatory certainty for domestic production of pollution control technologies and their components (including ZEVs, batteries, fuels cells, battery components, and critical minerals) and for the development of electric charging and hydrogen refueling infrastructure, with attendant benefits for employment and US global competitiveness in these sectors; and increased use of electric charging and potential for vehicle-to-grid technologies that can benefit electric grid reliability.

Moreover, many of the indirect impacts find close analogs in the impacts Congress itself recognized and accepted. For instance, in 1970 Congress debated whether to adopt standards that would depend heavily on platinum-based catalysts in light of a world-wide shortage of platinum,<sup>178</sup> and in the leadup to the 1977 and 1990 Amendments, Congress recognized that increasing use of three-way catalysts to control motor vehicle pollution risked relying on foreign sources of the critical mineral rhodium.<sup>179</sup> In each case,

<sup>177</sup> As noted, our use of “indirect impacts” in this section refers to impacts beyond those on regulated entities.

<sup>178</sup> See, e.g., Environmental Policy Division of the Congressional Research Service Volume 1, 93d Cong., 2d Sess., A Legislative History of the Clean Air Amendments of 1970 at 307 (Comm. Print 1974) (Senator Griffin opposed the vehicle emissions standards because the vehicle that had been shown capable of meeting the standards used platinum-based catalytic converters and “[a]side from the very high cost of the platinum in the exhaust system, the fact is that there is now a worldwide shortage of platinum and it is totally impractical to contemplate use in production line cars of large quantities of this precious material. . . .”).

<sup>179</sup> See, e.g., 136 Cong. Rec. 5102–04 (1990) and 123 Cong. Rec. 18173–74 (1977) (In debate over both the 1977 and 1990 amendments to the Clean Air Act, some members of Congress supported relaxing NO<sub>x</sub> controls from motor vehicles due to concerns over foreign control of rhodium supplies); see also EPA, Tier 2 Report to Congress, EPA420–

Congress nonetheless enacted statutory standards premised on this technology. Similarly, Congress recognized and accepted the potential for employment impacts caused by the Clean Air Act; it then chose to address such impacts not by limiting EPA’s authority to promulgate motor vehicle rules, but by other measures, such as funding training and employment services for affected workers.<sup>180</sup>

In sum, the final rule is a continuation of what the Administrator has been doing for over fifty years: evaluate updated data on pollution control technologies and set emissions standards accordingly. The rule maintains the fundamental regulatory structure of the existing program and iteratively strengthens the GHG standards from its predecessor Phase 2 rule. The consequences of the rule are not different in kind, and in many key aspects, are smaller than those of Phase 2. And while the rule is associated with indirect impacts, EPA comprehensively assessed such impacts and found that the final rule does not cause significant indirect harms as alleged by commenters and on balance creates net benefits for society. We further discuss our response to the major questions doctrine comments in section 2.1 of the RTC.

*ABT.* Some commenters claim that the ABT program, or fleetwide averaging, or both, exceed EPA’s statutory authority. As further explained in section III.A of the preamble, EPA has long employed fleetwide averaging and ABT compliance provisions. In upholding the first HD final rule that included an averaging provision, the D.C. Circuit rejected a petitioner’s challenge to EPA’s statutory authority for averaging. *NRDC v. Thomas*, 805 F.2d 410, 425 (D.C. Cir. 1986).<sup>181</sup> In the subsequent 1990 amendments, Congress, noting *NRDC v. Thomas* and EPA’s ABT program, “chose not to amend the Clean Air Act to specifically prohibit averaging, banking and trading authority.”<sup>182</sup> “The intention was to retain the status quo,” *i.e.*, EPA’s existing authority to allow ABT and

R–98–008, July 1998, p. E–13 (describing concerns about potential shortages in palladium that could result from the Tier 2 standards).

<sup>180</sup> Public Law 101–549, at sec. 1101, amending the Job Training Partnership Act, 29 U.S.C. 1501 *et seq.* (since repealed).

<sup>181</sup> The court explained that “[l]acking any clear congressional prohibition of averaging, the EPA’s argument that averaging will allow manufacturers more flexibility in cost allocation while ensuring that a manufacturer’s overall fleet still meets the emissions reduction standards makes sense.” *NRDC v. Thomas*, 805 F.2d at 425.

<sup>182</sup> 136 Cong. Rec. 35,367, 1990 WL 1222469, at \*1.

establish fleet average standards.<sup>183</sup> Since then, the agency has routinely used ABT in its motor vehicle programs, including in all of our motor vehicle GHG rules, and repeatedly considered the availability of ABT in determining the level of stringency of fleet average standards. Manufacturers have come to rely on ABT in developing their compliance plans. The agency did not reopen the ABT regulations in this rulemaking, except to make certain discrete changes discussed in section III.A of the preamble. Comments challenging the agency’s authority for ABT regulations and use of fleet averaging are therefore beyond the scope of the rulemaking.

In any event, the CAA authorizes EPA to establish an ABT program and fleet average standards.<sup>184</sup> Section 202(a)(1) directs EPA to set standards “applicable to the emission of any air pollutant from any class or classes of new motor vehicles” that cause or contribute to harmful air pollution. The term “class or classes” refers expressly to groups of vehicles, indicating that EPA may set standards based on the emissions performance of the class as a whole, which is precisely what ABT enables. Moreover, as we detail in section II.G.2 of the preamble, consideration of ABT in standard setting relates directly to considerations of technical feasibility, cost, and lead time, the factors EPA is required to consider under CAA section 202(a)(2) in setting standards. For decades, EPA has found that considering ABT, particularly the averaging provisions, is consistent with the statute and affords regulated entities more flexibility in phasing in technologies in a way that is economically efficient, promotes the goals of the Act, supports vehicle redesign cycles, and responds to market fluctuations, allowing for successful deployment of new technologies and achieving emissions reductions at lower cost and with less lead time.<sup>185</sup>

ABT and fleet average standards are also consistent with other provisions in Title II, including those related to compliance and enforcement in CAA

<sup>183</sup> 136 Cong. Rec. 35,367, 1990 WL 1222469, at \*1; see also 136 Cong. Rec. 36,713, 1990 WL 1222468 at \*1.

<sup>184</sup> As we explain in section II.G of this preamble, EPA relied on averaging, but not banking or trading, in supporting the feasibility of the standards.

<sup>185</sup> Beyond the statute’s general provisions regarding cost and lead time, Congress has also repeatedly endorsed the specific concept of phasing in of advanced emissions control technologies throughout section 202, which is analogous to ABT in that it considers a manufacturer’s production volume and the performance of vehicles across the fleet in determining compliance. See discussion in section I.A of this preamble citing provisions including section 202(g)–(j), 202(b)(1)(C).

sections 203, 206, and 207. Commenters who alleged inconsistency with the compliance and enforcement provisions fundamentally misapprehend the nature of EPA’s HD GHG program and its ABT regulations, where compliance and enforcement do in fact apply to individual vehicles consistent with the statute. It is true that ABT allows manufacturers to meet emissions standards by offsetting emissions credits and debits for individual vehicles. However, individual vehicles must also continue to themselves comply with their own emissions limit, known as the Family Emission Limit (FEL).<sup>186</sup> Both the emission standard and FEL are specified in each vehicle’s individual certificate of conformity, and apply both at certification and throughout that vehicle’s useful life. As appropriate, EPA can suspend, revoke, or void certificates for individual vehicles. Manufacturers’ warranties apply to individual vehicles. EPA and manufacturers perform testing on individual vehicles, and recalls can be implemented based on evidence of non-conformance by a substantial number of individual vehicles within the class. We further discuss our response to this comment, including detailed exposition of each of the relevant statutory provisions, in RTC 10.2.

*ZEVs as part of the regulated class.* We now address related comments that EPA cannot consider averaging, especially of ZEVs, in supporting the feasibility of the standards. Some commenters allege that because ZEVs, in theory, do not emit GHGs, they cannot be part of the “class” of vehicles regulated by EPA under section 202(a)(1), and therefore EPA should not establish standards that consider manufacturers’ ability to produce them. We disagree with these commenters’ reading of the statute, and moreover, as we explain further below, their underlying factual premise—that ZEVs do not emit GHGs—is incorrect.

As discussed in section I.A of the preamble, Congress required EPA to prescribe standards applicable to the emission of any air pollutant from any class or classes of new motor vehicles, which in his judgment cause, or contribute to, air pollution which endangers public health and welfare. Congress defined “motor vehicles” by their function: “any self-propelled vehicle designed for transporting persons or property on a street or highway.”<sup>187</sup> Likewise, with regard to

classes, Congress explicitly contemplated functional categories: “the Administrator may base such classes or categories on gross vehicle weight, horsepower, type of fuel used, or other appropriate factors.”<sup>188</sup> It is indisputable that ZEVs are “new motor vehicles” as defined by the statute and that they fall into the weight-based “classes” that EPA established with Congress’s explicit support.

In making the GHG Endangerment Finding in 2009, EPA defined the “classes” of motor vehicles and engines as “Passenger cars, light-duty trucks, motorcycles, buses, and medium and heavy-duty trucks.”<sup>189</sup> Heavy-duty ZEVs fall within the class of heavy-duty trucks. EPA did not reopen the 2009 GHG Endangerment Finding in this rulemaking, and therefore comments on whether ZEVs are part of the “class” subject to GHG regulation are beyond the scope of this rulemaking.

Some commenters contend that ZEVs fall outside of EPA’s regulatory reach under this provision because they do not cause, or contribute to, air pollution which endangers human health and welfare. That misreads the statutory text. As we explained previously in regard to ABT, section 202(a)(1)’s focus on regulating emissions from “class or classes” indicates that Congress was concerned with the air pollution generated by a class of vehicles, as opposed to from individual vehicles. Accordingly, Congress authorized EPA to regulate *classes* of vehicles, and EPA has concluded that the *class* of heavy-duty vehicles, as a whole causes or contributes to dangerous pollution. As noted, the *class* of heavy-duty vehicles includes ZEVs, along with ICE and hybrid vehicles. EPA has consistently viewed heavy-duty motor vehicles as a class of motor vehicles for regulatory purposes, including in the HD GHG Phase 1 and Phase 2 rules. As discussed in section I.A of the preamble, EPA has reasonably further subcategorized vehicles within the class based on weight and functionality to recognize real-world variations in emission control technology, ensure consumer access to a wide variety of vehicles to meet their mobility needs, and secure continued emissions reductions for all vehicle types.

These commenters also misunderstand the broader statutory scheme. Congress directed EPA to apply

the standards to vehicles whether they are designed as complete systems or incorporate devices to prevent or control pollution. Thus, Congress understood that the standards may be premised on and lead to technologies that prevent pollution in the first place. It would be perverse to conclude that in a scheme intended to control the emissions of dangerous pollution, Congress would have prohibited EPA from premising its standards on controls that completely prevent pollution, while also permitting the agency to premise them on a technology that reduces 99 percent of pollution. Such a nonsensical reading of the statute would mean that the availability of technology that can reduce 99 percent of pollution could serve as the basis for highly protective standards, while the availability of a technology that completely prevents the pollution could not be relied on to set emission standards at all. Such a reading would also create a perverse safe harbor allowing polluting vehicles to be perpetually produced, resulting in harmful emissions and adverse impacts on public health, even where available technology permits the complete prevention of such emissions and adverse impacts at a reasonable cost. That result cannot be squared with section 202(a)(1)’s purpose to reduce emissions that “cause or contribute to air pollution which may reasonably be anticipated to endanger public health or welfare,”<sup>190</sup> or with the statutory directive to not only “control” but also “prevent” pollution.

Commenters’ suggestion that EPA define the class to exclude ZEVs would also be unreasonable and unworkable. *Ex ante*, EPA does not know which vehicles a manufacturer may produce and, without technological controls including add-on devices and complete systems, *all* of the vehicles have the potential to emit dangerous pollution.<sup>191</sup> Therefore, EPA establishes standards for the entire class of vehicles, based upon its consideration of all available technologies. It is only after the manufacturers have applied those technologies to vehicles in actual production that the pollution is prevented or controlled. To put it differently, even hypothetically assuming EPA could not set standards

<sup>190</sup> See also *Coal. for Responsible Regul.*, 684 F.3d at 122 (explaining that the statutory purpose is to “prevent reasonably anticipated endangerment from maturing into concrete harm”).

<sup>191</sup> As noted, manufacturers in some cases choose to offer different models of the same vehicle with different levels of electrification. And it is the manufacturer who decides whether a given vehicle will be manufactured to produce no emissions, low emissions, or higher aggregate emissions controlled by add-on technology.

<sup>186</sup> See 40 CFR 1037.801 (adoption of FEL); 1037.105, 1037.106 (FEL appears on certificate of compliance). See generally RTC 10.2.1.d.

<sup>187</sup> CAA section 216(2).

<sup>188</sup> CAA section 202(a)(3)(A)(ii). This section applies to standards established under section 202(a)(3), not to standards otherwise established under section 202(a)(1). But it nonetheless provides guidance on what kinds of classifications and categorizations Congress thought were appropriate.

<sup>189</sup> 74 FR 66496, 66537, December 15, 2009.

for vehicles that manufacturers intend to build as electric vehicles—a proposition which we do not agree with—EPA could still regulate vehicles manufacturers intend *not* to build as electric vehicles and that would emit dangerous pollution in the absence of EPA regulation.<sup>192</sup> When regulating those vehicles, Congress explicitly authorized EPA to premise its standards for those vehicles on a “complete system” technology that prevents pollution entirely, like ZEV technologies.

Finally, the commenters’ argument is factually flawed. All vehicles, including ZEVs,<sup>193</sup> do in fact produce vehicle emissions. For example, all ZEVs produce emissions from brake and tire wear, as discussed in RIA Chapter 4. Furthermore, ZEVs have air conditioning units, which may produce GHG emissions from leakages, and these emissions are subject to regulation under the Act. Thus, even under the commenter’s reading of the statute, ZEVs would be part of the class for GHG regulation.<sup>194</sup> We further address this issue in RTC 10.2.1.f, where we also discuss the related contention that ZEVs cannot be part of the same class because electric and ICE powertrains are fundamentally different.

*202(a)(3)(B) and 202(a)(3)(C) lead time and stability.* Finally, we address the comments regarding the applicability of the 4-year lead time and 3-year stability provisions in CAA section 202(a)(3)(C). As we noted in the HD Phase 1 final rule, the provision is not applicable here.<sup>195</sup> Section 202(a)(3)(C) only applies to emission

<sup>192</sup> In other words, the additional ZEVs EPA projects in the modeled potential compliance pathway exist in the baseline case as pollutant-emitting vehicles with ICE. We further note that it would be odd for EPA to have authority to regulate a given class of motor vehicles—in this case heavy-duty motor vehicles—so long as those vehicles emit air pollution at the tailpipe, but to lose its authority to regulate those very same vehicles should they install emission control devices to limit such pollution or be designed to prevent the endangering pollution in the first place.

<sup>193</sup> As discussed in the Executive Summary, we use the term ZEVs to refer to vehicles that result in zero tailpipe emissions, such as battery electric vehicles and fuel cell electric vehicles. While vehicles equipped with H2-ICE engines emit zero engine-out CO<sub>2</sub> emissions, H2-ICE vehicles emit criteria pollutants and are therefore not included in our references to ZEVs.

<sup>194</sup> Moreover, as already explained, manufacturers do not have to produce ZEVs to comply with the final standards. EPA’s modeling of the alternate compliance pathway in section II.F.3 demonstrates that manufacturers could meet the standard using solely advanced technologies with ICEs.

<sup>195</sup> Greenhouse Gas Emissions Standards and Fuel Efficiency Standards for Medium- and Heavy-Duty Engines and Vehicles EPA Response to Comments Document for Joint Rulemaking, at 5–19 (“Phase 1 RTC”).

standards for heavy-duty vehicles for the listed pollutants in section 202(a)(3)(A) or to revisions of such standards under 202(a)(3)(B). Section 202(a)(3) applies only to standards for enumerated pollutants, none of which are GHGs, namely, “hydrocarbons, carbon monoxide, oxides of nitrogen, and particulate matter.” Because this rule does not establish standards for any pollutant listed in section 202(a)(3)(A), that section clearly does not apply. Neither does section 202(a)(3)(B), which is limited to revisions of heavy-duty standards “promulgated under, or before the date of, the enactment of the Clean Air Act Amendments of 1990.” EPA’s heavy-duty GHG standards, however, have consistently been promulgated under sections 202(a)(1)–(2), statutory provisions which were not enacted or revised by the 1990 amendments. Nor does the final rule revise any standard promulgated “before” the enactment of the 1990 amendments. Consequently, the four year lead time and three year stability requirements of section 202(a)(3)(C) are inapplicable. We further address this issue in RTC 2.3.3 and 2.11.

## II. Final HD Phase 3 GHG Emission Standards

Under our CAA section 202(a)(1) and (2) authority, we are finalizing new Phase 3 GHG standards for MYs 2027 through 2032 and later HD vehicles. In this section II, we describe our assessment that the new Phase 3 GHG standards are appropriate and feasible considering lead time, costs, and other relevant factors. These final Phase 3 standards include (1) revised GHG standards for many MY 2027 HD vehicles, and (2) new GHG standards starting in MYs 2028 through 2032. Our development of the final standards considered all of the substantive comments received, including those that advocated stringency levels ranging from less stringent than the lower stringency alternative presented in the NPRM to values that would be comparable with stringency levels in the California Advanced Clean Truck (ACT) rule such as stringency levels comparable to 50- to 60-percent utilization of ZEV technologies range and beyond.

The final standards’ feasibility is supported through our analysis reflecting one modeled potential compliance pathway, but the final standards do not mandate the use of any specific technology. EPA anticipates that a compliant fleet under the final standards will include a diverse range of technologies, including ZEV and ICE vehicle technologies, and we have also

included additional example potential compliance pathways that meet and support the feasibility of the final standards including without producing additional ZEVs to comply with this rule. In developing the modeled potential compliance pathway on which the feasibility of the final standards is supported, EPA has considered the key issues associated with growth in penetration of zero-emission vehicles, including charging and refueling infrastructure and critical mineral availability. In this section, we describe our assessment of the appropriateness and feasibility of these final standards and support that assessment with a potential technology pathway for achieving each of those standards through increased utilization of ZEV and vehicles with ICE technologies, as well as additional technology pathways to meet the final standards using technologies for vehicles with ICE. In this section, we also present an alternative set of standards (“the alternative”) that we additionally developed and analyzed but are not adopting, that reflects an even more gradual phase-in and lower final stringency level than the final standards. Furthermore, we also developed but did not analyze alternative standards reflecting levels of stringency more stringent than the final standards that would be achieved from extrapolating the California ACT rule to the national level, that we are also not adopting.

In the beginning of this section, we first describe the public health and welfare need for GHG emission reductions (section II.A). In section II.B, we provide an overview of the comments the Agency received on the NPRM regarding the proposed Phase 3 GHG emission standards, an overview of the final standards, and updates to the analyses that support these standards. In section II.C, we provide a brief overview of the existing CO<sub>2</sub> emission standards that we promulgated in HD GHG Phase 2. Section II.D contains our technology assessment for the projected potential compliance pathway that supports the feasibility of the standards and section II.E includes our assessment of technology costs, EVSE costs, operating costs, and payback for that modeled potential compliance pathway. Section II.F sets out the final standards and the analysis demonstrating their feasibility, including additional example potential compliance pathways that meet and support the feasibility of the final including without producing additional ZEVs to comply with this rule. Section II.G discusses the appropriateness of the

final emission standards under the Clean Air Act. Section II.H presents the alternative set of standards to the final standards that we considered but are not adopting. Finally, section II.I summarizes our consideration of small businesses.

The HD Phase 3 GHG standards are CO<sub>2</sub> vehicle exhaust standards; other GHG standards under the existing regulations for HD engines and vehicles remain applicable. As we explained in the proposal, we did not reopen and are not amending the other GHG standards, including nitrous oxide (N<sub>2</sub>O), methane (CH<sub>4</sub>), and CO<sub>2</sub> emission standards that apply to heavy-duty engines and the HFC emission standards that apply to heavy-duty vehicles, or the general compliance structure of existing 40 CFR part 1037 except for some revisions described in sections II and III.<sup>196</sup> As also explained in the proposal, we did not reopen and are continuing the existing approach taken in both HD GHG Phase 1 and Phase 2, that compliance with the vehicle exhaust CO<sub>2</sub> emission standards is based on CO<sub>2</sub> emissions from the vehicle. Indeed, all of our vehicle emission standards are based on vehicle emissions. See 76 FR 57123 (September 15, 2011); see also 77 FR 51705 (August 24, 2012), 77 FR 51500 (August 27, 2012), and 81 FR 75300 (October 25, 2016). We respond to the comments we received on life cycle emissions in relation to standard setting in RTC section 17.1. Additionally, as proposed in the combined light-duty and medium-duty rulemaking, in a separate rulemaking we intend to finalize more stringent standards for complete and incomplete vehicles at or below 14,000 pounds GVWR that are certified under 40 CFR part 86, subpart S. This Phase 3 final rule does not alter manufacturers of incomplete vehicles at or below 14,000 pounds GVWR continuing to have the option of either meeting the greenhouse gas standards under 40 CFR parts 1036 and 1037, or instead meeting the greenhouse gas standards with chassis-based measurement procedures under 40 CFR part 86, subpart S.

<sup>196</sup> See the HD GHG Phase 2 rule (81 FR 73478, October 25, 2016), the Heavy-Duty Engine and Vehicle Technical Amendment rule (86 FR 34308, June 29, 2021), and the HD2027 rule (88 FR 4296, January 24, 2023). In this rulemaking, EPA did not reopen any portion of our heavy-duty compliance provisions, flexibilities, and testing procedures, including those in 40 CFR parts 1037, 1036, and 1065, other than those specifically identified in our proposal. For example, while EPA is revising discrete elements of the HD ABT program, EPA did not reopen the general availability of ABT.

*A. Public Health and Welfare Need for GHG Emission Reductions*

The transportation sector is the largest U.S. source of GHG emissions, representing 29 percent of total GHG emissions and, within the transportation sector, heavy-duty vehicles are the second largest contributor at 25 percent.<sup>197</sup> GHG emissions have significant impacts on public health and welfare as set forth in EPA’s 2009 Endangerment and Cause or Contribute Findings under CAA section 202(a) and as evidenced by the well-documented scientific record.<sup>198</sup>

Elevated concentrations of GHGs have been warming the planet, leading to changes in the Earth’s climate including changes in the frequency and intensity of heat waves, precipitation, and extreme weather events; rising seas; and retreating snow and ice. The changes taking place in the atmosphere as a result of the well-documented buildup of GHGs due to human activities are altering the climate at a pace and in a way that threatens human health, society, and the natural environment. While EPA is not making any new scientific or factual findings with regard to the well-documented impact of GHG emissions on public health and welfare in support of this rule, EPA is providing some scientific background on climate change to offer additional context for this rulemaking and to increase the public’s understanding of the environmental impacts of GHGs.

Extensive additional information on climate change is available in the scientific assessments and the EPA documents that are briefly described in this section, as well as in the technical and scientific information supporting them. One of those documents is EPA’s 2009 Endangerment and Cause or Contribute Findings for Greenhouse Gases Under section 202(a) of the CAA (74 FR 66496, December 15, 2009). In the 2009 Endangerment Finding, the Administrator found under section 202(a) of the CAA that elevated atmospheric concentrations of six key well-mixed GHGs—CO<sub>2</sub>, methane (CH<sub>4</sub>), nitrous oxide (N<sub>2</sub>O), hydrofluorocarbons (HFCs), perfluorocarbons (PFCs), and sulfur hexafluoride (SF<sub>6</sub>)—“may reasonably be anticipated to endanger the public health and welfare of current

<sup>197</sup> EPA (2023). Inventory of U.S. Greenhouse Gas Emissions and Sinks: 1990–2021 (EPA–430–R–23–002, published April 2023).

<sup>198</sup> See 74 FR 66496, December 15, 2009; see also EPA’s Denial of Petitions Relating to the Endangerment and Cause or Contribute Findings for Greenhouse Gases Under Section 202(a) of the Clean Air Act, available at [https://www.epa.gov/system/files/documents/2022-04/decision\\_document.pdf](https://www.epa.gov/system/files/documents/2022-04/decision_document.pdf).

and future generations” (74 FR 66523). The 2009 Endangerment Finding, together with the extensive scientific and technical evidence in the supporting record, documented that climate change caused by human emissions of GHGs (including HFCs) threatens the public health of the U.S. population. It explained that by raising average temperatures, climate change increases the likelihood of heat waves, which are associated with increased deaths and illnesses (74 FR 66497). While climate change also increases the likelihood of reductions in cold-related mortality, evidence indicates that the increases in heat mortality will be larger than the decreases in cold mortality in the United States (74 FR 66525). The 2009 Endangerment Finding further explained that compared with a future without climate change, climate change is expected to increase tropospheric ozone pollution over broad areas of the United States., including in the largest metropolitan areas with the worst tropospheric ozone problems, and thereby increase the risk of adverse effects on public health (74 FR 66525). Climate change is also expected to cause more intense hurricanes and more frequent and intense storms of other types and heavy precipitation, with impacts on other areas of public health, such as the potential for increased deaths, injuries, infectious and waterborne diseases, and stress-related disorders (74 FR 66525). Children, the elderly, and the poor are among the most vulnerable to these climate-related health effects (74 FR 66498).

The 2009 Endangerment Finding also documented, together with the extensive scientific and technical evidence in the supporting record, that climate change touches nearly every aspect of public welfare<sup>199</sup> in the United States., including the following: changes in water supply and quality due to changes in drought and extreme rainfall events; increased risk of storm surge and flooding in coastal areas and land loss due to inundation; increases in peak electricity demand and risks to electricity infrastructure; and the potential for significant agricultural disruptions and crop failures (though offset to a lesser extent by carbon fertilization). These impacts are also

<sup>199</sup> The CAA states in section 302(h) that “[a]ll language referring to effects on welfare includes, but is not limited to, effects on soils, water, crops, vegetation, manmade materials, animals, wildlife, weather, visibility, and climate, damage to and deterioration of property, and hazards to transportation, as well as effects on economic values and on personal comfort and well-being, whether caused by transformation, conversion, or combination with other air pollutants.” 42 U.S.C. 7602(h).

global and may exacerbate problems outside the United States that raise humanitarian, trade, and national security issues for the U.S. (74 FR 66530).

The most recent information demonstrates that the climate is continuing to change in response to the human-induced buildup of GHGs in the atmosphere. Recent scientific assessments show that atmospheric concentrations of GHGs have risen to a level that has no precedent in human history and that they continue to climb, primarily because of both historic and current anthropogenic emissions, and that these elevated concentrations endanger our health by affecting our food and water sources, the air we breathe, the weather we experience, and our interactions with the natural and built environments.

Global average temperature has increased by about 1.1 degrees Celsius (°C) (2.0 degrees Fahrenheit (°F)) in the 2011–2020 decade relative to 1850–1900. The IPCC determined with medium confidence that this past decade was warmer than any multi-century period in at least the past 100,000 years. Global average sea level has risen by about 8 inches (about 21 centimeters (cm)) from 1901 to 2018, with the rate from 2006 to 2018 (0.15 inches/year or 3.7 millimeters (mm)/year) almost twice the rate over the 1971 to 2006 period, and three times the rate of the 1901 to 2018 period. The rate of sea level rise during the 20th Century was higher than in any other century in at least the last 2,800 years. The CO<sub>2</sub> being absorbed by the ocean has resulted in changes in ocean chemistry due to acidification of a magnitude not seen in 65 million years<sup>200</sup> putting many marine species—particularly calcifying species—at risk. Human-induced climate change has led to heatwaves and heavy precipitation becoming more frequent and more intense, along with increases in agricultural and ecological droughts<sup>201</sup> in many regions.<sup>202</sup> The 4th National

<sup>200</sup> IPCC (2018): Global Warming of 1.5 °C. An IPCC Special Report on the impacts of global warming of 1.5 °C above pre-industrial levels and related global greenhouse gas emission pathways, in the context of strengthening the global response to the threat of climate change, sustainable development, and efforts to eradicate poverty [Masson-Delmotte, V., P. Zhai, H.-O. Portner, D. Roberts, J. Skea, P.R. Shukla, A. Pirani, W. Moufouma-Okia, C. Pe'an, R. Pidcock, S. Connors, J.B.R. Matthews, Y. Chen, X. Zhou, M.I. Gomis, E. Lonnoy, T. Maycock, M. Tignor, and T. Waterfield (eds.)].

<sup>201</sup> These are drought measures based on soil moisture.

<sup>202</sup> IPCC (2021): Summary for Policymakers. In: Climate Change 2021: The Physical Science Basis. Contribution of Working Group I to the Sixth

Climate Assessment (NCA4) found that it is very likely (greater than 90 percent likelihood) that by mid-century, the Arctic Ocean will be almost entirely free of sea ice by late summer for the first time in about 2 million years.<sup>203</sup> Coral reefs will be at risk for almost complete (99 percent) losses with 1 °C (1.8 °F) of additional warming from today (2 °C or 3.6 °F since preindustrial). At this temperature, between 8 and 18 percent of animal, plant, and insect species could lose over half of the geographic area with suitable climate for their survival, and 7 to 10 percent of rangeland livestock would be projected to be lost. The IPCC similarly found that climate change has caused substantial damages and increasingly irreversible losses in terrestrial, freshwater, and coastal and open ocean marine ecosystems.<sup>204</sup>

In 2016, the Administrator issued a similar finding for GHG emissions from aircraft under section 231(a)(2)(A) of the CAA.<sup>205</sup> In the 2016 Endangerment Finding, the Administrator found that the body of scientific evidence amassed in the record for the 2009 Endangerment Finding compellingly supported a similar endangerment finding under CAA section 231(a)(2)(A), and also found that the science assessments released between the 2009 and 2016 Findings “strengthen and further support the judgment that GHGs in the atmosphere may reasonably be anticipated to endanger the public health and welfare of current and future generations” (81 FR 54424). Pursuant to the 2009 Endangerment Finding, CAA

Assessment Report of the Intergovernmental Panel on Climate Change [Masson-Delmotte, V., P. Zhai, A. Pirani, S.L. Connors, C. Pe'an, S. Berger, N. Caud, Y. Chen, L. Goldfarb, M.I. Gomis, M. Huang, K. Leitzell, E. Lonnoy, J.B.R. Matthews, T.K. Maycock, T. Waterfield, O. Yelekci, R. Yu and B. Zhou (eds.)]. Cambridge University Press.

<sup>203</sup> USGCRP (2018): Impacts, Risks, and Adaptation in the United States: Fourth National Climate Assessment, Volume II [Reidmiller, D.R., C.W. Avery, D.R. Easterling, K.E. Kunkel, K.L.M. Lewis, T.K. Maycock, and B.C. Stewart (eds.)]. U.S. Global Change Research Program, Washington, DC, USA, 1515 pp. doi: 10.7930/NCA4.2018.

<sup>204</sup> IPCC (2022): Summary for Policymakers [H.-O. Pörtner, D.C. Roberts, E.S. Poloczanska, K. Mintenbeck, M. Tignor, A. Alegría, M. Craig, S. Langsdorf, S. Lösschke, V. Möller, A. Okem (eds.)]. In: Climate Change 2022: Impacts, Adaptation and Vulnerability. Contribution of Working Group II to the Sixth Assessment Report of the Intergovernmental Panel on Climate Change [H.-O. Pörtner, D.C. Roberts, M. Tignor, E.S. Poloczanska, K. Mintenbeck, A. Alegría, M. Craig, S. Langsdorf, S. Lösschke, V. Möller, A. Okem, B. Rama (eds.)]. Cambridge University Press, Cambridge, UK and New York, NY, USA, pp. 3–33, doi:10.1017/9781009325844.001.

<sup>205</sup> “Finding that Greenhouse Gas Emissions from Aircraft Cause or Contribute to Air Pollution That May Reasonably Be Anticipated to Endanger Public Health and Welfare.” 81 FR 54422, August 15, 2016. (“2016 Endangerment Finding”).

section 202(a) requires EPA to issue standards applicable to emissions of those pollutants from new motor vehicles. See *Coalition for Responsible Regulation*, 684 F.3d at 116–125, 126–27; *Massachusetts*, 549 U.S. at 533. See also *Coalition for Responsible Regulation*, 684 F.3d at 127–29 (upholding EPA’s light-duty GHG emission standards for MYs 2012–2016 in their entirety).<sup>206</sup> Since the 2016 Endangerment Finding, the climate has continued to change, with new observational records being set for several climate indicators such as global average surface temperatures, GHG concentrations, and sea level rise. Additionally, major scientific assessments continue to be released that further advance our understanding of the climate system and the impacts that GHGs have on public health and welfare both for current and future generations. These updated observations and projections document the rapid rate of current and future climate change both globally and in the United States.<sup>207 208 209 210</sup>

### B. Summary of Comments and the HD GHG Phase 3 Standards and Updates From Proposal

EPA proposed this third phase of GHG standards for heavy-duty vehicles

<sup>206</sup> See also EPA’s Denial of Petitions Relating to the Endangerment and Cause or Contribute Findings for Greenhouse Gases Under Section 202(a) of the Clean Air Act (April 2022), available at [https://www.epa.gov/system/files/documents/2022-04/decision\\_document.pdf](https://www.epa.gov/system/files/documents/2022-04/decision_document.pdf).

<sup>207</sup> USGCRP, 2018: Impacts, Risks, and Adaptation in the United States: Fourth National Climate Assessment, Volume II [Reidmiller, D.R., C.W. Avery, D.R. Easterling, K.E. Kunkel, K.L.M. Lewis, T.K. Maycock, and B.C. Stewart (eds.)]. U.S. Global Change Research Program, Washington, DC, USA, 1515 pp. doi: 10.7930/NCA4.2018. <https://nca2018.globalchange.gov>.

<sup>208</sup> Roy, J., P. Tschakert, H. Waisman, S. Abdul Halim, P. Antwi-Agyei, P. Dasgupta, B. Hayward, M. Kanninen, D. Liverman, C. Okereke, P.F. Pinho, K. Riahi, and A.G. Suarez Rodriguez, 2018: Sustainable Development, Poverty Eradication and Reducing Inequalities. In: *Global Warming of 1.5 °C. An IPCC Special Report on the impacts of global warming of 1.5 °C above pre-industrial levels and related global greenhouse gas emission pathways, in the context of strengthening the global response to the threat of climate change, sustainable development, and efforts to eradicate poverty* [Masson-Delmotte, V., P. Zhai, H.-O. Pörtner, D. Roberts, J. Skea, P.R. Shukla, A. Pirani, W. Moufouma-Okia, C. Pe’an, R. Pidcock, S. Connors, J.B.R. Matthews, Y. Chen, X. Zhou, M.I. Gomis, E. Lonnoy, T. Maycock, M. Tignor, and T. Waterfield (eds.)]. In Press. <https://www.ipcc.ch/sr15/Chapter/Chapter-5>.

<sup>209</sup> National Academies of Sciences, Engineering, and Medicine. 2019. *Climate Change and Ecosystems*. Washington, DC: The National Academies Press. <https://doi.org/10.17226/25504>.

<sup>210</sup> NOAA National Centers for Environmental Information, State of the Climate: Global Climate Report for Annual 2020, published online January 2021, retrieved on February 10, 2021, from <https://www.ncdc.noaa.gov/sotc/global/202013>.

and supported the feasibility of those proposed standards based on our assessment of a projected compliance pathway using ZEV technologies and ICE vehicle technologies. As described further in the NPRM, the proposed standards commenced in MY 2027 for most of the HDV subcategories, and in MY 2030 for sleeper cab (long-haul) tractors. The proposed standards would increase in stringency through MY 2032, after which they would remain in place unless and until EPA set new standards (e.g., Phase 4 standards).

The proposed vehicle standards were performance-based standards and did not specify or require use of any particular technology. The technology packages developed to support the feasibility of the proposed HD GHG Phase 3 vehicle standards included those improvements to ICE vehicle performance reflected in the HD GHG Phase 2 standards' technology packages. EPA did not reopen and did not propose any revisions to the HD Phase 2 engine GHG standards.

1. Summary of Comments

There were many comments on EPA's proposal. Certain commenters supported the proposed stringency levels and the proposed MY implementation schedule. Regarding the proposed implementation schedule, for example, one commenter supported EPA's proposal to amend many of the MY 2027 Phase 2 vehicle standards on the grounds advanced by EPA at proposal: facts have changed from 2016 when the agency promulgated its Phase 2 rule. Specifically, ZEVs are being actively deployed, there are plans to increase their adoption rate, and massive Federal and state efforts are underway to provide financial incentives and otherwise encourage heavy-duty ZEV implementation. The bulk of comments, however, supported standards of either greater or lesser stringency than proposed.

This preamble section summarizes these comments at a high level and highlights certain changes we have made in the final standards from those proposed after consideration of these comments. Detailed summaries and responses are found in section 2 of the RTC.<sup>211</sup>

i. Comments Urging Standards More Stringent Than Proposed

A number of commenters maintained that the proposed standards were

<sup>211</sup> For the complete set of comments, please see U.S. EPA, "Greenhouse Gas Emissions Standards for Heavy-Duty Vehicles—Phase 3—Response to Comments," RTC sections 2 and 3. Docket EPA-HQ-OAR-2022-0985.

insufficiently stringent. Many of these commenters centered their arguments on general legal and policy grounds, maintaining that the overriding public health and welfare protection goals of the Act and of section 202(a)(1) should be reflected in standard stringency. They pointed to the on-going climate crisis and indicated that emission reduction levels should be commensurate with the degree of harm posed by that endangerment. A number of these commenters also stressed the need for reductions in criteria pollutant emissions including via further improvements to ICE vehicles (both through vehicle and engine standards), stressing especially the benefits to disadvantaged communities that would be afforded by more stringent standards.

This group of commenters recommended standards at least as stringent as those in the California ACT rules. Other commenters suggested standards stricter still, including a standard of zero emission by MY 2035, basing the standard on the combined stringencies of the California ACT and Advanced Clean Fleets (ACF) programs (citing the record developed by California in support of each of these programs), and including the ACT sales mandates as part of a Federal standard. One commenter indicated that the baseline should account for both California programs, these programs' adoption by the CAA section 177 states, their presumed adoption by the NESCAUM MOU states, effects of the IRA and BIL, state and local initiatives, and manufacturer and fleet commitments.

As further support for more stringent standards, commenters cited a number of factors, including asserting the following, which we summarize and respond to in RTC section 2.4 or elsewhere as noted:

- Introduction into the market of HD ZEVs, numerous both in volume and types of applications. More specifically, CARB staff found (in the administrative record for the California ACF program) that ZEVs are available in every weight class of trucks, and each weight class includes a wide range of vehicle applications and configurations. CARB staff also found that there are currently 148 models in North American where manufacturers are accepting orders or pre-orders, and there are 135 models that are actively being supported and delivered. These commenters pointed to manufacturer sales announcements and publicly announced production plans as corroboration.

- Adoption of ACT by other states, plus commitments of other states to do so, indicates standards reflecting that

level of ZEV acceptance can be replicated on a national basis.

- Massive Federal, state and local financial incentives in the BIL, IRA and elsewhere. See also RTC section 2.7.

- Federal standards themselves will provide needed certainty for investment in both ZEVs, including metals and minerals critical to battery production, and charging infrastructure.

- Tens of billions of dollars of announced investments from the private sector and utilities into charging infrastructure for heavy-duty ZEVs, as well as supporting state and local actions designed to ensure that the rate, scale, and distribution of infrastructure buildout supports rapid and diverse adoption of heavy-duty ZEVs.

Another commenter (to which we respond in RTC section 2.4) asserted a number of points, for which they provided empirical support, related to cost of BEVs in relation to comparable ICE-powered HDVs:

- Powertrain costs of most BEVs will be at par or cheaper than diesel ICE vehicles due to the battery tax credits under the IRA.

- The Total Cost of Ownership (TCO) of BEVs is significantly lower than diesel ICE vehicles across all segments. The payback period is less than three years for all vehicles.

- The cargo capacity of most BEVs will be at par with ICEVs due to a posited increase in battery energy density.

- 15 minutes of enroute charging from a megawatt charging system can add more than 80 percent of the full range of battery electric tractors, enabling them to meet the requirements of more demanding use cases.

- BEVs have a lower TCO per mile, even assuming significant public charging. With 30 percent of all charging required conducted en route (recharging 20–80 percent of a full charge on half of the operating days), the payback period of all HDVs is still less than five years.

A number of commenters urged adoption of more stringent standards predicated on further improvements to engine and vehicle GHG performance of ICE vehicles. The thrust of these comments is that there are various available technologies which either have not been utilized, or are underutilized, in the HDV fleet, and that significant incremental improvements in GHG performance are therefore available, and at reasonable cost.

According to these commenters, these technologies include lightweighting, advanced aerodynamics, tire improvements, idle reduction including stop-start systems, hybrid technologies



of all types, and predictive cruise control. Commenters stated that some of these technologies would even improve ZEV performance by increasing vehicle efficiency thereby enabling longer range for a given battery size. We summarize and address comments relating to vehicles with ICE technologies in section 9 of the RTC to this rule.

With regard to specific applications, proponents of more stringent standards stated that:

- Tesla alone intends to produce 50,000 BEV Class 8 day cabs for MY 2024, which on its own would exceed the percentage of ZEVs in the technology package on which EPA supported the proposed MY 2027 standard;
- The proposed standard for tractors could be at ACT levels if predicated on reduced battery size and opportunity (public) charging;
- There are many programs that support zero emission urban and school buses, which should be reflected in the standards;
- Drayage trucks should be subject to a more stringent standard, given their suitability for ZEV technologies (limited range, overnight charging in depots) plus the environmental benefits of reducing emissions given their use in heavily polluted areas like ports and railway yards.

We respond to these comments throughout section II of this preamble and in sections 2 and 3 of the RTC.

#### ii. Comments Urging Standards Less Stringent Than Proposed

Many commenters opposed the proposed standards as being too stringent. Some urged the agency to simply leave the MY 2027 Phase 2 standards in place, maintaining on general grounds that further technological improvements are too nascent to form the basis for more stringent standards. Other comments were more specific on the subject of implausibility. One commenter stated that the number of BEV buses would need to increase by a factor of 12, and that thousands of BEV drayage, day-cab tractors, sleeper tractors, and step vans would need to be sold to achieve the proposed standards. Another commenter asserted that the proposal was predicated on a ZEV sale growth rate of 63,000 percent from 2021–2032. One commenter stated that a predicated introduction of more than two orders of magnitude for some subcategories (0.2 percent to approximately 40 percent) in a few model years was inherently implausible.

Two vehicle manufacturer commenters, on the other hand,

supported the MY 2032 standards but found the early model year standards inappropriate, citing among other things the large increase in stringency between MYs 2026 and 2027 and the uncertainties associated with sufficiency of supportive recharging infrastructure in the program's initial years.

A number of commenters opposed to the proposed standards offered alternative perspectives to some of the points made by commenters supporting more stringent standards. With regard to a nationalized version of the California ACT standards, these commenters asserted that certain assumptions and circumstances reflected in the ACT program would not be replicated nationally, including assumptions of high diesel prices, high ACT vehicle availability, and high demand from California's ACF program, plus local climate conditions which did not require BEVs designed for more extreme weather conditions. A commenter further asserted that not all states that have adopted California's ACT provisions have the same supporting regulations and therefore it is not clear how many ZEVs will be sold as a result of ACT. Others stated that manufacturers' aspirational goals did not translate to actual production, especially given uncertainties regarding supporting electric charging infrastructure, customer reactions to a new, unfamiliar product, and potential critical material shortages.

With respect to further improvements to ICE vehicles and engines suggested by commenters supporting more stringent standards, some manufacturer commenters asserted that some of the technologies on which the Phase 2 rule was predicated had proved unmarketable, others (like the Rankine engine and certain advanced aerodynamic features) had never been commercialized, and some had proved less efficient than projected, and as a result, some manufacturers had included ZEVs within their production plans as a Phase 2 compliance strategy. These commenters stated that non-utilization of various engine and vehicle technologies thus should not be viewed as either showing opportunity for further ICEV improvements, or as demand for BEV vehicles.

Uncertainties relating to key elements of the program which commenters stated are out of the control of the regulated entities formed the basis of many of the comments questioning the feasibility of the proposed program. These include:

- The availability of distribution electrical infrastructure necessary to

support BEVs. Commenters cited the chicken-egg dynamic of ZEV purchasers needing assurance of supporting infrastructure before committing to purchases, but electric utilities needing (and, in many cases, legally requiring) assurance of demand before building out. These difficulties are compounded by issues of timing: it can take 40 weeks for utilities to acquire transformer parts, and 70 to acquire switchgear parts. Installation delays can be 1–3 years for smaller installations (cable, conductor systems), 3–5 years for medium (feeders and substation capacity), and 4–6 for large installations (subtransmission requiring licensing). Moreover, infrastructure buildout schedules rarely correlate with purchasers' resale schedules, or with BIL/IRA subsidy timings. These comments are summarized in more detail and addressed in section II.D.2.iii of this preamble and in RTC section 7 (Distribution).

- Uncertainty regarding availability of critical minerals and associated supply chain issues. These comments are summarized in more detail and addressed in section II.D.2.ii and in RTC section 17.2.

- Uncertainty regarding purchasers' decisions, noting customer reluctance to utilize an unfamiliar technology and unsuitability given limited range and cargo penalty due to need for large batteries. These comments are summarized in more detail and addressed in section II.F.1 of this preamble and in RTC sections 4.2 and 19.5.

- Assertions that estimating availability of hydrogen infrastructure is nearly futile at present because this technology is barely commercialized; commenters suggested that EPA has also mistakenly assumed availability of clean hydrogen, failed to consider costs of hydrogen infrastructure, ignored potential issues of permitting and interfaces with electric utilities with regard to hydrogen infrastructure, and failed to discuss physical requirements of hydrogen charging stations; and that EPA also did not consider issues relating to hydrogen handling or high initial costs of hydrogen infrastructure. These comments are summarized in more detail and addressed in section II.D.3.v and RTC section 8.

Regarding availability of Federal and state funding, these commenters made the following points:

- These subsidies may not be available in many instances, due to insufficient taxable revenue to qualify, or lack of domestic production required to be eligible for the tax subsidy;

- Purchase incentives for tractors are being offset, almost to the dollar, by Federal excise taxes;

- States are using National Electric Vehicle Infrastructure Formula program funds almost exclusively for light duty infrastructure, which will not be suitable for HDVs;

Given all of these uncertainties and issues, this group of commenters questioned the disproportionate weight EPA gave to payback in developing a ZEV-based compliance pathway. One commenter indicated that EPA should accord equal analytical weight to purchase price, limited range, excess weight, lack of electrification infrastructure, durability concerns, and unpromising state support. Commenters also noted the reality of the energy efficiency gap noted by EPA, whereby purchasers refrain from making seemingly economically rational decisions for various reasons.

EPA's proposed approach to quantifying when payback periods of given duration would support utilization of ZEV technologies as a potential compliance option was criticized by these commenters (and also by commenters urging standards of greater stringency). With regard to the payback metric generally, a number of commenters maintained that payback is not a guarantee of technology adoption, pointing to various technologies with rapid payback (like drive wheel fairings) which nonetheless proved unmarketable. These commenters also maintain that TCO is the proper, or superior, metric, better reflecting how purchase decisions are actually made. In any case, these commenters said that a 2-year payback period is more appropriate for HDVs, since initial purchasers typically have a 3- to 5-year resale schedule.

One commenter noted that the projected results based on the modified equation were highly conservative, and inconsistent with the technical literature. Other commenters suggested EPA utilize instead other of the methodologies discussed in the Draft Regulatory Impact Analysis (DRIA) that were not based on a proprietary equation, notably the TEMPO equation and methodology.

One commenter submitted an attachment from ACT Research (who developed the proprietary payback equation EPA had modified in the proposed approach) maintaining that EPA had misapplied the equation. EPA addresses this issue and summarizes in more detail and addresses these comments in section II.F.1 and RTC section 2.4.

With regard to standard stringency, one commenter submitted detailed comments urging that EPA adopt standards roughly 50 percent less stringent than proposed for each subcategory, commencing in MY 2030, with standards for HHD vocational vehicle and sleeper cab tractor applications commencing in MY 2033. Their recommended standards would also include three initial years of stability. This commenter derived these standards using EPA's HD TRUCS tool with different inputs. Reasons supplied by the commenter for the different inputs included omitted costs, underestimated costs, certain errors regarding various of the 101 models included in HD TRUCS, misapplication of the ACT Research payback algorithm, and the following purportedly unrealistic assumptions:

- Timing of infrastructure availability (including issues associated with supply chains for distribution infrastructure equipment, especially in light of overlapping demands from the LDV sector);
- Need to get pro-active involvement of electric utilities, and EPA's seeming lack of effort in encouraging such actions;
- Fuel cell efficiency;
- Lack of consideration of resale value;
- Assumption of domestic battery production, given the absence of any domestic lithium mining;
- The sheer magnitude of infrastructure buildout needed to support the levels of BEVs on which the proposal was predicated (estimated as a need for 15,000 new chargers each week for the next 8 years);
- Unrealistic estimates of cost of hydrogen infrastructure;
- Lack of accounting for land availability; and
- A cargo penalty of 30 percent is a significant deterrent.

This commenter further maintained that its suggested standards be adjusted automatically downwards if any of the assumptions on which a standard is predicated prove unfounded. They specifically suggest that these triggers include a linkage to infrastructure availability, with the standard being automatically reduced based on the percentage of infrastructure less than predicted. This commenter further suggested this linkage trigger could be based on infrastructure buildout in counties known to be freight corridors. In subsequent meetings with the agency, this commenter suggested a further trigger based on monitoring ZEV sales both within states which have adopted the California ACT program, and within

states which have not done so.<sup>212</sup> These comments are summarized in more detail and addressed in section II.B.2.iii and RTC section 2.

Several commenters opposed amendment of the Phase 2 MY 2027 GHG vehicle standards. Some commenters alleged equitability arguments opposing amending the Phase 2 standards. They noted that the Phase 2 standards exhibited a rare consensus, reflecting a common understanding that the standard would remain unaltered through its final model year of phase-in (MY 2027). Some commenters stated that manufacturers have relied on those standards in devising compliance strategies. Moreover, some commenters stated that early adoption of ZEVs is part of the manufacturers' Phase 2 compliance strategies and is not a valid harbinger for a Phase 3 rule. That is, rather than adopt a number of technologies on which the Phase 2 rule was predicated (such as high adoption rates for advanced aerodynamics, stop start, electric steering accessories and others), these commenters stated that some companies instead have introduced ZEVs. These commenters stated that if the MY 2027 standards are amended, these companies are effectively punished for their adoption of an innovative technology, because they will need to seek unanticipated reductions from other vehicles. Some manufacturer commenters stated that if EPA is considering changed circumstances as a basis for amending MY 2027 standards, there are changed circumstances that cut in the other direction: under-utilization of GHG-reducing technologies in ICE vehicles, pandemic altered supply chains, inflationary prices, fewer qualified technicians, and parts shortages.

### iii. Other Comments Related to the Standards

A final group of commenters urged EPA to predicate standards based on use of biofuels or other alternative fuels. They noted that such fuels, including varying degrees of biodiesel, not only provide emission reduction benefits, but can do so immediately, can do so at less cost, and are the subject of various Federal incentive programs, including those administered by the Department of Agriculture. These comments are summarized in more detail and addressed in section II.D.1 and in RTC section 9.1.

<sup>212</sup> Miller, Neil. Memorandum to Docket EPA-HQ-OAR-2022-0985. Summary of Stakeholder Meetings. March 2024.

2. Summary of the Final Rule Standards and Updates From Proposal

This section briefly summarizes the Phase 3 final rule standards and includes discussion of key changes and updates from the proposed standards. This final rule updates the proposal in a number of ways, reflecting consideration of additional data received in comments, other new research that became available since the proposal, and considerations voiced in the public comments. This preamble subsection highlights many of these changes, while the following subsections provide additional detail of the changes.

i. Final Standards

As further described in the following subsections, the final Phase 3 GHG standards include new CO<sub>2</sub> emission standards for MY 2032 and later HD vehicles with more stringent CO<sub>2</sub> standards phasing in as early as MY 2027 for certain vehicle categories. The final standards for the vocational vehicles are shown in Table II–1 and for tractors in Table II–2. The final standards are discussed in detail in section II.F. Compared to the proposed Phase 3 standards, in general, after further consideration of the lead times necessary for the standards (including both the vehicle development and the projected infrastructure needed to support the modeled potential compliance pathway that demonstrates the feasibility of the standards), we are finalizing CO<sub>2</sub> emission standards for heavy-duty vehicles that, compared to the proposed standards, include less stringent standards for all vehicle categories in MYs 2027, 2028, 2029 and 2030. The final standards increase in stringency at a slower pace through MYs 2027 to 2030 compared to the proposal, and day cab tractor standards start in

MY 2028 and heavy heavy-duty vocational vehicles start in MY 2029 (we proposed Phase 3 standards for day cabs and heavy-heavy vocational vehicles starting in MY 2027). As proposed, the final standards for sleeper cabs start in MY 2030 but are less stringent than proposed in that year and in MY 2031, and equivalent to the proposed standards in MY 2032. Our updated analyses for the final rule show that model years 2031 and 2032 GHG standards in the range of those we requested comment on in the HD GHG Phase 3 NPRM are feasible and appropriate considering feasibility, lead time, cost, and other relevant factors as described throughout this section. Specifically, we are finalizing MY 2031 standards that are on par with the proposal for light- and medium-duty vocational vehicles and day cab tractors. Heavy heavy-duty vocational vehicle final standards are less stringent than proposed for all model years, including 2031 and 2032. For MY 2032, we are finalizing more stringent standards than proposed for light and medium heavy-duty vocational vehicles and day cab tractors. EPA also revised various of the optional custom chassis standards from those proposed. Our assessment of the final program as a whole is that it takes a balanced and measured approach while still applying meaningful requirements in MY 2027 and later to reducing GHG emissions from the HD sector.

EPA emphasizes that its standards are performance-based, such that manufacturers are not required to use particular technologies to meet the standards. In this rulemaking, EPA has accounted for a wide range of emissions control technologies, including advanced ICE vehicle technologies (e.g., engine, transmission, drivetrain, aerodynamics, tire rolling resistance improvements, the use of low carbon

fuels like CNG and LNG, and H<sub>2</sub>–ICE), hybrid technologies (e.g., HEV and PHEV), and ZEV technologies (e.g., BEV and FCEV). These include technologies applied to motor vehicles with ICE (including hybrid powertrains) and without ICE. Electrification across the technologies ranges from fully electrified vehicle technologies without an ICE that achieve zero vehicle tailpipe emissions (e.g., BEVs), fuel cell electric vehicle technologies that run on hydrogen and achieve zero tailpipe emissions (e.g., FCEVs), as well as plug-in hybrid partially electrified technologies and ICEs with electrified accessories. There are many potential pathways to compliance with the final standards manufacturers may choose that involve different mixtures of HD vehicle technologies. Our potential compliance pathway that includes a projected mix across the range of HD vehicle technologies, including certain vehicle with ICE, BEV, and FCEV technologies, supports the feasibility of the final standards and was used in our modeling for rulemaking purposes (“modeled potential compliance pathway”). In addition, for the final rule, to further assess the feasibility of the standards under different potential scenarios and to further illustrate that there are many potential pathways to compliance with the final standards that include a wide range of potential technology mixes, we evaluated additional examples of other potential compliance pathway’s technology packages that also support the feasibility of the final standards (“additional example potential compliance pathways”). These additional example potential compliance pathways only include vehicles with ICE technologies and include examples without producing additional ZEVs to comply with this rule.

**Table II-1 Final MY 2027 through 2032+ Vocational Vehicle CO<sub>2</sub> Emission Standards (grams/ton-mile)**

Model Year	Subcategory	CI Light Heavy	CI Medium Heavy	CI Heavy Heavy	SI Light Heavy	SI Medium Heavy
2027	Urban	305	224	269	351	263
	Multi-Purpose	274	204	230	316	237
	Regional	242	190	189	270	219
2028	Urban	286	217	269	332	256
	Multi-Purpose	257	197	230	299	230
	Regional	227	183	189	255	212
2029	Urban	268	209	234	314	248
	Multi-Purpose	241	190	200	283	223
	Regional	212	177	164	240	206
2030	Urban	250	201	229	296	240
	Multi-Purpose	224	183	196	266	216
	Regional	198	170	161	226	199
2031	Urban	198	178	207	244	217
	Multi-Purpose	178	162	177	220	195
	Regional	157	150	146	185	179
2032 and later	Urban	147	155	188	193	194
	Multi-Purpose	132	141	161	174	174
	Regional	116	131	132	144	160

**Table II-2 Final MY 2027 through MY 2032+ Tractor CO<sub>2</sub> Emission Standards (grams/ton-mile)**

Model Year	Roof Height	Class 7 All Cab Styles	Class 8 Day Cab	Class 8 Sleeper Cab
2027	Low Roof	96.2	73.4	64.1
	Mid Roof	103.4	78.0	69.6
	High Roof	100.0	75.7	64.3
2028	Low Roof	88.5	67.5	64.1
	Mid Roof	95.1	71.8	69.6
	High Roof	92.0	69.6	64.3
2029	Low Roof	84.7	64.6	64.1
	Mid Roof	91.0	68.6	69.6
	High Roof	88.0	66.6	64.3
2030	Low Roof	80.8	61.7	60.3
	Mid Roof	86.9	65.5	65.4
	High Roof	84.0	63.6	60.4
2031	Low Roof	69.3	52.8	56.4
	Mid Roof	74.4	56.2	61.2
	High Roof	72.0	54.5	56.6
2032 and later	Low Roof	57.7	44.0	48.1
	Mid Roof	62.0	46.8	52.2
	High Roof	60.0	45.4	48.2

We also are finalizing updates to and new flexibilities that support these final standards, as discussed in section III; however, we did not rely on those other aspects in justifying the feasibility of the final standards.

ii. Updates to Analyses

We have made a number of updates to our analyses from proposal, especially related to inputs to HD TRUCS, as detailed in section II.D.5, after consideration of comments submitted in response to our proposal

and requests for comment in the NPRM. Some of the key updates in our analyses include updates to our assessment of BEV and FCEV component costs, efficiencies, and sizing; consideration of certain additional costs to purchasers, including taxes and insurance; refined dwell times for charging infrastructure sizing; EVSE costs; consideration of public charging (and associated costs) for certain BEVs; and a more detailed evaluation of the impact of HD charging on the U.S. electricity system.

iii. Commitment to Post-Rule Engagement and Monitoring

Some representatives from the heavy-duty vehicle manufacturing industry have expressed not only optimism regarding the heavy-duty industry's ability to produce ZEV technologies in future years at high volume, but also concern that a slow growth in ZEV charging and refueling infrastructure could slow the growth of heavy-duty

ZEV adoption.<sup>213</sup> On the other hand, some representatives from state and local air pollution control agencies point to ongoing and planned activities as evidence that infrastructure for heavy-duty ZEVs can and will be built out at the pace, scale, and locations needed to support such technologies used to meet strong EPA GHG standards for heavy-duty vehicles.<sup>214</sup> Comments from advocacy organizations point to analyses from the International Council on Clean Transportation,<sup>215</sup> as well as announced investments in charging infrastructure from truck manufacturers, fleet owners, retailers, other private companies, and utilities as additional evidence to support this point.<sup>216</sup> Lack of such infrastructure may present challenges for vehicle manufacturers' ability to comply with future EPA GHG standards for manufacturers who pursue a ZEV-focused compliance pathway similar to the example projected potential compliance pathway EPA analyzed in this final rule, while good availability of such infrastructure would support the sale of HD ZEVs and support such a manufacturer's compliance strategy.

EPA has a vested interest in monitoring industry's performance in complying with mobile source emission standards, including the highway heavy-duty industry. EPA currently monitors industry's performance through a range of approaches, including regular meetings with individual companies, regulatory requirements for data submission as part of the annual certification process, and performance under various EPA grant and rebate programs. EPA also provides transparency to the public through actions such as publishing industry compliance reports (such as has been done during the HD GHG Phase 1 program<sup>217</sup>).

We requested comment on the pace of ZEV infrastructure development, and potential implications for compliance

<sup>213</sup> See, e.g., Comments of the Truck and Engine Manufacturers Association. Docket EPA-HQ-OAR-2022-0985-2668.

<sup>214</sup> See, e.g., Comment submitted by the National Association of Clean Air Agencies. Docket EPA-HQ-OAR-2022-0985-1499.

<sup>215</sup> Ragon, P.-L., et al. (2023). Near-term infrastructure deployment to support zero-emission medium- and heavy-duty vehicles in the United States. International Council on Clean Transportation.

<sup>216</sup> See, e.g., Comment submitted by International Council on Clean Transportation. Docket EPA-HQ-OAR-2022-0985-1423.

<sup>217</sup> See EPA Reports EPA-420-R-21-001B covering Model Years 2014-2018, and EPA report EPA-420-R-22-028B covering Model Years 2014-2020, available online at <https://www.epa.gov/compliance-and-fuel-economy-data/epa-heavy-duty-vehicle-and-engine-greenhouse-gas-emissions>.

with the Phase 3 standards in the NPRM. 88 FR 25934. In comments, manufacturers suggest that we establish mechanisms for the CO<sub>2</sub> standards to self-adjust (become less stringent) if infrastructure deployment falls short of the amount necessary to support the rule. We heard similar comments from some Senators suggesting that the compliance deadline be delayed if the infrastructure is not there by a certain date. However, many other stakeholders opposed EPA including in the final rule a self-adjusting linkage between the standards and ZEV infrastructure. Many stakeholders also argued that heavy-duty ZEV infrastructure will be sufficient during the regulatory timeframe to support stronger GHG standards than those proposed by EPA in the NPRM.

We have carefully assessed infrastructure needed for the modeled potential compliance pathway as described in section II.F that supports the feasibility of the final standards, and as described in section II.G we conclude that the Phase 3 standards are feasible and appropriate within the meaning of section 202(a) of the Act. However, EPA also commits in this final rule to actively engage with stakeholders and monitor both OEM compliance and the major elements relating to heavy-duty ZEV infrastructure. EPA, in consultation with other agencies, will issue periodic reports reflecting this collected information throughout the lead up to the Phase 3 standards in MYs 2027 through 2032. These periodic status reports would begin as early as calendar year 2026 with a review of MY 2024 HD vehicle certification data and HD infrastructure growth that occurs over the next two years. As discussed below, these reports will be informed by comprehensive information collected by EPA as part of its certification and compliance programs. The Phase 3 standards are performance-based standards and the projected potential compliance pathway is not the only way that manufacturers may comply with the standards, and thus these reports will include but not be limited to assessing HD ZEV infrastructure. Based on these reports, as appropriate and consistent with CAA section 202(a) authority, EPA may decide to issue guidance documents, initiate a future rulemaking to consider modifications to the Phase 3 rule (including giving appropriate consideration to lead time as required by section 202(a)), or make no changes to the Phase 3 rule program.

EPA has taken similar actions in past rulemakings. For example, in 2000, EPA finalized stringent highway heavy-duty engine emission standards as well as

national ultra-low diesel fuel sulfur standards, with implementation beginning in 2006 (for the fuel) and 2007 for the heavy-duty engines. These standards were premised on significant investments in both diesel fuel sulfur removal technology and heavy-duty engine and vehicle emission control technologies. Because of the significant scope of the regulations and the importance to public health and welfare, EPA published two major progress reports prior to the implementation dates of the standards, with one report published in 2002, and a second report in 2004.<sup>218 219</sup> These public reports allowed EPA to communicate what challenges and progress was being made by the regulated industry and other stakeholders in achieving the goals of the 2000 final rule. EPA believes this previous process for highway heavy-duty emission standards and ultra-low fuel sulfur standards can serve as a broad template for ensuring on-going engagement and monitoring of the Heavy-Duty Phase 3 GHG final standards (though we note for the 2000 rule, EPA established standards for the engine emission requirements and the highway diesel fuel sulfur levels, whereas in this rule EPA is establishing emission standard for heavy-duty vehicles).

As part of the Agency's on-going certification and compliance program, EPA receives data from every OEM to ensure compliance with heavy-duty emission standards, including the existing Phase 2 GHG standards (and, in the future, Phase 3 GHG standards as well). EPA will monitor the on-going implementation of the Phase 2 program as well as the Phase 3 program, to understand how each OEM's compliance with the GHG standards is occurring, including by vehicle class, and to understand the use of the CO<sub>2</sub> emissions averaging, banking, and trading program. This will include evaluating manufacturers' use of Phase 2 advanced technology multipliers, quantifying any banked credits generated from the use of multipliers, and considering the potential for those credits to undermine the overall goals of the Phase 3 program in the MY 2027 and later time frame.

<sup>218</sup> "Highway Diesel Progress Review" EPA Report 420-R-02-016, June 2002. See Docket Entry EPA-HQ-OAR-2022-0985.

<sup>219</sup> "Highway Diesel Progress Review Report 2." EPA-420-R-04-004. March 2004. See Docket Entry EPA-HQ-OAR-2022-0985-77806.

This includes GHG-reducing technologies on HD ICEVs, BEVs, FCEVs, plug-in hybrid electric vehicles (PHEVs), hybrid electric vehicles, and vehicles with H2-ICE. Also consistent with commenters' suggestions, EPA intends to monitor data on HDV sales in California and other states that have adopted ACT. Such sales provide an early indication of ZEV technology adoption.

EPA agrees with commenters that information on battery production, and the related issue of availability of materials critical to that production (including viability of supply chains), is important to gauging pace and success of implementation of the Phase 3 standards. EPA intends to discuss any issues with HD vehicle manufacturers and consult other sources of information regarding these issues, including the United States Geological Survey (USGS) and DOE's tracking of critical minerals.

EPA will monitor the deployment of heavy-duty vehicle charging and hydrogen refueling infrastructure. EPA will begin to collect data in CY 2025 in coordination with DOE and DOT, to monitor the implementation of electric vehicle charging infrastructure designed to serve HD vehicles potentially including but not limited to the following:

- Depot charging infrastructure—number of EVSE ports, size, location, growth rate
- Public charging infrastructure—number of EVSE ports, size, location, growth rate
- EVSE sales—number, size, location, growth rate
- A sample of charging station installation timelines and distribution system upgrades (e.g., covering small, mid-size, and large depots and public stations.) Samples could be selected to reflect different regions and utility types, among other factors.

Additionally, relevant data from each organization's relevant infrastructure funding programs will be assessed.

EPA will also collect data, in coordination with DOE and DOT, on the implementation of hydrogen fueling infrastructure, including data such as the number, capacity, location, and type of hydrogen production plants and hydrogen refueling stations available for HD vehicles.

During the development of the reports reflecting this information, EPA will consult with a wide range of stakeholders regarding the implementation of HD vehicle infrastructure on an on-going basis, to learn from their experiences and to gather relevant information and data

from them. The stakeholders would likely include at a minimum trucking fleets and trucking trade associations; heavy-duty vehicle owner-operators; HD vehicle manufacturers; utilities including investor owned, publicly owned, and cooperatives; infrastructure providers and installers; state & local governments, EJ communities; and NGOs. As noted, we will also be in regular contact with DOE and DOT.

*C. Background on the CO<sub>2</sub> Emission Standards in the HD GHG Phase 2 Program*

In the HD GHG Phase 2 rule, we finalized GHG emission standards tailored to three regulatory categories of HD vehicles—heavy-duty pickups and vans, vocational vehicles, and combination tractors.<sup>220</sup> In addition, we set separate standards for the engines that power combination tractors and for the engines that power vocational vehicles. The heavy-duty vehicle CO<sub>2</sub> emission standards are in grams per ton-mile, which represents the grams of CO<sub>2</sub> emitted to move one ton of payload a distance of one mile. In addition, the Phase 2 program established certain subcategories of vehicles (i.e., custom chassis vocational vehicles and heavy-haul tractors) that were specifically designed to recognize the limitations of certain vehicle applications to adopt some technologies due to specialized operating characteristics or generally low sales volumes with prohibitively long payback periods. The vehicles certified to the custom chassis vocational vehicle standards are not permitted to bank or trade credits and some have limited averaging provisions under the HD GHG Phase 2 ABT program.<sup>221</sup>

1. Vocational Vehicles

Vocational vehicles include a wide variety of vehicle types, spanning Class 2b–8, and serve a wide range of functions. The regulations define vocational vehicles as all heavy-duty vehicles greater than 8,500 pounds GVWR that are not certified under 40 CFR part 86, subpart S, or a combination tractor under 40 CFR 1037.106.<sup>222</sup> Some examples of vocational vehicles include

urban delivery trucks, refuse haulers, utility service trucks, dump trucks, concrete mixers, transit buses, shuttle buses, school buses, emergency vehicles, motor homes, and tow trucks. The HD GHG Phase 2 vocational vehicle program also includes a special regulatory subcategory called vocational tractors, which covers vehicles that are technically tractors but generally operate more like vocational vehicles than line-haul tractors. These vocational tractors include those designed to operate off-road and in certain intra-city delivery routes.

The existing HD GHG Phase 2 CO<sub>2</sub> standards for vocational vehicles are based on the performance of a wide array of control technologies. In particular, the HD GHG Phase 2 vocational vehicle standards recognize detailed characteristics of vehicle powertrains and drivelines. Driveline improvements present a significant opportunity for reducing fuel consumption and CO<sub>2</sub> emissions from vocational vehicles. However, there is no single package of driveline technologies that will be equally suitable for all vocational vehicles, because there is an extremely broad range of driveline configurations available in the market. This is due in part to the variety of final vehicle build configurations, ranging from a purpose-built custom chassis to a commercial chassis that may be intended as a multi-purpose stock vehicle. Furthermore, the wide range of applications and driving patterns of these vocational vehicles leads manufacturers to offer a variety of drivelines, as each performs differently in use.

In the final HD GHG Phase 2 rule, we recognized the diversity of vocational vehicle applications by setting unique vehicle CO<sub>2</sub> emission standards evaluated over composite drive cycles for 23 different regulatory subcategories. The program includes vocational vehicle standards that allow the technologies that perform best at highway speeds and those that perform best in urban driving to each be properly recognized over appropriate drive cycles, while avoiding potential unintended results of forcing vocational vehicles that are designed to serve in different applications to be measured against a single drive cycle. The vehicle CO<sub>2</sub> emissions are evaluated using EPA's Greenhouse Gas Emissions Model (GEM) over three drive cycles, where the composite weightings vary by subcategory, with the intent of balancing the competing pressures to recognize the varying performance of technologies, serve the wide range of customer needs, and maintain a

<sup>220</sup> We also set standards for certain types of trailers used in combination with tractors (see 81 FR 73639, October 25, 2016). As described in section III of this preamble, in this final rule we removed the regulatory provisions related to trailers in 40 CFR part 1037 to carry out the mandate of the U.S. Court of Appeals for the D.C. Circuit, which vacated the portions of the HD GHG Phase 2 final rule that apply to trailers. *Truck Trailer Manufacturers Association v. EPA*, 17 F.4th 1198 (D.C. Cir. 2021).

<sup>221</sup> See 40 CFR 1037.105(h)(2).

<sup>222</sup> See 40 CFR 1037.105(a).

workable regulatory program.<sup>223</sup> The HD GHG Phase 2 primary vocational standards, therefore, contain subcategories for Regional, Multi-purpose, and Urban drive cycles in each of the three weight classes (Light Heavy-Duty (Class 2b–5), Medium Heavy-Duty (Class 6–7) and Heavy Heavy-Duty (Class 8)), for a total of nine unique subcategories.<sup>224</sup> These nine subcategories apply for compression-ignition (CI) vehicles. We separately, but similarly, established six subcategories of spark-ignition (SI) vehicles. In other words, there are 15 separate numerical performance-based emission standards for each model year.

EPA also established optional custom chassis categories in the Phase 2 rule in recognition of the unique technical characteristics of these applications. These categories also recognize that many manufacturers of these custom chassis are not full-line heavy-duty vehicle companies and thus do not have the same flexibilities as other firms in the use of the Phase 2 program emissions averaging program which could lead to challenges in meeting the standards EPA established for the overall vocational vehicle and combination tractor program. We therefore established optional custom chassis CO<sub>2</sub> emission standards for Motorhomes, Refuse Haulers, Coach Buses, School Buses, Transit Buses, Concrete Mixers, Mixed Use Vehicles, and Emergency Vehicles.<sup>225</sup> In total, EPA set CO<sub>2</sub> emission standards for 15 subcategories of vocational vehicles and eight subcategories of specialty vehicle types for a total of 23 vocational vehicle subcategories.

The HD GHG Phase 2 standards phase in over a period of seven years, beginning with MY 2021. The HD GHG Phase 2 program progresses in three-year stages with an intermediate set of standards in MY 2024 and final standards in MY 2027 and later. In the HD GHG Phase 2 final rule, we identified a potential technology path for complying with each of the three increasingly stringent stages of the HD GHG Phase 2 program standards. These

standards' feasibility are demonstrated through a potential technology path that is based on the performance of more efficient engines, workday idle reduction technologies, improved transmissions including mild hybrid powertrains, axle technologies, weight reduction, electrified accessories, tire pressure systems, and tire rolling resistance improvements. We developed the Phase 2 vocational vehicle standards using the methodology where we applied fleet average technology mixes to fleet average baseline vehicle configurations, and each average baseline and technology mix was unique for each vehicle subcategory.<sup>226</sup> When the HD GHG Phase 2 final rule was promulgated in 2016, we established CO<sub>2</sub> standards on the premise that electrification of the heavy-duty market would occur in the future but was unlikely to occur at significant sales volumes of electric vehicles in the timeframe of the program. As a result, the Phase 2 vocational vehicle CO<sub>2</sub> standards were not premised on the application of ZEV technologies, though such technologies could be used by manufacturers to comply with the standards. We finalized BEV, PHEV, and FCEV advanced technology credit multipliers within the HD GHG ABT program to incentivize increased application of these technologies that had the potential for large GHG emission reductions (see section III of this preamble for further discussion on this program and the targeted ways we are amending it). Details regarding the HD GHG Phase 2 standards can be found in the HD GHG Phase 2 final rule preamble and record, and the HD GHG Phase 2 vocational vehicle standards are codified at 40 CFR part 1037.<sup>227</sup>

## 2. Combination Tractors

The tractor regulatory structure is attribute-based in terms of dividing the tractor category into ten subcategories based on the tractor's weight rating, cab configuration, and roof height. The tractors are subdivided into three weight ratings—Class 7 with a gross vehicle weight rating (GVWR) of 26,001 to 35,000 pounds; Class 8 with a GVWR over 33,000 pounds; and Heavy-haul with a gross combined weight rating of greater than or equal to 120,000 pounds.<sup>228</sup> The Class 7 and 8 tractor cab configurations are either day cab or sleeper cab. Day cab tractors are typically used for shorter haul operations, whereas sleeper cabs are often used in long haul operations. EPA

set CO<sub>2</sub> emission standards for 10 tractor subcategories.

Similar to the vocational program, implementation of the HD GHG Phase 2 tractor standards began in MY 2021 and will be fully phased in for MY 2027. In the HD GHG Phase 2 final rule, EPA analyzed the feasibility of achieving the CO<sub>2</sub> standards and identified technology pathways for achieving the standards. The existing HD GHG Phase 2 CO<sub>2</sub> emission standards for combination tractors reflect reductions that can be achieved through improvements in the tractor's powertrain, aerodynamics, tires, idle reduction, and other vehicle systems as demonstrated using GEM. As we did for vocational vehicles, we developed a potential technology package for each of the tractor subcategories that represented a fleet average application of a mix of technologies to demonstrate the feasibility of the standard for each MY.<sup>229</sup> EPA did not premise the HD GHG Phase 2 CO<sub>2</sub> tractor emission standards on application of hybrid powertrains or ZEV technologies. However, we predicted some limited use of these technologies in MY 2021 and beyond and we finalized BEV, PHEV, and FCEV advanced technology credit multipliers within the HD GHG ABT program to incentivize a transition to these technologies (see section III of this preamble for further discussion on this program and the targeted ways we are amending it). More details can be found in the HD GHG Phase 2 final rule preamble, and the HD GHG Phase 2 tractor standards are codified at 40 CFR part 1037.<sup>230</sup>

## 3. Heavy-Duty Engines

In HD GHG Phase 1, we developed a regulatory structure for CO<sub>2</sub>, nitrous oxide (N<sub>2</sub>O), and methane (CH<sub>4</sub>) emission standards that apply to the engine, separate from the HD vocational vehicle and tractor. The regulatory structure includes separate standards for spark-ignition engines (such as gasoline engines) and compression-ignition engines (such as diesel engines), and for heavy heavy-duty (HHD), medium heavy-duty (MHD) and light heavy-duty (LHD) engines, that also apply to alternative fuel engines. We also used this regulatory structure for HD engines in HD GHG Phase 2. More details can be found in the HD GHG Phase 2 final rule preamble, and the HD GHG Phase 2 engine standards are codified at 40 CFR part 1036.<sup>231</sup>

<sup>223</sup> GEM is an EPA vehicle simulation tool used to certify HD vehicles. A detailed description of GEM can be found in the Phase 2 Regulatory Impacts Analysis or at <https://www.epa.gov/regulations-emissions-vehicles-and-engines/greenhouse-gas-emissions-model-gem-medium-and-heavy-duty>.

<sup>224</sup> See 40 CFR 1037.140(g) and (h).

<sup>225</sup> The numeric values of the optional custom chassis standards are not directly comparable to the primary vocational vehicle standards. As explained in the HD GHG Phase 2 rule, there are simplifications in GEM that produce higher or lower CO<sub>2</sub> emissions. 81 FR 73686–73688, October 25, 2016.

<sup>226</sup> 81 FR 73715, October 25, 2016.

<sup>227</sup> 81 FR 73677–73725, October 25, 2016.

<sup>228</sup> See 40 CFR 1037.801.

<sup>229</sup> 81 FR 73602–73611, October 25, 2016.

<sup>230</sup> 81 FR 73571, October 25, 2016.

<sup>231</sup> 81 FR 73553–73571, October 25, 2016.

4. Heavy-Duty Vehicle Averaging, Banking, and Trading Program

Beginning with the HD GHG Phase 1 for HD GHG standards, EPA adopted an ABT program for CO<sub>2</sub> emission credits that allows ABT within a vehicle weight class, meaning that the regulations did not require all vehicles to meet the standard.<sup>232</sup> In promulgating the Phase 2 standards, we explained that the stringency of the Phase 2 standards was derived on a fleet average technology mix basis. For example, we projected that diversified manufacturers would continue to use the averaging provisions in the ABT program to meet the standards on average for each of their vehicle families. For the HD GHG Phase 2 ABT program, we created three weight class-based credit averaging sets for HD vehicles: LHD Vehicles, MHD Vehicles, and HHD Vehicles. This approach allowed ABT between all vehicles in the same weight class, including CI-powered vehicles, SI-powered vehicles, BEVs, FCEVs, and hybrid vehicles, which have the same regulatory useful life. Although the vocational vehicle emission standards are subdivided by Urban, Multi-purpose, and Regional regulatory subcategories, credit exchanges are currently allowed between them within the same weight class. However, these averaging sets currently exclude vehicles certified to the separate optional custom chassis standards. Finally, the ABT program currently allows credits to exchange between vocational vehicles and tractors within a weight class.

ABT is commonly used by vehicle manufacturers to comply with the standards of the HD GHG Phase 2 program. In MY 2022, 93 percent of the certified vehicle families (256 out of 276 families) used ABT.<sup>233</sup> Similarly, 29 out of 40 manufacturers in MY 2022 used ABT to certify some or all of their vehicle families. Most of the manufacturers that did not use ABT produced vehicles that were certified to the optional custom chassis standards where the banking and trading components of ABT are not allowed, and averaging is limited.<sup>234</sup>

D. Vehicle Technologies and Supporting Infrastructure

For this final rule, as we did for HD Phase 1 and Phase 2, we are finalizing

more stringent CO<sub>2</sub> emissions standards for many of the regulatory subcategories and demonstrating the feasibility of those final standards based on the performance of a potential compliance pathway comprising of a package of technologies that reduce CO<sub>2</sub> emissions. And in this rule, we developed technology packages that include both vehicles with ICE and ZEV technologies. In determining which technologies to model, EPA initially considered the entire suite of technologies that we expected would be technologically feasible and commercially available to achieve significant emissions reductions, including the GHG-reducing technologies considered in the Phase 2 standards—including BEVs, FCEVs, H<sub>2</sub>-ICE vehicles, hybrid powertrains, plug-in hybrid vehicles (PHEVs), and alternative fueled-ICEVs. Because the statute requires EPA to consider lead time and costs in establishing standards, and because manufacturers (and purchasers) of HD vehicles are profit-generating enterprises that are seeking to reduce costs, EPA then identified the technologies that the record showed would be most effective at reducing CO<sub>2</sub> emissions and are cost-effective at doing so in the MYs 2027–2032 time frame, as discussed in this section II.D. As a result, EPA chose to model certain ICE vehicle technologies, BEV technologies, and FCEV technologies to support the feasibility of the final standards and for analyses for regulatory purposes, not because we have an *a priori* interest in promoting certain HD vehicle technologies over other technologies, but rather because our analysis of lead time and costs showed these are effective technologies at reducing CO<sub>2</sub> emissions and are cost-effective. The record also shows that the modeled potential compliance pathway is the lowest cost one that we assessed for manufacturers overall and would be beneficial for purchasers because the lower operating costs during the operational life of the vehicle will offset the increase in vehicle technology costs within the usual period of first ownership of the vehicle. At the same time, EPA modeled other technologies (examples of other potential compliance pathways with different mixes of technologies, as discussed in section II.F.6) recognizing that manufacturers can choose many different ways to achieve CO<sub>2</sub> emissions reductions to comply with the final performance-based standards. These additional example potential compliance pathways also support the feasibility of the final standards.

More specifically, as explained in section II.B.2, this final rule establishes new CO<sub>2</sub> emission standards for MY 2032 and later HD vehicles with more stringent CO<sub>2</sub> emission standards phasing in as early as MY 2027 for certain vehicle categories. We found that these final Phase 3 vehicle standards are appropriate and feasible, including consideration of cost of compliance and other factors, for their respective MYs and vehicle subcategories through technology improvements in several areas. To support the feasibility and appropriateness of the final standards, we evaluated each technology and estimated potential technology adoption rates of a mix of projected available technologies in each vehicle subcategory per MY (our technology packages) that EPA projects are achievable based on nationwide production volumes, considering lead time, technical feasibility, cost, and other factors. At the same time, the final standards are performance-based and do not mandate any specific technology for any manufacturer or any vehicle subcategory. In identifying the CO<sub>2</sub> standards and demonstrating the technological feasibility of such standards, we considered the statutory purpose of reducing emissions and the need for such emissions reductions, technological feasibility, costs, lead time and related factors (including safety). To evaluate and balance these statutory factors and other relevant considerations, EPA must necessarily estimate a means of compliance: what technologies can be used, what do they cost, what is appropriate lead time for their deployment, and the like. Thus, to support the feasibility of the final standards, EPA identified a modeled potential compliance pathway. Having identified one means of compliance, EPA’s task is to “answe[r] any theoretical objections” to that means of compliance, “identif[y] the major steps necessary,” and to “offe[r] plausible reasons for believing that each of those steps can be completed in the time available.” *NRDC v. EPA*, 655 F. 2d at 332. That is what EPA has done here in this final rule, and indeed what it has done in all the motor vehicle emission standard rules implementing section 202(a) of the Act. As we stated earlier in this preamble, manufacturers remain free to comply by any means they choose, including through strategies that may resemble the additional example potential compliance pathways. Based on our experience to date, it is the norm that manufacturers devise means other than those projected by EPA as a

<sup>232</sup> 40 CFR 1037.701 through 1037.750.

<sup>233</sup> U.S. EPA Heavy-Duty Vehicle Certification Data. Last accessed on January 25, 2023, at <https://www.epa.gov/compliance-and-fuel-economy-data/annual-certification-data-vehicles-engines-and-equipment>.

<sup>234</sup> See 40 CFR 1037.105(h)(2) for details. See also 40 CFR 1037.241(a) providing for individual certification of heavy-duty vehicles.



potential technology path in support of the feasibility of the standards to achieve compliance.

For each regulatory subcategory, we modeled various ICE vehicles with CO<sub>2</sub>-reducing technologies to represent the average MY 2027 vehicle that meets the MY 2027 Phase 2 standards. These vehicles are used as baselines from which to evaluate costs and effectiveness of additional technologies for each of these vehicle types and ultimately for each regulatory subcategory. The following subsections describe the GHG emission-reducing technologies for HD vehicles which EPA considered in this final rulemaking, including those for HD vehicles with ICE (section II.D.1), HD BEVs (section II.D.2), and HD FCEVs (section II.D.3), as well as a summary of the technology assessment that supports the feasibility of the final Phase 3 standards (section II.D.4) and the primary inputs we used in our technology assessment tool, Heavy-Duty Technology Resource Use Case Scenario (HD TRUCS), that we developed to evaluate the design features needed to meet the power and energy demands of various HD vehicles when using ZEV technologies, as well as costs related to manufacturing, purchasing and operating ICE vehicle and ZEV technologies used under the modeled potential compliance pathway (section II.D.5).

As previously noted, we did not propose and are not adopting changes to the existing Phase 2 GHG emission standards for HD engines. As noted in the following section and RIA Chapter 1.4, there are technologies available that can reduce GHG emissions from HD engines, and we anticipate that many of them will be used to meet the MY 2024 and MY 2027 and later Phase 2 CO<sub>2</sub> engine emission standards, while developments are underway to meet the new low NO<sub>x</sub> standards for MY 2027.<sup>235</sup> This final rule remains focused on GHG reductions through more stringent vehicle-level CO<sub>2</sub> emission standards, which will continue to account for engine CO<sub>2</sub> emissions, instead of also finalizing new CO<sub>2</sub> emission standards that apply to heavy-duty engines.

#### 1. Technologies To Reduce GHG Emissions From HD ICE Vehicles

The CO<sub>2</sub> emissions of HD vehicles vary depending on the configuration of the vehicle. Many aspects of the vehicle impact its emissions performance, including the engine, transmission, drive axle, aerodynamics, and rolling resistance.

The technologies we considered for tractors include technologies that we analyzed in Phase 2 such as improved aerodynamics; low rolling resistance tires; tire inflation systems; efficient engines, engines fueled with natural gas,

transmissions, drivetrains, and accessories; and extended idle reduction for sleeper cabs. We analyzed the overall effectiveness of the technology packages using EPA's Greenhouse Gas Emissions Model (GEM), which was used for analyzing the technology packages that support the Phase 2 vehicle CO<sub>2</sub> emission standards and is used by manufacturers to demonstrate compliance with the Phase 2 standards. EPA's GEM model simulates road load power requirements over various duty cycles to estimate the energy required per mile for HD vehicles. The inputs for the individual technologies that make up the fleet average technology package that meets the Phase 2 MY 2027 CO<sub>2</sub> tractor emission standards are shown in Table II-3.<sup>236</sup> The comparable table for vocational vehicles is shown in Table II-4.<sup>237</sup> The technology package for vocational vehicles include technologies such as low rolling resistance tires; tire inflation systems; efficient engines, transmissions, and drivetrains; weight reduction; and idle reduction technologies. Note that the HD GHG Phase 2 standards (like the Phase 1 and 3 standards) are performance-based; EPA does not require this specific technology mix, rather the technologies shown in Table II-3 and Table II-4 are potential pathways for compliance.

<sup>235</sup> 40 CFR 1036.104.

<sup>236</sup> 81 FR 73616, October 25, 2016.

<sup>237</sup> 81 FR 73714, October 25, 2016.

**Table II-3 GEM Inputs for Vehicles Meeting the Phase 2 MY 2027 Tractor CO<sub>2</sub> Emission Standards**

Class 7			Class 8					
Day Cab			Day Cab			Sleeper Cab		
Low Roof	Mid Roof	High Roof	Low Roof	Mid Roof	High Roof	Low Roof	Mid Roof	High Roof
<b>Engine Fuel Map</b>								
2027MY 11L Engine 350 HP	2027MY 11L Engine 350 HP	2027MY 11L Engine 350 HP	2027MY 15L Engine 455 HP	2027MY 15L Engine 455 HP	2027MY 15L Engine 455 HP	2027MY 15L Engine 455 HP	2027MY 15L Engine 455 HP	2027MY 15L Engine 455 HP
<b>Aerodynamics (C<sub>d</sub>A in m<sup>2</sup>)</b>								
5.12	6.21	5.67	5.12	6.21	5.67	5.08	6.21	5.26
<b>Steer Tire Rolling Resistance (CRR in kg/metric ton)</b>								
5.8	5.8	5.6	5.8	5.8	5.6	5.8	5.8	5.6
<b>Drive Tire Rolling Resistance (CRR in kg/metric ton)</b>								
6.2	6.2	5.8	6.2	6.2	5.8	6.2	6.2	5.8
<b>Extended Idle Reduction Weighted Effectiveness</b>								
N/A	N/A	N/A	N/A	N/A	N/A	3%	3%	3%
Transmission = 10 speed Manual Transmission Gear Ratios = 12.8, 9.25, 6.76, 4.90, 3.58, 2.61, 1.89, 1.38, 1.00, 0.73 Drive Axle Ratio = 3.21 for day cabs, 3.16 for sleeper cabs								
<b>6x2 Axle Weighted Effectiveness</b>								
N/A	N/A	N/A	0.6%	0.6%	0.6%	0.6%	0.6%	0.6%
Transmission Type Weighted Effectiveness = 1.6%								
<b>Neutral Idle Weighted Effectiveness</b>								
0.2%	0.2%	0.2%	0.2%	0.2%	0.2%	0.03%	0.03%	0.03%
Direct Drive Weighted Effectiveness = 1.0%								
Transmission Efficiency Weighted Effectiveness = 0.7%								
Axle Efficiency Improvement = 1.6%								
Air Conditioner Efficiency Improvements = 0.3%								
Accessory Improvements = 0.2%								
Predictive Cruise Control = 0.8%								
Automatic Tire Inflation Systems = 0.4%								
Tire Pressure Monitoring System = 0.7%								

**Table II-4 GEM Inputs for Vehicles Meeting the Phase 2 MY 2027 Vocational Vehicle CO<sub>2</sub> Emission Standards**

LHD (Class 2b-5)			MHD (Class 6-7)			HHD (Class 8)		
Urban	Multi-Purpose	Regional	Urban	Multi-Purpose	Regional	Urban	Multi-Purpose	Regional
<b>SI Engine Fuel Map</b>								
2018 MY 6.8L, 300 hp engine								
<b>CI Engine Fuel Map</b>								
2027 MY 7L, 200 hp Engine			2027 MY 7L, 270 hp Engine			2027 MY 11L, 350 hp Engine		2027 MY 11L, 350 hp Engine and 2027 MY 15L 455hp Engine
<b>Torque Converter Lockup in 1<sup>st</sup> Gear (adoption rate)</b>								
50%	50%	50%	50%	50%	50%	30%	30%	0%
<b>6x2 Disconnect Axle (adoption rate)</b>								
0%	0%	0%	0%	0%	0%	0%	25%	30%
<b>Automatic Engine Shutdown (adoption rate)</b>								
70%	70%	90%	70%	70%	90%	70%	70%	90%
<b>Stop-Start (adoption rate)</b>								
30%	30%	0%	30%	30%	0%	20%	20%	0%
<b>Neutral Idle (adoption rate)</b>								
60%	60%	0%	60%	60%	0%	70%	70%	0%
<b>Steer Tire Rolling Resistance (CRR kg/metric ton)</b>								
6.8	6.2	6.2	6.7	6.2	6.2	6.2	6.2	6.2
<b>Drive Tire Rolling Resistance (CRR kg/metric ton)</b>								
6.9	6.9	6.9	7.5	6.9	6.9	7.5	6.9	6.9
<b>Weight Reduction (pounds)</b>								
75	75	75	75	75	75	125	125	125

Technologies exist today and continue to evolve to improve the efficiency of the engine, transmission, drivetrain, aerodynamics, and tire rolling resistance in HD vehicles and therefore reduce their CO<sub>2</sub> emissions. As discussed in the preamble to the HD GHG Phase 2 program and shown here in Table II-3 and Table II-4, there are a variety of such technologies. In developing the Phase 2 CO<sub>2</sub> emission standards, we developed technology packages that were premised on a mix of projected technologies and potential technology adoption rates of less than 100 percent. As discussed in section II.F.4 under the additional example potential compliance pathways, there is an opportunity for further improvements and increased adoption through MY 2032 for many of these technologies. Furthermore, as discussed in section II.F.4 under the additional example potential compliance pathways, we also considered additional technologies than those in the Phase 2 MY 2027 technology packages such as H2-ICE, hybrids, and natural gas engines. Each of these technologies is discussed in this section and RIA Chapter 1.4.

i. Aerodynamics

For example, we evaluated the potential for additional GHG performance gains from aerodynamic improvements. Up to 25 percent of the fuel consumed by a sleeper cab tractor traveling at highway speeds is used to overcome aerodynamic drag forces, making aerodynamic drag a significant contributor to a Class 7 or 8 tractor's GHG emissions and fuel consumption.<sup>238</sup> Because aerodynamic drag varies by the square of the vehicle speed, small changes in the tractor aerodynamics can have a large impact on the GHG emissions of a tractor. With much of their driving at highway speed, the GHG emission reductions of reduced aerodynamic drag for Class 7 or 8 tractors can be significant.<sup>239</sup>

Improving the vehicle shape may include revising the fore components of the vehicle such as rearward canting/raking or smoothing/rounding the edges of the front-end components (e.g.,

bumper, headlights, windshield, hood, cab, mirrors) or integrating the components at key interfaces (e.g., windshield/glass to sheet metal) to alleviate fore vehicle drag. Finally, improvements may include redirecting the air to prevent areas of low pressure and slow-moving air (thus, eliminating areas where air builds creating turbulent vortices and increasing drag). Techniques such as blocking gaps in the sheet metal, ducting of components, shaping or extending sheet metal to reduce flow separation and turbulence are methods being considered by manufacturers to direct air from areas of high drag (e.g., underbody and tractor-trailer gap).

As discussed in the Phase 2 RIA, the National Research Council of Canada performed an assessment of the aerodynamic drag effect of various tractor components.<sup>240</sup> Based on the results, there is the potential to improve tractor aerodynamics by 0.206 wind averaged coefficient of drag area (CdA) with the addition of wheel covers, drive

<sup>238</sup> Assumes travel on level road at 65 miles per hour. (21st Century Truck Partnership Roadmap and Technical White Papers, December 2006. U.S. Department of Energy, Energy Efficiency and Renewable Energy Program. 21CTP-003. p.36.

<sup>239</sup> Reducing Heavy-Duty Long Haul Combination Truck Fuel Consumption and CO<sub>2</sub> Emissions, ICCT, October 2009.

<sup>240</sup> Jason Leuschen and Kevin R. Cooper (National Research Council of Canada), Society of Automotive Engineer. (SAE) Paper #2006-01-3456: "Full-Scale Wind Tunnel Tests of Production and Prototype, Second-Generation Aerodynamic Drag-Reducing Devices for Tractor-Trailers." November 2, 2006.

axle wrap around splash guards, and roof fairing rear edge filler. Up to 0.460 CdA improvement is possible if the side and fender mirrors are replaced with a camera system, as suggested by the study, and combined with the wheel covers, drive axle wrap around splash guards, and roof fairing rear edge filler.

In our Phase 2 analysis, considering the wind average drag performance of heavy-duty tractors at the time, this study demonstrated the possibility to improve tractors an additional ~1 percent with some simple changes.

In Phase 2, the tractor aerodynamic performance was evaluated using the wind averaged coefficient of drag area

results measured during aerodynamic testing as prescribed in 40 CFR 1037.525. The results of the aerodynamic testing are used to determine the aerodynamic bin and CdA input value for GEM, as prescribed in 40 CFR 1037.520 and shown in Table II-5.

**Table II-5 GEM Inputs for Tractor Aerodynamic Bins (CdA in m<sup>2</sup>)**

	Class 7			Class 8					
	Day Cab			Day Cab			Sleeper Cab		
	Low Roof	Mid Roof	High Roof	Low Roof	Mid Roof	High Roof	Low Roof	Mid Roof	High Roof
Bin I	6.00	7.00	7.45	6.00	7.00	7.45	6.00	7.00	7.15
Bin II	5.60	6.65	6.85	5.60	6.65	6.85	5.60	6.65	6.55
Bin III	5.15	6.25	6.25	5.15	6.25	6.25	5.15	6.25	5.95
Bin IV	4.75	5.85	5.70	4.75	5.85	5.70	4.75	5.85	5.40
Bin V	4.40	5.50	5.20	4.40	5.50	5.20	4.40	5.50	4.90
Bin VI	4.10	5.20	4.70	4.10	5.20	4.70	4.10	5.20	4.40
Bin VII	3.80	4.90	4.20	3.80	4.90	4.20	3.80	4.90	3.90

EPA conducted aerodynamic testing for the Phase 2 final rule.<sup>241</sup> As shown in Phase 2 RIA Chapter 3.2.1.2, the most aerodynamic high roof sleeper cabs tested had a CdA of approximately 5.4 m<sup>2</sup>, which is a Bin IV tractor. Therefore, we concluded that prior to 2016 manufacturers were producing high roof sleeper cabs that range in aerodynamic performance between Bins I and IV. Bin V is achievable through the addition of aerodynamic features that improve the aerodynamics on the best pre-2016 sleeper cabs tested by at least 0.3 m<sup>2</sup> CdA. The features that could be added include technologies such as wheel covers, drive axle wrap around splash guards, and roof fairing rear edge filler, and active grill shutters. In addition, manufacturers continue to improve the aerodynamic designs of the front bumper, grill, hood, and windshield.

Our analysis of high roof day cabs is similar to our assessment of high roof sleeper cabs. Also, as shown in Phase 2 RIA Chapter 3.2.1.2, the most aerodynamic high roof day cab tested by EPA achieved Bin IV. Our assessment is that the same types of additional technologies that could be applied to high roof sleeper cabs could also be applied to high roof day cabs to achieve Bin V aerodynamic performance. Finally, because the manufacturers have the ability to determine the

aerodynamic bin of low and mid roof tractors from the equivalent high roof tractor, this assessment also applies to low and mid roof tractors.

For our modeled potential compliance pathway in Phase 3 tractors' technology packages, the vehicles with ICE portion of the technology package for the MY 2027 high roof sleeper cab tractor includes 20 percent Bin III, 30 percent Bin IV, and 50 percent Bin V reflecting our assessment of the fraction of high roof sleeper cab tractors. We continue to project, as we projected in the Phase 2 rulemaking, that manufacturers could successfully apply these aerodynamic packages by MY 2027. The weighted average for tractors of this set of adoption rates is equivalent to a tractor aerodynamic performance near the border between Bin IV and Bin V.

The Phase 2 standards for vocational vehicles were not projected to be met with the use of aerodynamic improvements.

ii. Tire Rolling Resistance

Energy loss associated with tires is mainly due to deformation of the tires under the load of the vehicle, known as hysteresis, but smaller losses result from aerodynamic drag, and other friction forces between the tire and road surface and the tire and wheel rim. Collectively the forces that result in energy loss from the tires are referred to as rolling resistance. Tires with higher rolling resistance lose more energy, thus using more fuel and producing more CO<sub>2</sub> emissions in operation, while tires with

lower rolling resistance lose less energy, and use less fuel, producing less CO<sub>2</sub> emissions in operation.

A tire's rolling resistance is a factor considered in the design of the tire and is affected by the tread and casing compound materials, the architecture of the casing, tread design, and the tire manufacturing process. It is estimated that 35 to 50 percent of a tire's rolling resistance is from the tread and the other 50 to 65 percent is from the casing.<sup>242</sup> Tire inflation can also impact rolling resistance in that under-inflated tires can result in increased deformation and contact with the road surface.

In Phase 2, we developed four levels of tire rolling resistance, as shown in Table II-6. The levels included the baseline (average) from 2010, Level 1 and Level 2 from Phase 1, and Level 3 that achieves an additional 25 percent improvement over Level 2. The Level 2 threshold represents an incremental step for improvements beyond today's SmartWay level and represents the best in class rolling resistance of the tires we tested for Phase 1.<sup>243</sup> The Level 3 values represented the long-term rolling resistance value that EPA projected could be achieved in the MY 2025 timeframe. Given the multiple year phase-in of the Phase 2 standards, EPA

<sup>241</sup> U.S. EPA. Regulatory Impact Analysis Greenhouse Gas Emissions and Fuel Efficiency Standards for Medium- and Heavy-Duty Engines and Vehicles—Phase 2. Chapter 3. EPA-420-R-16-900. August 2016.

<sup>242</sup> "Tires & Truck Fuel Economy," A New Perspective. Bridgestone Firestone, North American Tire, LLC, Special Edition Four, 2008. EPA-HQ-OAR-2010-0162-0373.

<sup>243</sup> U.S. EPA. SmartWay Verified Low Rolling Resistance Tires Performance Requirements. Available online: <https://www.epa.gov/sites/default/files/2016-02/documents/420f12024.pdf>.

expected that tire manufacturers will continue to respond to demand for more efficient tires and will offer increasing

numbers of tire models with rolling resistance values significantly better

than the typical low rolling resistance tires offered in 2016.

**Table II-6 Phase 2 Tire Rolling Resistance Technologies**

	Class 7			Class 8					
	Day Cab			Day Cab			Sleeper Cab		
	Low Roof	Mid Roof	High Roof	Low Roof	Mid Roof	High Roof	Low Roof	Mid Roof	High Roof
<b>Steer Tires (CRR in kg/metric ton)</b>									
Base	7.8	7.8	7.8	7.8	7.8	7.8	7.8	7.8	7.8
Level 1	6.6	6.6	6.6	6.6	6.6	6.6	6.6	6.6	6.6
Level 2	5.7	5.7	5.7	5.7	5.7	5.7	5.7	5.7	5.7
Level 3	4.9	4.9	4.9	4.9	4.9	4.9	4.9	4.9	4.9
<b>Drive Tires (CRR in kg/metric ton)</b>									
Base	8.1	8.1	8.1	8.1	8.1	8.1	8.1	8.1	8.1
Level 1	6.9	6.9	6.9	6.9	6.9	6.9	6.9	6.9	6.9
Level 2	6.0	6.0	6.0	6.0	6.0	6.0	6.0	6.0	6.0
Level 3	5.0	5.0	5.0	5.0	5.0	5.0	5.0	5.0	5.0

In the modeled compliance pathway for the Phase 3 tractors' technology packages, the vehicles with ICE portion of the technology package for the MY 2027 included steer and drive tires that on average performed at a Level 2 rolling resistance. We continue to project, as we projected in the Phase 2 rulemaking, that manufacturers could successfully apply tires that on average perform at this level by MY 2027.

iii. Natural Gas Engines

Natural-gas powered heavy-duty vehicles are very similar to gasoline and diesel fueled ICE-powered vehicles. The engine functions the same as a gasoline or diesel fueled ICE. Two key differences are the fuel storage and delivery systems. The fuel delivery system delivers high-pressure natural gas from the fuel tank to the fuel injectors located on the engine. Similar to gasoline or diesel fuel, natural gas is stored in a fuel tank, or cylinder, but requires the ability to store the fuel under high pressure.

There are different ways that heavy-duty engines can be configured to use natural gas as a fuel. The first is a spark-ignition natural gas engine. An Otto cycle SI heavy-duty engine uses a spark plug for ignition and burns the fuel stoichiometrically. Due to this, the engine-out emissions require use of a three-way catalyst to control criteria pollutant emissions. The second is a direct injection natural gas that utilizes a compression-ignition (CI) cycle. The CI engine uses a small quantity of diesel fuel (pilot injection) as an ignition source along with a high compression

ratio engine design. The engine operates lean of stoichiometric operation, which leads to engine-out emissions that require aftertreatment systems similar to diesel ICEs, such as diesel oxidation catalysts, selective catalytic reduction systems, and diesel particulate filters. The CNG CI engine is more costly than a diesel CI engine because of the special natural gas/diesel fuel injection system. The NG SI engine and aftertreatment system is less costly than a NG CI engine and aftertreatment system but is less fuel efficient than a NG CI engine because of the lower compression ratio.

In addition to differences in engine architecture, the natural gas fuel can be stored two ways—compressed (CNG) or liquified (LNG). A CNG tank stores pressurized gaseous natural gas and the system includes a pressure regulator. An LNG tank stores liquified natural gas that is cryogenically cooled but stored at a lower pressure than CNG. The LNG tanks often are double walled to help maintain the temperature of the fuel, and include a gasification system to turn the fuel from a liquid to a gas before injecting the fuel into the engine. An important advantage of LNG is the increased energy density compared to CNG. Because of its higher energy density, LNG can be more suitable for applications such as long-haul applications.

Natural gas engines are a mature technology. Cummins manufactures natural gas engines that cover the complete range of heavy-duty vehicle applications, with engine displacements ranging from 6.7L to 12L. Heavy-duty CNG and LNG vehicles are available

today in the fleet. EIA estimates that approximately 4,400 CNG and LNG heavy-duty vehicles were sold in 2022 and approximately 50,000 CNG and LNG vehicles are in the U.S. heavy-duty fleet.<sup>244</sup> Manufacturers are producing CNG and LNG vehicles in all of the vocational and tractor categories, especially buses, refuse hauler, street sweeper, and tractor applications, as discussed further in RIA Chapter 1.4.1.2.<sup>245</sup>

iv. Hydrogen-Fueled Internal Combustion Engines

Currently, hydrogen fueled internal combustion engines (H2-ICE) are in the demonstration stage. H2-ICE is a technology that provides nearly zero tailpipe emissions for hydrocarbons, carbon monoxide, and carbon dioxide. H2-ICE require less exhaust aftertreatment. These systems may not require the diesel particulate filter (DPF). However, NO<sub>x</sub> emissions are still formed during the H2-ICE combustion process and therefore a selective catalytic reduction (SCR) system would be required, as well a diesel oxidation catalyst, though it may be smaller in size than that used in a comparable diesel-fueled ICE. The use of lean air-

<sup>244</sup> EIA. Annual Energy Outlook 2023. Table 49. Available Online: <https://www.eia.gov/outlooks/aeo/data/browser/#/?id=58-AEO2023&cases=ref2023&sourcekey=0>.

<sup>245</sup> Department of Energy Alternative Fuels Data Center. Available Online: [https://afdc.energy.gov/vehicles/search/results?manufacturer\\_id=67,205,117,394,415,201,113,5,408,481,9,13,11,458,81,435,474,57,416,141,197,417,121,475,53,397,418,85,414,17,21,143,476,492,23,484,398,27,477,399,31,207,396,489,107,465,487,193,460,35,459,115,37,147,480,199](https://afdc.energy.gov/vehicles/search/results?manufacturer_id=67,205,117,394,415,201,113,5,408,481,9,13,11,458,81,435,474,57,416,141,197,417,121,475,53,397,418,85,414,17,21,143,476,492,23,484,398,27,477,399,31,207,396,489,107,465,487,193,460,35,459,115,37,147,480,199).

fuel ratios, and not exhaust gas recirculation (EGR), is the most effective way to control NO<sub>x</sub> in a H2-ICE, as EGR is less effective with H2 due to the absence of CO<sub>2</sub> in the exhaust gas.

H2-ICE can be developed using an OEM's existing tooling, manufacturing processes, and engine design expertise. H2-ICE engines are very similar to existing ICEs and can leverage the extensive technical expertise manufacturers have developed with existing products. Similarly, H2-ICE products can be built on the same assembly lines as other ICE vehicles, by the same workers and with many of the same component suppliers.

H2-ICE incorporate several differences from their diesel baseline. Components such as the cylinder head, valves, seals, piston, and piston rings would be unique to the H2-ICE to control H2 leakage during engine operation. Another difference between a diesel-fueled ICE and a H2-ICE is the fuel storage tanks. The hydrogen storage tanks are more expensive than today's diesel fuel tanks. The fuel tanks likely to be used by H2-ICE are identical to those used by a fuel cell electric vehicle (FCEV) and they may utilize either compressed storage (350 or 700 Bar pressure) or cryogenic storage (temperatures as low as -253 Celsius). Please refer to Chapter 1.7.2 of this document for the discussion regarding H2 fuel storage tanks.

H2-ICE may hasten the development of hydrogen infrastructure because they do not require as pure of hydrogen as FCEVs. Hydrogen infrastructure exists in limited quantities in some parts of the country for applications such as forklifts, buses, and LDVs and HDVs at ports. Federal funds are being used to support the development of additional hubs and other hydrogen related infrastructure items through the BIL and IRA, as described in more detail in Chapter 1.8.

Since neat hydrogen fuel does not contain any carbon, H2-ICE fueled with neat hydrogen produce zero HC, CH<sub>4</sub>, CO, and CO<sub>2</sub> engine-out emissions.<sup>246</sup> However, as explained in section III.C.2.xviii, we recognize that, like CI ICE, there may be negligible, but non-zero, CO<sub>2</sub> exhaust emissions of H2-ICE that use SCR and are fueled with neat hydrogen due to contributions from the aftertreatment system from urea decomposition. Thus, for purposes of compliance with engine CO<sub>2</sub> exhaust emission standards under 40 CFR part 1036, we are finalizing an engine testing

default CO<sub>2</sub> emission value (3 g/hp-hr) option (though manufacturers may instead conduct testing to demonstrate that the CO<sub>2</sub> emissions for their engine is below 3 g/hp-hr). Under our existing fuel-mapping test procedures that may be used as part of demonstrating compliance with vehicle CO<sub>2</sub> exhaust emission standards, the results are fuel consumption values and therefore the CO<sub>2</sub> emissions from urea decomposition are not included in the results.<sup>247 248</sup> Under this final rule, consistent with existing treatment of such contributions from the aftertreatment system from urea decomposition (e.g., for diesel ICE vehicles) for compliance with vehicle CO<sub>2</sub> exhaust emission standards, we are not including such contributions in determining compliance with vehicle CO<sub>2</sub> exhaust emission standards for H2-ICE vehicles. Thus, H2-ICE technologies that run on neat hydrogen, as defined in 40 CFR 1037.150(f) and discussed in section III.C.3.ii of the preamble, have HD vehicle CO<sub>2</sub> emissions that are deemed to be zero for purposes of compliance with vehicle emission standards under 40 CFR part 1037. Therefore, the technology effectiveness (in other words CO<sub>2</sub> emission reduction) for the vehicles that are powered by this technology is 100 percent for compliance with vehicle CO<sub>2</sub> exhaust emission standards.

v. Hybrid and Plug-In Hybrid Powertrains

The heavy-duty industry has also been developing hybrid powertrains, as described in RIA Chapter 1.4.1.1. Hybrid powertrains consist of an ICE as well as an electric drivetrain. The ICE uses a consumable fuel (e.g., diesel) to produce power which can either propel the vehicle directly or charge the traction battery from which the electric motor draws its energy. These two sources of power can be used in combination to do work and move the vehicle, or they may operate individually, switching between the two sources. Plug-in hybrid electric vehicles (PHEVs) are a combination of ICE and electric vehicles, so they have an ICE and a battery, an electric motor, and a fuel tank, and plug-in to the electric grid to recharge the battery. PHEVs use both gasoline or diesel and electricity as fuel sources.

<sup>247</sup> See 81 FR 73552 (October 25, 2016), for the explanation on why CO<sub>2</sub> from urea decomposition is included when showing compliance with the engine standards and it is not included when showing compliance with the vehicle CO<sub>2</sub> standards.

<sup>248</sup> See, e.g., 40 CFR 1037.501 (including reference to 40 CFR 1036.535, 1036.540, and 1036.545).

Hybrid powered vehicles can provide CO<sub>2</sub> emission reductions from splitting or blending of ICE and electric operation. Hybrid vehicles reduce CO<sub>2</sub> emissions through four primary mechanisms:

- In a series hybrid powertrain, the ICE operates as a generator to create electricity for the battery. Series hybrids can be optimized through downsizing, modifying the operating cycle, or other control techniques to operate at or near its most efficient engine speed-load conditions more often than is possible with a conventional engine-transmission driveline. Power loss due to engine downsizing can be mitigated by employing power assist from the secondary, electric driveline.

- Hybrid vehicles typically include regenerative braking systems that capture some of the energy normally lost while braking and store it in the traction battery for later use. That stored energy is typically used to provide additional torque upon initial acceleration from stop or additional power for moving the vehicle up a steep incline.

- Hybrid powertrains allow the engine to be turned off when it is not needed, such as when the vehicle is coasting or when the vehicle is stopped. Furthermore, some vehicle systems such as cabin comfort and power steering can be electrified if a 48V or higher battery system is incorporated into the vehicle. The electrical systems are more efficient than their conventional counterparts which utilize an accessory drive belt on a running engine. When the engine is stopped these accessory loads are supported by the traction battery.

- Plug-in hybrid vehicles can further reduce CO<sub>2</sub> emissions by increasing the battery storage capacity and adding the ability to connect to the electrical power grid to fully charge the battery when the vehicle is not in service, which can significantly expand the amount of all-electric operation.

Hybrid vehicles can utilize a combination of some or all of these mechanisms to reduce fuel consumption and CO<sub>2</sub> emissions. The magnitude of the CO<sub>2</sub> reduction achieved depends on the utilization/optimization of the previously listed mechanisms and the powertrain design decisions made by the manufacturer.

Hybrid technology is well established in the U.S. light-duty market, where some manufacturers have been producing light-duty hybrid models for several decades and others are looking to develop hybrid models in the future. Hybrid powertrains are available today in a number of heavy-duty vocational vehicles including passenger van/

<sup>246</sup> Note, NO<sub>x</sub> and PM emission testing is required under existing 40 CFR part 1036 for engines fueled with neat hydrogen.

shuttle bus, transit bus, street sweeper, refuse hauler, and delivery truck applications. Hybrid transit buses have been purchased for use in cities including Philadelphia, PA, and Toronto, Canada. Heavy-duty hybrid vehicles may include a power takeoff (PTO) system that is used to operate auxiliary equipment, such as the boom/bucket on a utility truck or the water pump on a fire truck. Utility trucks with electric PTOs where the electricity to power the auxiliary equipment can be provided by the battery have been sold.

Plug-in hybrid electric vehicles run on both electricity and fuel. Many PHEV models are available today in the light-duty market.<sup>249</sup> Today there is a limited number of PHEV heavy-duty models. Light-duty manufacturers that also produce heavy-duty vehicle could bring PHEVs to market in the LHD and MHD segments in less time than for the HHD and tractor segments. The utility factor is the fraction of miles the vehicle travels in electric mode relative to the total miles traveled. The percent CO<sub>2</sub> emission reduction is directly related to the utility factor. The greater the utility factor, the lower the tailpipe CO<sub>2</sub> emissions from the vehicle. The utility factor depends on the size of the battery and the operator's driving habits.

vi. ICE Vehicle Technologies in the Modeled Potential Compliance Pathway

We received a number of comments on technologies to reduce CO<sub>2</sub> emissions from ICE vehicles. One commenter indicated that vehicle improvements to ICE vehicles would be cost-effective and could lead to appreciable further reductions from ICE vehicles. Specifically, the commenter pointed to improvements of nearly 7 percent for vehicle improvements to high-roof sleeper cabs (aerodynamic improvements, tires, intelligent controls, weight reduction, axle efficiency, reduced accessory load); nearly 10 percent for vehicle improvements for multi-purpose vocational vehicles (stop-start, weight reduction, tires, axle efficiency, aerodynamic improvements, reduced accessory load); improvements from 6–12 percent from vehicle improvements to Class 7 and 8 tractors; and from 15–20 percent for vehicle improvements for vocational vehicles (all percentages reflecting incremental improvements beyond the MY 2027 Phase 2 standard). Further improvements are posited by the commenter if engine improvements

are considered. Another commenter echoed those comments, urging that the standards reflect further improvements for ICE vehicles. Acknowledging that these improvements could be viewed as a different compliance pathway to meet the proposed standards (which is consistent with the proposal and final rule explaining the Phase 3 standards are performance-based standards), the commenter urged that these improvements be incremental to any improvements predicated on a ZEV technology package. A third commenter also supported the first commenter's assessment of engine and vehicle technologies and further cited a separate comment submitted to EPA that cylinder deactivation used as active thermal management also improves efficiency.

On the other hand, several HD vehicle manufacturers noted that some ICE vehicle technologies have lagged behind projections made by EPA to support the Phase 2 rule. These technologies include automatic tire inflation systems, electric accessories, and tamper proof idle reduction for vocational vehicles, stop-start technologies, and advanced transmission shifting strategies. Some of the reasons include lack of technology availability (e.g., engine stop-start), technology costs (e.g., auto tire inflation, electric accessories), customer adoption willingness (e.g., one-minute idle shutdown timers), and high compliance costs (e.g., powertrain testing).

For the final rule analysis, we evaluated the manufacturers' compliance with the MY 2021 standards (the first year of Phase 2). While the manufacturers note in comments that they are not seeing the adoption of certain engine and vehicle technologies at the rates shown in EPA's technology package to support the Phase 2 rule, this does not mean that the technologies EPA expected are not available; it just means manufacturers have found different ways to comply. In addition, we are still several years away from the MY 2027 vehicle production so there continues to be time for increased adoption of these technologies. Furthermore, EPA's emission standards are performance-based and manufacturers will use a number of different technologies to comply. These include all those listed in the Phase 2 package for MY 2027 because they are being installed on vehicles today, hybrids including PHEVs, and alternative fueled vehicles such as natural gas, as suggested by commenters. We are thus not convinced that these technologies are not available for Phase 3 consistent with the potential

compliance pathway we projected in Phase 2 and currently project.

For the ICE vehicle technologies part of the analysis that supports the feasibility of the Phase 3 standards, our assessment is that technology packages developed for the Phase 2 rule are still appropriate for use in this final rule and thus the technology packages for the potential compliance pathway include a mix of ICE vehicle technologies and adoption rates of those technologies at the levels included in the Phase 2 MY 2027 technology packages. We also developed other additional potential compliance pathways, with different technology packages, to support the feasibility of the Phase 3 final standards that are based on vehicles with ICE technologies. See section II.F.4 of this preamble. These example compliance pathways include consideration of potential different pathways to compliance through the use of such ICE vehicle technologies beyond those included in the Phase 2 MY 2027 technology packages, plus technologies such as H<sub>2</sub>-ICE, plug-in hybrids, and natural gas engines. Additional discussion can be found in section 9.2 of the RTC.

2. HD Battery Electric Vehicle Technology and Infrastructure

In addition to assessing ICE technologies, EPA also assessed BEV technologies, which we anticipate will be widely available for many HD vehicle applications during the timeframe for this rule and which have the potential to achieve very large CO<sub>2</sub> emissions reductions. Our assessment of feasibility of the Phase 3 standards includes not only an assessment of the performance of projected potential emissions control technologies, but also the availability of this technology within the rule's timeframe. Our assessment of technology availability includes evaluating the availability of critical minerals for such technologies (including issues associated with supply chain readiness) and the readiness of sufficient supporting electrical infrastructure. The following subsections address each of these elements.

The HD BEV market has been growing significantly since MY 2018. RIA Chapter 1.5 includes BEV vehicle information on over 160 models produced by over 60 manufacturers that cover a broad range of applications, including school buses, transit buses, straight trucks, refuse haulers, vans, tractors, utility trucks, and others, available to the public through MY 2024. Others project significant growth

<sup>249</sup> US Department of Energy. Fueleconomy.gov. Available online: <https://fueleconomy.gov/feg/PowerSearch.do?action=alts&path=3&year=2024&vtype=Plug-in+Hybrid&srchtyp=year&vrowLimit=50&pageno=1>.

of ZEV sales to continue into the future, achieving 50 percent by 2035.<sup>250</sup>

i. Batteries Design Parameters

The battery electric propulsion system includes a battery pack that provides the energy to the motor that moves the vehicle. In this section, and in RIA Chapter 1.5.1 and 2.4, we discuss battery technology that can be found in both BEVs and FCEVs.

Battery design involves considerations related to cost<sup>251</sup> and performance including specific energy<sup>252</sup> and energy density,<sup>253</sup> temperature impact, durability, and safety. These parameters typically vary based on the cathode and anode materials, and on the conductive electrolyte medium at the cell level. Different battery chemistries have different intrinsic values. Here we provide a brief overview of the different energy and power parameters of batteries and battery chemistries.

a. Battery Energy and Power Parameters

Specific energy and power and energy density are a function of how much energy or power can be stored per unit mass (in Watt-hour per kilogram (Wh/kg) or Watt per kilogram (W/kg)) or volume (in Watt-hour per liter (Wh/L)). Therefore, for a given battery weight or mass, the energy (in kilowatt-hour or kWh) can be calculated. For example, a battery with high specific energy and a lower weight may yield the same amount of energy as a chemistry with a lower specific energy and more weight.

Battery packs have a “nested” design where a group of cells are combined to make a battery module and a group of modules are combined to make a battery pack. Therefore, the battery systems can be described on the pack, module, and cell levels. Common battery chemistries today include lithium-ion based cathode chemistries, such as nickel-manganese-cobalt (NMC), nickel-cobalt-aluminum (NCA), and iron-phosphate (LFP).

<sup>250</sup> Truckinginfo.com “ACT: Half of Class 4–8 Sales to be BEV by 2035.” February 2022. Available online: <https://www.truckinginfo.com/10161524/act-half-of-class-4-8-sales-to-be-bev-by-2035>.

<sup>251</sup> Cost here is associated with cost of the battery design. This cost may be associated with using more expensive minerals (e.g., nickel and cobalt instead of iron phosphate). Alternatively, some battery cell components may be more expensive for the same chemistry. For example, power battery cells are more expensive to manufacture than energy battery cells because these cells require thinner electrodes which are more complex to produce.

<sup>252</sup> Battery specific energy (also referred to as gravimetric energy density) is a measure of battery energy per unit of mass.

<sup>253</sup> Volumetric energy density (also called energy density) is a measure of battery energy per unit of volume.

Nickel-based chemistries typically have higher gravimetric and volumetric energy densities than iron phosphate-based chemistries. Since energy or power is only housed at the chemistry level, any additional mass such as the cell, module, and pack casings will only add to the weight of the battery without increasing the energy of the overall system. Therefore, some pack producers have eliminated the module in favor of a “cell-to-pack” design in recent years.<sup>254</sup>

External factors, especially temperature, can have a strong influence on the performance of the battery. Like all BEVs, heavy-duty BEVs today include thermal management systems to keep the battery operating within a desired temperature range, which is commonly referred to as conditioning of the battery. Therefore, while operating a vehicle in cold temperatures, some of the battery energy is used to heat both the battery packs and the vehicle interior.<sup>255</sup> Cold temperatures, in particular, can result in reduced mobility of the lithium ions in the liquid electrolyte inside the battery; for the driver, this may mean lower range. Battery thermal management is also used during hot ambient temperatures to keep the battery from overheating. We consider and account for the energy required for battery thermal management in our analysis, as discussed in section II.D.5.ii.b.

b. Battery Durability

Another important battery design consideration is the durability of the battery. Durability is frequently associated with cycle life, where cycle life is the number of times a battery can fully charge and discharge before the battery capacity falls below the minimum design capacity.<sup>256</sup> In 2015 the United Nations Economic Commission for Europe (UN ECE) began studying the need for a Global Technical Regulation (GTR) governing battery durability in light-duty vehicles. In 2021 it finalized United Nations Global Technical Regulation No. 22, “In-Vehicle Battery Durability for Electrified Vehicles,”<sup>257</sup> or GTR No. 22, which

<sup>254</sup> BYD “blade” cells are an example of cell-to-pack technology.

<sup>255</sup> <https://www.aaa.com/AAA/common/AAR/files/AAA-Electric-Vehicle-Range-Testing-Report.pdf>.

<sup>256</sup> The minimum design capacity is typically defined as the point where the usable battery energy (UBE) is less than 70 or 80 percent of the UBE of a new battery.

<sup>257</sup> United Nations Economic Commission for Europe, Addendum 22: United Nations Global Technical Regulation No. 22, United Nations Global Technical Regulation on In-vehicle Battery Durability for Electrified Vehicles, April 14, 2022.

provides a regulatory structure for contracting parties to set standards for battery durability in light-duty BEVs and PHEVs. Likewise, although not finalized, the UN ECE GTR working group began drafting language for HD BEVs and hybrid electric vehicles. Loss of electric range can lead to a loss of utility, meaning electric vehicles can be driven less and therefore displace less distance travelled than might otherwise be driven in ICE vehicles. Furthermore, a loss in utility can dampen purchaser sentiment.

For batteries that are used in HD BEVs, the state of health (SOH) is an important design factor. The performance of electrified vehicles may be affected by excess degradation of the battery system over time, thus reducing the range of the vehicle. However, the durability of a battery is not limited to the cycling of a battery; there are many phenomena that can impact the duration of usability of a battery. As a battery goes through charge and discharge cycles, the SOH of the battery decreases. Capacity fade, increase in internal resistance, and voltage loss, for example, are other common metrics to measure the SOH of a battery. These parameters together help better understand and define the longevity or durability of the battery. The SOH and, in turn, the cycle life of the battery are determined by both the chemistry of the battery and external factors including temperature. The rate at which the battery is discharged as well as the rate at which it is charged will also impact the SOH of the battery. Lastly, calendar aging, or degradation of the battery while not in use, can also contribute to the deterioration of the battery.

There are several ways to improve and prolong the battery life in a vehicle. In our assessment, we account for maintaining the battery temperature while driving by applying additional energy required for conditioning the battery. See section II.D.5 of this preamble.

c. HD BEV Safety Assessment

HD BEV systems must be designed to always maintain safe operation. As with any on-road vehicle, BEVs must be robust while operating in temperature extremes as well as in rain and snow. The BEV systems must be designed for reasonable levels of immersion, including immersion in salt water or brackish water. BEV systems must also be designed to be crashworthy and limit damage that compromises safety. If the structure is compromised by a severe

Available at: [https://unece.org/sites/default/files/202204/ECE\\_TRANS\\_180a22e.pdf](https://unece.org/sites/default/files/202204/ECE_TRANS_180a22e.pdf).



impact, the systems must provide first responders with a way to safely conduct their work at an accident scene. The HD BEV systems must be designed to ensure the safety of users, occupants, and the general public in their vicinity.

In RIA Chapter 1.5.2, we discuss the industry codes and standards used by manufacturers that guide safe design and development of heavy-duty BEVs, including those for developing battery systems and charging systems that protect people and the equipment. These standards have already been developed by the industry and are in place for manufacturers to use to develop current and future products. The standards guide the design of BEV batteries to allow them to safely accept and deliver power for the life of the vehicle. The standards provide guidance to design batteries that also handle vibration, temperature extremes, temperature cycling, water, and mechanical impact from items such as road debris. For HD BEVs to uphold battery/electrical safety during and after a crash, they are designed to maintain high voltage isolation, prevent leakage of electrolyte and volatile gases, maintain internal battery integrity, and withstand external fire that can come from the BEV or other vehicle(s) involved in a crash. NHTSA continues work on battery safety requirements in FMVSS No. 305 to extend its applicability to HD vehicles, aligning it with the existing Global Technical Regulation (GTR) No. 20, and including safety requirements during normal operation, charging, and post-crash.

We requested comment on our assessment at proposal that HD BEV systems must be, and are, designed “to always maintain safe operation.” 88 FR 25962. Some commenters supported our assessment that there are industry codes and standards for the safe design and operation of HD BEVs. In addition, some commenters highlighted that HD BEVs are subject to, and necessarily comply with, the same Federal safety standards and the same safety testing as ICE heavy-duty vehicles. Commenters challenging the safety of HD BEVs failed to address the existence of these protocols and Federal standards. While considering safety for the NPRM, EPA obtained NHTSA input. EPA obtained additional NHTSA safety input regarding comments and updates for the final rulemaking.<sup>258</sup>

Moreover, empirical evidence from the light-duty sector (where BEVs have been on the road in greater numbers and

for a longer period), shows that BEVs “are at least as safe” as combustion vehicles in terms of crashworthiness test performance, and “injury claims are substantially less frequent” for BEVs than for combustion vehicles.<sup>259</sup> A DOE study found that on some safety metrics, BEVs perform substantially better than ICE vehicles. Due to their battery architecture, for example, BEVs typically have a lower center of gravity than combustion vehicles, which increases stability and reduces the risk of rollovers (the cause of up to 35 percent of accident deaths).<sup>260</sup> Most vehicle weight classes do not change. The distribution of HD vehicle weights may shift higher with BEV adoption but the maximum allowed weight for a given weight class does not change. The one exception is for BEV Class 8 that are allowed to increase their GCWR from 80,000 lbs to 82,000, a 2.5 percent increase.<sup>261</sup> We coordinated with NHTSA to assess the safety concerns due to vehicle weight. NHTSA is not aware of differences in crash outcomes between electric and non-electric vehicles. See RTC section 4.8. NHTSA is monitoring this topic closely and is conducting extensive research on the potential differences between ICE and electric vehicles.

Fire risk, emergency response, and maintenance can also be managed effectively. There is evidence (discussed more fully in RTC section 4.8) that BEVs are less likely to catch fire than internal combustion engine vehicles. Although BEVs can behave differently in fires from ICE vehicles, emergency responders have been gaining experience in BEV fire response as the number of BEVs on the road has grown, and there are protocols and guidance at the Federal and private levels in support of first responders. Similar protocols and guidance exist to mitigate shock risk to mechanics during maintenance and repair.

In sum, the public and private sectors have been working diligently to address BEV safety considerations. While current standards are appropriate, optimization efforts will continue as the HD BEV industry matures. Heavy-duty BEVs can be and are designed and operated safely, and EPA therefore did

not treat safety as a constraining factor in this rulemaking.

ii. Assessment of Battery Materials and Production

ICE vehicles and BEVs both require manufacturing inputs in the form of materials such as structural metals, plastics, electrical conductors, electronics and computer chips, and many other materials, minerals, and components that are produced both domestically and globally. These inputs rely to varying degrees on a highly interconnected global supply chain that includes mining and recycling operations, processing of mined or reclaimed materials into pure metals or chemical products, manufacture of vehicle components, and final assembly of vehicles.

Compared to ICE vehicles, the electrified powertrain of BEVs commonly contains a greater proportion of conductive metals such as copper as well as specialized minerals and mineral products that are used in the high-voltage battery. Accordingly, many of the public comments we received were related to the need to secure sources of these inputs to support increased manufacture of BEVs for the U.S. market.<sup>262</sup>

First, it is important to view this issue from a perspective that includes the inputs currently required by ICE vehicles, where comparable issues have arisen and have been successfully surmounted. Compared to BEVs, ICE vehicles rely to a greater degree on certain inputs, most notably refined crude oil products such as gasoline or diesel, and critical minerals (for example, platinum group metals) used in emission control catalysts. Historically, supply and price fluctuations of crude oil products have periodically created significant risks, costs, and uncertainties for the U.S. economy and for national security, and continue to pose them today. The critical minerals used in emission control catalysts of ICE products, such as cerium, palladium, platinum, and rhodium, historically have posed particular uncertainty and risk regarding their reliable supply. Although manufacturers have engineered emission control systems to reduce the amount of these minerals that are needed, they continue to be scarce and costly today, and continue to be largely sourced from other countries. For example, South Africa and Russia

<sup>262</sup> FCEVs use smaller batteries than BEVs, but those batteries would require use of the same minerals. The text in this section is written in terms of BEVs but is relevant to FCEV batteries as well.

<sup>258</sup> Landgraf, Michael. Memorandum to docket EPA-HQ-OAR-2022-0985. Summary of NHTSA Safety Communication. February 2024.

<sup>259</sup> Insurance Institute for Highway Safety, “With More Electric Vehicles Comes More Proof of Safety” (April 22, 2021), <https://www.iihs.org/news/detail/with-more-electric-vehicles-comes-more-proof-of-safety>.

<sup>260</sup> U.S. Department of Energy, “Maintenance and Safety of Electric Vehicles”, [https://afdc.energy.gov/vehicles/electric\\_maintenance.html](https://afdc.energy.gov/vehicles/electric_maintenance.html) (October 23, 2023).

<sup>261</sup> 23 U.S.C. 127(s).

continue to be dominant suppliers of these metals as they were in the 1970s, and U.S. relations with both countries have periodically been strained. In this sense, the need for a secure supply chain for the inputs required for BEV production is not unlike that which continues to be important for ICE vehicle production.

The BEV supply chain is characterized as consisting of several activity stages including upstream, midstream, and downstream, which includes end-of-life. Upstream refers to extraction of raw materials from mining activities. Midstream refers to additional processing of raw materials into battery-grade materials, production of electrode active materials (EAM), production of other battery components (*i.e.*, electrolyte, foils, and separators), and electrode and cell manufacturing. Downstream refers to production of battery modules and packs from battery cells, and end-of-life refers to recovery and processing of used batteries for reuse or recycling. Global demand for zero-emission vehicles has already led to rapidly growing demand for capacity in each of these areas and subsequent buildout of this capacity across the world. We discuss each of these activity stages in the following sections of this preamble.

The value of developing a robust and secure supply chain that includes these activities and the products they create has accordingly received broad attention in the industry and is a key theme of comments we have received. The primary considerations here are (a) the capability of global and domestic supply chains to support U.S. manufacturing of batteries and other ZEV components, (b) the availability of critical minerals as manufacturing inputs, and (c) the possibility that sourcing of these items from other countries, to the extent it occurs, might pose a threat to national security. In addition, there is the further question of the adequacy of the battery supply chain to meet potential demand resulting from a Phase 3 rule. In this section, EPA considers how these factors relate to the feasibility of producing the BEVs that manufacturers may choose to produce to comply with the standards.

In the proposal, we highlighted several key reasons that led us to conclude that the proposed standards were appropriate with respect to minerals availability, the battery supply chain, and minerals security as it relates to national security. 88 FR 28962–969. First we noted that minerals, battery components, and batteries themselves are largely sourced from outside of the U.S., not because the products cannot be

produced in the U.S., but because other countries have already invested in developing this supply chain, while the U.S. largely has begun developing a domestic battery supply chain more recently. The rapid growth in domestic demand for automotive lithium-ion batteries that is already taking place is driving the development of a supply chain for these products that includes development of domestic sources, as well as rapid buildout of production capacity in countries with which the U.S. has friendly relations, including countries with free trade agreements (FTAs) and long-established trade allies. For example (as described later in this section), U.S. manufacturers are increasingly seeking out secure, reliable and geographically proximate supplies of batteries, cells, components, and the minerals and materials needed to build them; this is also necessary to remain competitive in the global automotive market where electrification is proceeding rapidly. As a result, a large number of new domestic battery, cell, and component manufacturing facilities have recently been announced or are already under construction.<sup>263</sup> Many automakers, suppliers, startups, and related industries have already recognized the need for increased domestic and “friendshored” production capacity as a business opportunity and are investing in building out various aspects of the supply chain domestically.

Second, we noted that Congress and the Administration have taken significant steps to accelerate this activity by funding, facilitating, and otherwise promoting the rapid growth of U.S. and allied supply chains for these products through the Inflation Reduction Act (IRA), the Bipartisan Infrastructure Law (BIL), the National Defense Authorization Act (NDAA), and numerous Executive Branch initiatives. Recent and ongoing announcements of investment and construction activity stimulated by these measures indicate that they are having a strong impact on development of the domestic supply chain, as illustrated by recent analysis from Argonne National Lab and U.S. DOE.<sup>264</sup> Finally, while minerals may be imported to the U.S. for domestic vehicle or battery production in the U.S., minerals, in contrast to liquid fuels, have the potential to be reclaimed through recycling, reducing the need for

new materials from either domestic or foreign sources over the long term. In this updated analysis for the final rule, we examine these themes again in light of the public comments and additional data that has become available since the proposal.

We received many comments on our analysis of critical minerals, battery and mineral production capacity, and critical mineral security. Some common themes were: that the proposal did not adequately address critical minerals or battery manufacturing; that the proposal did not adequately address the risk associated with uncertain availability of critical minerals in the future; and that the timeline and/or degree of BEV penetration anticipated by the proposal cannot be supported by available minerals and/or growth in domestic supplies or battery manufacturing. Many of the concerns stated by commenters about the supply chain, critical minerals, and mineral security were stated as part of a broader argument that the proposed standards were too stringent; that is, that the commenter believed that the standards should be weakened (or withdrawn entirely) because the supply chain or the availability of critical minerals could not support the amount of vehicle electrification that would result from the standards, or it would create a reliance on imported products that would threaten national security.

For this final rule we considered the public comments carefully. We have provided detailed responses to comments relating to critical minerals, the supply chain, and mineral security in this preamble and in section 17.2 of the Response to Comments. We also continued our ongoing consultation with industry and government agency sources (including the Department of Energy (DOE) and National Labs, the U.S. Geological Survey (USGS), and several analysis firms) to collect information on production capacity forecasts, price forecasts, global mineral markets, and related topics. We also coordinated with DOE in their assessment of the outlook for supply chain development and critical mineral availability. DOE is well qualified for such research, as it routinely studies issues related to electric vehicles, development of the supply chain, and broad-scale issues relating to energy use and infrastructure, through its network of National Laboratories. DOE worked together with Argonne National Laboratory (ANL) beginning in 2022 to assess global critical minerals availability and North American battery components manufacturing, and coordinated with EPA to share the

<sup>263</sup> See section II.D.2.c.ii.b of this preamble for further discussion.

<sup>264</sup> Argonne National Laboratories, “Quantification of Commercially Planned Battery Component Supply in North America through 2035” (ANL–24/14) (March 2024) (“Planned Battery Supply”).

results of these analyses during much of 2023 and early 2024. In this subsection we review the main findings of this work, along with the additional information we have collected since the proposal. As in the proposal, we have considered the totality of information in the public record in reaching our conclusions regarding the influence of future manufacturing capacity, critical minerals and related supply chain availability, and mineral security on the feasibility of the final standards.

As will be discussed in the following sections, our updated assessment supports our conclusion that the standards are technically feasible taking into consideration issues of critical mineral and supply chain availability, adequacy of battery production, and critical mineral security. Our assessment of the evidence likewise continues to support the conclusion that the likely rate of development of the domestic and global supply chain and forecast availability of critical minerals or materials on the global market are consistent with the final standards being met at a reasonable cost (assuming compliance in the same or similar manner set out in the technology packages in the modeled potential compliance pathway). Further, based on DOE and ANL's analyses which analyze the current and future state of the global and domestic supply chains, along with other sources as described in this preamble, we find no evidence that compliance with the standards will adversely impact national security by creating a long-term dependence on imports of critical minerals or components from adversarial countries or associated suppliers. Moreover, we expect that the standards will provide increased regulatory certainty for domestic production of batteries and critical minerals, and for creating domestic supply chains, which in turn has the potential to strengthen the U.S.'s global competitiveness in these areas.

As explained in the following sections, these results indicate that in the near- and medium-term, the currently identified capacity for lithium, cobalt, and nickel in the U.S. and Free Trade Agreement and Mineral Security Partnership countries is significantly greater than U.S. demand under representative domestic demand scenarios. Sufficient supply of graphite is likewise available considering secure international trade partnerships, and taking into account supply of synthetic and recycled graphite if needed. In particular, the U.S. is poised to become a key global producer of lithium, and, along with supply from Free Trade Agreement partners, is positioned well

for lithium through 2035. We note that an accounting of known mineral reserves in democratic countries across the world indicates that the reserves surpass projected global needs through 2030 for the five minerals assessed by ANL, under a demand scenario that limits global temperature rise to 1.5 °C.<sup>265</sup> 'Reserves' here refers to "measured and indicated deposits that have been deemed economically viable"<sup>266</sup> and so is not measuring mere presence of a resource. While this statistic does not demonstrate that these reserves will be extracted in any specific time frame, it demonstrates their presence and potential availability. As demand increases, particularly for secure supplies, further exploration and development of existing resources in these countries is likely to further increase these reserves.

EPA notes that no analysis of future outcomes with regard to supply chain viability, critical minerals availability, or mineral security can be absolutely certain. The presence of uncertainty is inherent in any forward-looking analysis and is typically approached as a matter of risk assessment, including sensitivity analysis conducted around costs, compliance paths, or other key factors. We also again note that compliance with the final standards is possible under a broad range of reasonable scenarios, including a pathway without additional production of ZEVs to comply with the final standards. Demand for battery production and critical minerals would be significantly reduced under such potential alternative pathways to compliance.

Section II.D.2.c. ii.a of this preamble examines the issues surrounding availability of critical mineral inputs. Section II.D.2.ii.b examines issues relating to adequacy of battery production. Section II.D.2.c.ii.c discusses the security implications of increased demand for critical minerals and other materials used to manufacture electrified vehicles. Additional details on these aspects of the analysis may be found in RIA Chapter 1.5.1.

<sup>265</sup> Allan, B. et al., "Friendshoring Critical Minerals: What Could the U.S. and Its Partners Produce?", Carnegie Endowment for International Peace, May 3, 2023. At <https://carnegieendowment.org/2023/05/03/friendshoring-critical-minerals-what-could-u.s.-and-its-partners-produce-pub-89659>.

<sup>266</sup> Similarly, the USGS defines reserves as "that part of the reserve base which could be economically extracted or produced at the time of determination. The term reserves need not signify that extraction facilities are in place and operative." U.S. Bureau of Mines and the U.S. Geological Survey, "Principles of a Resource/Reserve Classification For Minerals," Geological Survey Circular 831, 1980.

a. Battery Critical Minerals Availability

The Energy Act of 2020 defines a "critical mineral" as a non-fuel mineral or mineral material essential to the economic or national security of the United States and which has a supply chain vulnerable to disruption.<sup>267</sup> The U.S. Geological Survey lists 50 minerals as "critical to the U.S. economy and national security."<sup>268 269</sup> Risks to mineral availability may stem from geological scarcity, geopolitics, trade policy, or similar factors.<sup>270</sup> Critical minerals range from relatively plentiful materials that are constrained primarily by production capacity and refining, such as aluminum, to those that are both relatively difficult to source and costly to process, such as the rare-earth metals that are used in magnets for permanent-magnet synchronous motors, which are used as the electric motors to power heavy-duty ZEVs and some semiconductor products. Extraction, processing, and recycling of minerals are key parts of the supply chain that affect the availability minerals. For the purposes of this rule, we focus on a key set of minerals (lithium, cobalt, nickel, manganese, and graphite) commonly used in BEVs; their general availability impacts the production of battery cells and battery components.

Demand for these minerals is increasing, largely driven by the transportation and energy storage sectors, as the world seeks to reduce carbon emissions and as the electrified vehicles and renewable energy markets grow. As with any emerging technology, a transition period must take place in which robust supply chains develop to support production and distribution. At present, minerals used in BEV batteries are commonly sourced from global suppliers and do not rely on a fully

<sup>267</sup> See 2021 Draft List of Critical Minerals (86 FR 62199–62203).

<sup>268</sup> U.S. Geological Survey, "U.S. Geological Survey Releases 2022 List of Critical Minerals," February 22, 2022. Available at: <https://www.usgs.gov/news/national-news-release/us-geological-survey-releases-2022-list-critical-minerals>.

<sup>269</sup> The full list includes: Aluminum, antimony, arsenic, barite, beryllium, bismuth, cerium, cesium, chromium, cobalt, dysprosium, erbium, europium, fluorspar, gadolinium, gallium, germanium, graphite, hafnium, holmium, indium, iridium, lanthanum, lithium, lutetium, magnesium, manganese, neodymium, nickel, niobium, palladium, platinum, praseodymium, rhodium, rubidium, ruthenium, samarium, scandium, tantalum, tellurium, terbium, thulium, tin, titanium, tungsten, vanadium, ytterbium, yttrium, zinc, and zirconium. Note that the Department of Energy (DOE) does not classify manganese as a critical mineral.

<sup>270</sup> International Energy Agency, "The Role of Critical Minerals in Clean Energy Transitions," World Energy Outlook Special Report, Revised version, March 2022.

developed domestic supply chain.<sup>271</sup> As demand for these materials increases due to projected increasing production of BEVs, production of critical minerals is expected to grow. As noted previously in this section, the need for a secure supply chain for the inputs required for BEV production is not unlike that which continues to be important for ICE vehicle production, given the presence of minerals in ICE vehicles, and given difficulties and challenges posed by sourcing liquid fuels for ICE vehicles described throughout this document. The focus on lithium, cobalt, nickel, manganese, and graphite, stems from the fact that their increased use is unique to BEVs compared with ICE vehicles. Electrified vehicles at present utilize lithium-ion batteries, though alternative battery types are in development or are already being deployed in some limited applications. In the near-term, there is not a viable alternative to lithium in BEV batteries. As noted previously, common cathode chemistries today for lithium-ion batteries include nickel-manganese-cobalt (NMC), nickel-cobalt-aluminum (NCA), and iron-phosphate (LFP). While lithium is used in all lithium-ion batteries, cathode chemistry is somewhat flexible, which can help adapt to both supply-based factors and end-use needs. For example, LFP batteries have been increasing in use given the constraints of cobalt and

nickel sourcing. LFP batteries may also be better suited for vehicles without extended ranges, as they are less energy dense. Put more broadly, cathode chemistry varies, and as such can adjust the demand for certain minerals, or can eliminate the demand for certain minerals entirely.

Anode chemistry can also accommodate alternative chemistries. Most commonly, BEVs use a graphite anode, supply constraints for which are described further below; however, silicon can replace graphite in an anode, and graphite anodes containing a portion of silicon now make up around 30 percent of anodes according to the IEA as of 2023.<sup>272</sup> It is also possible to use alternative forms of carbon in the anode, and unlike other minerals used for BEVs, graphite can be produced synthetically.

Given the possibilities for substitution for other minerals, EPA focused its own analysis on lithium availability as a potential limiting factor on the rate of growth of ZEV production, and thus the most appropriate basis for establishing a modeling constraint on the rate of ZEV penetration into the fleet over the time frame of this rule. At proposal, EPA found that the lithium market was responding robustly to demand, and that global supply would be adequate at least through 2035. 88 FR 25965 and sources there cited. We further found that notwithstanding short-term price fluctuations in price, the price of lithium “is expected to stabilize at or near its historical levels by the mid- to late-2020s.” 88 FR 25966 and sources

there cited. At proposal, we concluded that the scale and pace of demand growth and investment in lithium supply means that it is well positioned to meet anticipated demand as demand increases and supply grows. See RIA Chapter 1.5.1.3 for further explanation of focus on lithium as the most important of the critical minerals as a potential constraint.

More recent information is corroborative and expands the scope of analysis to include the five minerals listed previously in this section. ANL has performed a review of international and domestic critical minerals availability as of February 2024, which EPA considers to be both thorough and up to date.<sup>273</sup> The analysis finds that while the U.S. will need imports to bolster supply for most key minerals, these imports can come from friendly nations, and be bolstered by growing domestic supply, especially for lithium. The analysis also finds that, with the appropriate policies and enabling approaches in place, the U.S. can secure the minerals it needs by relying on domestic production as well as on trade relationships with allies and partners (Figure II–1). USGS is engaged in activities that, while not yet quantifiable, are enabling the U.S. to expand a secure supply chain for critical minerals among U.S. allies and partner nations. There are substantial efforts to scale mining supply domestically and in partner countries underway, further described in this section II.D.2.c.ii.c.

<sup>271</sup> As mentioned in preamble section I.C.2.i and in RIA 1.3.2.2, there are tax credit incentives in the IRA for the production and sale of battery cells and modules of up to \$45 per kWh, which includes up to 10 percent of the cost of producing applicable critical minerals that meet certain specifications when such components or minerals are produced in the United States.

<sup>272</sup> <https://www.iea.org/reports/global-ev-outlook-2023/trends-in-batteries>.

<sup>273</sup> Argonne National Laboratory, “Securing Critical Materials for the U.S. Electric Vehicle Industry” (March, 2024) (ANL–24/06) (“ANL”).

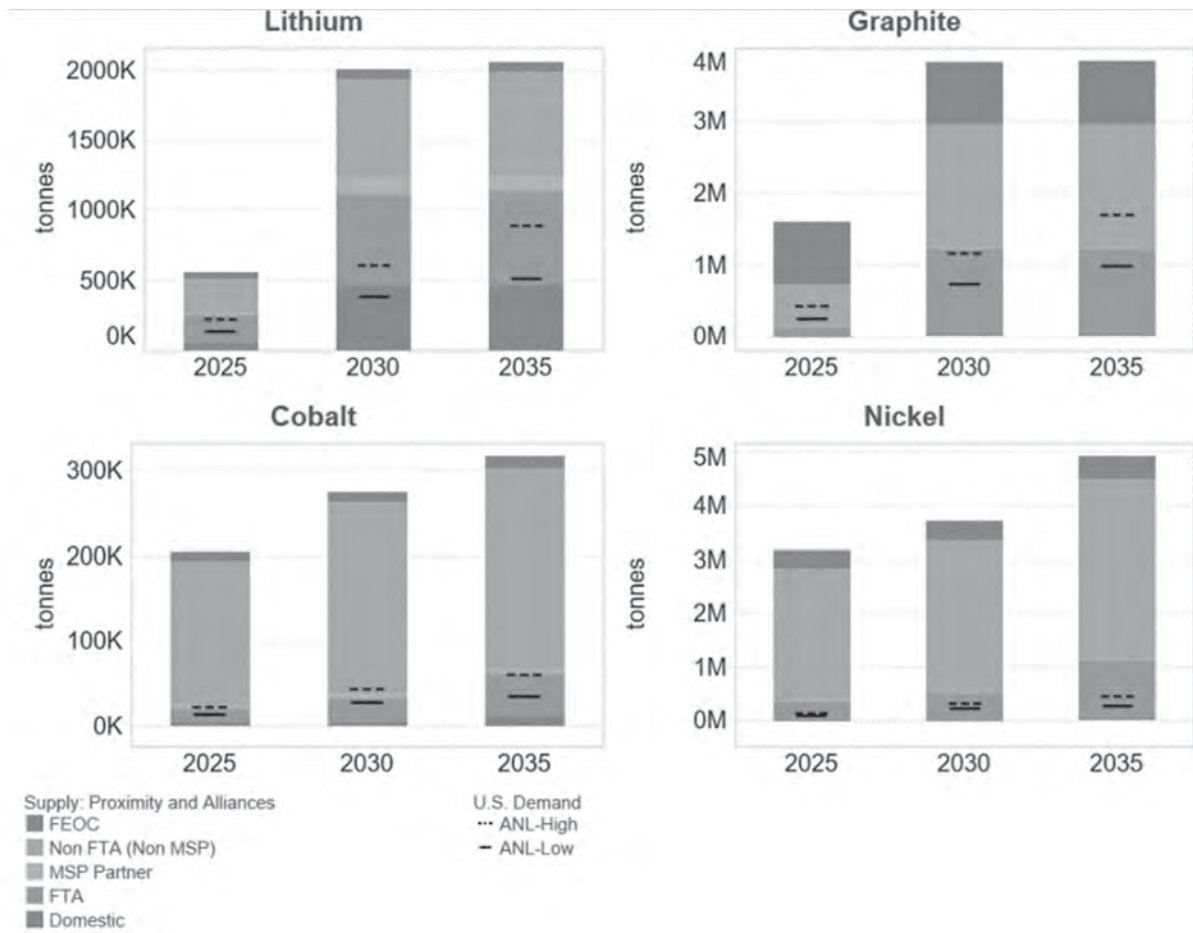

**Figure II-1 Potential upstream mined critical materials supply, tonnes/year, grouped by location of mine production (Source: ANL Figure 2).**

The updated ANL critical minerals study finds that the U.S. is poised to become a key global producer of lithium by 2030, and could become one of the world’s largest producers of lithium by 2035. In the near term (the next few years), manufacturers will need to import lithium, and ample capacity exists to source lithium from countries

with whom the United States has free trade agreements (FTA).<sup>274</sup> As detailed in the ANL study, numerous lithium extraction projects are in various stages of development many of which were also cited in public comments, including Fort Cady, Thacker Pass, Rhyolite Ridge, and Kings Mountain.<sup>275</sup>

The ANL study continues to confirm a trend of rapidly growing identification of U.S. lithium resources and extraction development. The identification of these resources, some of which were publicly announced within the last year, exemplifies the dynamic nature of the industry and the likely conservative aspect of existing assessments.

<sup>274</sup> ANL at 36, 38 (Australia and Chile), 53. The Minerals Security Partnership (MSP) is a transnational association whose members seek to secure a stable supply of raw materials for their

economies. As of September 16, 2023, the MSP was composed of: Australia, Canada, Finland, France, Germany, India, Japan, South Korea, Sweden,

Norway, the United Kingdom, the United States, and the European Union.

<sup>275</sup> ANL at 34.

Table II-7 Examples of domestic lithium projects identified by ANL (ANL Table 2)

Property name	Development stage	Anticipated annual capacity (tonnes LCE)	State	Projected start date <sup>a</sup>	Data source
Paradox	Feasibility Complete	13,074	Utah	2025	Anson Resources
Silver Peak	Operational	5,000	Nevada	Active	Steven, 2022
South-West Arkansas	Prefeasibility complete	26,400	Arkansas	2027	Standard Lithium
Fort Cady	Under Construction	4,990	California	2026	5E Advanced Materials
Clayton Valley (Zeus)	Preliminary assessment/Prefeasibility	31,900	Nevada	2030	Noram Lithium Corp
Round Top	Preliminary assessment/Prefeasibility	9,800	Texas	2030	Texas Mineral Resource Corp
Clayton Valley	Feasibility Started	27,400	Nevada	2028	Century Lithium
Thacker Pass (Phase I)	Under Construction	40,000	Nevada	2026	Lithium Americas
Thacker Pass (Phase II)	Construction Planned	80,000	Nevada	2029	Lithium Americas
Piedmont	Feasibility Complete	26,400	North Carolina	2025	Piedmont Lithium
Rhyolite Ridge	Construction Planned	20,600	Nevada	2026	Ioneer
TLC Phase I	Prefeasibility	24,000	Nevada	2028	American Lithium
ABTC	Construction Planned	26,400	Nevada	2026	American Battery Technology Co
Kings Mountain	Under Construction	50,000	North Carolina	2026	Albemarle

<sup>a</sup>The start dates for the projects are adopted as provided through press releases or company investor reports. In cases where an anticipated start date is not specified, ANL provides an estimated start date. This estimate is based on assumptions about the typical timeline for project initiation, provided all necessary elements align as anticipated. It is important to note that any failure in meeting necessary prerequisites such as technical requirements, sustaining project economics, permitting, or financing could result in project delays or, in extreme cases, even cancellation. Thus, actual start dates could be earlier or later than reported here. The data was last updated in February 2024. The list only includes projects with publicly available information and is intended solely for illustrative purposes. Some evaluated projects are excluded from this list.

This update to DOE’s lithium resource compilation continues to confirm the trend of growing U.S. mineral development. As depicted in Figure II-2, DOE and ANL assessed announced

domestic lithium extraction projects to project domestic lithium supply through 2035, along with domestic lithium recycling potential, and compared these to estimated demand. The projects

included in the updated analysis represent a significant increase over the domestic lithium supply considered for the proposal, exemplifying the dynamic nature of the industry.

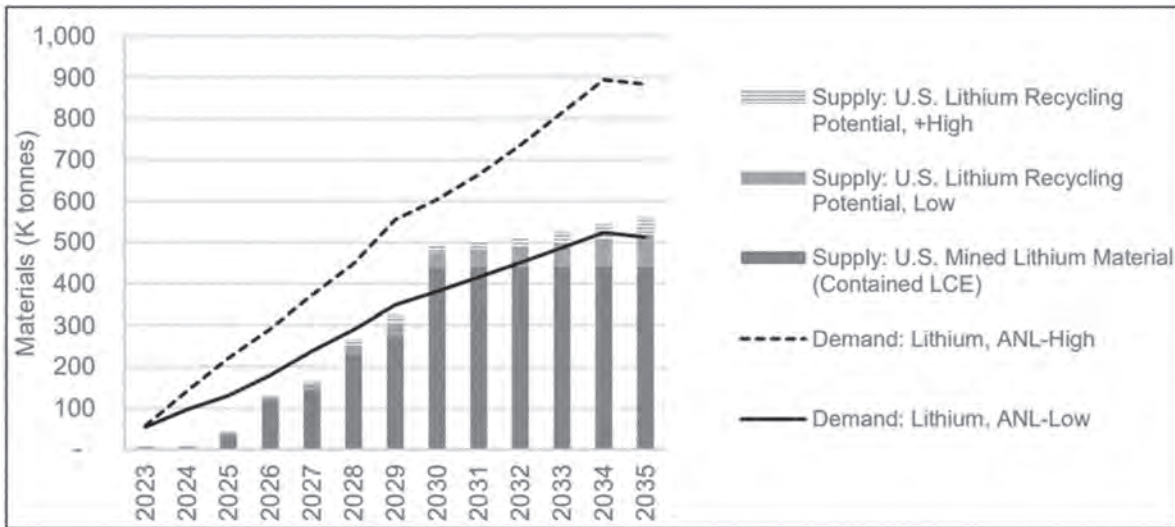

Figure II-2 Potential U.S supply in meeting 100 percent U.S. battery capacity (ANL Figure 26).

Regarding global lithium production, we have also supplemented our lithium

analysis from the proposal with newly available research and information. The

outlook for lithium production has evolved rapidly, with new projects

regularly identified and contributing to higher projections of resource availability and production. Benchmark Minerals Intelligence (BMI) conducted a comprehensive analysis of global and domestic lithium supply and demand in June 2023 that indicates that lithium supply is likely to keep pace with growing demand during the time frame of the rule.<sup>276</sup> In the Figure II-3 below, the vertical bars (at full height) represent estimated global demand, including U.S. demand. The top

segment of each bar represents BMI's estimate of added U.S. demand under the proposed light and medium duty vehicle rule, and the proposed HD Phase 3 rule. The lower line represents BMI's projection of global lithium supply (including U.S.) in GWh equivalent, weighted by current development status of each project. The next line represents global supply where the U.S. portion is unweighted (*i.e.*, all included projects reach full expected production). These two lines together

represent a potential range for future global supply bounded by a standard weighted scenario and a maximum scenario applied to U.S. production only. In both cases, projected global lithium supply meets or surpasses projected global demand through 2029. Past 2029, global demand is either generally met or within 10 percent of projected demand through 2032. For reference, the top line is a high supply scenario in which global supply is also unweighted.

### Global Lithium Supply Based on Current Announcements of Projected Production — GWh-basis

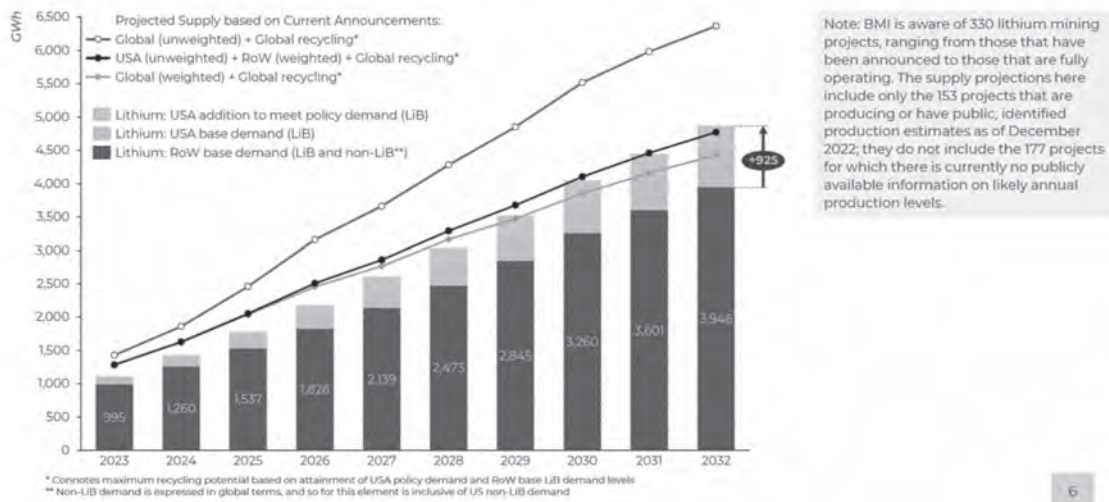

**Figure II-3 Global Lithium Supply Based on Current Announcements of Projected Production Along with Global and U.S. Lithium Demand (with demand expressed as GWh)**

EPA notes that BMI based its estimate of U.S. demand on electrified vehicle penetrations under the proposed standards, which projected higher electrified vehicle penetrations than in the final standards. This means that the top segment of each bar would be shorter under the final standards, making the depicted results more conservative.

EPA also notes that although BMI states that it is aware of 330 lithium mining projects ranging from announced projects to fully operating projects and stages in between, the supply projections shown here are limited to only 153 projects that are already in production or have publicly identified production estimates as of

December 2022 (more than one year ago). Excluded from both the weighted and unweighted supply projections are 177 projects for which no information on likely production level was available. It is standard practice to weight projects that have production estimates according to their stage of development, and BMI has followed this practice with the 153 projects. However, complete exclusion of the potential production of 177 projects (more than half of the total) suggests that the projections shown may be extremely conservative. If even a very conservative estimate of ultimate production from these 177 projects by 2030 were to be added to the chart, projected supply would increase and perhaps meet or surpass demand. At

this time of rising mineral demand coupled with active private investment and U.S. government activities to promote mineral resource development, exclusion of potential production from these resources is not likely to reflect their future contribution to U.S. supply.

In mid-2023, some analysts began speaking of the possibility of a future tightness in global lithium supply.<sup>277</sup> Opinions varied, however, about its potential development and timing, with the most bearish opinions suggesting as early as 2025 with others suggesting 2028 or 2030. However, the projections from BMI and ANL discussed previously in this section suggest only a mild gap developing in global supply and demand in 2030 and only if the 177

<sup>276</sup> Benchmark Mineral Intelligence (BMI), "Lithium Mining Projects—Supply Projections (June 2023). See also Supplemental Comment Letter

re BMI Analysis from Natural Resources Defense Council (January 2024).

<sup>277</sup> Shan, Lee Ying, "A worldwide lithium shortage could come as soon as 2025" (August

2023) at [www.cnn.com/2023/08/29/a-worldwide-lithium-shortage-could-come-as-soon-as-2025.html](http://www.cnn.com/2023/08/29/a-worldwide-lithium-shortage-could-come-as-soon-as-2025.html).

projects that were not quantified do not contribute (BMI), or no significant gap in U.S. lithium supply and demand during the time frame of the rule (ANL). Further, the analysts quoted as predicting a future tightness stop well short of identifying an unavoidable hard constraint on lithium availability that would reasonably lead EPA to conclude that the standards cannot be met. Forecasts of potential supply and demand, including those that purport to identify a supply shortfall, typically are also accompanied by descriptions of burgeoning activity and investment oriented toward supplying demand, rather than a paucity of activity and investment that would be more indicative of a critical shortage. EPA also notes that since the time of the referenced article, demand for lithium has increasingly been depicted as having underperformed peak expectations. The final standards also project a lower ZEV penetration than in the proposal, which would lead to lower demand from the standards than the proposal would have suggested.

Regarding concerns about lithium price fluctuations addressed by commenters, recent unexpected drops in lithium prices beginning in early 2023<sup>278</sup> and persisting to the present are believed to have been the result of robust growth in lithium supply from developments similar to these. This supports EPA's expectation that mineral prices will not continually rise as some commenters have suggested but will find an equilibrium within a reasonable range of prices as the rapidly growing supply chain continues to mature. Despite recent short-term fluctuations in price, the price of lithium is expected to stabilize at or near its historical levels by the mid-2020s, according to outside analysis.<sup>279</sup><sup>280</sup> This perspective is also supported by proprietary battery price forecasts by Wood Mackenzie that include the predicted effect of temporarily elevated mineral prices and show battery costs falling again past 2024.<sup>281</sup><sup>282</sup> This is also consistent with

<sup>278</sup> New York Times, "Falling Lithium Prices Are Making Electric Cars More Affordable," March 20, 2023. Accessed on March 23, 2023 at <https://www.nytimes.com/2023/03/20/business/lithium-prices-falling-electric-vehicles.html>. See also The Economist, January 6, 2024 at 54: "[m]ined supply of lithium and nickel is also booming; that of cobalt, a by-product of copper and nickel production, remains robust, dampening green-metal prices."

<sup>279</sup> Sun et al., "Surging lithium price will not impede the electric vehicle boom," <https://www.sciencedirect.com/science/article/pii/S2542435122003026>.

<sup>280</sup> Green Car Congress, "Tsinghua researchers conclude surging lithium price will not impede EV boom," July 29, 2022.

<sup>281</sup> Wood Mackenzie, "Battery & raw materials—Investment horizon outlook to 2032," September

the BNEF's newly released 2023 Battery Price Survey which shows that pack prices have resumed their downward trend, and predicts that average pack prices across all automotive and stationary uses will fall to \$113 per kWh in 2025 and \$80 per kWh in 2030.<sup>283</sup>

In addition to lithium, EPA carefully considered the availability of nickel, cobalt, manganese, and graphite at proposal and for this final rule. At proposal, we noted the global sources of these materials, and global refining sources. We further explained how United States domestic production of these materials lagged global production notwithstanding domestic reserves of nickel, cobalt, and lithium; however, the developing supply chain domestically and abroad can meet domestic demand over the next decade. 88 FR 25963.

More recent information from ANL confirms these initial findings and supports that supply and supply chains for these minerals will be adequate to meet domestic demand in the Phase 3 rule's timeframe. Below are summaries of the ANL report's findings.

While the U.S. nickel production industry is expanding, in the near- and medium-term, there is sufficient capacity in countries with which the U.S. has long-standing or emerging trade partnerships to meet demand for nickel. Some nickel will come from countries with free trade agreements (FTA) and in the Minerals Security Partnership (MSP), a multilateral effort to responsibly secure critical mineral supply chains (Canada, Australia, Finland, Norway), though likely much of it will come from other trade partners (Indonesia, Philippines and others).<sup>284</sup> The U.S. is engaged in several initiatives with these countries to expand and diversify nickel supply (detailed further in section II.D.2.ii.c of this preamble), and some domestic nickel production is also in development.

There are initial efforts to scale up cobalt production in FTA countries, but the bulk of supply will continue to come from the Democratic Republic of Congo, with Australia (which has an FTA with the U.S. and is a member of the MSP) and Indonesia being

2022 (filename: brms-q3-2022-ih0.pdf). Available to subscribers.

<sup>282</sup> Wood Mackenzie, "Battery & raw materials—Investment horizon outlook to 2032," accompanying data set, September 2022 (filename: brms-data-q3-2022.xlsx). Available to subscribers.

<sup>283</sup> BloombergNEF, "Lithium-Ion Battery Pack Prices Hit Record Low of \$139/kWh," November 27, 2023. Accessed on December 6, 2023 at <https://about.bnef.com/blog/lithium-ion-battery-pack-prices-hit-record-low-of-139-kwh>.

<sup>284</sup> ANL at 44. We discuss availability of nickel refining capacity below in considering mineral security.

secondary sources, plus some domestic production from the six<sup>285</sup> prospective cobalt projects that have potential to come online before 2035.<sup>286</sup> This supply is projected to be sufficient to meet demand. BloombergNEF now similarly projects that cobalt and nickel reserves "are now enough to supply both our Economic Transition and Net Zero scenarios," the latter of which is an aggressive global decarbonization scenario.<sup>287</sup> It is also significant that the U.S. cobalt spot price dropped by nearly 42 percent in the past year (2023–2024), indicating ample current supply.<sup>288</sup> U.S. efforts to secure the global cobalt supply chain are discussed further in section II.D.2.ii.c of this preamble.

Manganese is not considered to be a "critical" mineral as defined by USGS or by DOE; however, it is an important mineral for BEV batteries.<sup>289</sup> Capacity from FTA and MSP partners is projected to be sufficient to meet domestic demand in both the near and medium term, as significant reserves are located in Australia, Canada, and India.<sup>290</sup> In addition, recycling may prove to be a growing source of supply starting in the early 2030s.<sup>291</sup>

In the near-term, graphite demand is unlikely to be met through domestic sources or through trade with FTA countries or directly from MSP countries.<sup>292</sup> However, scaling domestic synthetic graphite production and continued innovation can mitigate this risk. In the medium term, supply sources of natural graphite are expected to become more diverse with new planned capacity in both FTA (Canada and Australia) and other economic partners (Tanzania and Mozambique) and others supported by the MSP. Although the U.S. has significant deposits of natural graphite, graphite has not been produced in the U.S. since the 1950s and significant known resources remain largely undeveloped.<sup>293</sup> ANL notes that China dominates natural graphite production and has been a major source of U.S

<sup>285</sup> ANL at 48.

<sup>286</sup> We discuss availability of cobalt refining capacity below in our discussion of issues relating to mineral security.

<sup>287</sup> BloombergNEF, "Electric Vehicle Outlook 2023," Executive Summary, p. 5.

<sup>288</sup> [https://ycharts.com/indicators/us\\_cobalt\\_spot\\_price#:~:text=US%20Cobalt%20Spot%20Price%20is,22.79%25%20from%20one%20year%20ago](https://ycharts.com/indicators/us_cobalt_spot_price#:~:text=US%20Cobalt%20Spot%20Price%20is,22.79%25%20from%20one%20year%20ago) (last accessed March 19, 2024).

<sup>289</sup> DOE Critical Materials Report—2023 ([www.energy.gov](http://www.energy.gov)).

<sup>290</sup> ANL at 63.

<sup>291</sup> ANL at 62–63.

<sup>292</sup> ANL at 52, 57.

<sup>293</sup> U.S. Geological Survey, "USGS Updates Mineral Database with Graphite Deposits in the United States," February 28, 2022.



imports; however, China has recently moved to curb exports of graphite, imposing an export permit requirement on graphite in 2023, which will temporarily reduce graphite exports due to a 45-day application period for permits. This suggests that graphite exports from China may be controlled in the future. However, at this time it is not clear that this requirement will meaningfully impact exports over the long term, as similar permit requirements have existed on other exports, including those necessary in ICE vehicle production.<sup>294</sup> Wood Mackenzie reports that a change to material flows is unlikely, and that a graphite supply chain outside of China is rapidly developing.<sup>295</sup> In fact, this export restriction is expected to be a catalyst for swiftly expanding the domestic graphite supply from conventional and non-conventional sources.<sup>296</sup> ANL also indicates that synthetic graphite scaling has potential to mitigate graphite risk in the medium term.<sup>297</sup> Already, about 58 percent of the world's graphite is synthetic.<sup>298</sup> Innovation can also help curb pressure on the graphite supply chain, with silicon's use in battery anodes expected to expand tenfold by 2035 according to SNE research, displacing the need for some graphite.<sup>299</sup>

<sup>292</sup> ANL at 52, 57.

<sup>293</sup> U.S. Geological Survey, "USGS Updates Mineral Database with Graphite Deposits in the United States," February 28, 2022.

<sup>294</sup> Rare earths, necessary for catalytic converters and magnet motors are presently subject to Chinese export license restrictions for example. <https://www.fastmarkets.com/insights/chinas-commerce-ministry-to-add-rare-earth-to-export-report-directory>.

<sup>295</sup> Wood Mackenzie, "How will China's graphite export controls impact electric vehicle supply chain?" subscriber material presentation, November 2, 2023.

<sup>296</sup> See China's Graphite Curbs Will Accelerate Plans Around Alternatives (usnews.com).

<sup>297</sup> ANL at 56; see also Reuters, "China's graphite curbs will accelerate plans around alternatives," October 23, 2023. Accessed on December 16, 2023 at <https://www.reuters.com/business/autos-transportation/chinas-graphite-curbs-will-accelerate-plans-around-alternatives-2023-10-20>, and Korea Economic Daily, "EV battery makers' silicon anode demand set for take-off" (February 2024) at <https://www.kedglobal.com/batteries/newsView/ked202402230020>.

The national security implications for all the mineral supply chains discussed previously in this section are examined further in section II.D.2.c.ii.c of this preamble. EPA posits that, if critical material availability were the type of profound constraint voiced by some commenters, one would expect there would be signs of trepidation in the amount of invested capital. However, we see the opposite, as demonstrated by ANL and outside analysis. At proposal, we cited one analysis indicating that 37 of the world's automakers are planning to invest a total of almost \$1.2 trillion by 2030 toward electrification, a large portion of which will be used for construction of manufacturing facilities for vehicles, battery cells and packs, and materials, supporting up to 5.8 terawatt-hours of battery production and 54 million electric vehicles per year globally.<sup>300</sup> Similarly, an analysis by the Center for Automotive Research showed that a significant shift in North American investment is occurring toward electrification technologies, with \$36 billion of about \$38 billion in total automaker manufacturing facility investments announced in 2021 being slated for electrification-related manufacturing in North America, with a similar proportion and amount on track for 2022.<sup>301</sup> The State of California, in its public comments, documented that as of March 2023, "at least \$45 billion in private-sector investment has been announced across the U.S. clean vehicle and battery supply chain."<sup>302</sup> Companies have announced over 1,300 GWh/year in battery production in North America by 2030.<sup>303</sup> Over \$100

<sup>298</sup> ANL at 52.

<sup>299</sup> EV battery makers' silicon anode demand set for take-off—KED Global <https://www.kedglobal.com/batteries/newsView/ked202402230020>.

<sup>300</sup> Reuters, "A Reuters analysis of 37 global automakers found that they plan to invest nearly \$1.2 trillion in electric vehicles and batteries through 2030," October 21, 2022. Accessed on November 4, 2022, at <https://graphics.reuters.com/AUTOS-INVESTMENT/ELECTRIC/akpeqgzypr>.

<sup>301</sup> Center for Automotive Research, "Automakers Invest Billions in North American EV and Battery Manufacturing Facilities," July 21, 2022. Retrieved on November 10, 2022 at <https://www.cargroup.org/automakers-invest-billions-in-north-american-ev-and-battery-manufacturing-facilities>.

billion of investment in domestic battery production has been announced in the past two years.<sup>304</sup>

Robust growth in the domestic battery supply chain, including mineral production, is spurred growth is furthered by the BIL and IRA. The IRA offers sizeable incentives and other support for further development of domestic and North American manufacture of electrified vehicles and components, and the BIL provides direct funding to achieve this same end. These two policies have already been transformative for the North American battery supply chain, as evidenced in Figure II-4: More recent information indicates that approximately 67 percent of private investments in North American battery manufacturing—including extraction of raw materials necessary for battery production, processing of these ores into battery-grade materials, manufacturing of midstream battery precursors, and production of battery cells and packs—has occurred in the past two years: as just noted, approximately \$100 billion of the \$150 billion invested since 2000.<sup>305</sup> Furthermore, there is a sizeable amount of funding from both BIL and IRA that still has not been allocated, with the expectation that the domestic battery supply chain will continue to grow as those funds are rolled out. Additional investments are likely upon the finalization of policies pertaining to the battery supply chain at the Department of Energy and the Department of the Treasury. Specifically, the BIL and IRA have introduced several incentives to scale domestic processing and recycling of critical minerals including the \$3 billion Battery Manufacturing and Recycling Grant Program, and tax credits including 45X and 48C.

<sup>302</sup> Comments of State of California at 30, citing U.S. Department of the Treasury, Treasury Releases Proposed Guidance on New Clean Vehicle Credit to Lower Costs for Consumers, Build U.S. Industrial Base, Strengthen Supply Chains (March 31, 2023), <https://home.treasury.gov/news/press-releases/jy1379>.

<sup>303</sup> Planned Battery Supply Fig. 10.

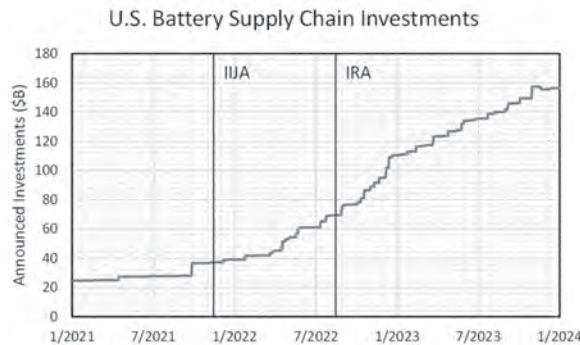

Figure II-4 Evolution of battery supply chain investments in the U.S. since 2021 (Planned Battery Supply Figure 2).

Beyond BIL and IRA, a number of actions underscore the extent of U.S. efforts to grow the domestic minerals supply chain, including extraction, processing, and recycling (detailed more extensively in the ANL critical minerals study). For example, critical minerals projects were recently made eligible for a streamlined permitting process under the Federal Permitting Improvement Steering Council (FAST-41) EXIM is supporting critical minerals projects in the U.S. and abroad through various financing products. The USGS Earth Mapping Resources Initiative (Earth MRI) is improving mapping and exploration of domestic resources across the country. USGS, DOD, and DOE are collaborating on a series of “hackathons” to leverage AI and machine learning to domestic critical minerals resource assessment. Efforts to secure global critical minerals supply chains are detailed further in section II.D.2.ii.c of this preamble. In addition to the efforts described previously in this section, the U.S. can increase minerals availability and minerals security by increasing domestic recycling and pursuing materials innovation and substitution.

Substantial funding to scale and improve recycling, as well as to develop advanced batteries using less or more readily abundant materials, is ongoing and will continue given the high importance of securing the minerals in question. Recycling is an important part of the solution to issues of mineral security and critical mineral availability. 88 FR 25969 and RTC section 4.7. Over the long term, battery recycling can effectively serve as a domestically produced mineral source that reduces overall reliance on foreign-sourced products. While growth in the return of end-of-life ZEV batteries will lag the market penetration of ZEVs due

to the long lifespan of EV batteries, we consider the ongoing development of a battery recycling supply chain during the time frame of the rule and beyond.

Battery recycling is an active area of research. The Department of Energy coordinates much research in this area through the ReCell Center, described as “a national collaboration of industry, academia and national laboratories working together to advance recycling technologies along the entire battery lifecycle for current and future battery chemistries.”<sup>306</sup> The ReCell Center is developing alternative, more efficient recycling methods that, if realized and scaled, can more efficiently expand recycled materials availability. These methods include direct recycling, in which materials can be recycled for direct use in cell production without destroying their chemical structure, and advanced resource recovery, which uses chemical conversion to recover raw minerals for processing into new constituents.<sup>307</sup> Battery recycling is the subject of several provisions of the BIL. It includes a Battery Processing and Manufacturing program, which grants significant funds to promote U.S. processing and manufacturing of batteries for electric vehicle and electric grid use, by awarding grants for demonstration projects, new construction, retooling and retrofitting, and facility expansion. It will provide a total of \$3 billion for battery material processing, \$3 billion for battery manufacturing and recycling, \$10 million for a lithium-ion battery recycling prize competition, \$60 million for research and development activities in battery recycling, an additional \$50 million for state and local programs, and \$15 million to develop a collection

system for used batteries. In addition, the Electric Drive Vehicle Battery Recycling and Second-Life Application Program will provide \$200 million in funds for research, development, and demonstration of battery recycling and second-life applications.<sup>308</sup> The DOE has announced the availability of \$37 million in funding to improve the economics and industrial ecosystem for battery recycling, and another \$30 million to enable a circular economy for EV batteries, to be awarded in 2024.<sup>309</sup>

Battery recycling is also a focus of private investment as a growing number of private companies are entering the battery recycling market. For example, Panasonic has contracted with Redwood Materials Inc. to supply domestically processed cathode material, much of which will be sourced from recycled batteries.<sup>310</sup> Ford and Volvo have also partnered with Redwood to collect end-of-life batteries for recycling and promote a circular, closed-loop supply chain utilizing recycled materials.<sup>311</sup> Redwood has also announced a battery active materials plant in South Carolina with capacity to supply materials for

<sup>307</sup> Department of Energy, “The ReCell Center for Advanced Battery Recycling FY22 Q4 Report,” October 20, 2022. Available at: <https://recellcenter.org/2022/12/15/recell-advanced-battery-recycling-center-fourth-quarter-progress-report-2022>.

<sup>308</sup> Environmental Defense Fund and ERM, “Electric Vehicle Market Update: Manufacturer Commitments and Public Policy Initiatives Supporting Electric Mobility in the U.S. and Worldwide,” September 2022.

<sup>309</sup> Department of Energy, Grants Notice: Bipartisan Infrastructure Law (BIL) FY23 BIL Electric Drive Vehicle Battery Recycling and Second Life Applications. Available online: <https://arpa-e.energy.gov/news-and-media/press-releases/us-department-energy-announces-30-million-develop-technologies-enable>.

<sup>310</sup> Randall, T., “The Battery Supply Chain Is Finally Coming to America,” Bloomberg, November 15, 2022.

<sup>304</sup> Planned Battery Supply at 4.

<sup>305</sup> Planned Battery Supply at 4. ANL has

100 GWh per year of battery production, and is likely to provide these materials to many of the “battery belt” factories that are developing in a corridor between Michigan and Georgia.<sup>312</sup> General Motors and LG Energy Solution have partnered with Li-Cycle to recycle GM’s Ultium cells.<sup>313 314</sup> Aqua Metals has developed a hydrometallurgical closed loop process capable of recovering all critical minerals with fewer associated emissions than pyrometallurgical processes.<sup>315</sup> Estimates vary for projections of recycling’s ability to meet demand for minerals. According to one estimate, by 2050, battery recycling could be capable of meeting 25 to 50 percent of total lithium demand for battery production.<sup>316 317</sup>

b. Production Capacity for Batteries and Battery Components

As described in the previous section, battery manufacturing consists of

<sup>310</sup> Randall, T., “The Battery Supply Chain Is Finally Coming to America,” Bloomberg, November 15, 2022.

<sup>311</sup> Automotive News Europe, “Ford, Volvo join Redwood in EV battery recycling push in California,” February 17, 2022. <https://europe.autonews.com/automakers/ford-volvo-join-redwood-ev-battery-recycling-push-california>.

<sup>312</sup> Wards Auto, “Battery Recycler Redwood Plans \$3.5 Billion South Carolina Plant,” December 27, 2022. <https://www.wardsauto.com/print/388968>.

<sup>313</sup> General Motors, “Ultium Cells LLC and Li-Cycle Collaborate to Expand Recycling in North America,” Press Release, May 11, 2021. <https://news.gm.com/newsroom.detail.html/Pages/news/us/en/2021/may/0511-ultium.html>.

<sup>314</sup> Other companies engaged in recycling of lithium ion batteries and other critical minerals include (and are not limited to) Umicore, Battery Solutions, RecycLi Battery Materials, American Battery Technology, and Glencore International.

several distinct stages. This section examines the outlook for the “midstream” of the lithium-ion battery supply chain, which includes materials processing, component manufacturing, and cell fabrication, in light of anticipated demand as a result of the final standards. While other battery chemistries exist or are under development, this section focuses on supply chains for lithium-ion batteries given their wide use and lack of near-term alternatives.

In the proposal, we examined the outlook for U.S. and global battery manufacturing capacity for vehicle lithium-ion batteries and compared it to our projection of U.S. battery demand under the proposed standards, considering demand of both the proposed HDV and LMDV proposed rules. 88 FR 25967. We collected and reviewed a number of independent studies and forecasts,<sup>318</sup> including numerous studies by analyst firms and various stakeholders, as well as a study of announced North American cell and battery manufacturing facilities compiled by Argonne National Laboratory (ANL) and assessments by the Department of Energy. Our review of these studies included consideration of uncertainties of the sort that are common to any forward-looking analysis but did not identify any constraint that indicated that global or domestic battery manufacturing capacity would be insufficient to support battery demand under the proposed standards. The review

<sup>315</sup> Aqua Metals. Available online: <https://aquametals.com>.

indicated that the industry was already showing a rapidly growing and robust response to meet current and anticipated demand, that this activity was widely expected to continue, and that the level of U.S. manufacturing capacity that had been announced to date was largely sufficient to meet the demand projected under the proposed standards by 2030. 88 FR 25968. We assessed that battery manufacturing capacity was not likely to pose a limitation on the ability of manufacturers to meet the standards as proposed.

EPA has carefully considered the substantive and detailed comments offered by the various commenters. In light of additional information that EPA has collected through continued research and the public comments, the evidence continues to support our previous assessment that domestic and global battery manufacturing is well positioned to deliver sufficient battery production to allow manufacturers to meet the standards.

The additional information EPA has collected addresses many of the points raised by the commenters. In particular, ANL has performed an updated assessment of North American battery components and cell manufacturing capacity that further reinforces our assessment that capacity is rapidly growing. EPA considers ANL’s assessment through December 2023 to be thorough and up to date.

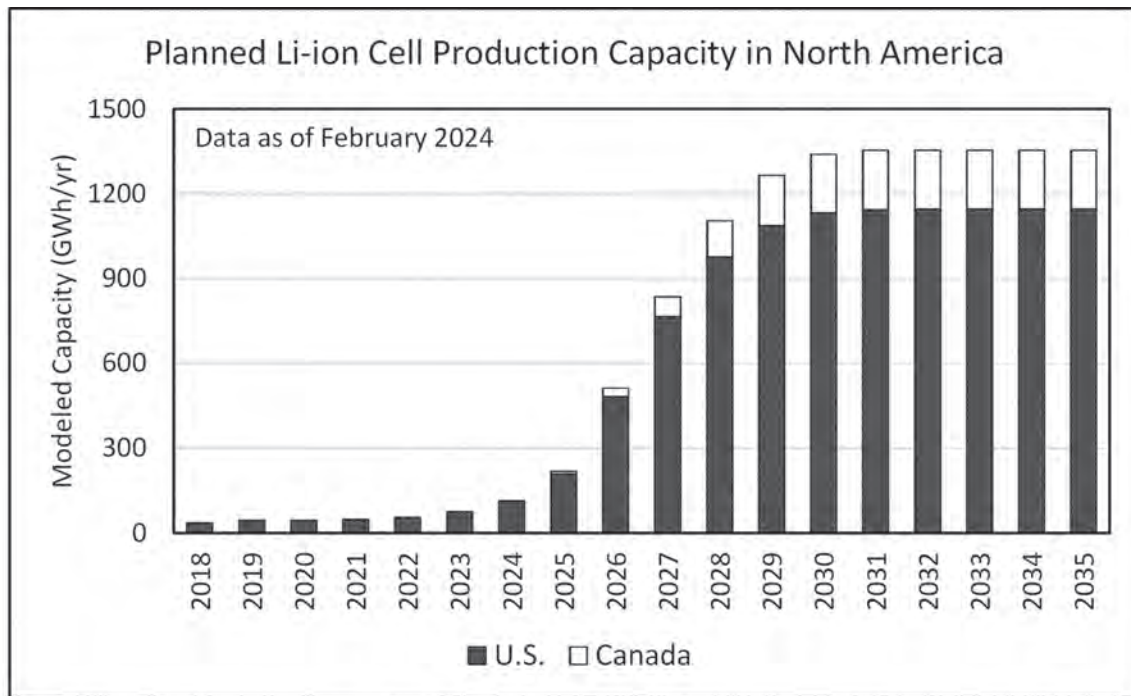

Figure II-5 Modeled lithium-ion cell production capacity in North America from 2018 to 2035 by country (Planned Battery Supply Fig. 7).

Based on announced investments in battery cell production, companies have announced over 1,300 GWh/year in battery production in North America by 2030 (Figure II-5). This is already a significant increase over the estimates discussed in the proposal of 1,000 GWh/year commencing in 2030. 88 FR 25967. EPA estimates that 11 GWh will be required for HDV BEVs in 2027 and 58 GWh in 2032 under the modeled potential compliance pathway. See RIA Chapter 2.10.2. Consequently, although most of this announced capacity is currently intended for light duty

vehicles (and some for stationary sources),<sup>319</sup> EPA finds that there is sufficient North American battery production capacity for HDVs within the rule’s timeframe, and ANL projects at least 45 GWh of announced cell production will be dedicated to HDV BEVs by 2030 (Figure II-6). Moreover, end use for some battery cell manufacturing facilities has not been announced, and it is likely that North American capacity can service HDV applications in greater than announced amounts. Importantly, in addition to the 13 new domestic battery plants we

projected to become operational in the four years from proposal, 88 FR 25986, the new work performed by ANL indicates that even more battery production capacity has been announced since the release of those previous reports (Figure II-7). In addition, capacity from trade allies is another source of supply: the sum of announced battery cell production capacity in MSP countries (outside North America) exceeds the sum in North America, with both reaching 1,300 GWh/year by 2030.<sup>320</sup> See Figure II-9 below.

<sup>316</sup> Sun et al., “Surging lithium price will not impede the electric vehicle boom,” *Joule*, doi:10.1016/j.joule.2022.06.028 (<https://dx.doi.org/10.1016/j.joule.2022.06.028>).

<sup>317</sup> Ziemann et al., “Modeling the potential impact of lithium recycling from EV batteries on

lithium demand: a dynamic MFA approach,” *Resour. Conserv. Recycl.* 133, pp. 76–85. <https://doi.org/10.1016/j.resconrec.2018.01.031>.

<sup>318</sup> U.S. Electric Vehicle Battery Manufacturing on Track to Meet Demand. EDF. December 2023. Available Online: <https://www.edf.org/sites/default/>

<files/2023-12/EDF%20Analysis%20on%20US%20Battery%20Capacity%2012.13.23%20final%20v3.pdf>.

<sup>319</sup> Planned Battery Supply at 22, 23.

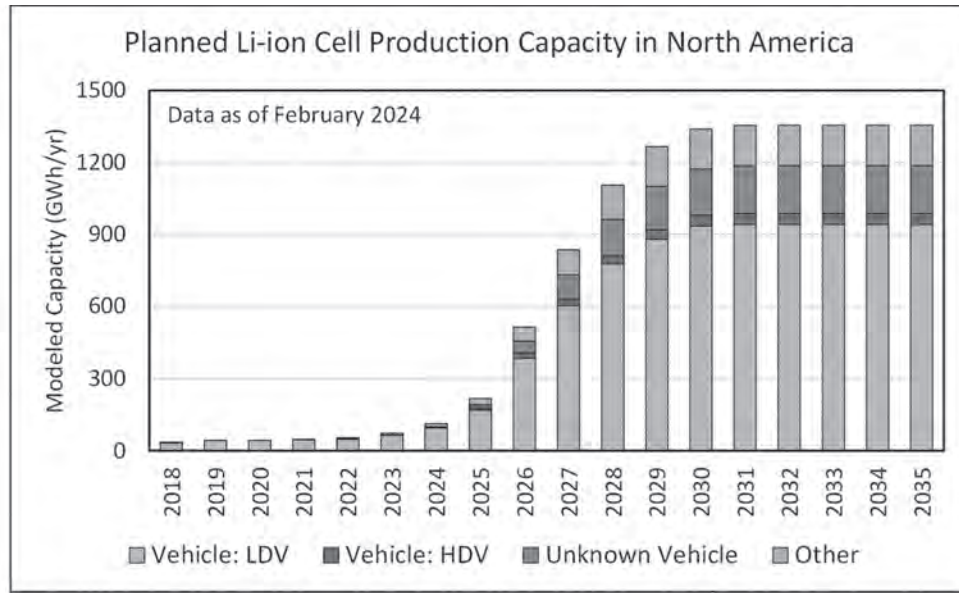

Figure II-6 Modeled lithium-ion cell production capacity in North America from 2018 to 2035 by transportation sector (Planned Battery Supply Figure 16).

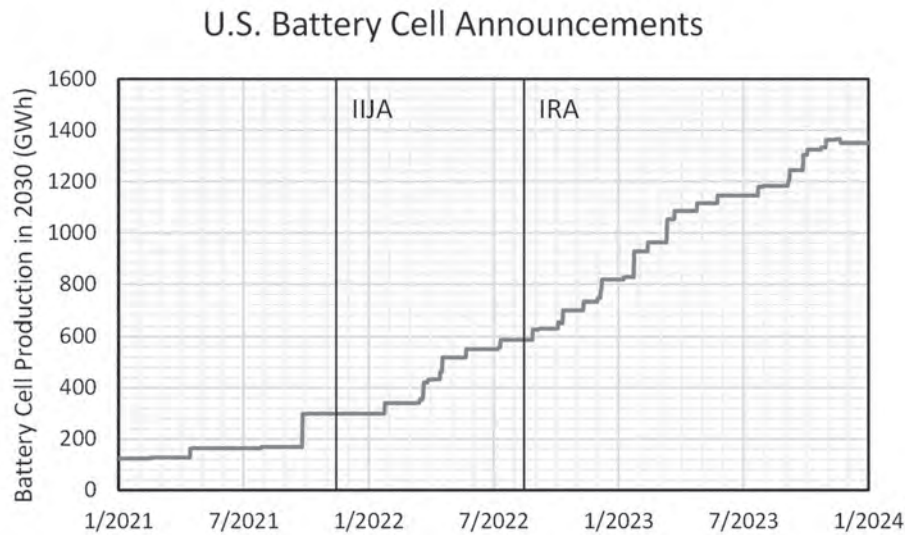

Figure II-7 Evolution in battery cell production announcements in North America (Planned Battery Supply Figure 11).

A number of comments expressed concerns regarding ramp-up time. The latest ANL projections estimate the period from announcement to beginning of production for each individual plant based on numerous factors, and uses a baseline estimate of 3 years from beginning of production to full scale operation, based on historical cell manufacturing data.<sup>321</sup> ANL describes this as “a modestly conservative estimate,” acknowledging that plants

could reach nominal capacity more quickly or more slowly. This estimate is consistent with the projections of significant increases in domestic production by the commencement of the Phase 3 program shown in the immediately preceding figures.

We also continue to see evidence that global lithium-ion battery cell production is growing rapidly<sup>322</sup> and is

likely to keep pace with increasing global demand. In the proposal we noted a 2021 report from Argonne National Laboratory (ANL)<sup>323</sup> that examined the state of the global supply chain for electrified vehicles and included a comparison of recent projections of future global battery

[www.iea.org/data-and-statistics/charts/lithium-ion-battery-manufacturing-capacity-2022-2030](http://www.iea.org/data-and-statistics/charts/lithium-ion-battery-manufacturing-capacity-2022-2030).

<sup>323</sup> Argonne National Laboratory, “Lithium-Ion Battery Supply Chain for E-Drive Vehicles in the United States: 2010–2020,” ANL/ESD–21/3, March 2021.

<sup>320</sup> Planned Battery Supply Appendix D.

<sup>322</sup> “Lithium-ion battery manufacturing capacity, 2022–2030”. International Energy Agency. Last updated May 22, 2023. Available Online: <https://www.iea.org>

manufacturing capacity and projections of future global battery demand from various analysis firms out to 2030, as seen in Figure II-8.<sup>324,325</sup> The three most recent projections of capacity (from BNEF, Roland Berger, and S&P Global in 2020–2021) that were collected by ANL at that time exceeded

the corresponding projections of demand by a significant margin in every year for which they were projected, suggesting that global battery manufacturing capacity is responding strongly to increasing demand.

The updated ANL supports the continuation of this trend. Figure II-9

shows projected battery cell production in MSP countries through 2035: as noted previously in this section, the sum of announced battery cell production capacity in MSP countries (outside North America) exceeds the sum in North America, with both reaching 1,300 GWh/year by 2030.

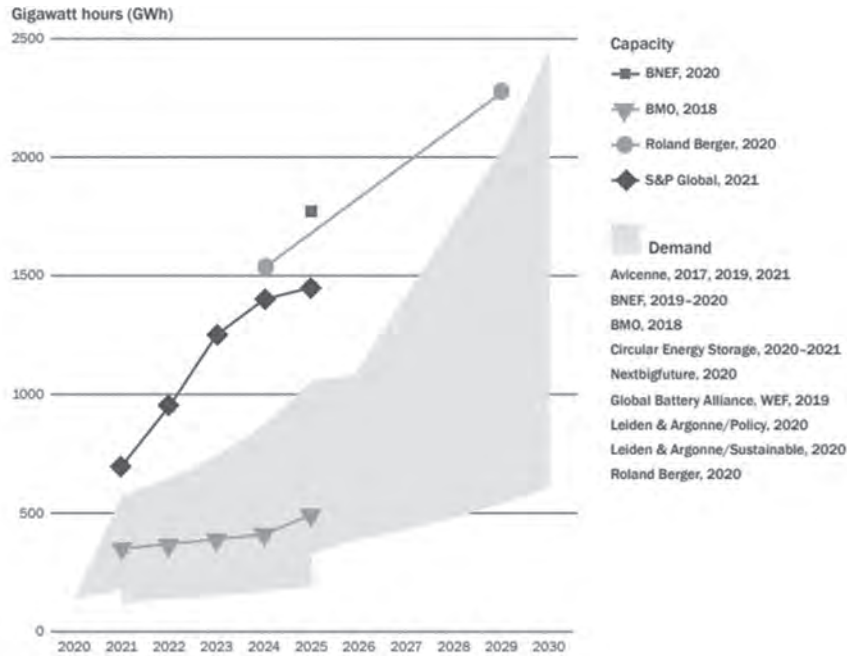

Figure II-8 Future global Li-ion battery demand and production capacity, 2020-2030 (ANL 2021).

<sup>324</sup> Argonne National Laboratory, “Lithium-Ion Battery Supply Chain for E-Drive Vehicles in the United States: 2010–2020,” ANL/ESD-21/3, March 2021.

<sup>325</sup> Federal Consortium for Advanced Batteries, “National Blueprint for Lithium Batteries 2021–2030,” June 2021 (Figure 2). Available at <https://www.energy.gov/sites/default/files/2021-06/>

*FCAB%20National%20Blueprint%20Lithium%20Batteries%200621\_0.pdf.*

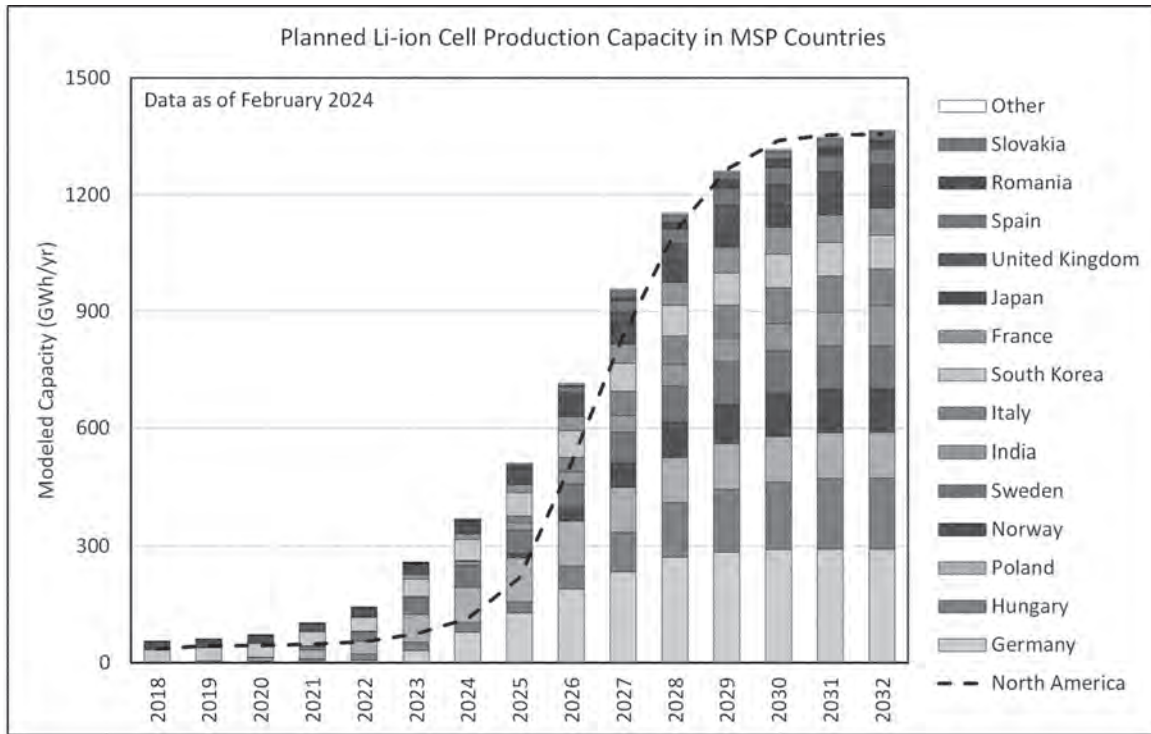

Figure II-9 Modeled MSP lithium-ion battery cell production capacity through 2035 (Planned Battery Supply Figure 55)

In addition to battery cell manufacturing, we also consider manufacturing of battery components. In order to meet their projected operating capacities, the North American battery plants will need to manufacture or purchase these materials. Battery components include electrode active material (cathode active

material CAM and anode active material AAM), electrolyte, foils, separators, and precursor materials, which include lithium carbonate, lithium hydroxide, nickel sulfate, cobalt sulfate, and manganese sulfate.

Figure II-10 repeats the chart that was shown in the proposal, showing preliminary projections of global cathode supply versus global cathode

demand, prepared by Li-Bridge for DOE,<sup>326</sup> and presented to the Federal Consortium for Advanced Batteries (FCAB)<sup>327</sup> in November 2022. These projections were largely derived by DOE from projections by BMI and indicate that global supplies of cathode active material (CAM) are expected to be sufficient through 2035.

<sup>326</sup> Slides 6 and 7 of presentation by Li-Bridge to Federal Consortium for Advanced Batteries (FCAB), November 17, 2022.

<sup>327</sup> <https://www.energy.gov/eere/vehicles/federal-consortium-advanced-batteries-fcab>.

Global cathode supply (Mt)

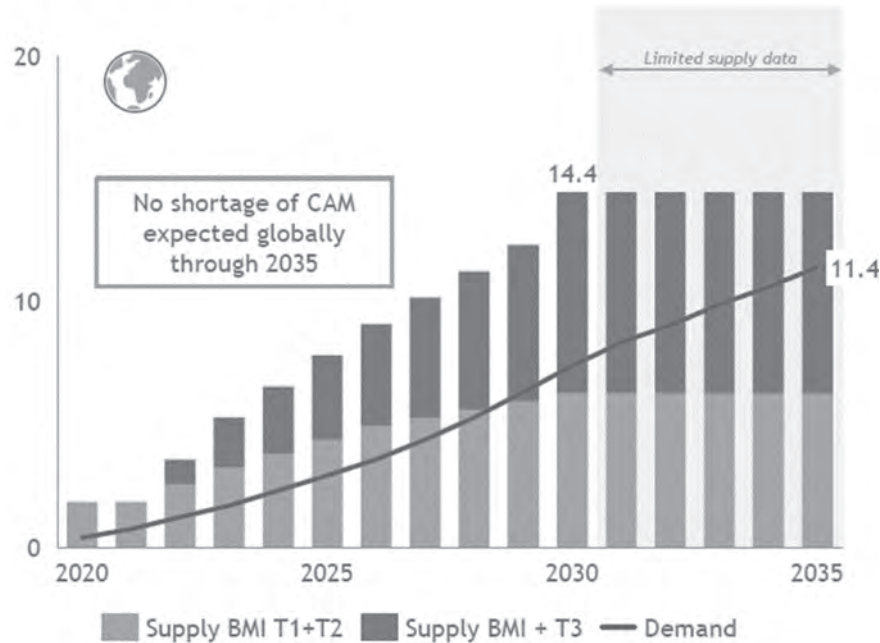

Figure II-10 DOE Li-Bridge assessment of global CAM supply and demand.

Following the proposal, ANL analyzed North American production capacity for battery components and precursor materials. ANL does project that some domestic demand will need to be satisfied through imports. Allies and partners outside of North America are likely to be integral in meeting U.S. battery component demand, though this does not indicate a deterrence to securing adequate battery components and precursor materials to meet domestic demand. Allies Japan and the Republic of Korea, for example, are the world’s second and third largest producers of CAM and AAM.<sup>328</sup>

Specifically, based on assessed announcements, ANL projects North American CAM production will reach 570 GWh by 2032, and that this will fall short of North American cell production by 2028.<sup>329</sup> Anode active material (AAM) is likewise projected to be primarily import dependent, with North American production capacity reaching 585 GWh in 2032; this would satisfy approximately 43 percent of forecast end demand in 2030 and remaining steady thereafter, with the remainder supplied from elsewhere.<sup>330</sup>

ANL emphasizes that its production projections are conservative and may understate domestic capacity, because

the analysis does not include plant announcements not formally announced, and because cell production or other facilities may be vertically integrated without this fact being disclosed.<sup>331</sup> In fact, planned or considered but not formally announced plants for AAM would add enough capacity to meet projected cell production.<sup>332</sup> Another reason any projected shortfall can be remedied is that CAM and AAM production have a one- to- three year timeframe from initial announcement and opening, faster than cell production plants. Thus, “[b]ecause of their shorter construction and permitting time, most battery components can be responsive to the demand arising from battery cell plants” and can delay announcement building commitment while waiting for certainty in cell production.<sup>333</sup> Gaps in supply may also be satisfied by imports.<sup>334</sup>

This outlook is informed by efforts to build a secure, and largely domestic, supply chain for battery components and batteries by the U.S. government and industry. The IRA and BIL have already provided and continue to provide significant support to accelerate

these efforts to build out a U.S. supply chain for batteries, and, as demonstrated in section II.D.2.c.ii.a of this preamble, uptake from industry has been considerable. As described in some detail earlier, the IRA offers sizeable incentives and other support for further development of domestic and North American manufacture of electrified vehicles and components, and BIL offers significant grant funding for battery component and cell manufacturing. The 45X tax credit offers up to \$35/kWh for battery cell production, up to \$10/kWh for battery pack production, and up to 10 percent of incurred costs for battery component production through 2032. The 48C tax credit offers up to \$10 billion in products that could include battery component and cell manufacturing and recycling. The DOE Loan Programs Office (LPO) is supported battery component and cell manufacturing projects through the Advanced Technologies Vehicle Manufacturing (ATVM) and Title 17 programs.<sup>335</sup> (Some examples of recent projects are outlined in RIA Chapter 1.5.1.3.) Together, these provisions are continuing to motivate manufacturers to invest in the continued development of a North American supply chain, and already appear to have proven influential on the plans of manufacturers to procure domestic or North American mineral and

<sup>328</sup> <https://iea.blob.core.windows.net/assets/4eb8c252-76b1-4710-8f5e-867e751c8dda/GlobalSupplyChainsofEV Batteries.pdf>

<sup>329</sup> Planned Battery Supply at 33–34.

<sup>330</sup> Planned Battery Supply at 30–31.

<sup>331</sup> Planned Battery Supply at 6 n.3, 31, 34.

<sup>332</sup> The report identifies an additional 590 GWh/year in nominal anode active material North American production capacity by the end of this decade which is planned or considered, but not formally announced. Planned Battery Supply at 31.

<sup>333</sup> Planned Battery Supply at 34, 31.

<sup>334</sup> Planned Battery Supply at 31, 34.

<sup>335</sup> Planned Battery Supply at 8.



component sources and to construct domestic manufacturing facilities to claim the benefits of the act. Manufacturers are investing in lithium-ion battery cell production, both independently and through joint ventures with battery companies. Tesla,

Ford, Volkswagen, GM, Stellantis, Honda, and Hyundai have all announced battery supply chain investments in North America.<sup>336</sup> See also preamble section II.E.4 for further discussion and examples. Importantly, while the effects of BIL and IRA on the

battery supply chain are well documented throughout this preamble, funds from these laws are still being disbursed, with billions of dollars available for the battery supply chain remaining (see Table II-8).

BILLING CODE 6560-50-P

**Table II-8 Summary of Select DOE Funding for Battery and Electric Vehicle Supply Chain**

Program	Funding Allocated <sup>a</sup>	Total Available <sup>b</sup>	Period of Availability	Project Examples
Battery Materials Processing Grants & Battery Manufacturing and Recycling Grants (MESC)	~\$1.9B	~\$4.1B	2022-2026; Until Expended <sup>c</sup>	CAM and AAM production, separator production, precursor materials production, battery cell production.
Domestic Manufacturing Conversion Grants (MESC)	\$0	\$2B	To remain available through 9/30/2031	Eligible projects include facilities to produce components for electric vehicles.
ATVM (LPO)	~\$15.9B	~\$49.8B	No restriction	Battery cell production, lithium carbonate production, AAM production, foil production, CAM production.
Title 17 (LPO)	\$398.6M	~\$60B	No restriction	Zinc bromine battery energy storage systems.
48C Qualifying Advanced Energy Tax Credit (IRS, MESC)	\$0	\$10B	Until expended	Eligible projects include production and recycling of clean energy technologies, critical minerals processing and recycling.
45X Advanced Manufacturing Production Tax Credit (IRS)	--	No limitation	For critical minerals: permanent; For other items: full credit available between 2023-29 with phase down from 2030-32	Eligible projects include battery components, critical minerals, inverters, components for solar and wind energy technology.

<sup>a</sup> Funding announced since 2021, as of February 2024, for projects related to the scope of this study (cells, packs, CAM, AAM, electrolyte, foil, separator, precursor materials). Includes conditional commitments (LPO only)

<sup>b</sup> For grants, the total available is the total allocated subtracted from the allocation, and indicates how much grant funding is left. For LPO, this number represents approximate loan authority available as of January 2024, reported by LPO.

<sup>c</sup> For the purposes of this table, the Battery Materials Processing Grants & Battery Manufacturing and Recycling Grants are combined. These two programs are authorized separately in the IIJA. Their periods of availability are listed respectively.

**BILLING CODE 6560-50-C**

In consideration of this updated information on battery component and cell manufacturing, it continues to be our assessment that the industry is well positioned to support the battery demand that is projected under the Phase 3 standards including taking into consideration uncertainties that generally accompany forward-looking projections, and therefore EPA concludes that there will be adequate

supply of battery cells and battery components to support the feasibility of the final standards under the modeled potential compliance pathway.

**c. Critical Mineral Security**

As stated at the beginning of this section II.D, it is our assessment that increased deployment of BEVs that could result from this final rule does not constitute a vulnerability to national security, for several reasons supported

by the discussion in this preamble and in RIA 1.5.1.2.

Mineral security refers to potential national security risks posed by vulnerabilities in the mineral supply chain, and in particular reliance on sourcing of critical minerals from countries with which the U.S. has fragile trade relations or significant policy differences. This section examines the outlook for mineral security as it relates to demand for

<sup>336</sup>Planned Battery Supply at 23.

critical minerals resulting from increased BEV production under the final standards. We note that this section focuses on mineral security, and not on energy security, which relates to security of energy consumed by transportation and other needs. Energy security is discussed separately in section VII.C of this preamble.

Concern for U.S. mineral security relates to the global distribution of established supply chains for critical minerals and the fact that, at present, not all domestic demand can be supplied by domestic production. Currently, despite a wide distribution of mineral resources globally, mineral production is not evenly distributed across the world. At present, production is concentrated in a few countries due to several factors, including where the resources are found in nature, the level of investment that has occurred to develop the resources, economic factors such as infrastructure, and the presence or absence of government policy relating to their exploitation. While the U.S. is not a leading producer of minerals used in BEV batteries at present, substantial investment has already gone towards expanding domestic mineral supply, largely due to funding and incentives from BIL and IRA. This is described in greater detail in section II.D.2.ii.a of this preamble.

In the proposal, EPA analyzed the primary issues surrounding mineral security as it relates to critical mineral needs for BEV production. 88 FR 25968. We collected and reviewed information relating to the present geographical distribution of developed and known critical mineral resources and products, including information from the U.S. Geological Survey, analyst firms and various stakeholders. In considering these sources we highlighted and examined the potential for the U.S. supply chain to reduce dependence on critical minerals that at present are largely sourced from other countries. Our assessment of the available evidence indicated that the increase in BEV production projected to result from the proposed standards could be accommodated without causing harm to national security.

EPA has carefully considered the substantive and detailed comments offered by the various commenters. Much of the information provided by adverse commenters builds upon the evidence that EPA already presented in the proposal concerning the risks and uncertainties associated with the future impact of mineral demand on mineral security. Much of the information provided by supportive commenters also builds on the evidence EPA

presented in the proposal about the pace of activity and overall outlook for buildout of the critical mineral supply chain. While contributing to the record, the information provided by the commenters largely serves to support the trends that were already identified and considered by EPA in the proposal, and do not identify new, specific aspects of mineral security that were not already acknowledged. Taken together, the totality of information in the public record continues to indicate that development of the critical mineral supply chains is proceeding both domestically and globally in a manner that supports the industry's compliance with the final standards under the modeled potential compliance pathway. In light of this information provided in the public comments and additional information that EPA has collected through continued research, it continues to be our assessment that the increase in ZEV production projected under the modeled potential compliance pathway for the standards is not expected to adversely impact national security, and in fact may result in national security benefits by reducing the need for imported petroleum (as discussed separately in section VII.C of this preamble) and providing regulatory and market certainty for the continued development of a domestic supply chain for critical minerals.

Regarding the adequacy of the supply chain in supporting the standards, EPA notes that it is a misconception to assume that the U.S. must establish a fully independent domestic supply chain for critical minerals or other inputs to BEV production in order to contemplate standards that may result in increased manufacture of BEVs. The supply chain that supports production of consumer products, including ICE vehicles, is highly interconnected across the world, and it has long been the norm that global supply chains are involved in providing many of the products that are commonly available in the U.S. market and that are used on a daily basis. As with almost any other product, the relevant standard is not complete domestic self-sufficiency, but rather a diversified supply chain that includes not only domestic production where possible and appropriate but also includes trade with allies and partners with whom the U.S. has good trade relations. As discussed below, bilateral and multilateral trade agreements and other arrangements (such as defense agreements and various development and investment partnerships), either long-standing or more recently established, already exist which greatly

expands opportunities to develop a secure supply chain that reaches well beyond the borders of U.S.

As discussed previously in this section in connection with critical mineral availability, since the proposal, Argonne National Laboratory has conducted additional analysis on the outlook for U.S. production of nickel, cobalt, graphite, manganese and lithium and we have updated our analysis to reflect this work. For the minerals examined, there are prospects for growth among secure sources of supply, and the report details ongoing efforts to build and strengthen partnerships with friendly countries to fill any supply gaps that cannot be met domestically.

The United States is actively pursuing a whole-of-government strategy to secure materials that cannot be sufficiently produced domestically. This involves diversifying sourcing strategies through strengthening current trade agreements and actively building new economic, technology, and regional security alliances. The United States has international initiatives in place to secure nickel, cobalt, and graphite, the critical battery minerals for which imports from non-FTA, non-MSP countries are projected in the short, medium, and/or long term. These initiatives and agreements serve to secure supply chains, and to balance and counteract influence of potential threats to those supply chains, including potential threats posed by Foreign Entities of Concern, such as the concentration of mineral processing in China. We discuss below some specific examples of bilateral and multilateral efforts to secure minerals supply from non-U.S. sources.

Indonesia, for example, is a major source of nickel supply and refining capacity, and also has significant reserves of cobalt. The U.S. has been making concerted efforts to forge a strong partnership with Indonesia, culminating in the U.S. entering into a Comprehensive Strategic Partnership with Indonesia in 2023, with the intention of creating a clean nickel supply chain. Another avenue for building partnership with Indonesia is through the Indo-Pacific Framework for Prosperity (IPEF), an agreement between the U.S. and countries across the Indo-Pacific region to advance resilience, sustainability, inclusiveness, economic growth, fairness, and competitiveness for our economies.<sup>337</sup> IPEF recently announced a critical minerals dialogue, and the IPEF Supply Chain Agreement

<sup>337</sup> <https://ustr.gov/trade-agreements/agreements-under-negotiation/indo-pacific-economic-framework-prosperity-ipef>.



fluctuating prices are relevant to critical minerals as well, but the impacts of such disruptions are felt differently and by different parties. Disruptions in oil supply or gasoline price have an immediate impact on consumers through higher fuel prices and thus constrains the ability to travel. In contrast, supply disruptions or price fluctuations of minerals affect only the production and price of new vehicles. In practice, short-term price fluctuations do not always translate to higher production cost as most manufacturers purchase minerals via long-term contracts that insulate them to a degree from changes in spot prices. Moreover, critical minerals are not a single commodity but a number of distinct commodities, each having its own supply and demand dynamics, with many being capable of substitution by other minerals.<sup>347</sup> Importantly, while oil is consumed as a fuel and thus requires continuous supply, minerals become part of the vehicle and have the potential to be recovered and recycled. Thus, even when minerals are imported from other countries, their acquisition adds to the domestic mineral stock that is available for domestic recycling in the future.

We thus reiterate our conclusion from proposal that there are short-term, medium-term, and long-term means of successfully dealing with issues of mineral security—both mineral availability and supply chains for the acquisition of minerals. Lithium supply in the mid- and long-term will largely be satisfied domestically, with supply gaps being filled by countries with which the U.S. has strong relations. Although we do not anticipate domestic supply to meet a large share of demand for cobalt, nickel, and graphite, we have indicated pathways by which a diversified and secure global supply chain for each may be achieved, describing a portfolio of bilateral and multilateral development efforts underway as of February 2024 to secure critical minerals from friendly countries, as described in the DOE Argonne Laboratory report on critical minerals availability. We anticipate these minerals security efforts to continue to expand subsequent to this final rulemaking. We consequently regard the Phase 3 standards as feasible in light of concerns regarding mineral security.

<sup>347</sup> For example, manganese can be substituted by aluminum in the case of nickel-manganese-cobalt (NMC) and nickel-cobalt-aluminum (NCA) batteries. Likewise, an LFP battery uses iron phosphate chemistry without nickel, manganese, cobalt or aluminum. Research has also been conducted to study the replacement of lithium with sodium ions.

iii. Assessment of Heavy-Duty BEV Charging Infrastructure

As BEV adoption grows, more charging infrastructure will be needed to support the HD BEV fleet.<sup>348</sup> We received many comments on this topic. Vehicle manufacturers, dealers, fleet owners, and representatives of the fuels industry among others raised concerns that charging and supporting infrastructure, both front-of-the-meter (electricity generation, distribution, and transmission) and back-of-the-meter (such as EVSE installations), is inadequate today and that the pace of deployment is not on track to meet levels projected if the proposed standards are finalized. Commenters noted that fleets will not buy, or may cancel orders, if charging infrastructure is a barrier. A particular concern raised by commenters is that although back-of-the-meter issues (e.g., how many EVSE ports to purchase, where to install EVSE, etc.) are largely in the control of the vehicle purchaser, front-of-the-meter issues are not. Commenters noted that if infrastructure is needed to support the EVSE hardware—generally termed distribution grid buildout—liaison with a utility is necessary. In this regard, many commenters spoke of a conundrum whereby owners will not purchase a BEV without assurance of adequate supporting infrastructure, but utilities will not build out without advance assurance of demand.

We also received comments from non-governmental organizations, electrification groups, electric vehicle manufacturers, and utilities indicating that there could be adequate supporting infrastructure, including distribution grid buildout, within the proposed Phase 3 rule's timeframe. They pointed out that buildout need not occur nationwide, nor all at once. Rather, they noted that initial buildout could be concentrated in a relatively few high-volume freight corridors. They also highlighted the many public and private investments in charging infrastructure that have been announced or are underway. Commenters flagged innovative charging solutions such as charging-as-a-service and mobile charging that can help meet the needs of fleets that experience delays installing EVSE or for which there are other barriers to depot charging. Some noted that public charging needs will be geographically concentrated in early years, allowing a phased approach for

<sup>348</sup> Infrastructure includes both charging infrastructure, which includes the EVSE on the customer side of the meter, and grid infrastructure, that is the power generation, transmission, and distribution on the utility side of the meter.

public infrastructure deployment. Finally, commenters noted that EPA finalizing stringent standards would provide certainty to OEMs, EVSE providers and utilities and spur further investments in charging infrastructure.

One point on which we received many comments was that there would need to be public charging to support the Phase 3 standards under the modeled potential compliance pathway. In this regard, the first group of commenters raised issues about the adequacy and availability of public charging networks. They noted that HD BEVs have different charging needs from LD vehicles, and that the power levels and site designs of public charging stations available today may not be able to serve HD vehicles. While some of these commenters noted the importance of public investments in charging infrastructure, they expressed concern that programs such as the \$5 billion National Electric Vehicle Infrastructure (NEVI) program established under the BIL will primarily support infrastructure designed for LD vehicles. The second group of commenters were optimistic that a sufficient public charging network was feasible within the 2027–2032 time frame, and some of these commenters provided quantified information as to potential network extent and cost in support.

We note at the outset that we agree with the commenters regarding the need to assess and cost public charging corresponding to the modeled potential compliance pathway supporting feasibility of the final standards. EPA's potential compliance pathway at proposal posited that all HDV charging needs could be met with depot charging, and EPA's cost estimates consequently reflected depot charging only. DRIA at 195. EPA acknowledged at proposal that public charging would ultimately be necessary, DRIA at 195–96, and now agrees with commenters that the need is nearer-term and that analysis of public charging should be included as part of the modeled potential compliance pathway that supports the feasibility of the final standards. Accordingly, the analysis for the final rule reflects incorporation of public charging for certain HDV subcategories starting in MY 2030. We have made the appropriate modifications to our cost estimates, and to HD TRUCS, to reflect public charging needs in the modeled potential compliance pathway. Further details are in sections II.D.5.iv, II.E.2, and II.E.5.i.

## a. Depot Charging

## (1) Behind-the-Meter Infrastructure

In both the NPRM and here in the final rule, we expect that much of the infrastructure development may be purchased by individual BEV or fleet owners for depot charging or be subject to third-party contracts to provide charging as a service.<sup>349</sup> Manufacturers are working closely with their customers to support this type of EVSE infrastructure, many making recent announcements since the NPRM was issued.

For example, PACCAR sells a range of EVSEs to customers directly.<sup>350</sup> Mack Trucks partnered with two charging solution companies so that they can offer customers the ability to acquire EVSE solutions directly from their dealers.<sup>351</sup> DTNA also announced a partnership to provide their customers with EVSE solutions.<sup>352</sup> Similarly, Navistar partnered with Quanta Services, Inc. to provide BEV infrastructure solutions, that include support in the design, construction, and maintenance of EVSE at depots.<sup>353</sup> Nikola has partnered with ChargePoint to provide fleet customers with a suite of options for charging infrastructure and software (e.g., for charge management).<sup>354</sup> AMPLY Power, which was acquired by BP in 2021, provides charging equipment and services for a

variety of fleets, including van, truck, and bus fleets.<sup>355</sup>

Some companies are starting with mobile charging units while they test or pilot vehicles.<sup>356</sup> For example, PACCAR has partnered with Heliox to offer 40 kW and 50 kW mobile charging units to its dealers and customers of the Kenworth and Peterbilt brands,<sup>357</sup> and Sysco, which plans to deploy 800 Class 8 BEV tractors in the next few years, plans to use mobile charging units to begin their truck deployments while 14 charging stations are being installed.<sup>358</sup>

While we agree with commenters that dedicated HD charging infrastructure may be limited today, we expect both depot and public charging to expand significantly over the next decade. The U.S. government is making large investments in charging infrastructure through the BIL<sup>359</sup> and the IRA,<sup>360</sup> as discussed in RIA Chapter 1.3.2. For example, the Charging and Fueling Infrastructure Discretionary Grant Program (CFI Program) recently announced the first-year grant recipients under the program.<sup>361</sup> In total, over \$600 million in grants will support the deployment of charging and alternative fueling infrastructure in communities and along corridors in 22 states (see RTC 6.1 for a summary of grants that will specifically support HD charging infrastructure). The IRA extends and modifies the “Alternative Fuel Refueling Property Credit” tax credit

under section 30C of title 26 of the Internal Revenue Code (“30C”) that could cover up to 30 percent of the costs for procuring and installing charging infrastructure (subject to a \$100,000 per item cap) in eligible census tracts through 2032. Based on its assessment of the share of heavy-duty charging stations that may be located in qualifying areas (and other 30C provisions), DOE projects an average value of this tax credit of 18 percent of the installed EVSE costs at depots and up to 27 percent<sup>362</sup> at public charging stations.<sup>363 364</sup> In addition, there are billions of dollars in funding programs that could support HD charging infrastructure either on its own or alongside the purchase of a HD BEV. As detailed in the following sections, private investments will also play an important role in meeting future infrastructure needs. We also agree with commenters that the existence of the final standards themselves provides regulatory certainty that will spur further infrastructure investments—both by HD vehicle purchasers installing EVSE at depots and by manufacturers, utilities, EVSE providers, and others installing public charging stations.

EVSE for HD BEVs is available today for purchase. However, EPA recognizes that it takes time for individual or fleet owners to develop charging site plans for their facility, obtain permits, purchase the EVSE, and have it installed. For the depots that may be charging a greater number of vehicles or with high-power DCFC ports, an upgrade to the electricity distribution system may be required adding to the installation timeline. As described in RIA Chapter 2.10.3, we estimated the total number of EVSE ports that will be required to support the depot-charged BEVs in the potential compliance pathway’s technology packages developed to support the MYs 2027–2032 standards. We estimated about 520,000 EVSE ports will be needed across all six model years, but only about half of those will be required to support the MY 2027 through MY 2030 vehicles. The majority (88 percent) of EVSE ports (for MY2027–2032) are Level 2 ports, which are less likely to require lengthy upgrades to the distribution system as described in

<sup>349</sup> “EV charging as a service”. IRENA—International Renewable Energy Agency. Accessed February 23, 2024. Available online: <https://www.irena.org/Innovation-landscape-for-smart-electrification/Power-to-mobility/31-EV-charging-as-a-service>.

<sup>350</sup> PACCAR. “Electric Vehicle Chargers.” Accessed on November 1, 2023. Available online: <https://www.paccarparts.com/technology/ev-chargers>.

<sup>351</sup> Volvo Group Press Release. “Mack Trucks Enters Partnerships with Heliox, Gilbarco to Increase Charging Accessibility.” February 14, 2023. Available online: <https://www.volvogroup.com/en/news-and-media/news/2023/feb/mack-trucks-enters-partnerships-with-heliox-gilbarco-to-increase-charging-accessibility.html>.

<sup>352</sup> Daimler Trucks North America Press Release. “Electrada, Daimler partner for electric charging.” October 3, 2023. Available online: <https://www.truckpartsandservice.com/alternative-power/battery-electric/article/15635568/electrada-daimler-partner-for-chargers>.

<sup>353</sup> Navistar Press Release. “Navistar Partners With Infrastructure Solutions Provider Quanta Services.” May 3, 2023. Available online: <https://news.navistar.com/2023-05-03-Navistar-Partners-With-Infrastructure-Solutions-Provider-Quanta-Services>.

<sup>354</sup> Nikola. “Nikola and ChargePoint Partner to Accelerate Charging Infrastructure Solutions.” November 8, 2022. Available online: [https://nikolamotor.com/press\\_releases/nikola-and-chargepoint-partner-to-accelerate-charging-infrastructure-solutions-212](https://nikolamotor.com/press_releases/nikola-and-chargepoint-partner-to-accelerate-charging-infrastructure-solutions-212).

<sup>355</sup> BP. Press Release: “bp takes first major step into electrification in the US by acquiring EV fleet charging provider AMPLY Power”. December 7, 2021. Available online: <https://www.bp.com/en/global/corporate/news-and-insights/press-releases/bp-takes-first-major-step-into-electrification-in-us-by-acquiring-ev-fleet-charging-provider-amply-power.html>.

<sup>356</sup> Mobile charging units are EVSE that can move to different locations to charge vehicles. Depending on the unit’s specifications and site, mobile charging units may be able to utilize a facility’s existing infrastructure (e.g., 240 V wall outlets) to recharge. Mobile charging units may have wheels for easy transport.

<sup>357</sup> Hampel, Carrie. “Heliox to be global charging partner for Paccar”. *Electrive.com*. September 24, 2022. Available online: <https://www.electrive.com/2022/09/24/heliox-to-be-global-charging-partner-for-paccar/>.

<sup>358</sup> Morgan, Jason. “How Sysco Corp. plans to deploy 800 battery electric Class 8 trucks (and that’s just the beginning)”. *Fleet Equipment*. November 14, 2022. Available online: <https://www.fleetequipmentmag.com/sysco-battery-electric-trucks>.

<sup>359</sup> Infrastructure Investment and Jobs Act, Public Law 117–58, 135 Stat. 429 (2021). Available online: <https://www.congress.gov/117/plaws/publ58/PLAW-117publ58.pdf>.

<sup>360</sup> Inflation Reduction Act, Public Law 117–169, 136 Stat. 1818 (2022). Available online: <https://www.congress.gov/117/plaws/publ169/PLAW-117publ169.pdf>.

<sup>361</sup> JOET, “Biden-Harris Administration Bolsters Electric Vehicle Future with More than \$600 Million in New Funding.” January 11, 2024, <https://drivelectric.gov/news/new-cfi-funding>.

<sup>362</sup> The average value of 27 percent for public charging infrastructure is for EVSE under 1 MW; for 1 MW and higher, DOE estimates an average tax credit value of 19 percent.

<sup>363</sup> U.S. DOE, “Estimating Federal Tax Incentives for Heavy Duty Electric Vehicle Infrastructure and for Acquiring Electric Vehicles Weighing Less than 14,000 Pounds.” Memorandum, March 2024.

<sup>364</sup> See preamble section II.E.2 and RIA Chapter 2.6.2.1 for a discussion of how we accounted for this tax credit in our analysis of depot EVSE costs.

section II.E.2. See also RTC section 7 (Distribution). In conclusion, there is time to install EVSE at depots to support projected utilization of BEV technologies beginning in MY 2027.

(2) Front-of-the-Meter Infrastructure/ Distribution Grid Buildout

EPA has carefully considered the many comments concerning the need for, timing of, and cost for distribution

grid buildout.<sup>365</sup> This issue relates to the infrastructure linking transmission lines to an electricity user. A typical grid infrastructure diagram shows a transmission line feeding into a distribution substation which serves several feeders to distribute power. From the feeders that serve thousands of customers, the service transformers step down the voltage to customer utilization levels. Of these three elements of

distribution grid infrastructure, the substation is by far the costliest and most time-intensive to construct (though less so to upgrade an existing substation), feeders are the next most resource intensive, and service transformers the least. Table II–9, based on information in RIA Chapter 1.6.5, shows timing estimates for each of these elements.<sup>366 367</sup>

Table II-9 Timing to Implement Electricity Distribution Components

Component	Capacity per Borlaug et al. 2021	Time to Implement (months)	
		Borlaug et al. 2021	EPRI
Substation New	3 – 10+ MW	24–48	36–60
Substation Upgrade	3 – 10+ MW	12–18	24–36
Feeder New	5+ MW	3–12	12–24
Feeder Upgrade	5+ MW	3–12	6–12
Transformer New	200+ kW	3–8	3–8

New substation costs can vary, depending on location (urban/suburban/rural) and Megavolts ampere with estimates showing \$4 to \$35 million.<sup>368</sup> Feeders can cost from \$100 to approximately \$872 per foot, variables being above or below ground installation, and voltage (typically \$1 million for 0 kV–25 kV and \$1.5 million for 26kV–35kV).<sup>369</sup> The estimated cost of a non-DCFC service transformer is \$20,000.<sup>370</sup>

EPA has assessed the question of how much buildout might be needed (under the modeled potential compliance pathway supporting the feasibility of the standards) at the national level, at the regional level, and at the parcel level.<sup>371</sup> Assessment was conducted with EPA internal tools<sup>372</sup> as well as with a first of its kind ground up analysis from DOE. We find that electricity demand attributable to the Phase 3 standards under the modeled potential compliance pathway is minimal for any and all of these perspectives, and especially so in the initial years of the program when the lead time needed for distribution grid buildout installation

could potentially otherwise be constraining.

In 2027, the Phase 3 rule is projected to increase transportation sector electricity demand by a modest 0.67 percent; that is, of the national demand for electricity posed by the transportation sector, less than 1 percent is attributable to the Phase 3 rule in 2027. In 2032, this rule is projected to increase transportation sector electricity demand to 9.27 percent.<sup>373</sup> We note that the modeling associated with these estimates uses the final rule adoption rate scenario, which corresponds to the modeled potential compliance pathway for the final rule.

Furthermore, since this demand is only that attributable to the transportation sector, the demand as a percentage of total demand on a utility would be less, since it would be a fraction of all other sources of demand. Thus, in 2030 and 2035 (the years we modeled for this analysis), increases in the demand for the modeled compliance pathway are only 0.41 percent and 2.59 percent.<sup>374</sup>

Moreover, as commenters noted (see RTC sections 6.1 and 7 (Distribution)),

charging infrastructure needed to meet this demand in the time frame of the rule is likely to be centered in a sub-set of states and counties where freight activity is concentrated and supportive ZEV policies exist. ICCT found that likely areas of high concentration include Texas (Harris, Dallas, and Bexar counties); southern California (Los Angeles, San Bernadino, San Diego and Riverside counties); New York State (Bronx, New York, Queens, Kings, and Richmond counties); Massachusetts (Suffolk county); Pennsylvania (Philadelphia county); New Jersey (Hudson county); and Florida (Miami-Dade county).<sup>375</sup> These areas are projected to experience either higher aggregate demand or higher energy demand per unit area attributable to HD BEV adoption. In the critical initial year of the Phase 3 standards, when there is the least lead time, EPA’s projected increases in electricity demand are very modest, ranging from 0.002 percent (Los Angeles-Long Beach-Anaheim) to 0.88 percent (Phoenix-Mesa-Scottsdale).<sup>376</sup>

These estimates are conservative. The projected increases represent increased electricity demand attributable to both

<sup>365</sup> See, RTC section 7 (Distribution) for a full discussion of the issues discussed in this preamble section; see also RIA Chapter 1.6.

<sup>366</sup> Borlaug, B., Muratori, M., Gilleran, M. et al. “Heavy-duty truck electrification and the impacts of depot charging on electricity distribution systems”. *Nat Energy* 6, 673–682 (2021). Available online: <https://www.nature.com/articles/s41560-021-00855-0>.

<sup>367</sup> EPRI. “EVs2Scale2030TM Grid Primer”. August 29, 2023. Available online: <https://www.epri.com/research/products/000000003002028010>.

<sup>368</sup> Borlaug, B., Muratori, M., Gilleran, M. et al. “Heavy-duty truck electrification and the impacts of depot charging on electricity distribution systems”. *Nat Energy* 6, 673–682 (2021). Available online:

<https://www.nature.com/articles/s41560-021-00855-0>.

<sup>369</sup> National Renewable Energy Laboratory, Lawrence Berkeley National Laboratory, Kevala Inc., and U.S. Department of Energy. “Multi-State Transportation Electrification Impact Study: Preparing the Grid for Light-, Medium-, and Heavy-Duty Electric Vehicles”. DOE/EE–2818. U.S. Department of Energy. March 2024. At 64–65 (“TEIS”).

<sup>370</sup> TEIS at 96. Median cost of DCFC service transformers in the Study was \$50,000. Id.

<sup>371</sup> A “parcel”, as used in the TEIS, means “a real estate property or land and any associated structures that are the property of a person with identification for taxation purposes.” TEIS at 2 n. 15.

<sup>372</sup> See discussion of IPM modeling for the interim control case described in RIA Chapter 4.2.4.

<sup>373</sup> Murray, Evan “Calculations of the Impacts of the Final Standards at Various Geographic Scales” (February 29, 2024). (National Demand tab).

<sup>374</sup> Murray, Evan “Calculations of the Impacts of the Final Standards at Various Geographic Scales” (February 29, 2024). (Generation National Demand tab).

<sup>375</sup> Comments of ICCT, July 2023 at 11. These comments reflect Ragon, Kelly, et al., 2023 (“ICCT May 2023 White Paper”).

<sup>376</sup> Murray, Evan “Calculations of the Impacts of the Final Standards at Various Geographic Scales” (February 29, 2024). (MSA Demand tab).

the heavy-duty Phase 3 rule and demand from the light-duty sector absent the final rule. The portion of electricity demand attributable to the Phase 3 rule would be less.

We estimate that electricity demand in these high traffic freight corridors attributable to the transportation sector would increase in 2032, corresponding to need under the modeled potential compliance pathway to meet increased standard stringency (including standards for sleeper cab tractors and heavy heavy-duty vocational vehicles which commence after MY 2027, ranging from 0.014 percent (San Diego-Carlsbad) to 12.58 percent (San Antonio-New Braunfels).<sup>377</sup> EPA regards these projected increases as modest. The projected increases in 2027, when there is the shortest lead time for buildout, are small. As expected, demand is projected to increase in 2032 but there is considerably more available lead time in which buildout can be accommodated. Moreover, these increases are modest compared to total electricity demand on utilities within the states in these freight corridors. See RTC section 7 (Distribution).

The Department of Energy study, “Multi-State Transportation Electrification Impact Study” (“TEIS”) supports this conclusion at a more granular level.<sup>378</sup> This is the first study of this scale to be bottom up, comparing parcel level light, medium, and heavy-duty vehicle demand to parcel supply by PV (photovoltaic) and grid capacity at each examined parcel. The study focuses on 5 states (California, New York, Illinois, Oklahoma, and Pennsylvania) selected to capture diversity in population density (urban and rural areas), freight demand, BEV demand, state EV policies, utility type (*i.e.*, investor owned, municipality, or cooperative) and distribution grid composition. The TEIS used these states to extrapolate a national demand for where and when upgrades will be needed to the electricity distribution system—including substations, feeders, and service transformers—due to BEV load under the approximated combination of the EPA’s combined light-duty and medium-duty rulemaking action (LMDV)<sup>379</sup> and HD Phase 3 rules

and under a no action case. The research team also assessed the potential impact of managed EV charging at homes and depots to reduce the peak power needs and associated cost and timing of distribution upgrades. In the unmanaged case, the study assumes that EVs are charged immediately when the vehicle returns to a charger. In contrast, the managed charging case has vehicles arriving at charging locations and intentionally minimizing charging power such that the session is completed just prior to the vehicle’s departure from that location<sup>380</sup> The study also incorporates public charging such that the corresponding high power needs are reflected.

The study estimates overload at the substation level (100 percent criteria), feeder level (100 percent criteria), and at the residential service transformer per feeder level (125 percent) criteria.<sup>381</sup> Scenarios examined are for 2027 “no action” (*i.e.*, baseline without the LMDV or HD Phase 3 emission standards under the two rulemakings) with and without mitigation (*i.e.*, the EV charging management just described), and the action case with EPA’s LMDV and HD Phase 3 rules, again both with and without mitigation. The action case uses the same case EPA used for its national and regional estimates presented previously in this section, which include higher electricity demand than corresponds to the HD Phase 3 final standards under the modeled potential compliance pathway. The study examines the same scenarios for 2032.<sup>382</sup>

Consistent with the national demand and high freight corridor regional demand estimates, the TEIS projects minimal demand (energy consumption) and minimal peak demand for both 2027 and 2032, even without considering any mitigation. In 2032, that incremental increase ranged from 1.6 percent to 2.7 percent.<sup>383</sup> Incremental impact on peak demand, again from the unmanaged case, was 0.1–0.2 percent in 2027 and 0.6–3.0 percent in 2032.<sup>384</sup>

If BEV users engage in simple management strategies—shifting charging times as described previously

in this section<sup>385</sup>—not only do these estimates of energy consumption and peak demand impacts decrease, but in some instances, peak demand is projected to *decrease* in absolute terms, that is, to be less than in the no action unmanaged case. Thus, for 2027, incremental peak demand *decreases* in four of the five states, and remains identical in the fifth.<sup>386</sup> For 2032, incremental peak demand is positive in two of the states but the increase is only 0.1 percent and 0.5 percent, and *reduced* in the other states by 0.5–1.8 percent potentially obviating the need for any buildout at all.<sup>387</sup>

These minor increases reflect low numbers of transformers, feeders, and substations estimated to be needed (again, for the five states at issue, and for both LMDV and HD Phase 3 rules together). In 2027, only 1 additional substation is projected to be needed, and none in the managed case.<sup>388</sup> In 2032, the TEIS projects that only 8 substations would be needed in the unmanaged case, 4 if conservative mitigative measures are utilized.<sup>389</sup> Projections for feeders are 9 in 2027 (5 in the managed case), and 125 in 2032 (75 if managed). In 2027, the TEIS projects 2,800 transformers (2,400 if managed), and 30,000 in 2032 (21,000 in the managed case).<sup>390</sup>

Although new substations are a significant undertaking that can take multiple years as shown in Table II–9, as noted, the TEIS finds that only a small number are projected to be needed. We note further that the estimates in the TEIS Study of the amount of distribution buildout needed are conservative with respect to the HD Phase 3 rule. First, the TEIS Study considered both the light/medium duty standards and the HD Phase 3 emission standards together and did not disaggregate the results. Second, as just noted, the action scenario considered included higher electricity demand than corresponds to the Phase 3 final standards under the modeled potential compliance pathway. Third, the “unmanaged” scenario presented considers no mitigation efforts at all. If minimal mitigation efforts, characterized in the TEIS as “a conservative estimate of the benefits of managed charging”,<sup>391</sup> are considered

<sup>377</sup> Murray, Evan “Calculations of the Impacts of the Final Standards at Various Geographic Scales” (February 29, 2024). (MSA Demand tab).

<sup>378</sup> National Renewable Energy Laboratory, Lawrence Berkeley National Laboratory, Kevala Inc., and U.S. Department of Energy. “Multi-State Transportation Electrification Impact Study: Preparing the Grid for Light-, Medium-, and Heavy-Duty Electric Vehicles”. DOE/EE–2818. U.S. Department of Energy. March 2024. (“TEIS”).

<sup>379</sup> EPA’s combined light-duty and medium-duty rulemaking action “Multi-Pollutant Emissions

Standards for Model Years 2027 and Later Light-Duty and Medium-Duty Vehicles” Docket ID: EPA–HQ–OAR–2022–0829. We refer to this action both as the Light- and Medium-Duty (LMDV) rule and/or LD rule for short in this preamble.

<sup>380</sup> TEIS at 4.

<sup>381</sup> TEIS at 47 (substation), 47 (feeder), and 49 (transformer).

<sup>382</sup> TEIS at 2–3. The No Action case includes current state and Federal policies and regulations as of April 2023. *Id.* at 3.

<sup>383</sup> TEIS at 56.

<sup>384</sup> TEIS at 62.

<sup>385</sup> TEIS at 4.

<sup>386</sup> TEIS at 62.

<sup>387</sup> TEIS at 62.

<sup>388</sup> TEIS at Table ES–2.

<sup>389</sup> TEIS at Table ES–2.

<sup>390</sup> TEIS at Table ES–2. Compare this with the estimated 50 million transformers in use presently. See RTC section 7 (Distribution).

<sup>391</sup> TEIS at 4.

estimated impacts decrease sharply. The action managed case is projected to *reduce* peak loads in all 5 States in 2027, and to reduce peak loads in 3 of the 5 States in 2032.

We further have modeled a potential compliance pathway whereby almost all of the HD BEVs utilize Level 2 or DC–50 kW chargers for depot EVSE, rather than higher rated chargers.<sup>392</sup> These lower rated chargers will not pose the types of electricity demand potentially requiring distribution buildout upgrades as the higher-rated chargers posited by some of the commenters.<sup>393</sup>

EPA recognizes that from the standpoint of timing, it is important to consider not only incremental increases in demand attributable to the HD Phase 3 emission standards but also other demand from the light-duty, medium-duty, and heavy-duty transportation sector that might occasion the need for distribution grid buildout. For example, buildout potentially could be needed with respect to HD BEVs in the EPA reference case. We continue to find that this overall demand can be accommodated within the timeframe of the rule, for the following reasons.

As discussed previously in this section, buildout need not occur everywhere and all at once. In the rule’s time frame, as shown in particular in the ICCT 2023 White Paper, it can be centered in a discrete number of high freight corridors.

In the early model years of the program, when lead time is the shortest, projected demand remains low.<sup>394</sup> When accounting for the increase from all vehicles (light-duty and heavy-duty), we find the portion of demand attributable to the entire heavy-duty vehicle sector (including ACT) increases by only 2.6 percent between 2024 and 2027.<sup>395</sup> That is, the increase in demand attributable specifically to electric heavy-duty vehicles (including ACT), and therefore the infrastructure buildout necessary to support those vehicles, is small compared to other factors.

We further project that a substantial majority of these ACT-compliant ZEVs

would be light and medium heavy vocational vehicles which utilize EVSE types least likely to occasion demand triggering need for buildout. RIA Chapter 4.2.2. For example, the TEIS projects no need for new and upgraded substations in 2027 nationally, and need for only approximately 24–48 (managed and unmanaged cases) nationally in 2032.<sup>396</sup>

Most of the demand comes from the states which have adopted ACT.<sup>397</sup> EPA notes that these states that have adopted the program have undertaken and have on-going efforts to achieve it. See RTC section 7 (Distribution) describing such on-going efforts.

With respect to non-ACT states, most of the demand in these states is attributable to the HD Phase 3 rule itself. See RIA Chapter 4.2.2. As discussed in RTC section 7 (Distribution) with respect to high freight corridors in non-ACT states (including Pennsylvania, Texas, Arizona, and Illinois), that incremental demand is low, especially in the initial year of the program. State-by state results show similar small percentages of increased demand.<sup>398</sup>

EPA agrees with this assessment from the Energy Strategy Coalition (speaking for some of the nation’s largest investor-owned electric and gas utilities, public power authorities and generators of electricity): “[d]emand for electricity will increase under both the HDV Proposal and recently-proposed multi-pollutant standards for light-duty and medium-duty vehicles . . . but the electricity grid is capable of planning for and accommodating such demand growth and has previously experienced periods of significant and sustained growth.”<sup>399</sup> We further note the comments of the Edison Electric Institute (trade association of the nation’s investor-owned utilities) (“EEI”) that the degree of anticipated buildout is similar to increases experienced historically by the utility industry, and can be accommodated within the HD Phase 3 rule’s timeframe. EEI Comments at 7, 8. The Analysis Group reached a similar conclusion.<sup>400</sup>

Some commenters were concerned that interactions with utilities and their regulatory commissions vary state-by-state, and that this regime adds to grid buildout deployment timing difficulties.<sup>401</sup> Other commenters, however, persuasively maintained that this localized system is actually a plus, because each potential buildout is a localized decision, best handled by the local utility and grid operator.<sup>402</sup> As discussed further below, there are also many mitigative measures which BEV users can utilize to reduce demand, and the localized process could provide a means of developing local site optimized mitigative measures.

Finally, we expect that the HD Phase 3 rule itself will serve as a strong signal to the utility industry to make proactive investments and otherwise proactively analyze and plan for potential buildout needs.<sup>403</sup>

Commenters pointed out that “at the distribution system level it is not sufficient to simply compare potential charging station demand growth to system capacities.”<sup>404</sup> Numerous commenters also pointed to a chicken-egg conundrum, whereby potential fleet purchasers contemplating BEVs will not purchase without an assurance of adequate electrical supply, but utilities cannot build out without having assurance of demand.

EPA believes that there are potential solutions to these issues. First, as demonstrated previously in this section, we have projected a potential compliance pathway to meet the final standards whereby there will be limited need for grid distribution buildouts. Those buildouts that we project largely involve transformers or feeders, and (in 2032) a handful of expanded substations. We emphasize again that this analysis is conservative in that we did not include ameliorative measures available to utilities to apportion demand (discussed below).

commissions, or electric companies, and there are long-standing policies and practices in place to ensure timely planning for and development of the infrastructure needed to endure system, reliability. And for most states and electric companies in the country. The magnitude and pace of system demand growth associated with the rollout of the EPA’s proposed phase 3 rule neither different from past periods of economically-driven demand growth, nor unusual with respect of the processes of forecasting, planning and development required.”)

<sup>401</sup> Comments of DTNA at 47; see also Comments of Environmental Defense Fund at 67.

<sup>402</sup> Comments of State of California at 29.

<sup>403</sup> See Comments of CATF at 48; Comments of EDF at 75; Comments of ICCT at 10; Comments of Moving Forward Network at 114.

<sup>404</sup> Analysis Group Heavy Duty Vehicle Electrification at 10.

<sup>392</sup> RIA chapter 2 at Table 2–73. The only exceptions are for four tractors projected to utilize DC–150kW chargers (HD TRUCS vehicles 30, 31, 83, and 101), and one additional tractor and one transit bus projected to utilize DC–350kW chargers (HD TRUCS vehicles 80 and 87).

<sup>393</sup> The ICCT White Paper likewise finds that “trucks with smaller batteries can charge overnight with 50 kW CCS chargers or 19 kW Level 2 chargers in some cases.” ICCT White Paper at p. 6.

<sup>394</sup> TEIS at 75 showing national distribution costs in 2027 (reflecting both light- and heavy-duty sectors).

<sup>395</sup> Murray, Evan, “Calculations of the Impacts of the Final Standards at Various Geographic Scales” (February 29, 2024).

<sup>396</sup> TEIS at 65 and using the TEIS analysis showing that the 5 states analyzed account for approximately one third of national costs (TEIS at 66).

<sup>397</sup> Murray, Evan “Calculations of the Impacts of the Final Standards at Various Geographic Scales” (February 29, 2024). (Demand by State tab).

<sup>398</sup> Murray, Evan “Calculations of the Impacts of the Final Standards at Various Geographic Scales” (February 29, 2024) (Demand by State tab).

<sup>399</sup> Comments of Energy Strategy Coalition, at pp. 1–2.

<sup>400</sup> Hibbard et al., “Heavy Duty Vehicle Electrification” (June 2023) at 27 (“Adding significant new distribution system infrastructure is not a new experience for states, public utility



Second, utilities can and are acting proactively to provide added capacity when needed. As stated by EEI, “EPA’s assessment that ‘there is sufficient time for the infrastructure, especially for depot charging, to gradually increase over the remainder of this decade to levels that support the stringency of the proposed standards for the timeframe they would apply’ is accurate. . . . As described previously in this section, EEI members actively are planning for and deploying infrastructure today”. EEI Comments at 14. EEI documents that a number of large utilities are finding ways to move away from a business model requiring demonstration of concrete demand so as to provide infrastructure readiness in advance of individual applications. EEI comments at 12–14 (actions of California and New York State investor-owned utilities, and their respective regulatory bodies); see RTC section 7 (Distribution) for additional examples. And as noted by the Energy Strategy Coalition (speaking for some of the nation’s largest investor-owned electric and gas utilities, public power authorities and generators of electricity): “[d]emand for electricity will increase under both the HDV Proposal and recently-proposed multi-pollutant standards for light-duty and medium-duty vehicles . . . but the electricity grid is capable of planning for and accommodating such demand growth and has previously experienced periods of significant and sustained growth.”<sup>405</sup>

Utilities, of course, are motivated to continue investment in the distribution system for reasons other than demand from the transportation sector, and so could be building out in some cases for their own purposes.<sup>406</sup> In addition, utilities themselves are pursuing innovative solutions to address the issue of needed buildout. One approach is for utilities to make non-firm capacity available immediately as they construct distribution system upgrades. See RTC 7 (Distribution) discussing Southern California Edison’s two-year Automated Load Control Management Systems pilot program which would limit new customers’ consumption during periods when the system is constrained while the utility completes needed upgrades providing those customers access to the distribution system sooner than would otherwise be possible.

Plans like Southern California Edison’s to use load management systems to connect new EV loads faster

in constrained sections of the grid will be bolstered by standards for load control technologies. UL, an organization that develops standards for the electronics industry, drafted the UL 3141 Outline of Investigation (OOI) for Power Control Systems (PCS). Manufacturers can use this standard for developing devices that utilities can use to limit the energy consumption of BEVs. With this standard in place and manufacturer completion of conforming products, utilities will have a clear technological framework available to use in load control programs that accelerate charging infrastructure deployment for their customers.<sup>407</sup>

Third, there are means for utilities to ameliorate demand which do not require regulatory approval. Utilities can engage in short-term load rebalancing by optimizing use of existing distribution infrastructure. This can accommodate new HDV demand while maintaining overall system reliability.<sup>408</sup> In addition, because depot charging often occurs over nighttime hours corresponding to reduced system demand, utilities have the flexibility to use otherwise extra grid capacity for those hours (excess capacity being inherent in constructing to nameplate capacity).<sup>409</sup> Utilities also can reduce needed demand by incorporating so-called smart charging into feeder ratings and load forecasting whereby the utility need not provide capacity based on annual peak load, but can differentiate by daily and seasonal times.<sup>410</sup> An available variant of this practice is use of flexible interconnections, whereby customers agree to limit their peak load to a specified level below the cumulative nameplate capacity of their equipment (in this case, their EVSEs) until associated grid upgrades can be completed, in order to begin operating any new needed charging infrastructure more quickly.<sup>411</sup>

Many utilities also provide hosting capacity maps. Utilities, developers, and other stakeholders can use these maps to better plan and site energy infrastructure. Hosting capacity maps provide greater transparency about where new loads such as EV chargers,

can be readily connected without triggering a need for significant grid upgrades. Specifically, hosting capacity maps identify where power exists and at what level, where distributed energy resources (DERs) can alleviate grid constraints, or where an upgrade may be required. For example, EV companies can use the maps to identify new areas to expand their charging station networks more quickly and cost-effectively. While the information in hosting capacity maps does not address all the interconnection questions for individual sites, they can indicate relative levels of investment needed.

Fourth, there are many mitigative measures open to fleet owners utilizing depots. Readily available practices include use of managed charging software, energy efficiency measures, and onsite battery storage and solar generation.<sup>412</sup> Hardware solutions include bi-directional charging and V2G (vehicle to grid) whereby vehicles can return electricity to the grid during peak hours while drawing at low demand times.<sup>413</sup> Solar DER allows on site electricity generation that reduces the energy demand on the grid. Battery-integrated charging can simplify and accelerate EVSE deployment and potentially lower costs by avoiding the need for grid upgrades and reducing demand charges. These charging stations are easier for electric utilities to serve on relatively constrained portions of the distribution system. These charging stations use integrated batteries to provide high-powered charging to customers and recharge by drawing power from the grid at much lower rates throughout the day. ANL’s study on battery-integrated charging shows that these systems can be deployed cost effectively for Class 1–3 BEV needs.<sup>414</sup> The use for LD BEV will at times eliminate the need for grid buildout, making that hardware available for HD BEV or other users that must have grid upgrades. While not a HD BEV analysis, the process can be applied to HD BEV to determine when this architecture provides value. Battery-integrated charging is commercially available and, for example, is being deployed across

<sup>407</sup> UL LLC, January 11, 2024. “UL 3141: Outline for Investigation of Power Control Systems.” Available online: [https://www.shopulstandards.com/ProductDetail.aspx?productId=UL3141\\_1\\_O\\_20240111](https://www.shopulstandards.com/ProductDetail.aspx?productId=UL3141_1_O_20240111).

<sup>408</sup> ICCT White Paper at 18–19.

<sup>409</sup> ICCT White Paper at 19.

<sup>410</sup> ICCT Comment at 12.

<sup>411</sup> Comments of EDF at 69; Electric Power Research Institute (EPRI), “Understanding Flexible Interconnection” (September 2018) (describing its possibilities for reducing demands on time—and location-dependent hosting capacity).

<sup>412</sup> Comments of EDF at 69.

<sup>413</sup> Comments of Advanced Energy United, EPA–HQ–OAR–2022–0985–1652–A2 at 4; Comments of Clean Air Task Force, EPA–HQ–OAR–2022–0985–1640–A1 at 54; Analysis Group Heavy Duty Vehicle Electrification at 33–4.

<sup>414</sup> Poudel, Sajag, Jeffrey Wang, Krishna Reddi, Amgad Elgowainy, Joann Zhou. 2024. Innovative Charging Solutions for Deploying the National Charging Network: Technoeconomic Analysis. Argonne National Laboratory.

<sup>405</sup> Comments of Energy Strategy Coalition, at pp. 1–2.

<sup>406</sup> TEIS at 99–100, noting the need to replace aging assets, and for scheduled maintenance.

multiple states.<sup>415</sup><sup>416</sup> All of these can reduce demand below what would otherwise be nameplate capacity. See the comment summaries in RTC section 7 discussion of distribution costs. Other innovative charging solutions can also accelerate EV charging deployment. Mobile chargers can be deployed immediately because they do not require an on-site grid connection. They can be used as a temporary solution to bring additional charging infrastructure to locations before a stationary, grid-connected charger can be deployed. Additional innovative charging solutions can further accelerate charging deployment by optimizing the use of chargers that have already been installed. One company, EVMatch, developed a software platform for sharing, reserving, and renting EV charging stations, which can allow owners of charging stations to earn additional revenue while making their chargers available to more EV drivers to maximize the benefit of each deployed charger.<sup>417</sup> This scenario could allow HD BEV depots to earn revenue off of their chargers while the HD BEV are on the road doing work. Innovative charging models like these can be efficient ways to increase charging access for EVs with a smaller amount of physical infrastructure. We note that EPA's cost estimates do not include consideration of these mitigative measures, since we project a compliance pathway without needing them. However, these are all available measures to reduce demand and need for distribution buildout, and consequently form part of our basis for determining that there are reasonable means of providing needed distribution buildout in the rule's timeframe when there is a need to do so.

A variety of solutions are being offered for, or explored by, fleets. For example, WattEV is planning a network of public charging depots connecting ports to warehouses and distribution centers as part of its "Truck-as-a-Service" model, in which customers pay a per mile rate for use of, and charging

for, a HD electric truck.<sup>418</sup> The first station under construction in Bakersfield, CA,<sup>419</sup> is planned to have integrated solar and eventually be capable of charging 200 trucks each day; additional stations are under development in San Bernardino and near the Port of Long Beach. Zeem Solutions also offers charging to fleets along with a lease for one of its medium- or heavy-duty BEVs (via its "Transportation-as-a-Service" model). Zeem's first depot station opened last year in the Los Angeles area and will support the charging of vans, trucks, airport shuttles, and tour buses (among other vehicles) with its 77 DCFC ports and 53 L2 ports.<sup>420</sup> As many commenters noted, the question of availability of supporting electrification infrastructure is not fully in the control of the regulated entity (here, the manufacturer), nor is it fully in the direct control of prospective vehicle purchasers. As all agree, this necessitates some measure of coordination between a range of stakeholders and utilities. Utilities have a strong business incentive to coordinate to meet increased demand and many such means of coordination are described in the comments by utility associations like EEI,<sup>421</sup> and the transportation industry coalition ZETA.<sup>422</sup>

In sum, we believe that distribution systems to meet the potential increase in charging station demand associated with depot charging under the HD Phase 3 rule will be available in the rule's timeframe. Quantified demand attributable to the rule is relatively modest, and, where buildout might be needed, can be met for the most part with the least time-intensive infrastructure buildout. We have also considered further potential issues, including the chicken-egg paradigm, and described means that are reasonably available to resolve them in the lead time provided by the rule. Utilities and fleets are already engaging in these practices. That the trade association of the investor-owned utility industry

agrees provides further support for our finding. Comments of Edison Electric Institute at 14. See also preamble section II.E.5.ii.

b. Public Charging

As noted earlier in this section, EPA has revised its projected potential compliance pathway from proposal such that sleeper cab tractors and certain day cab tractors are projected to utilize public charging networks<sup>423</sup> rather than depot charging. See generally, preamble section II.D.5. We find here that there will be adequate lead time for development of supporting public charging infrastructure for these tractors under the modeled potential compliance pathway for the final standards.

First, as documented in the ICCT 2023 White Paper, there is no need to build out all at once.<sup>424</sup> It is reasonable to project that activity will center on the busiest long-haul freight routes and corridors. The White Paper further finds that in 2030, up to 85 percent of charging infrastructure needs for long-haul trucks could be met by building stations on discrete corridors of the National Highway Freight Network where energy demand is concentrated. ICCT White Paper at 14. Assuming an average of 50 miles between stops, this would mean a need for 844 public charging stations. Id. In a supplemental analysis assuming 100-mile intervals between stations, ICCT refined that estimate to needing between 100–210 electrified truck stops, assuming a given level of BEV long-haul tractors.<sup>425</sup> We note that the ICCT estimates in both the White Paper and the Supplemental comment assume more long-haul BEV adoption than in EPA's projected compliance pathway for 2030, and so, from that standpoint, can be considered to be conservative bounding estimates.

In March 2024, the U.S. released a National Zero-Emission Freight Corridor Strategy<sup>426</sup> that, "sets an actionable

<sup>423</sup> En-route charging could occur at public or private charging stations though, for simplicity, we often refer to en-route charging as occurring at public stations.

<sup>424</sup> Ragon, et. al. "White Paper: Near-Term Infrastructure Deployment to Support Zero-Emission Medium- and Heavy-Duty Vehicles in the United States". The International Council on Clean Transportation. May 2023. Available online: <https://theicct.org/wp-content/uploads/2023/05/infrastructure-deployment-mhdv-may23.pdf>.

<sup>425</sup> ICCT. "Supplemental comments of the International Council on Clean Transportation on the EPA Phase 3 GHG proposal". January 3, 2024. Docket ID EPA-HQ-OAR-2022-0985-.

<sup>426</sup> Joint Office of Energy and Transportation. "National Zero-Emission Freight Corridor Strategy" DOE/EE-2816 2024. March 2024. Available at <https://driveelectric.gov/files/zef-corridor-strategy.pdf>.

<sup>415</sup> Blink. "Blink Charging Commissions First Battery Storage Energized DC Fast Charger in Pennsylvania Providing Off-Grid Charging Capabilities". May 16, 2023. Available online: <https://blinkcharging.com/news/blink-charging-commissions-first-battery-storage-energized-dc-fast-charger-in-pennsylvania-providing-off-grid-charging-capabilities>.

<sup>416</sup> Lewis, Michelle. "Texas trailblazes with DC fast chargers with integrated battery storage". Electrek. February 12, 2024. Available online: <https://electrek.co/2024/02/12/texas-dc-fast-chargers-integrated-battery-storage-xcharge-north-ameri>.

<sup>417</sup> EVmatch. Available online: <https://evmatch.com/>.

<sup>418</sup> WattEV. "WattEV Orders 50 Volvo VNR Electric Trucks". May 23, 2022. Available online: <https://www.wattev.com/post/wattev-orders-50-volvo-vnr-electric-trucks>.

<sup>419</sup> WattEV. "WattEV Breaks Ground on 21st Century Truck Stop". December 16, 2021. Available online: <https://www.wattev.com/post/wattev-breaks-ground-on-21st-century-truck-stop>.

<sup>420</sup> Business Wire. "Zeem Solutions Launches First Electric Vehicle Transportation-As-A-Service Depot." March 30, 2022. Available online: <https://www.businesswire.com/news/home/202203300005269/en/Zeem-Solutions-Launches-First-Electric-Vehicle-Transportation-As-A-Service-Depot>.

<sup>421</sup> Comments of EEI pp. 10–16.

<sup>422</sup> Comments of ZETA pp. 32–46.

vision and comprehensive approach to accelerating the deployment of a world-class, zero-emission freight network across the United States by 2040. The strategy focuses on advancing the deployment of zero-emission medium- and heavy-duty vehicle (ZE-MHDV) fueling infrastructure by targeting public investment to amplify private sector momentum, focus utility and regulatory energy planning, align industry activity, and mobilize communities for clean transportation.”<sup>427</sup> The strategy has four phases. The first phase, from 2024–2027, focuses on establishing freight hubs defined “as a 100-mile to a 150-mile radius zone or geographic area centered around a point with a significant concentration of freight volume (e.g., ports, intermodal facilities, and truck parking), that supports a broader ecosystem of freight activity throughout that zone.”<sup>428</sup> The second phase, from 2027–2030, will connect key ZEV hubs, building out infrastructure along several major highways. The third phase, from 2030–2045, will expand the corridors, “including access to charging and fueling to all coastal ports and their surrounding freight ecosystems for short-haul and regional operations.”<sup>429</sup> The fourth phase, from 2035–2040, will complete the freight corridor network. This corridor strategy provides support for the development of HD ZEV infrastructure that corresponds to the modeled potential compliance pathway for meeting the final standards.

This level of public charging is achievable. As described in RIA Chapter 1.3, the U.S. government is making large investments in charging infrastructure through the BIL and the IRA. For example, in the past year, over \$160 million in grants under the Charging and Fuel Infrastructure program were announced in the States of California, New Mexico, New York, and Washington for projects that will explicitly support HD charging.<sup>430</sup> (See

RTC section 6.1.) As described in RIA Chapter 1.6, heavy-duty vehicle manufacturers, charging network providers, energy companies and others are also investing in public or other stations that could support public charging. For example, Daimler Truck North America is involved in an initiative in the U.S. with electric power generation company NextEra Energy Resources and BlackRock Renewable Power to collectively invest \$650 million create a nationwide charging network for commercial electric vehicles.<sup>431</sup> They plan to start network construction in 2023 and by 2026 cover key routes on the East and West Coast and in Texas with a later stage of the project also supporting hydrogen fueling stations. DTNA is also working with the State of Michigan and DTE to develop a prototype truck stop charging station in Michigan that could serve as a model for broader truck stop deployment.<sup>432</sup> Volvo Group and Pilot recently announced their intent to offer public charging for medium- and heavy-duty BEVs at priority locations throughout the network of 750 Pilot and Flying J North American truck stops and travel plazas.<sup>433</sup> Tesla is developing charging equipment for their semi-trucks that will recharge up to 70 percent of the Tesla semi-truck’s 500-mile range in 30 minutes.<sup>434</sup>

Other investments will support regional or local travel needs. For example, Forum Mobility announced a \$400 million investment for 1,000 or more DCFCs for BEV trucks that are planned for operation at the San Pedro and Oakland ports.<sup>435</sup> Logistics and

supply chain corporation NFI Industries is partnering with Electrify America to install 34 DCFC ports (150 kW and 350kW) to support their BEV drayage<sup>437</sup> fleet that will service the ports of LA and Long Beach.<sup>438</sup> With funding from California, Volvo is partnering with Shell Recharge Solutions and others to deploy five publicly accessible charging stations by 2023 that will serve medium- and heavy-duty BEVs in southern California between ports and industrial centers.<sup>439</sup>

States and utilities are also engaged. Seventeen states plus the District of Columbia (and the Canadian province Quebec) developed a “Multi-State Medium- and Heavy-Duty Zero-Emission Vehicle Action Plan,” which includes recommendations for planning for, and deploying, charging infrastructure.<sup>440</sup> California is investing \$1.9 billion in state funding through 2027 in BEV charging and hydrogen fueling infrastructure (and related projects), including about one billion specific to infrastructure for trucks and buses.<sup>441</sup> The Edison Electric Institute estimates that electric companies are investing about \$4 billion to advance charging infrastructure and fleets.<sup>442</sup> The National Electric Highway Coalition, a group that includes more than 60 electric companies and cooperatives that serve customers in 48 states and DC,<sup>443</sup> aims to provide fast

Accelerating Buildout of EV Charging Networks.” February 15, 2023. Available online: <https://driveelectric.gov/news/private-investment>.

<sup>437</sup> Drayage trucks typically transport containers or goods a short distance from ports to distribution centers, rail facilities, or other nearby locations.

<sup>438</sup> Electrify America. “Electrify America and NFI Industries Collaborate on Nation’s Largest Heavy-Duty Electric Truck Charging Infrastructure Project.” August 31, 2021. Available online: <https://media.electrifyamerica.com/en-us/releases/156>.

<sup>439</sup> Borrás, Jo. “Volvo Trucks Building an Electric Semi Charging Corridor”. *CleanTechnica*. July 16, 2022. Available online: <https://cleantechnica.com/2022/07/16/volvo-trucks-building-an-electric-semi-charging-corridor/>.

<sup>440</sup> ZEV Task Force. “Multi-State Medium- and Heavy-Duty Zero-Emission Vehicle Action Plan: A Policy Framework to Eliminate Harmful Truck and Bus Emissions.” July 2022. Available online: <https://www.nescaum.org/documents/multi-state-medium-and-heavy-duty-zev-action-plan-dual-page.pdf>.

<sup>441</sup> California Energy Commission. “CEC Approves \$1.9 Billion Plan to Expand Zero-Emission Transportation Infrastructure”. February 14, 2024. Available online: <https://www.energy.ca.gov/news/2024-02/cec-approves-19-billion-plan-expand-zero-emission-transportation-infrastructure>.

<sup>442</sup> Joint Office of Energy and Transportation. “Private Sector Continues to Play Key Part in Accelerating Buildout of EV Charging Networks.” February 15, 2023. Available online: <https://driveelectric.gov/news/private-investment>.

<sup>443</sup> Edison Electric Institute. Issues & Policy: National Electric Highway Coalition. Available

2022–FY 2023 Grant Selections”. Available online: <https://highways.dot.gov/sites/fhwa.dot.gov/files/CFI%20Grant%20Awards%20Project%20Descriptions%20FY22-23.pdf>.

<sup>431</sup> NextEra Energy. News Release: “Daimler Truck North America, NextEra Energy Resources and BlackRock Renewable Power Announce Plans to Accelerate Public Charging Infrastructure for Commercial Vehicles Across The U.S.” January 31, 2022. Accessible online: <https://newsroom.nexteraenergy.com/news-releases?item=123840>.

<sup>432</sup> Daimler Trucks North America Press Release. “State of Michigan partners with Daimler Truck North America and DTE Energy to build Michigan’s “truck stop of the future.”” June 29, 2023. Available online: <https://northamerica.daimlertruck.com/pressdetail/state-of-michigan-partners-with-daimler-2023-06-29>.

<sup>433</sup> Adler, Alan. “Pilot and Volvo Group add to public electric charging projects”. *FreightWaves*. November 16, 2022. Available online: <https://www.freightwaves.com/news/pilot-and-volvo-group-add-to-public-electric-charging-projects>.

<sup>434</sup> Tesla. “Semi: The Future of Trucking is Electric.” Available online: <https://www.tesla.com/semi>.

<sup>435</sup> As noted by the Joint Office of Energy and Transportation in a summary of recent private sector investments in charging infrastructure.

<sup>436</sup> Joint Office of Energy and Transportation. “Private Sector Continues to Play Key Part in

<sup>427</sup> Joint Office of Energy and Transportation. “Biden-Harris Administration, Joint Office of Energy and Transportation Release Strategy to Accelerate Zero-Emission Freight Infrastructure Deployment.” March 12, 2024. Available online: <https://driveelectric.gov/news/decarbonize-freight>.

<sup>428</sup> Joint Office of Energy and Transportation. “National Zero-Emission Freight Corridor Strategy” DOE/EE–2816 2024. March 2024. Available at <https://driveelectric.gov/files/zef-corridor-strategy.pdf>. See page 3.

<sup>429</sup> Joint Office of Energy and Transportation. “National Zero-Emission Freight Corridor Strategy” DOE/EE–2816 2024. March 2024. Available at <https://driveelectric.gov/files/zef-corridor-strategy.pdf>. See page 8.

<sup>430</sup> U.S. Department of Transportation, Federal Highway Administration. “Federal Highway Administrations’ Charging and Fueling Infrastructure Discretionary Grants Program: FY

charging along major highways in their service areas. Other utilities, like the Jacksonville Electric Authority (JEA), are supporting infrastructure through commercial electrification rebates. JEA is offering rebates of up to \$30,000 for DCFC stations and up to \$5,200 for Level 2 stations.<sup>444</sup> In the west, Nevada Energy was supporting fleets by offering rebates for up to 75 percent of the project costs for Level 2 ports and up to 50 percent of the project costs for DCFC stations (subject to caps and restrictions).<sup>445</sup> <sup>446</sup> See generally RIA Chapter 1.6.2.

In sum, given the relatively low demand, ability to prioritize initial public charging deployment in discrete freight corridors, the extra lead time afforded for HDV applications projected to utilize public charging under the modeled potential compliance pathway, and the amount of public and private investment, EPA projects that the necessary public charging corresponding to the potential compliance pathway will be available within the lead time afforded by the HD Phase 3 final standards. We note further that we will continue to monitor the development of the HDV public charging infrastructure, as discussed in preamble section II.B.2.iii.

c. Associated Costs

The TEIS documents low overall financial impact associated with grid buildout. For 2027, the TEIS shows incremental distribution grid capital investment of \$195 million for the unmanaged action scenario. When managed, that \$195 million drops to \$82 million.<sup>447</sup> For 2032, the TEIS shows incremental distribution grid capital investment of \$2.3 billion for the unmanaged action scenario. When managed, the \$2.3 billion drops to \$1.6 billion.<sup>448</sup> The savings is driven by the reduction in peak incremental load achieved by the basic load management applied in this study. More effective load management is expected to be

online: <https://www.eei.org/en/issues-and-policy/national-electric-highway-coalition>.

<sup>444</sup> U.S. Department of Energy. Alternative Fuels Data Center. “Florida Laws and Incentives.” See Docket ID EPA-HQ-OAR-2022-0985-0290.

<sup>445</sup> Level 2 rebates are applicable to fleets with between 2 and 10 ports, and subject to a \$5,000/port cap. DCFC rebates are limited to 5 stations and are capped to the lesser of \$400/kW or \$40,000 per station.

<sup>446</sup> U.S. Department of Energy. Alternative Fuels Data Center. “Commercial Electric Vehicle (EV) Charging Station Rebates—Nevada Energy (NV Energy).” (Note: the program ended in June 2023.) Available online: <https://afdc.energy.gov/laws/12118>.

<sup>447</sup> TEIS at Table ES-2.

<sup>448</sup> TEIS at Table ES-2.

utilized in practice.<sup>449</sup> Incremental distribution grid investment to enable plug-in electric vehicle (PEV) charging (\$2.3 billion across five states over 6 years assuming unmanaged charging) was found to be approximately 3 percent of existing utility distribution system investments (2027–2032).<sup>450</sup>

We think this increase in distribution investment is modest and reasonable. Moreover, this value is conservative as it is inclusive of effects for both the light- and medium-duty vehicle standards and the heavy-duty Phase 3 rule and so overstates the amount of grid investment associated with the final rule, and as it does not reflect managed charging. The study finds that “[m]anaged charging techniques can decrease incremental distribution grid investment needs by 30 percent, illustrating the potential for significant cost savings by optimizing PEV charging and other loads at the local level.”<sup>451</sup> The managed charging practices analyzed in the TEIS are minimal and are characterized in the TEIS as “a conservative estimate of the benefits of managed charging.”<sup>452</sup> Given the very significant economic benefits of managed charging, we expect the market to adopt managed charging particularly under the influence of additional ZEV adoption associated with the modeled potential compliance pathway of the final rule.

We also estimated the impact on retail electricity prices based on the TEIS. The TEIS results were extrapolated to all IPM regions in order to estimate impacts on electricity rates using the Retail Price Model (see RIA Chapter 2.4.4.2). We modeled retail electricity rates in the no action case with unmanaged charging compared to the action case with managed charging. We think this is a reasonable approach for the reason just noted:<sup>453</sup> given the considerable

<sup>449</sup> As noted in the previous section, the 5 state peak incremental load is increased 0.6% to 3.0% (Oklahoma and Illinois respectively) when unmanaged while the same increase is only 0.4% to 1.4% (same states) when managed. The total load is consistent across unmanaged and managed as the managed simply adjusts when the load is applied. The total incremental load is increased 1.6% to 2.7% (Oklahoma and California) as a result of the action case.

<sup>450</sup> TEIS at 74.

<sup>451</sup> TEIS at 76. PEV refers to Plug-in electric vehicles. Since the TEIS is considering effects of both rules, it includes plug-in hybrid vehicles as part of its analysis.

<sup>452</sup> TEIS at 4.

<sup>453</sup> Electricity demand in the action case was based on the interim control case described in RIA Chapter 4.2.4 for heavy-duty ZEVs and on Alternative 3 from the proposed “Multipollutant Emissions Standards for Model Years 2027 and Later Light-Duty and Medium-Duty Vehicles” for light- and medium-duty vehicles. This scenario was used in our modeling of charging costs in HD

economic benefits of managed charging, particularly in light of the increased PEV adoption associated with the modeled potential compliance pathway of the final rule, there is an extremely strong economic incentive for market actors to adopt managed charging practices. Our analysis projects that there is no difference in retail electricity prices in 2030 and the difference in 2055 is only 2.5 percent.<sup>454</sup> We estimate that the 2.5 percent difference is primarily due to distribution-level costs. Note also that this is comparable to the 3 percent increase in distribution-level investments estimated for the 5 states within the TEIS.<sup>455</sup>

A -3 percent increase in distribution system build out correlates to a small increase in manufacturing output so concerns regarding supply chain timing and cost are minimal. The total costs are modest both in and of themselves, as a percentage of grid investment even without considering mitigation strategies, and in terms of effect on electricity rates for users. EPA thus believes that the costs associated with distribution grid buildout attributable to the Phase 3 rule are reasonable. See further discussion in preamble section II.E.5.ii as to how we account for these costs in our analysis, and note further that the TEIS cost estimates are reflected in that analysis. See RIA Chapter 2.4.4.2. For a discussion of how we accounted for distribution upgrade costs in our final rule analysis, see preamble section II.E.5.ii and RIA Chapter 2.4.4.2.

d. Electricity Generation and, Transmission Reliability

As vehicle electrification load increases, alongside other new loads from data centers, industry, and building electrification, the grid will need to accommodate higher loads on generation and transmission (in addition to distribution buildout, which is already discussed). Our examination of the record, informed by our consultations with DOE, FERC, and other power sector stakeholders, is that the final standards of this rule, whether considered separately or in combination with the light and medium duty vehicle standards and upcoming power sector rules, are unlikely to adversely affect the

TRUCS, as described in RIA Chapter 2.4.4.2. The no action case described here is presented for comparative purposes, but was not utilized in our HD TRUCS modeling.

<sup>454</sup> We note that had we compared an unmanaged action scenario with an unmanaged no-action scenario, or a managed action scenario with a managed no-action scenario, we would expect only marginally different electricity rates, given that distribution costs are a very small part of total electricity costs.

<sup>455</sup> TEIS at 74.

reliability of the electric grid, and that widespread adoption of HD BEVs could have significant benefits for the electric power system.

In the balance of this section, we first provide an overview of the electric power system and grid reliability. We then discuss the impacts of this rule on generation. We find that the final rule, together with the light and medium duty rule, are associated with modest increases in electricity demand. We also conducted an analysis of resource adequacy, which is an important metric in North American Electric Reliability Corporation's (NERC) long-term reliability assessments. We find that the final rule, together with the light and medium duty rule as well as other EPA rules that regulate the EGU sector, are unlikely to adversely affect resource adequacy. We then discuss transmission and find that the need for new transmission lines associated with this rule and the light and medium duty rule between now and 2050 is projected to be very small, approximately one percent or less of transmission, and that nearly all of the additional buildout overlaps with existing transmission line right of ways. We find that this increase can reasonably be managed by the utility sector and project that transmission capacity will not constrain the increased demand for electricity associated with the final rule.

Our electric power system can be broken down into three subsystems: the electricity power generation, the electricity transmission network, and the electricity distribution grid. This review covers each of these subsystems in turn, beginning with generation. Electricity generation is currently reliable, with ample resource adequacy, and the power sector analysis conducted in support of this rule indicates that resource adequacy will continue to remain unaffected. In the NPRM, we modeled changes to power generation due to the increased electricity demand anticipated in the proposal as part of our upstream analysis. In the proposal, we concluded that grid reliability is not expected to be adversely affected by the modest increase in electricity demand associated with projected HD ZEV. 88 FR 25983. Several commenters stated that EPA had failed to account for the combined impact of various EPA rules when assessing the issue of grid reliability. These rules cited by commenters (many of which were proposed rules) include not only the proposed rule concerning emission standards for LDVs and MDVs, but also the proposed rule for CO<sub>2</sub> emissions from electricity generating units, the

cross-state air pollution rule, the proposed rule for discharge to navigable waters for steam electric units (under the Clean Water Act), and the proposed rule to control leakage and other releases from of historic surface impoundments used to manage waste from coal combustion (under the Resource Conservation and Recovery Act). Other commenters agreed that the anticipated power needed for the HD Phase 3 rule is a relatively small share of the national electricity demand and that power generating capacity will not be a constraint. These comments came from the electric utility sector, from regulated entities themselves, from NGOs, and from affected states.

The electric power system in the U.S. has historically been a very reliable system,<sup>456</sup> with utilities, system planners, and reliability coordinators working together to ensure an efficient and reliable grid with adequate resources for supply to meet demand at all times, and we anticipate that this will continue in the future under these standards.

Power interruptions caused by extreme weather are the most-commonly reported, naturally-occurring factors affecting grid reliability, with the frequency of these severe weather events increasing significantly over the past twenty years due to climate change.<sup>457</sup> Conversely, decreasing emissions of greenhouse gases can be expected to help reduce future extreme weather events, which would serve to reduce the risks for electric power sector reliability. Extreme weather events include snowstorms, hurricanes, and wildfires. These power interruptions have significant impact on economic activity, with associated costs in the U.S. estimated to be \$44 billion annually.<sup>458</sup> By requiring significant reductions in GHGs from new motor vehicles, this rule mitigates the harmful impacts of climate change, including the increased incidence of extreme weather events that affect grid reliability.

The average duration of annual electric power interruptions in the U.S., approximately two hours, decreased slightly from 2013 to 2021, when extreme weather events associated with

climate change are excluded from reliability statistics. When extreme weather events associated with climate change are not excluded from reliability statistics, the national average length of annual electric power interruptions increased to about seven hours.<sup>459</sup>

Around 93 percent of all power interruptions in the U.S. occur at the distribution-level, with the remaining fraction of interruptions occurring at the transmission- and generation-levels.<sup>460</sup> As new light-duty PEV models continue to enter the U.S. market, they are demonstrating increasing capability for use as distributed grid energy resources. As of January 2024, manufacturers have introduced, or plan to introduce, 24 MYs 2024–2025 PEVs with bidirectional charging capable of supporting two to three days of residential electricity consumption. These PEVs have capability to discharge power on the order of 10 kW to residential loads or limited commercial loads. As more HD BEVs enter the market, BEVs with larger batteries and more power available will be available for bidirectional charging. Such a capability could be used to provide limited backup power to service stations providing petroleum fuels to emergency vehicles in response to a local disruption in electrical service.<sup>462</sup>

We now turn to the impacts of this rule on generation and resource adequacy. As discussed in Chapter 4 of the RIA and as part of our upstream analysis, we used MOVES to model changes to power generation due to the increased electricity demand anticipated under the final standards. Bulk generation and transmission system impacts are felt on a larger scale, and thus tend to reflect smoother load growth and be more predictable in nature. For a no action case, we project that generation will increase by 4.2 percent between 2028 and 2030 and by 36 percent between 2030 and 2050. Further, we project the additional generation needed to meet the projected demand of HD ZEVs from the final rule combined with our estimate of the light-

<sup>459</sup> EIA, U.S. electricity customers averaged seven hours of power interruptions in 2021, 2022, <https://www.eia.gov/todayinenergy/detail.php?id=54639#>.

<sup>460</sup> Eto, Joseph H., Kristina Hamachi LaCommare, Heidemarie C Caswell, and David Till. "Distribution system versus bulk power system: identifying the source of electric service interruptions in the US." IET Generation, Transmission & Distribution 13.5 (2019) 717–723.

<sup>461</sup> Larsen, P.H., LaCommare, K.H., Eto, J.H., & Sweeney, J.L. (2015). Assessing changes in the reliability of the US electric power system.

<sup>462</sup> Mulfati, Justin. dcBel, "New year, new bidirectional cars: 2024 edition" January 15, 2024. Accessed March 10, 2024. Available at: <https://www.dcbel.energy/blog/2024/01/15/new-year-new-bidirectional-cars-2024-edition/>.

<sup>456</sup> NREL, "Explained: Reliability of the Current Power Grid", NREL/FS-6A40-87297, January 2024 (<https://www.nrel.gov/docs/fy24osti/87297.pdf>).

<sup>457</sup> DOE, Electric Disturbance Events (OE-417) Annual Summaries for 2000 to 2023, [https://www.oe.netl.doe.gov/OE417\\_annual\\_summary.aspx](https://www.oe.netl.doe.gov/OE417_annual_summary.aspx).

<sup>458</sup> LaCommare, K.H., Eto, J.H., & Caswell, H.C. (2018, June). Distinguishing Among the Sources of Electric Service Interruptions. In 2018 IEEE International Conference on Probabilistic Methods Applied to Power Systems (PMAPS) (pp. 1–6). IEEE.

and medium-duty PEVs under the light and medium duty multipollutant rule, to be relatively modest compared to a no action case, ranging from 0.93 percent in 2030 to approximately 12 percent in 2050 for both actions combined. Of that increased generation, approximately 16 percent in 2030 and approximately 34 percent in 2050 is due to heavy-duty ZEVs. Electric vehicle charging associated with the Action case (light- and medium-duty combined with heavy-duty) is expected to require 4 percent of the total electricity generated in 2030, which is slightly more than the increase in total U.S. electricity end-use consumption between 2021 and 2022.<sup>463</sup> This is also roughly equal to the combined latest U.S. annual electricity consumption estimates for data centers<sup>464</sup> and cryptocurrency mining operations,<sup>465</sup> both industries which have grown significantly in recent years and whose electricity demand the utility sector has capably managed.<sup>466</sup> EPA's assessment is that national power generation will continue to be sufficient as demand increases from electric vehicles associated with both the HD Phase 3 Rule and the light and medium duty rule.

Given the additional electricity demand associated with increasing adoption of electric vehicles, some commenters raised concerns that the additional demand associated with the rule could impact the reliability of the power grid.<sup>467</sup> To further assess the impacts of this rule on grid reliability and resource adequacy, we conducted an additional grid reliability assessment of the impacts of the rule and how projected outcomes under the rule

<sup>463</sup> U.S. Energy Information Agency, Use of Electricity, December 18, 2023. <https://www.eia.gov/energyexplained/electricity/use-of-electricity.php>.

<sup>464</sup> U.S. DOE Office of Energy Efficiency and Renewable Energy, Data Centers and Servers (<https://www.energy.gov/eere/buildings/data-centers-and-servers>).

<sup>465</sup> U.S. Energy Information Agency, Tracking Electricity Consumption From U.S. Cryptocurrency Mining Operations, February 1, 2024, (<https://www.eia.gov/todayinenergy/detail.php?id=61364>).

<sup>466</sup> As we noted at proposal, and as several commenters agreed, U.S. electric power utilities routinely upgrade the nation's electric power system to improve grid reliability and to meet new electric power demands. For example, when confronted with rapid adoption of air conditioners in the 1960s and 1970s, U.S. electric power utilities maintained reliability and met the new demand for electricity by planning and building upgrades to the electric power distribution system.

<sup>467</sup> EPA notes that manufacturers have a wide array of compliance options, as discussed in section II.F.4 of the preamble. For example, manufacturers could produce significantly fewer ZEVs than in the central case, or even no ZEVs beyond the no action baseline. Were manufacturers to choose these compliance pathways, the increasing in electricity demand associated with the rule would be smaller.

compare with projected baseline outcomes in the presence of the IRA. Because we recognize that this rule is being developed contemporaneously with the multipollutant emissions standards for light-duty passenger cars and light trucks and for Class 2b and 3 vehicles, which also is anticipated to increase demand for electricity, we analyzed the impacts of these two rules (the "Vehicle Rules") on the grid together. EPA also considered several recently proposed rules related to the grid that may directly impact the EGU sector (which we refer to as "Power Sector Rules"<sup>468</sup>).

Specifically, we considered whether the Vehicles Rules alone and combined with the Power Sector Rules would result in anticipated power grid changes such that they (1) respect and remain within the confines of key National Electric Reliability Corporation (NERC) assumptions,<sup>469</sup> (2) are consistent with historical trends and empirical data, and (3) are consistent with goals, planning efforts and Integrated Resource Plans (IRPs) of industry itself.<sup>470</sup> We

<sup>468</sup> The recently proposed rules that we considered because they may impact the EGU sector (which we refer to as "Power Sector Rules") include: the proposed Existing and Proposed Supplemental Effluent Limitations Guidelines and Standards for the Steam Electric Power Generation Point Source Category (88 FR 18824) ("ELG Rule"), New Source Performance Standards for GHG Emissions from New, Modified, and Reconstructed Fossil Fuel-Fired EGUs; Emission Guidelines for GHG emissions from Existing Fossil Fuel-Fired EGUs (88 FR 33240) ("111 EGU Rule"); and National Emissions Standards for Hazardous Air Pollutants: Coal-and Oil-Fired Electric Utility Steam Generating units Review of the Residual Risk and Technology Review (88 FR 24854) ("MATS RTR Rule"); EPA also considered all final rules affecting the EGU sector in the modeling for the Vehicle Rules. EPA also considered the impact of the proposed rule Hazardous and Solid Waste Management System: Disposal of Coal Combustion Residuals From Electric Utilities (88 FR 31982 (May 18, 2023)). See RTC 7.1.

<sup>469</sup> NERC was designated by FERC as the Electric Reliability Organization (ERO) in 2005 and, therefore, is responsible for establishing and enforcing mandatory reliability standards for the North American bulk power system. Resource Adequacy Primer for State Regulators, 2021, National Association of Regulatory Utility Commissioners (<https://pubs.naruc.org/pub/752088A2-1866-DAAC-99FB-6EB5FEA73042>).

<sup>470</sup> Although this final rule was developed generally contemporaneously with the LMDV rule, the two rulemakings are separate and distinct. Since the LMDV rule was not complete as of the date of our analysis, we have been required to make certain assumptions for the purposes of this analysis to represent the results of that rule. Our analysis of the proposed Power Sector Rules is based on the modeling conducted for proposals. We believe this analysis is a reasonable way of accounting for the cumulative impacts of our rules affecting the EGU sector, including the proposed Power Sector Rules, at this time. Our cumulative analysis of the Vehicles and Power Sector Rules supports this final rule, and it does not reopen any of the Power Sector Rules, which are the subject of separate agency proceedings. Consistent with past practice, as

demonstrate that the effects of EPA's vehicle and power sector rules do not preclude the industry from meeting NERC resource adequacy criteria or otherwise adversely affect resource adequacy. This demonstration includes explicit modeling of the impacts of the Vehicle Rules, an additional quantitative analysis of the cumulative impacts of the Vehicles Rules and the Power Sector Rules, as well as a review of the existing institutions that maintain grid reliability and resource adequacy in the United States. We conclude that the Vehicles Rules, whether alone or combined with the Power Sector Rules, satisfy these criteria and are unlikely to adversely affect the power sector's ability to maintain resource adequacy or grid reliability.

Beginning with EPA's modeling of the Vehicle Rules, we used EPA's Integrated Planning Model (IPM), a model with built-in NERC resource adequacy constraints, to explicitly model the expected electric power sector impacts associated with the two vehicle rules. IPM is a state-of-the-art, peer-reviewed, multi-regional, dynamic, deterministic linear programming model of the contiguous U.S. electric power sector. It provides forecasts of least cost capacity expansion, electricity dispatch, and emissions control strategies while meeting energy demand and environmental, transmission, dispatch, and resource adequacy constraints. IPM modeling we conducted for the Vehicle Rules includes in the baseline all final rules that may directly impact the power sector, including the final Good Neighbor Plan for the 2015 Ozone National Ambient Air Quality Standards (NAAQS), 88 FR 36654.

EPA has used IPM for over two decades, including for prior successfully implemented rulemakings, to better understand power sector behavior under future business-as-usual conditions and to evaluate the economic and emissions impacts of prospective environmental policies. The model is designed to reflect electricity markets as accurately as possible. EPA uses the best available information from utilities, industry experts, gas and coal market experts, financial institutions, and government statistics as the basis for the detailed power sector modeling in IPM. The model documentation provides additional information on the assumptions discussed here as well as all other model assumptions and inputs. EPA relied on the same model platform

subsequent rules are finalized, EPA will perform additional power sector modeling that accounts for the cumulative impacts of the rule being finalized together with existing final rules at that time.

at final as it did at proposal, but made substantial updates to reflect public comments. Of particular relevance, the model framework relies on resource adequacy-related constraints that come directly from NERC. This includes NERC target reserve margins for each region, NERC Electricity Supply & Demand load factors, and the availability of each generator to serve load across a given year as reported by the NERC Generating Availability Data System. Note that unit-level availability constraints in IPM are informed by the average planned/unplanned outage hours for NERC Generating Availability Data System.

Therefore, the model projections for the Vehicle Rules are showing compliance pathways respecting these NERC resource adequacy criteria. These NERC resource adequacy criteria are standards by which FERC, NERC and the power sector industry judge that the grid is capable of meeting demand. Thus, we find that modeling results demonstrating that the grid will continue to operate within those resource adequacy criteria supports the conclusion that the rules will not have an adverse impact on resource adequacy, which is an essential element of grid reliability.

EPA also considered the cumulative impacts of the Vehicle Rules together with the Power Sector Rules, which, as noted, are several recent proposed rules regulating the EGU sector. In a given rulemaking, EPA does not generally analyze the impacts of other proposed rulemakings, because those rules are, by definition, not final and do not bind any regulated entities, and because the agency does not want to prejudge separate and ongoing rulemaking processes. However, some commenters on this rule expressed concern regarding the cumulative impacts of these rules when finalized, claiming that the agency's failure to analyze the cumulative impacts of the Vehicle Rules and its EGU-sector related rules rendered this rule arbitrary and capricious. In particular, commenters argued that renewable energy could not come online quickly enough to make up for generation lost due to fossil sources that may retire, and that this together with the increasing demand associated with the Vehicle Rules would adversely affect resource adequacy and grid reliability. EPA conducted additional analysis of these cumulative impacts in response to these comments. Our analysis finds that the cumulative impacts of the Vehicle Rules and Power Sector Rules is associated with changes to the electric grid that are well within the range of fleet conditions that respect

resource adequacy, as projected by multiple, highly respected peer-reviewed models. In other words, taking into consideration a wide range of potential impacts on the power sector as a result of the IRA and Power Sector Rules (including the potential for much higher variable renewable generation), as well the potential for increased demand for electricity from both this rule and the light and medium duty rule, EPA found that the Vehicle Rules and proposed Power Sector Rules are not expected to adversely affect resource adequacy and that EPA's rules will not inhibit the industry from its responsibility to maintain a grid capable of meeting demand without disruption.

Finally, we note the numerous existing and well-established institutional guardrails at the Federal- and state-level, as well as non-governmental organizations, which we expect to continue to maintain resource adequacy and grid reliability. These well-established institutions—including the Federal Energy Regulatory Commission (FERC), state Public Service Commissions (PSC), Public Utility Commissions (PUC), and state energy offices, as well as NERC and Regional Transmission Organization (RTO) and Independent System Operator (ISO)—have been in place for decades, during which time they have ensured the resource adequacy and reliability of the electric power sector. As such, we expect these institutions will continue to ensure that the electric power sector is safe and reliable, and that utilities will proactively plan for electric load growth associated with all future electricity demand, including those increases due to our final rule. We also expect that utilities will continue to collaborate with EGU owners to ensure that any EGU retirements will occur in an orderly and coordinated manner. We also note that EPA's proposed Power Sector rules include built-in flexibilities that accommodate a variety of compliance pathways and timing pathways, all of which helps to ensure the resource adequacy and grid reliability of the electric power system.<sup>471</sup> In sum, the power sector analysis conducted in support of this rule indicates that the Vehicle Rules, whether alone or combined with the Power Sector Rules, are unlikely to affect the power sector's ability to maintain resource adequacy and grid reliability.<sup>472</sup>

<sup>471</sup> As noted, EPA is not prejudging the outcome of any of the Power Sector Rules.

<sup>472</sup> See "Resource Adequacy Analysis Final Rule Technical Memorandum for Multi-Pollutant Emissions Standards for Model Years 2027 and

EPA has studied the issue of grid reliability carefully and consulted with staff of DOE, FERC and the Electric Power Research Institute (EPRI) in reaching conclusions regarding bulk power system reliability and related issues. EPA's assessment is that national power generation will continue to be sufficient as demand increases from HD ZEVs as well as LD PEVs to the levels projected in the potential compliance pathways that support the feasibility of both final rules' standards while considering relevant electricity generation policy. EPA's assessment is supported by the quantified estimates from the utility industry, regulated entities, NGOs, and expert commenters, all of which corroborate EPA's conclusion and provide quantified estimates of minimal demand, which are quite similar to EPA's.<sup>473</sup>

A smaller number of commenters maintained that there could be shortages of electricity transmission capacity. We disagree. See RTC section 7.1. As described in that response, with respect to new transmission, the need for new transmission lines associated with the LMDV and HDP3 rules between now and 2050 is projected to be very small, approximately one percent or less of transmission. Nearly all of the projected new transmission builds appear to overlap with pre-existing transmission line right of ways (ROW), which makes the permitting process simpler. Approximately 41-percent of the potential new transmission line builds projected by IPM have already been independently publicly proposed by developers. The approximate regional distribution of the potential new transmission line builds are:

- 24 percent in the West (excluding Southern California), which are largely Federal lands, that are more-easily permittable for new transmission builds;
- 21 percent in the desert Southwest, which are largely Federal lands, that are more-easily permittable for new transmission builds;
- 14 percent in the Midwest;
- 9 percent for each of the Northeast, Mid-Atlantic, and Southeast and Mid-Atlantic regions; and

Later Light-Duty and Medium-Duty Vehicles, and Greenhouse Gas Emissions Standards for Heavy-Duty Vehicles—Phase 3," available in the docket for this rulemaking.

<sup>473</sup> Hibbard, Paul. "Heavy Duty Vehicle Electrification Planning for and Development of Needed Power System Infrastructure". Analysis Group for EDF. June 2023. Available Online: <https://blogs.edf.org/climate411/wp-content/blogs.dir/7/files/Analysis-Group-HDV-Charging-Impacts-Report.pdf>.

• 5 percent for each for Southern California and New York State/City regions.<sup>474</sup>

Other commenters pointed to recent regulatory actions approving several large-scale regional transmission expansions, plus actions by this Administration to expedite such expansions. DOE recently announced several programs and projects aimed at helping to alleviate the interconnection queue backlog,<sup>475 476</sup> including the Grid Resilience and Innovation Partnerships (GRIP) program, with \$10.5 billion in Bipartisan Infrastructure Law funding to develop and deploy Grid Enhancing Technologies (GET).<sup>477 478 479</sup> FERC has issued various orders to address interconnection queue backlogs, improve certainty, and prevent undue discrimination for new technologies.<sup>480 481 482</sup> FERC Order 2023, for example, requires grid operators to adopt certain interconnection practices with the goal of reducing interconnection delays. These practices include a first-ready, first-served interconnection process that requires new generators to demonstrate commercial readiness to proceed, and a cluster study interconnection process that studies many new generators together.<sup>483</sup>

<sup>474</sup> See Multi-Pollutant Emission Standards for Model Years 2027 and Later Light-Duty and Medium-Duty Regulatory Impact Analysis at 5–22 (2024).

<sup>475</sup> DOE Interconnection Innovation e-Xchange (i2X), <https://www.energy.gov/eere/i2x/interconnection-innovation-e-xchange>.

<sup>476</sup> Abboud, A.W., Gentle, J.P., Bukowski, E.E., Culler, M.J., Meng, J.P., & Morash, S. (2022). A Guide to Case Studies of Grid Enhancing Technologies (No. INL/MIS-22-69711-Rev000). Idaho National Laboratory (INL), Idaho Falls, ID (United States).

<sup>477</sup> Federal Energy Regulatory Commission, Implementation of Dynamic Line Ratings, Docket No. AD22-5-000 (87 FR 10349, February 24, 2022), <https://www.federalregister.gov/documents/2022/02/24/2022-03911/implementation-of-dynamic-line-ratings>.

<sup>478</sup> DOE, Dynamic Line Rating, 2019, <https://www.energy.gov/oe/articles/dynamic-line-rating-report-congress-june-2019>.

<sup>479</sup> DOE, Advanced Transmission Technologies, 2020, <https://www.energy.gov/oe/articles/advanced-transmission-technologies-report>.

<sup>480</sup> Federal Energy Regulatory Commission, Improvements to Generator Interconnection Procedures and Agreements, Docket No. RM22-14-000; Order No. 2023 (July 28, 2023), <https://www.ferc.gov/media/e-1-order-2023-rm22-14-000>.

<sup>481</sup> <https://www.ferc.gov/news-events/staff-presentation-improvements-generator-interconnection-procedures-and>.

<sup>482</sup> FERC regulates interstate regional transmission planning and is currently finalizing a major rule to improve transmission planning. The rule would require that transmission operators do long term planning and would require transmission providers to work with states to develop a cost allocation formula, among other changes.

<sup>483</sup> See generally FERC Order 1023, 184 FERC 61,054 (July 28, 2023) (Docket No. RM22-14-000).

Energy storage projects can also be used to help to reduce transmission line congestion and are seen as alternatives to transmission line construction in some cases.<sup>484 485</sup> These projects, known as Storage As Transmission Asset (SATA),<sup>486</sup> can help to reduce transmission line congestion, have smaller footprints, have shorter development, permitting, and construction times, and can be added incrementally, as required. Examples of SATA projects include the ERCOT Presidio Project,<sup>487</sup> a 4 MW battery system that improves power quality and reducing momentary outages due to voltage fluctuations, the APS Punkin Center,<sup>488</sup> a 2 MW, 8 MWh battery system deployed in place of upgrading 20 miles of transmission and distribution lines, the National Grid Nantucket Project,<sup>489</sup> a 6 MW, 48 MWh battery system installed on Nantucket Island, MA, as a contingency to undersea electric supply cables, and the Oakland Clean Energy Initiative Projects,<sup>490</sup> a 43.25 MW, 173 MWh energy storage project to replace fossil generation in the Bay area. Through such efforts, the interconnection queues can be reduced in length, transmission capacity on existing transmission lines can be increased, additional generation assets can be brought online, and electricity generated by existing assets will be curtailed less often. These factors help to improve overall grid reliability.

The previous sections cover grid reliability in the sense of adequacy and primarily address if the electricity generation and transmission subsystems can deliver the required power to the distribution subsystem. The ability of

<sup>484</sup> Federal Energy Regulatory Commission, Managing Transmission Line Ratings, Docket No. RM20-16-000; Order No. 881 (December 16, 2021), <https://www.ferc.gov/media/e-1-rm20-16-000>.

<sup>485</sup> Federal Energy Regulatory Commission, Staff Presentation Final Order Regarding Managing Transmission Line Ratings FERC Order 881 (December 16, 2021), <https://www.ferc.gov/news-events/news/staff-presentation-final-order-regarding-managing-transmission-line-ratings>.

<sup>486</sup> Nguyen, T.A., & Byrne, R.H. (2020). Evaluation of Energy Storage As A Transmission Asset (No. SAND2020-9928C). Sandia National Lab. (SNL-NM), Albuquerque, NM (United States).

<sup>487</sup> <http://www.ettexas.com/Content/documents/NaSBatteryOverview.pdf>.

<sup>488</sup> Arizona Public Service Company, 2023 Integrated Resource Plan, [https://www.aps.com/-/media/APS/APSCOM-PDFs/About/Our-Company/Doing-business-with-us/Resource-Planning-and-Management/APS\\_IRP\\_2023\\_PUBLIC.ashx](https://www.aps.com/-/media/APS/APSCOM-PDFs/About/Our-Company/Doing-business-with-us/Resource-Planning-and-Management/APS_IRP_2023_PUBLIC.ashx).

<sup>489</sup> Balducci, P.J., et al. (2019). Nantucket island energy storage system assessment (No. PNNL-28941). Pacific Northwest National Lab. (PNNL), Richland, WA (United States), <https://energystorage.pnnl.gov/pdf/PNNL-28941.pdf>.

<sup>490</sup> <https://www.pgecurrents.com/articles/2799-pg-e-proposes-two-energy-storage-projects-oakland-clean-energy-initiative-cpuc>.

the distribution system to develop in a timely and cost effective manner and support what may be required for the HD Phase 3 and LMDV rules, is covered in section II.D.2.iii.a and iii.b of this preamble. Here, the issue of grid reliability and resilience assumes the required hardware is in place and assesses if that hardware will continue to deliver electricity with a high probability of success. Comments showed concern that the grid may not have adequate reliability due to severe storms, wildfires, and similar challenges. Commenters emphasized that without electricity supply, many HD BEV would not be able to deliver the work required.

We first note that most of these comments were general, posing potential issues of grid reliability unrelated to potential demand resulting from the HD Phase 3 standards. As noted, that demand is low and encompassable within the HD Phase 3 rule's time frame. In response to these general comments, we note that the U.S. electricity grid continues to be very reliable. Power interruptions caused by extreme weather are the most commonly reported, naturally-occurring factors affecting grid reliability,<sup>491</sup> with the frequency of these severe weather events increasing significantly over the past twenty years due to climate change.<sup>492</sup> Conversely, decreasing emissions of greenhouse gases can be expected to avoid future extreme weather events, which would serve to increase electric power sector reliability. Extreme weather events include snowstorms, hurricanes, and wildfires. These power interruptions have significant impact on economic activity, with associated costs in the U.S. estimated to be \$44 billion annually.<sup>493</sup>

The average duration of annual electric power interruptions in the U.S., approximately two hours, decreased slightly from 2013 to 2021, when extreme weather events associated with climate change are excluded from reliability statistics. When extreme weather events associated with climate change are not excluded from reliability statistics, the national average length of

<sup>491</sup> DOE, Electric Disturbance Events (OE-417) Annual Summaries 2023, [https://www.oe.netl.doe.gov/OE417\\_annual\\_summary.aspx](https://www.oe.netl.doe.gov/OE417_annual_summary.aspx).

<sup>492</sup> DOE, Electric Disturbance Events (OE-417) Annual Summaries for 2000 to 2023, [https://www.oe.netl.doe.gov/OE417\\_annual\\_summary.aspx](https://www.oe.netl.doe.gov/OE417_annual_summary.aspx).

<sup>493</sup> LaCommare, K.H., Eto, J.H., & Caswell, H.C. (2018, June). Distinguishing Among the Sources of Electric Service Interruptions. In 2018 IEEE International Conference on Probabilistic Methods Applied to Power Systems (PMAPS) (pp. 1–6). IEEE.



annual electric power interruptions increased to about seven hours.<sup>494</sup> Around 93 percent of all power interruptions in the U.S. occur at the distribution-level, with the remaining fraction of interruptions occurring at the generation- and transmission-levels.<sup>495</sup> We do not project the HD Phase 3 rule as having a significant effect on any of these trends given the low demand on the grid posed by the rule.

### 3. HD Fuel Cell Electric Vehicle Technology and Supporting Infrastructure

Fuel cell technologies that run on hydrogen have been in existence for decades, though they are just starting to enter the heavy-duty transportation market. Hydrogen FCEVs are similar to BEVs in that they have batteries and use an electric motor instead of an internal combustion engine to power the wheels. Unlike BEVs that need to be plugged in to recharge, FCEVs have fuel cell stacks that use a chemical reaction involving hydrogen to generate electricity. Fuel cells with electric motors are more efficient than ICEs that run on gasoline or diesel, requiring less energy to fuel.<sup>497</sup>

Heavy-duty FCEVs are considered in the modeled potential compliance pathway due to several considerations. They do not emit air pollution at the tailpipe—only heat and pure water.<sup>498</sup> With current and near-future technologies, energy can be stored more densely onboard a vehicle as gaseous or liquid hydrogen than it can as electrons in a battery, which enables longer ranges. HD FCEVs can package more energy onboard with less weight than batteries in today’s BEVs, which allows for their potential use in heavy-duty sectors that are difficult for BEV technologies due to payload impacts. HD FCEVs also have rapid refueling times.<sup>499</sup>

<sup>494</sup> EIA, U.S. electricity customers averaged seven hours of power interruptions in 2021, 2022, <https://www.eia.gov/todayinenergy/detail.php?id=54639#>.

<sup>495</sup> Eto, Joseph H, Kristina Hamachi LaCommare, Heidemarie C Caswell, and David Till. “Distribution system versus bulk power system: identifying the source of electric service interruptions in the US.” IET Generation, Transmission & Distribution 13.5 (2019) 717–723.

<sup>496</sup> Larsen, P.H., LaCommare, K.H., Eto, J.H., & Sweeney, J.L. (2015). Assessing changes in the reliability of the U.S. electric power system.

<sup>497</sup> U.S. Department of Energy, Alternative Fuels Data Center. “Hydrogen Basics”. Available online: [https://afdc.energy.gov/fuels/hydrogen\\_basics.html](https://afdc.energy.gov/fuels/hydrogen_basics.html).

<sup>498</sup> U.S. Department of Energy, Fuel Cell Technologies Office. “Fuel Cells”. November 2015. Available online: [https://www.energy.gov/sites/prod/files/2015/11/f27/fcto\\_fuel\\_cells\\_fact\\_sheet.pdf](https://www.energy.gov/sites/prod/files/2015/11/f27/fcto_fuel_cells_fact_sheet.pdf).

<sup>499</sup> U.S. Department of Energy, Hydrogen and Fuel Cell Technologies Office. “The #H2IQ Hour:

In the following sections, and in RIA Chapter 1.7, we discuss key technology components unique to HD FCEVs.

#### i. Fuel Cell System

A fuel cell stack is a module that may contain hundreds of fuel cell units that generate electricity, typically combined in series.<sup>500</sup> A heavy-duty FCEV may have several fuel cell stacks to meet the power needs of a comparable ICE vehicle. A fuel cell system includes the fuel cell stacks and “balance of plant” (BOP) components (e.g., pumps, sensors, compressors, humidifiers) that support fuel cell operations.

Though there are many types of fuel cell technologies, polymer electrolyte membrane (PEM) fuel cells are typically used in transportation applications because they offer high power density and therefore have low weight and volume. They can operate at relatively low temperatures, which allows them to start quickly.<sup>501</sup> PEM fuel cells are built using membrane electrode assemblies (MEA) and supportive hardware. The MEA includes the PEM electrolyte material, catalyst layers (anode and cathode), and gas diffusion layers.<sup>502</sup> Hydrogen fuel and oxygen enter the MEA and chemically react to generate electricity, which is either used to propel the vehicle or stored in a battery to meet future power needs. The process creates excess water vapor and heat.

Key BOP components include the air supply system that provides oxygen, the hydrogen supply system, and the thermal management system. With the help of compressors and sensors, these components monitor and regulate the pressure and flow of the gases supplied to the fuel cell along with relative humidity and temperature. Similar to ICEs and batteries, PEM fuel cells require thermal management systems to control the operating temperatures. It is necessary to control operating temperatures to maintain stack voltage and the efficiency and performance of the system. There are different strategies to mitigate excess heat that comes from operating a fuel cell. For example, a HD vehicle may include a cooling system

Heavy-Duty Vehicle Decarbonization”. September 21, 2023. Available online: <https://www.energy.gov/sites/default/files/2023-10/h2iqhour-09212023.pdf>.

<sup>500</sup> U.S. Department of Energy, Hydrogen and Fuel Cell Technologies Office. “Fuel Cell Systems”. Available online: <https://www.energy.gov/eere/fuelcells/fuel-cell-systems>.

<sup>501</sup> U.S. Department of Energy, Hydrogen and Fuel Cell Technologies Office. “Types of Fuel Cells”. Available online: <https://www.energy.gov/eere/fuelcells/types-fuel-cells>.

<sup>502</sup> U.S. Department of Energy, Hydrogen and Fuel Cell Technologies Office. “Parts of a Fuel Cell”. Available online: <https://www.energy.gov/eere/fuelcells/parts-fuel-cell>.

that circulates cooling fluid through the stack.<sup>503</sup> As the fuel cell ages and becomes less efficient, more waste heat will be generated that requires removal. A cooling system may be designed to accommodate end-of-life needs, which can be up to two times greater than they are at the beginning of life.<sup>504</sup> Waste heat recovery solutions are emerging.<sup>505</sup> The excess heat also can in turn be used to heat the cabin, similar to ICE vehicles. Power consumed to operate BOP components can also impact the fuel cell system’s overall efficiency.<sup>506</sup> <sup>507</sup>

To improve fuel cell performance, the air and hydrogen fuel that enter the system may be compressed, humidified, and/or filtered.<sup>508</sup> A fuel cell operates best when the air and the hydrogen are free of contaminants, since contaminants can poison and damage the catalyst. PEM fuel cells require hydrogen that is over 99 percent pure, which can add to the fuel production cost.<sup>509</sup> <sup>510</sup> Hydrogen produced from natural gas tends to have more impurities initially (e.g., carbon monoxide and ammonia, associated with the reforming of hydrocarbons) than hydrogen produced from water through electrolysis.<sup>511</sup> There are

<sup>503</sup> Hyfindr. “Fuel Cell Stack”. Available online: <https://hyfindr.com/fuel-cell-stack/>.

<sup>504</sup> Pardhi, Shantanu, et. al. “A Review of Fuel Cell Powertrains for Long-Haul Heavy-Duty Vehicles: Technology, Hydrogen, Energy and Thermal Management Systems”. *Energies* 15(24). December 2022. Available online: <https://www.mdpi.com/1996-1073/15/24/9557>.

<sup>505</sup> Baroutaji, Ahmad, et. al. “Advancements and prospects of thermal management and waste heat recovery of PEMFC”. *International Journal of Thermofluids: Volume 9*. February 2021. Available online: <https://www.sciencedirect.com/science/article/pii/S2666202721000021>.

<sup>506</sup> Hoefflinger, Johannes and Peter Hofmann. “Air mass flow and pressure optimization of a PEM fuel cell range extender system”. *International Journal of Hydrogen Energy*. Volume 45:53. October 30, 2020. Available online: <https://www.sciencedirect.com/science/article/pii/S0360319920327841>.

<sup>507</sup> Pardhi, Shantanu, et. al. “A Review of Fuel Cell Powertrains for Long-Haul Heavy-Duty Vehicles: Technology, Hydrogen, Energy and Thermal Management Systems”. *Energies* 15(24). December 2022. Available online: <https://www.mdpi.com/1996-1073/15/24/9557>.

<sup>508</sup> U.S. Environmental Protection Agency. “Assessment of Fuel Cell Technologies at Ports”. Prepared for EPA by Eastern Research Group, Inc. EPA-420-R-22-013. July 2022. Available online: <https://nepis.epa.gov/Exe/ZyPDF.cgi?Dockey=P1015AQX.pdf>.

<sup>509</sup> Hyfindr. “Hydrogen PEM Fuel Cell”. Available online: <https://hyfindr.com/pem-fuel-cell/>.

<sup>510</sup> U.S. DRIVE Partnership. “Hydrogen Production Tech Team Roadmap”. U.S. Department of Energy. November 2017. Available online: <https://www.energy.gov/eere/vehicles/articles/us-drive-hydrogen-production-technical-team-roadmap>.

<sup>511</sup> Nhuyen, Huu Linh, et. al. “Review of the Durability of Polymer Electrolyte Membrane Fuel

Continued

standards such as ISO 14687 that include hydrogen fuel quality specifications for use in vehicles to minimize impurities.<sup>512</sup>

Fuel cell durability is important in heavy-duty applications, given that vehicle owners and operators often have high expectations for drivetrain lifetimes in terms of years, hours, and miles. Fuel cells can be designed to meet durability needs (*i.e.*, the ability of the stack to maintain its performance over time). Considerations must be included in the design to accommodate operations in less-than-optimized conditions. For example, prolonged operation at high voltage (low power) or when there are multiple transitions between high and low voltage can stress the system. As a fuel cell system ages, a fuel cell's MEA materials can degrade, and performance and maximum power output can decline. The fuel cell can become less efficient, which can cause it to generate more excess heat and consume more fuel.<sup>513</sup> DOE's ultimate long-term technology target for Class 8 HD trucks is a fuel cell lifetime of 30,000 hours, corresponding to an expected vehicle lifetime of 1.2 million miles.<sup>514</sup> A voltage degradation of 10 percent at rated power (*i.e.*, the power level the cell is designed for) by end-of-life is considered by DOE when evaluating targets.<sup>515</sup>

Currently, the fuel cell stack is the most expensive component of a fuel cell system,<sup>516</sup> which is the most expensive part of a heavy-duty FCEV, primarily due to the technological requirements of manufacturing rather than raw material

costs.<sup>517</sup> Larger production volumes are anticipated as global demand increases for fuel cell systems for HD vehicles, which could improve economies of scale.<sup>518</sup> Durability improvements are anticipated to also result in decreased operating costs, as they could extend the life of fuel cells and reduce the need for parts replacement.<sup>519</sup> Fuel cells contain PEM catalysts that typically are made using precious metals from the platinum group, which are expensive but efficient and can withstand conditions in a cell.

The U.S. Geological Survey's 2022 list of critical minerals includes platinum (as one of several platinum group metals, or PGMs), as used in catalytic converters. Critical minerals are defined in the Energy Act of 2020 as being essential to the economic or national security of the U.S. and vulnerable to supply chain disruption.<sup>520</sup> DOE's 2023 Critical Materials Assessment, performed independently from a global perspective and focused on the importance of materials to clean energy technologies in future years, identifies PGMs used in hydrogen electrolyzers such as platinum and iridium as critical. They screened out PGMs used in catalytic converters, such as rhodium and palladium. This distinction was made due to the increased focus on hydrogen technologies, including long-distance HD trucks, to achieve carbon emissions reductions, and an anticipated decrease in the importance of catalytic converters in the medium term (*i.e.*, the 2025 to 2035 timeframe).<sup>521</sup>

Efforts are underway to minimize or eliminate the use of platinum in catalysts.<sup>522</sup> DOE issued a Funding

Opportunity Announcement (FOA) in 2023 in anticipation of growth in hydrogen and fuel cell technologies and systems. A portion of the FOA is designed to enable improvements in recovery and recycling, and applicants are encouraged to find ways to reduce or eliminate PGMs from catalysts in both PEM fuel cells and electrolyzers to reduce reliance on virgin feedstocks.<sup>523</sup>

ii. Fuel Cell and Battery Interaction

The instantaneous power required to move a FCEV can come from either the fuel cell, the battery, or a combination of both. Interactions between the fuel cells and batteries of a FCEV can be complex and may vary based on application. Each manufacturer likely will employ a unique strategy to optimize the durability of these components and manage costs. The strategy selected will impact the size of the fuel cell and the size of the battery.

The fuel cell can be used to charge the battery that in turn powers the wheels (*i.e.*, series hybrid or range-extending), or it can work with the battery to provide power (*i.e.*, parallel hybrid or primary power) to the wheels. In the emerging HD FCEV market, when used to extend range, the fuel cell tends to have a lower peak power potential and may be sized to match the average power needed during a typical use cycle, including steady highway driving. At idle, the fuel cell may run at minimal power or turn off based on state of charge of the battery. The battery is used during prolonged high-power operations such as grade climbing and is typically in charge-sustaining mode, which means the average state of charge is maintained above a certain level while driving. When providing primary power, the fuel cell tends to have a larger peak power potential, sized to match all power needs of a typical duty cycle and to meet instantaneous power needs. The battery is mainly used to capture energy from regenerative braking and to help with acceleration and other transient power demands.<sup>524</sup>

Cell in Long-Term Operation: Main Influencing Parameters and Testing Protocols". *Energies* 14(13). July 2021. Available online: <https://www.mdpi.com/1996-1073/14/13/4048>.

<sup>512</sup> International Organization for Standardization. "ISO 14687: 2019, Hydrogen fuel quality—Product specification". November 2019. Available online: <https://www.iso.org/standard/69539.html>.

<sup>513</sup> Nguyen, Huu Linh, et al. "Review of the Durability of Polymer Electrolyte Membrane Fuel Cell in Long-Term Operation: Main Influencing Parameters and Testing Protocols". *Energies* 14(13). July 2021. Available online: <https://www.mdpi.com/1996-1073/14/13/4048>.

<sup>514</sup> Marcinkoski, Jason et al. "Hydrogen Class 8 Long Haul Truck Targets". U.S. Department of Energy. October 31, 2019. Available online: [https://www.hydrogen.energy.gov/pdfs/19006\\_hydrogen\\_class8\\_long\\_haul\\_truck\\_targets.pdf](https://www.hydrogen.energy.gov/pdfs/19006_hydrogen_class8_long_haul_truck_targets.pdf).

<sup>515</sup> Marcinkoski, Jason et al. "Hydrogen Class 8 Long Haul Truck Targets". U.S. Department of Energy. October 31, 2019. Available online: [https://www.hydrogen.energy.gov/pdfs/19006\\_hydrogen\\_class8\\_long\\_haul\\_truck\\_targets.pdf](https://www.hydrogen.energy.gov/pdfs/19006_hydrogen_class8_long_haul_truck_targets.pdf).

<sup>516</sup> Papageorgopoulos, Dimitrios. "Fuel Cell Technologies Overview". U.S. Department of Energy. June 6, 2023. Available online: [https://www.hydrogen.energy.gov/docs/hydrogenprogramlibraries/pdfs/review23/fc000\\_papageorgopoulos\\_2023\\_o.pdf](https://www.hydrogen.energy.gov/docs/hydrogenprogramlibraries/pdfs/review23/fc000_papageorgopoulos_2023_o.pdf).

<sup>517</sup> Deloitte China and Ballard. "Fueling the Future of Mobility: Hydrogen and fuel cell solutions for transportation, Volume 1". 2020. Available online: <https://www2.deloitte.com/content/dam/Deloitte/cn/Documents/finance/deloitte-cn-fueling-the-future-of-mobility-en-200101.pdf>.

<sup>518</sup> Deloitte China and Ballard. "Fueling the Future of Mobility: Hydrogen and fuel cell solutions for transportation, Volume 1". 2020. Available online: <https://www2.deloitte.com/content/dam/Deloitte/cn/Documents/finance/deloitte-cn-fueling-the-future-of-mobility-en-200101.pdf>.

<sup>519</sup> Deloitte China and Ballard. "Fueling the Future of Mobility: Hydrogen and fuel cell solutions for transportation, Volume 1". 2020. Available online: <https://www2.deloitte.com/content/dam/Deloitte/cn/Documents/finance/deloitte-cn-fueling-the-future-of-mobility-en-200101.pdf>.

<sup>520</sup> 87 FR 10381. "2022 Final List of Critical Minerals". U.S. Geological Survey. February 24, 2022. Available online: <https://www.federalregister.gov/documents/2022/02/24/2022-04027/2022-final-list-of-critical-minerals>.

<sup>521</sup> U.S. Department of Energy. "Critical Materials Assessment". July 2023. Available online: [https://www.energy.gov/sites/default/files/2023-07/doe-critical-material-assessment\\_07312023.pdf](https://www.energy.gov/sites/default/files/2023-07/doe-critical-material-assessment_07312023.pdf).

<sup>522</sup> Berkeley Lab. "Strategies for Reducing Platinum Waste in Fuel Cells. November 2021. Available online: <https://als.lbl.gov/strategies-for-reducing-platinum-waste-in-fuel-cells/>.

<sup>523</sup> U.S. Department of Energy, Hydrogen and Fuel Cell Technologies Office. "Bipartisan Infrastructure Law: Clean Hydrogen Electrolysis, Manufacturing, and Recycling: Funding Opportunity Announcement Number DE-FOA-0002922". March 15, 2023 (Last Updated: March 31, 2023). Available online: <https://eere-exchange.energy.gov/Default.aspx?FoalIda9a89bda-618a-4f13-83f4-9b9b418c04dc>.

<sup>524</sup> Islam, Ehsan Sabri, Ram Vijayagopal, Aymeric Rousseau. "A Comprehensive Simulation Study to Evaluate Future Vehicle Energy and Cost Reduction Potential". Report to the U.S. Department of Energy, Contract ANL/ESD-22/6. October 2022. See Full report. Available online: <https://anl.app.box.com/s/an4nx0v2xpudxtpsnkhdspeimzu4j1hk/file/1406494585829>.

Based on how the fuel cells and batteries are managed, manufacturers may use different types of batteries in HD FCEVs. Energy battery cells are typically used to store energy for applications with distance needs. Power battery cells are typically used to provide additional high power for applications with high power needs.<sup>525</sup>

### iii. Onboard Hydrogen Storage Tanks

Fuel cell vehicles carry hydrogen fuel onboard using multiple large tanks. Hydrogen has high gravimetric density (amount of energy stored per unit of mass) but extremely low volumetric density (amount of energy stored per volume), so it must be compressed or liquified for use. There are various techniques for storing hydrogen onboard a vehicle, depending on how much fuel is needed to meet range requirements. Most transportation applications today use Type IV tanks,<sup>526</sup> which typically include a plastic liner wrapped with a composite material such as carbon fiber that can withstand high pressures with minimal weight.<sup>527</sup> High-strength carbon fiber accounts for over 50 percent of the cost of a Type IV onboard storage system at production volumes of over 100,000 systems per year.<sup>529</sup>

Some existing fuel cell buses use compressed hydrogen gas at 350 bar (~5,000 pounds per square inch, or psi) of pressure, but other applications are using tanks with increased compressed hydrogen gas pressure at 700 bar (~10,000 psi) for extended driving range.<sup>530</sup> A Heavy-Duty Vehicle Industry Group was formed in 2019 to standardize 700 bar high-flow fueling

hardware components globally that meet fueling speed requirements (*i.e.*, so that fill times are similar to comparable HD ICE vehicles, as identified in DOE technical targets for Class 8 long-haul tractor-trailers).<sup>531</sup> High-flow refueling rates for heavy-duty vehicles of 60 to 80 kg hydrogen in under 10 minutes were recently demonstrated in a DOE lab setting.<sup>532</sup> <sup>533</sup> <sup>534</sup>

As we stated in the NPRM, geometry and packaging challenges may constrain the amount of gaseous hydrogen that can be stored onboard and, thus, the maximum range of trucks that travel longer distances without a stop for fuel.<sup>535</sup> Liquid hydrogen is emerging as a cost-effective onboard storage option for long-haul operations; however, the technology readiness of liquid storage and refueling technologies is relatively low compared to compressed gas technologies.<sup>536</sup> <sup>537</sup> Therefore, given our assessment of technology readiness, liquid storage tanks were not included in the potential compliance pathway that supports the feasibility and appropriateness of our standards.

In the NPRM, we requested comment and data related to packaging space

<sup>531</sup> NextEnergy. "Hydrogen Heavy Duty Vehicle Industry Group to Standardize Hydrogen Refueling, Bringing Hydrogen Closer to Wide Scale Adoption". October 8, 2021. Available online: <https://nextenergy.org/hydrogen-heavy-duty-vehicle-industry-group-partners-to-standardize-hydrogen-refueling/>.

<sup>532</sup> DOE suggests that 60 kg of H<sub>2</sub> will be required to achieve a 750-mile range in a Class 8 tractor-trailer truck, assuming a fuel economy of 12.4 miles per kilogram. In the DOE lab, one fill (61.5 kg) was demonstrated from the fueling station into seven type-IV tanks of a HD vehicle simulator, and the second fill (75.9 kg) was demonstrated from the station into nine tanks.

<sup>533</sup> Marcinkoski, Jason et. al. "Hydrogen Class 8 Long Haul Truck Targets". U.S. Department of Energy. October 31, 2019. Available online: [https://www.hydrogen.energy.gov/pdfs/19006\\_hydrogen\\_class8\\_long\\_haul\\_truck\\_targets.pdf](https://www.hydrogen.energy.gov/pdfs/19006_hydrogen_class8_long_haul_truck_targets.pdf).

<sup>534</sup> Martineau, Rebecca. "Fast Flow Future for Heavy-Duty Hydrogen Trucks: Expanded Capabilities at NREL Demonstration High-Flow-Rate Hydrogen Fueling for Heavy-Duty Applications". National Renewable Energy Lab. June 2022. Available online: <https://www.nrel.gov/news/program/2022/fast-flow-future-heavy-duty-hydrogen-trucks.html>.

<sup>535</sup> Basma, Hussein and Felipe Rodriquez. "Fuel cell electric tractor-trailers: Technology overview and fuel economy". Working Paper 2022–23. The International Council on Clean Transportation. July 2022. Available online: <https://theicct.org/wp-content/uploads/2022/07/fuel-cell-tractor-trailer-tech-fuel-jul22.pdf>.

<sup>536</sup> Basma, Hussein and Felipe Rodriquez. "Fuel cell electric tractor-trailers: Technology overview and fuel economy". Working Paper 2022–23. International Council on Clean Transportation. July 2022. Available online: <https://theicct.org/wp-content/uploads/2022/07/fuel-cell-tractor-trailer-tech-fuel-jul22.pdf>.

<sup>537</sup> Gomez, Julian A. and Diogo M.F. Santos. "The Status of On-Board Hydrogen Storage in Fuel Cell Electric Vehicles". *Designs* 2023: 7(4). Available online: <https://www.mdpi.com/2411-9660/7/4/97>.

availability associated with FCEVs and projections for the development and application of liquid hydrogen in the HD transportation sector over the next decade. 88 FR 25972. Only one comment was received on this issue, from a vehicle manufacturer, who stated that they believe liquid hydrogen is required to meet the packaging requirement for vehicles with a 500-mile range, consistent with our assessment at the proposal. The same commenter also included 90th percentile daily VMT estimates of 484 miles for Class 8 day cabs and 724 miles for sleeper cab tractors, based on an 18-day snapshot of telematics data, because they said they believe EPA is overestimating ZEV application suitability.

For the final rule, we contracted FEV Group to independently conduct a packaging analysis for Class 8 long-haul FCEVs that store 700-bar gaseous hydrogen onboard to see if space would be sufficient to accommodate hydrogen fuel for longer-range travel.<sup>538</sup> EPA conducted an external peer review of the final FEV report. FEV found ways to package six hydrogen tanks to deliver up to a 500-mile range with a sleeper cab using a 265-inch wheelbase. All tanks could be at the back of the cab in a zig-zag arrangement and the batteries mounted inside of the frame rails, or four of the tanks could be behind the cab with two tanks mounted to the outside of the frame rails under the cab and the batteries inside of the frame rails. This would allow a long-haul tractor to meet a daily operational VMT requirement of 420 miles. If a HD FCEV refuels once en route, then it could cover a 90th percentile VMT requirement of as far as 724 miles in a day (essentially matching the 90th percentile VMT noted by the commenter). A refueling event during the day should not be an unreasonable burden, given that refueling times are as short as 20 minutes or less (comparable to a diesel) and so are considered a key benefit of HD FCEVs.<sup>539</sup> See RTC section 5.3 for additional discussion.

Based on our review of the literature for the NPRM and after consideration of the comments received and additional information, our assessment is that most HD vehicles have sufficient physical

<sup>538</sup> FEV Consulting. "Heavy Duty Commercial Vehicles Class 4 to 8: Technology and Cost Evaluation for Electrified Powertrains—Final Report". Prepared for EPA. March 2024.

<sup>539</sup> U.S. Department of Energy, Hydrogen and Fuel Cell Technologies Office. "The #H2IQ Hour. Today's Topic: Heavy-Duty Vehicle Decarbonization". September 21, 2023. Available online: <https://www.energy.gov/sites/default/files/2023-10/h2iqhour-09212023.pdf>.

space to package gaseous hydrogen storage tanks onboard.<sup>540</sup> This remains the case for long-haul sleeper cabs if they refuel en route.

iv. HD FCEV Safety Assessment

FCEVs have two potential risk factors that can be mitigated through proper design, process, and training: hydrogen and electricity. Electricity risks are identical to those of BEVs and, thus, are discussed in section II.D.2 and RIA Chapter 1.5.2. Hydrogen risks can occur throughout the process of fueling a vehicle. FCEVs must be designed so that hydrogen can be safely delivered to a vehicle and then transferred into a vehicle's onboard storage tanks and fuel cell stacks. Hydrogen has been handled, used, stored, and moved in industrial settings for more than 50 years, and there are many established methods for doing so safely.<sup>541</sup> There is also Federal oversight and regulation throughout the hydrogen supply chain system.<sup>542</sup> Safety training and education are key for maintaining reasonable risk while handling and using hydrogen. For example, hydrogen-related fuel cell vehicle risks can be mitigated by following various SAE and OSHA standards, as discussed in RIA Chapter 1.7.4.

We requested comment on our assessment that HD FCEVs can be designed to maintain safety. Two comments were received that questioned the safety of FCEV. One vehicle manufacturer commenter agreed that FCEVs will be designed to maintain safety. EPA's assessment at proposal was that HD FCEV systems must be, and are, designed to always maintain safe operation. EPA reiterates that conclusion here. As EPA explained at proposal, and as noted by the vehicle manufacturer commenter, there are industry codes and standards for the safe design and operation of HD FCEVs. The Hydrogen Industry Panel on Codes, International Code Council, and National Fire Protection Association work together to develop stringent standards for hydrogen systems and fuel cells. The FCEV codes and standards

<sup>540</sup> Kast, James et. al. "Designing hydrogen fuel cell electric trucks in a diverse medium and heavy duty market". *Research in Transportation Economics: Volume 70*. October 2018. Available online: <https://www.sciencedirect.com/science/article/pii/S0739885916301639>.

<sup>541</sup> Hydrogen Tools. "Best Practices Overview". Pacific Northwest National Laboratory. Accessed on February 2, 2023. Available online: <https://h2tools.org/bestpractices/best-practices-overview>.

<sup>542</sup> Baird, Austin R. et. al. "Federal Oversight of Hydrogen Systems". Sandia National Laboratories. SAND2021-2955. March 2021. Available online: [https://energy.sandia.gov/wp-content/uploads/2021/03/H2-Regulatory-Map-Report\\_SAND2021-2955.pdf](https://energy.sandia.gov/wp-content/uploads/2021/03/H2-Regulatory-Map-Report_SAND2021-2955.pdf).

extend to service as well as emergency response. In addition, HD FCEVs are subject to, and necessarily comply with, the same Federal safety standards and the same safety testing as ICE heavy-duty vehicles. Commenters challenging the safety of HD FCEVs failed to address the existence of these protocols and Federal standards. EPA considers the multiple binding Federal safety standards and industry protocols to be effective and supports the conclusion that HD FCEV can be utilized safely. While considering safety for the NPRM, EPA coordinated with NHTSA. EPA additionally coordinated with NHTSA on safety regarding comments and updates for the final rulemaking.<sup>543</sup>

Most if not all fuels, due to their nature of transporting energy, can do harm or be unsafe if not handled properly. Although hydrogen incidents (not with FCEVs) were provided in the comments, it is important to note that there has not been a FCEV accident due to leaking hydrogen. When compared to other fuels, hydrogen is nontoxic and lighter than air, so it quickly disperses upwards unlike gas vapors that stay at ground level and has a lower radiant heat so surrounding material is less likely to ignite. One commenter questioned FCEV safety in tunnels based on a modeling study. DOE is working with other authorities to evaluate safety in tunnels as discussed in RIA chapter 1.7.4. Additionally, FCEVs including their storage systems, like ICE vehicles, are required to meet the Federal Motor Vehicle Safety Standards (FMVSS) for crash safety so that the systems will maintain their integrity after the specified crash conditions. Additional FCEV safety information is available in RIA Chapter 1.7.4 and RTC section 4.9.

v. Assessment of Heavy-Duty Hydrogen Refueling Infrastructure

As FCEV adoption grows, more hydrogen refueling infrastructure will be needed to support the HD FCEV fleet. Infrastructure is required during the production, distribution, storage, and dispensing of hydrogen fuel.

Currently, DOE's Alternative Fuels Data Center (AFDC) lists 65 public retail hydrogen fueling stations in the United States, primarily for light-duty vehicles in California.<sup>544</sup> When including

<sup>543</sup> Landgraf, Michael. Memorandum to Docket EPA-HQ-OAR-2022-0985. Summary of NHTSA Safety Communication. February 2024.

<sup>544</sup> U.S. Department of Energy, Alternative Fuels Data Center. "Hydrogen Fueling Station Locations". See Advanced Filters, Fuel, "Hydrogen" checked (not "include non-retail stations"). Accessed February 15, 2024. Available online: [https://afdc.energy.gov/fuels/hydrogen\\_locations.html#/analyze?fuel=HY](https://afdc.energy.gov/fuels/hydrogen_locations.html#/analyze?fuel=HY).

private, planned, and temporarily unavailable stations in a search, there are 99 refueling station locations nationwide.<sup>545 546 547</sup> There are also several nationally designated corridor-ready or corridor-pending Alternative Fueling Corridors for hydrogen.<sup>548</sup> Corridor-ready designations have a sufficient number of fueling stations to allow for corridor travel. The designation requires that public hydrogen stations be no greater than 150 miles apart and no greater than five miles off the highway.<sup>549</sup> Corridor-pending designations may have public stations separated by more than 150 miles, but stations cannot be greater than five miles off the highway.<sup>550</sup> The purpose of the Alternative Fuel Corridors program is to support the needed changes in the transportation sector that assists in reducing greenhouse gas emissions and improves the mobility of vehicles that employ alternative fuel technologies across the U.S.<sup>551</sup>

Though few hydrogen refueling stations exist for HD FCEVs today, EPA has seen progress on the implementation of BIL and IRA funding and other provisions to incentivize the establishment of clean hydrogen supply chain infrastructure. In June 2021, DOE

<sup>545</sup> U.S. Department of Energy, Alternative Fuels Data Center. See Advanced Filters, Station, all "Access" and "Status" options checked. Accessed February 15, 2024. Available online: [https://afdc.energy.gov/fuels/hydrogen\\_locations.html#/analyze?fuel=HY](https://afdc.energy.gov/fuels/hydrogen_locations.html#/analyze?fuel=HY).

<sup>546</sup> When including non-retail stations, there are 132. Non-retail stations involve special permissions from the original equipment manufacturers to fuel along with pre-authorization from the station provider.

<sup>547</sup> U.S. Department of Transportation, Hydrogen and Fuel Cell Technologies Office. "Fact of the Month #18-01, January 29". 2018. Available online: <https://www.energy.gov/eere/fuelcells/fact-month-18-01-january-29-there-are-39-publicly-available-hydrogen-fueling>.

<sup>548</sup> U.S. Department of Transportation, Federal Highway Administration. HEPGIS. "Hydrogen (AFC Rounds 1-7)". Accessed January 2024. Available online: <https://hepgis-usdot.hub.arcgis.com/apps/e1552ac704284d30ba8e504e3649699a/explore>.

<sup>549</sup> U.S. Department of Transportation, Federal Highway Administration. "Memorandum, INFORMATION: Request for Nominations—Alternative Fuel Corridor (Round 7/2023)". May 18, 2023. Available online: [https://www.fhwa.dot.gov/environment/alternative\\_fuel\\_corridors/nominations/2023\\_request\\_for\\_nominations\\_r7.pdf](https://www.fhwa.dot.gov/environment/alternative_fuel_corridors/nominations/2023_request_for_nominations_r7.pdf).

<sup>550</sup> U.S. Department of Transportation, Federal Highway Administration. "Alternative Fuel Corridors: Frequently Asked Questions FAST Act Section 1413—Alternative Fuel Corridor Designations Updated December 2020 to Support Round 5". Available online: [https://www.fhwa.dot.gov/environment/alternative\\_fuel\\_corridors/resources/faq/](https://www.fhwa.dot.gov/environment/alternative_fuel_corridors/resources/faq/).

<sup>551</sup> U.S. Department of Transportation, Federal Highway Administration. "Alternative Fuel Corridors". Available online: [https://www.fhwa.dot.gov/environment/alternative\\_fuel\\_corridors/](https://www.fhwa.dot.gov/environment/alternative_fuel_corridors/).

launched a Hydrogen Shot goal to reduce the cost of clean hydrogen production by 80 percent to \$1 per kilogram in one decade.<sup>552</sup> In March 2023, DOE released a Pathways to Commercial Liftoff Report on “Clean Hydrogen” to catalyze more rapid and coordinated action across the full technology value chain. Since the NPRM, the Federal Government has continued to implement BIL and IRA commitments. In June 2023, the U.S. National Clean Hydrogen Strategy and Roadmap was finalized, informed by extensive industry and stakeholder feedback, setting forth an all-of-government approach for achieving large-scale production and use of hydrogen. It includes an assessment of the opportunity for hydrogen to contribute to national decarbonization goals across sectors over the next 30 years.<sup>553</sup> Also in June 2023, DOE updated Clean Hydrogen Production Standard (CHPS) guidance that establishes a target for lifecycle (defined as “well-to-gate”) GHG emissions associated with hydrogen production, accounting for multiple requirements within the BIL provisions.<sup>554</sup> In October 2023, DOE announced the selection of seven Regional Clean Hydrogen Hubs (H2Hubs) in different regions of the country that will receive a total of \$7 billion to kickstart a national network of hydrogen producers, consumers, and connective infrastructure while supporting the production, storage, delivery, and end-use of hydrogen. The investment will be matched by recipients to leverage a total of nearly \$50 billion for the hubs, which are expected to reduce 25 million metric tons of carbon dioxide emissions each year from end uses ranging from industrial steel to HD transportation.<sup>555</sup>

<sup>552</sup> Satyapal, Sunita. “2022 AMR Plenary Session”. U.S. Department of Energy, Hydrogen and Fuel Cell Technologies Office. June 6, 2022. Available online: <https://www.energy.gov/sites/default/files/2022-06/hfto-amr-plenary-satyapal-2022-1.pdf>.

<sup>553</sup> U.S. Department of Energy. “U.S. National Clean Hydrogen Strategy and Roadmap”. June 2023. Available online: <https://www.hydrogen.energy.gov/library/roadmaps-vision/clean-hydrogen-strategy-roadmap>, <https://www.hydrogen.energy.gov/docs/hydrogenprogramlibraries/pdfs/us-national-clean-hydrogen-strategy-roadmap.pdf>.

<sup>554</sup> U.S. Department of Energy, Hydrogen Program. “Clean Hydrogen Production Standard Guidance”. June 2023. Available online: <https://www.hydrogen.energy.gov/library/policies-acts/clean-hydrogen-production-standard>, <https://www.hydrogen.energy.gov/docs/hydrogenprogramlibraries/pdfs/clean-hydrogen-production-standard-guidance.pdf>.

<sup>555</sup> U.S. Department of Energy. “Biden-Harris Administration Announces \$7 Billion For America’s First Clean Hydrogen Hubs, Driving Clean Manufacturing and Delivering New Economic Opportunities Nationwide”. October 13, 2023.

Several programs initiated by BIL and IRA are under ongoing development. In March 2023, DOE announced \$750 million for research, development, and demonstration efforts to reduce the cost of clean hydrogen. This is the first phase of \$1.5 billion in BIL funding dedicated to advancing electrolysis technologies and improving manufacturing and recycling capabilities. In July 2023, DOE released a Notice of Intent to invest up to \$1 billion in a demand-side initiative (to offer “demand pull”) to support the H2Hubs.<sup>556</sup> In January 2024, they selected a consortium to design and implement the program.<sup>557</sup> In December 2023, the Treasury Department and Internal Revenue Service proposed regulations to offer income tax credit of up to \$3 per kg for the production of qualified clean hydrogen at a qualified clean hydrogen facility (often referred to as the production tax credit, PTC, or 45V), as established in the IRA.<sup>558</sup> Final program designs are expected after this rule is finalized. See section 8.1 of the RTC and Chapter 1.8 of the RIA for additional detail.

We received several comments on the topic of hydrogen infrastructure. Some commenters were optimistic and provided support for their view. One commenter acknowledged that producing HD FCEV trucks would incentivize the building of fueling stations. Another noted that DOE programs such as the 21st Century Truck Partnership are engaged in fuel cell and hydrogen work to reduce emissions from HD trucks.<sup>559</sup> At least

Available online: <https://www.energy.gov/articles/biden-harris-administration-announces-7-billion-americas-first-clean-hydrogen-hubs-driving>.

<sup>556</sup> U.S. Department of Energy. “Biden-Harris Administration to Jumpstart Clean Hydrogen Economy with New Initiative to Provide Market Certainty and Unlock Private Investment”. July 5, 2023. Available online: <https://www.energy.gov/articles/biden-harris-administration-jumpstart-clean-hydrogen-economy-new-initiative-provide-market>.

<sup>557</sup> U.S. Department of Energy, Office of Clean Energy Demonstrations. “DOE Selects Consortium to Bridge Early Demand for Clean Hydrogen, Providing Market Certainty and Unlocking Private Sector Investment”. January 14, 2024. Available online: <https://www.energy.gov/oced/articles/doe-selects-consortium-bridge-early-demand-clean-hydrogen-providing-market-certainty>.

<sup>558</sup> 88 FR 89220. Section 45V Credit for Production of Clean Hydrogen; Section 48(a)(15) Election To Treat Clean Hydrogen Production Facilities as Energy Property. December 26, 2023. Available online: <https://www.federalregister.gov/documents/2023/12/26/2023-28359/section-45v-credit-for-production-of-clean-hydrogen-section-48a15-election-to-treat-clean-hydrogen>.

<sup>559</sup> U.S. Department of Energy. “U.S. National Clean Hydrogen Strategy and Roadmap”. June 2023. Available online: <https://www.hydrogen.energy.gov/library/roadmaps-vision/clean-hydrogen-strategy-roadmap>, <https://www.hydrogen.energy.gov/docs/hydrogenprogramlibraries/pdfs/us-national-clean-hydrogen-strategy-roadmap.pdf>.

two commenters recognized that Federal investment is expected to heavily influence the market. One commenter highlighted BIL and IRA incentives in addition to those referenced that will hasten buildout of HD FCEV refueling infrastructure, including \$2.3 billion for a Port Infrastructure Development Program over five years (2022 to 2026).<sup>560</sup> The IRA also provided EPA with \$3 billion to fund zero-emission port equipment and infrastructure and \$1 billion to fund clean heavy-duty vehicles and supportive infrastructure, including hydrogen refueling infrastructure.<sup>561</sup> One commenter said they expect to see synergies between H2Hubs and FCEVs that can launch the market even before 2030. Others suggested that infrastructure may be more of a near-term challenge, or that uncertainty could diminish over time as ZEV technologies become increasingly affordable and ubiquitous.

At least two commenters agreed there is sufficient lead time. California, a state experienced in hydrogen refueling infrastructure, shared that LD stations take around two years to build on average. They expect similar construction times for HD stations, given that a hydrogen station for HD vehicles near the Port of Oakland is expected to move from approval to commissioning in just over two years, despite permitting challenges. They cited numerous entities developing mobile refueling solutions that could provide a fueling option “bridge” during the construction of permanent stations.

Other commenters were more cautious about the readiness and availability of hydrogen infrastructure. Several indicated there are few existing hydrogen refueling stations for HD FCEVs—mostly in California—and stated that it is overly optimistic and a massive undertaking to expect buildout of a national network by 2030. One commenter noted that hydrogen fueling infrastructure is still nascent compared to BEV charging infrastructure, and several identified challenges that still need to be addressed. Challenges raised by the commenter ranged from upstream emissions and energy required to produce hydrogen, to the cost-effectiveness of distributing and

<sup>560</sup> U.S. Department of Transportation, Maritime Administration. “Port Infrastructure Development Program”. Available online: <https://www.maritime.dot.gov/PIDPgrants>.

<sup>561</sup> U.S. Environmental Protection Agency. “Clean Ports Program”. Available online: <https://www.epa.gov/ports-initiative/cleanports>.

<sup>562</sup> U.S. Environmental Protection Agency. “Clean Heavy-Duty Program”. Available online: <https://www.epa.gov/inflation-reduction-act/clean-heavy-duty-vehicle-program>.

delivering hydrogen (e.g., using gaseous or liquid technologies), to the inherent uncertainties associated with projecting emerging station needs in step with HD FCEV adoption timelines. At least one commenter suggested that we did not identify current private investment plans in the NPRM. In general, there was a sentiment from these commenters that more support for commercial facilities is necessary, and commenters urged Federal agencies to align resources and goals to ensure that buildout happens in a coordinated fashion and at a necessary pace.

Industry commenters anticipated lead time issues beyond their control. Several manufacturers suggested adjusting the standards in the case of unexpectedly slow infrastructure development, and there were calls to regularly evaluate infrastructure deployment and establish annual benchmarks for assessing progress.

In response to comments, we re-evaluated our assumptions about the retail price of hydrogen, in consultation with DOE, along with FCEV technology-related costs (see RIA Chapter 2.5). Our revised projections for HD FCEV adoption are based on relatively low production volumes in the MY 2030 to 2032 timeframe, indicative of an early market technology rollout. As a result, our hydrogen consumption estimates in the NPRM of about 830,000 metric tons of hydrogen per year in 2032 dropped in the final rule to about 130,000 metric tons of hydrogen per year by 2032, or 1.3 percent of current production. Our assessment is that early market buildout of a hydrogen refueling station network to support modest FCEV adoption levels in the modeled potential compliance pathway is feasible in the 2030 to 2032 timeframe. We are not suggesting that a full national hydrogen infrastructure network needs to be in place by 2030 or 2032, as implied by a few commenters, and specifically note that a full national hydrogen infrastructure network is not necessary to accommodate the demand that we posit for HD FCEVs in our modeled potential compliance pathway. This is further explained in RTC section 8.1.

In addition to the billions of dollars in Federal investment already referenced, RIA Chapter 1.7.5 includes information about known private investments in HD FCEVs and hydrogen infrastructure. According to CIPHER's Clean Technology Tracker, as of September 2023, there is \$45.752 billion in total clean hydrogen production project investment in the United

States,<sup>563</sup> with 1 percent in projects that are in operation (close to \$500,000), 7 percent (\$3.2 million) under construction, and a majority still classified as announced.<sup>564</sup> DOE is tracking private sector announcements of domestic electrolyzers and fuel cell manufacturing facilities. So far, over \$1.8 billion in new investments has been announced for over 10 new or expanded facilities with the capacity to manufacture approximately 10 GW of electrolyzers per year.<sup>565</sup> BIL and IRA programs are under ongoing development, but we anticipate that investment strategies (e.g., that connect producers of hydrogen with end users of fuel) will amplify and become clearer in the near term. We also expect this rule will provide greater certainty to the market to support timely development of hydrogen refueling stations.

Given that hydrogen refueling infrastructure for HD FCEVs is developing, we also reviewed literature that assesses hydrogen infrastructure needs for the HD transportation sector, as discussed further in RIA Chapter 1.8.3.5. The authors used differing analytical approaches and a large range of assumptions about the production, distribution and storage, and dispensing of hydrogen fuel to estimate hydrogen demand for HD FCEVs and the number of refueling stations required to meet that demand. Several papers examined infrastructure costs in the 2030 timeframe, as discussed further in Chapter 2.5.3.1. In general, the authors concluded that economies of scale are important to reduce costs throughout the supply chain. Most researchers of papers that we reviewed agree that it is not necessary to build a national infrastructure network for HD FCEVs all at once. Station financial prospects can vary by region and tend to be more favorable in areas with higher demand (i.e., high energy needs from HD traffic flows), while station costs are anticipated to drop with growth in demand and related economies of scale. Similar to BEVs, as explained in RTC section 7.1, the infrastructure needed to meet this initial demand may be

<sup>563</sup> According to the Clean Technology Tracker, clean hydrogen production refers to the production of hydrogen fuel with proton exchange membrane (PEM) electrolyzers and solid oxide electrolyzer cells (SOEC) or through other methods such as methane pyrolysis and natural gas with carbon capture.

<sup>564</sup> Cipher News. "Tracking a new era of climate solutions: Cleantech growth across the U.S." Accessed February 2024. Available online: <https://ciphernews.com/cleantech-tracker/#definitions>.

<sup>565</sup> U.S. Department of Energy. "Building America's Clean Energy Future—Hydrogen: Electrolyzers and Fuel Cells". Accessed February 2024. Available online: <https://www.energy.gov/invest>.

centered in a discrete sub-set of states and counties where freight activity is concentrated. Thus, the select vehicle applications for which we project FCEV adoption could start traveling within or between regional hubs in this timeframe where hydrogen development is prioritized initially.

Along these lines, in March 2024, the U.S. released a National Zero-Emission Freight Corridor Strategy<sup>566</sup> that "sets an actionable vision and comprehensive approach to accelerating the deployment of a world-class, zero-emission freight network across the United States by 2040. The strategy focuses on advancing the deployment of zero-emission medium- and heavy-duty vehicle (ZE-MHDV) fueling infrastructure by targeting public investment to amplify private sector momentum, focus utility and regulatory energy planning, align industry activity, and mobilize communities for clean transportation."<sup>567</sup> The strategy has four phases. The first phase, from 2024–2027, focuses on establishing freight hubs defined "as a 100-mile to a 150-mile radius zone or geographic area centered around a point with a significant concentration of freight volume (e.g., ports, intermodal facilities, and truck parking), that supports a broader ecosystem of freight activity throughout that zone."<sup>568</sup> The second phase, from 2027–2030, will connect key ZEV hubs, building out infrastructure along several major highways. The third phase, from 2030–2045, will expand the corridors, "including access to charging and fueling to all coastal ports and their surrounding freight ecosystems for short-haul and regional operations."<sup>569</sup> The fourth phase, from 2035–2040, will complete the freight corridor network. This corridor strategy provides further support for the development of HD ZEV infrastructure that corresponds to the

<sup>566</sup> Joint Office of Energy and Transportation. "National Zero-Emission Freight Corridor Strategy" DOE/EE–2816 2024. March 2024. Available at <https://driveelectric.gov/files/zef-corridor-strategy.pdf>.

<sup>567</sup> Joint Office of Energy and Transportation. "Biden-Harris Administration, Joint Office of Energy and Transportation Release Strategy to Accelerate Zero-Emission Freight Infrastructure Deployment." March 12, 2024. Available online: <https://driveelectric.gov/news/decarbonize-freight>.

<sup>568</sup> Joint Office of Energy and Transportation. "National Zero-Emission Freight Corridor Strategy" DOE/EE–2816 2024. March 2024. Available at <https://driveelectric.gov/files/zef-corridor-strategy.pdf>. See page 3.

<sup>569</sup> Joint Office of Energy and Transportation. "National Zero-Emission Freight Corridor Strategy" DOE/EE–2816 2024. March 2024. Available at <https://driveelectric.gov/files/zef-corridor-strategy.pdf>. See page 8.

modeled potential compliance pathway for meeting the final standards.

The literature also further supports that there is sufficient lead time. Fulton et. al. noted that heavy-duty refueling station funding, design, and planning should start one to two years before deployment.<sup>570</sup> The Coordinating Research Council noted that full station development (*i.e.*, design, permitting, construction, and commissioning) takes about two years, assuming no major hurdles.<sup>571</sup> The California Energy Commission has evaluated hydrogen refueling station development in California since 2010. Their planned network of 200 stations is mainly for light-duty vehicles but has at least 13 stations with the capability to serve HD FCEVs.<sup>572</sup> Station development times have generally decreased over time, from a median or typical time spent of around 1,500 days in 2010 to about 500 days in 2019 (*i.e.*, about two years if considering business days) for projects that have completed all phases of development.<sup>573</sup> They expect some increase in median development times as projects delayed by the COVID-19 pandemic are completed but regularly monitor progress and work to improve the deployment process.<sup>574</sup>

We recognize that these plans will require sustained support to come to fruition, and our assessment, in consultation with relevant Federal agencies, is that our projections are supported and correspond to our measured approach in our modeled compliance pathway for FCEVs. There

<sup>570</sup> Fulton, et. al. "California Hydrogen Analysis Project: The Future Role of Hydrogen in a Carbon-Neutral California—Final Synthesis Modeling Report". UC Davis Institute of Transportation Studies. April 19, 2023. Available online: <https://escholarship.org/uc/item/27m7g841>.

<sup>571</sup> Coordinating Research Council, Inc. "Assess the Battery-Recharging and Hydrogen-Refueling Infrastructure Needs, Costs, and Timelines Required to Support Regulatory Requirements for Light-, Medium-, and Heavy-Duty Zero-Emission Vehicles: Final Report". Prepared by ICF. CRC Report No. SM-CR-9. September 2023. Available online: [https://crao.org/wp-content/uploads/2023/09/CRC\\_Infrastructure\\_Assessment\\_Report\\_ICF\\_09282023\\_Final-Report.pdf](https://crao.org/wp-content/uploads/2023/09/CRC_Infrastructure_Assessment_Report_ICF_09282023_Final-Report.pdf).

<sup>572</sup> The CEC has invested nearly \$40 million in medium- and heavy-duty hydrogen infrastructure.

<sup>573</sup> Berner, et al. "Joint Agency Staff Report on Assembly Bill 8: 2022 Annual Assessment of Time and Cost Needed to Attain 100 Hydrogen Refueling Stations in California". California Energy Commission & California Air Resources Board. December 2022. Available online: <https://www.energy.ca.gov/sites/default/files/2022-12/CEC-600-2022-064.pdf>.

<sup>574</sup> Berner, et al. "Joint Agency Staff Report on Assembly Bill 8: 2022 Annual Assessment of Time and Cost Needed to Attain 100 Hydrogen Refueling Stations in California". California Energy Commission & California Air Resources Board. December 2022. Available online: <https://www.energy.ca.gov/sites/default/files/2022-12/CEC-600-2022-064.pdf>.

are many complex factors at play, and we have taken a close look at how the ramp-up period over the next decade is critical. In our modeled potential compliance pathway, we evaluated the existing and projected future hydrogen refueling infrastructure and considered FCEVs only in the MY 2030 and later timeframe to better ensure that our compliance pathway provides adequate time for early market infrastructure development. We conclude that a phased and targeted approach can offer sufficient lead time to meet the projected refueling needs that correspond to the technology packages for the final rule's modeled potential compliance pathway, as further discussed in RIA Chapter 2.1. Additionally, EPA is committed to ensuring the Phase 3 program is successfully implemented, and as described in preamble section II.B.2.iii, in consideration of concerns raised regarding inherent uncertainties about the future, we are including a commitment to monitor progress on hydrogen refueling infrastructure development in the final rule.

#### 4. Summary of Technology Assessment

In prior HD GHG rulemakings, EPA promulgated standards that could feasibly be met through technological improvements in many areas of the vehicle. For example, as discussed in section II.C, the HD GHG Phase 2 CO<sub>2</sub> emission standards were premised on technologies such as engine improvements, advanced transmissions, advanced aerodynamics and, in some cases, hybrid powertrains. We evaluated each technology's effectiveness as demonstrated over the regulatory duty cycles using EPA's GEM and estimated the appropriate projected adoption rate of each technology.<sup>575</sup> We then developed a technology package for each of the regulatory subcategories, which represented a potential compliance pathway to support the feasibility of the Phase 2 standards. We are following a similar approach in this Phase 3 final rule.

In the HD GHG Phase 2 final rule, we included ZEV technologies in our assessment of the suite of technologies for HD vocational vehicles and tractors. However, in 2016, when the HD GHG Phase 2 rule was being developed, we stated that "adoption rates for these advanced technologies in heavy-duty vehicles are essentially non-existent

<sup>575</sup> GEM is an EPA vehicle simulation tool used to certify HD vehicles. A detailed description of GEM can be found in the RIA for the HD GHG Phase 2 rulemaking, available at <https://nepis.epa.gov/Exe/ZyPDF.cgi/P100P7NS.PDF?Dockey=P100P7NS.PDF>.

today and seem unlikely to grow significantly within the next decade without additional incentives."<sup>576</sup> Thus, at that time, instead of including ZEV technologies in the technology packages for setting the Phase 2 standards, we provided advanced technology credit multipliers to help incentivize the development of such technologies, as well as PHEVs, because they had the potential for very large GHG emission reductions.

Since the 2016 promulgation of the HD GHG Phase 2 final rule, as discussed in section I.C of this preamble, several important factors have contributed to changes in the HD landscape. Therefore, as detailed in this section II and RIA Chapter 2, our assessment concludes that ICE technologies, BEV technologies and FCEV technologies will be technically feasible for HD motor vehicles, as assessed by vehicle type and each Phase 3 MY. Similar to Phase 1 and Phase 2, the technology packages used to support the feasibility of the standards in this final rule include a mix of technologies applied to HD motor vehicles, and development of those technology packages included an assessment of the projected feasibility of the development and application of BEV, FCEV, and other technologies that reduce GHG emissions from HD ICE vehicles. While our analysis in this section II.D focuses on certain technologies in the technology packages as a potential compliance pathway to support the feasibility of the final HD vehicle GHG emission standards, there are other technologies that can reduce CO<sub>2</sub> emissions and other example potential compliance pathways to meet the standards as discussed in RIA Chapters 1 and 2.11 and section II.F.4. Under the final rule, manufacturers may choose to utilize the technologies that work best for their business case and for the operator's needs in meeting the final standards. We reiterate that the standards are performance-based and do not mandate any specific technology for any manufacturer or any vehicle subcategory.

The range of GHG emission-reducing technologies for HD vehicles considered in this final rulemaking include those for HD vehicles with ICE (section II.D.1), HD BEVs (section II.D.2), and HD FCEVs (section II.D.3). For evaluating the BEV and FCEV technologies portion of the range for this analysis, for this rulemaking EPA developed a bottom-up approach to estimate the operational characteristics and costs of such technologies. As explained in the NPRM, we developed a new technology

<sup>576</sup> 81 FR 73498 (October 25, 2016).

assessment tool, Heavy-Duty Technology Resource Use Case Scenario (HD TRUCS), to evaluate the design features needed to meet the energy and power demands of HD vehicle types when using different technologies, and comparing resulting manufacturing, operating and purchasing costs. In this rulemaking, we used HD TRUCS to assess the design features to meet the power and energy demands of various HD vehicles when using ZEV technologies, as well as costs related to manufacturing, purchasing and operating ICE vehicle and ZEV technologies. We chose to analyze the comparison with ZEV technologies for the modeled potential compliance pathway as the technology capable of achieving the greatest vehicle GHG emission reductions. Furthermore, we made a number of updates to HD TRUCS for the final rulemaking to reflect consideration of new information, including that received in comments. HD TRUCS is described in more detail in section II.D.5 and RIA Chapter 2, but we briefly summarize the approach here.

To use HD TRUCS as part of building the technology packages to support the feasibility of the standards, we created 101 representative HD vehicles that cover the full range of weight classes within the scope of this rulemaking (Class 2b through 8 vocational vehicles and tractors). The representative vehicles cover many aspects of work performed by HDVs. This work was translated into energy and power demands per vehicle type based on everyday use of HD vehicles, ranging from moving goods and people to mixing cement. We then identified the technical properties required for a BEV or FCEV to meet the operational needs of a comparable ICE vehicle.<sup>577</sup>

Since batteries can add weight and volume to a vehicle,<sup>578</sup> we evaluated battery mass and physical volume required to package a battery pack. If the performance needs of a BEV resulted in a battery that was too large or heavy, then we did not consider the BEV for

<sup>577</sup> Heavy-duty vehicles are typically powered by a diesel-fueled compression-ignition (CI) engine, though the heavy-duty market includes vehicles powered by gasoline-fueled spark-ignition (SI) engines and alternative-fueled ICEs. We selected diesel-powered ICE vehicles as the baseline vehicle for the assessment in HD TRUCS in our analysis because a diesel-fueled CI engine is broadly available for all of the 101 vehicle types.

<sup>578</sup> Smith, David et. al. "Medium- and Heavy-Duty Vehicle Electrification: An Assessment of Technology and Knowledge Gaps". U.S. Department of Energy: Oak Ridge National Laboratory and National Renewable Energy Laboratory. December 2019. Available online: <https://info.ornl.gov/sites/publications/Files/Pub136575.pdf>.

that application in our technology package because of, for example, the impact on payload and, thus, potential work accomplished relative to a comparable ICE vehicle.<sup>579</sup>

To evaluate costs for these technologies, including costs of compliance for manufacturers using this compliance pathway as well as user costs related to purchasing and operating ZEVs, we sized vehicle components that are unique to ZEVs to meet the work demands of each representative vehicle. We applied cost estimates to each vehicle component based on sizing to assess the difference in total powertrain costs between the ICE and ZEV powertrains. We accounted for the IRA battery tax credit and vehicle tax credit, as discussed in section II.E.4. We also compared operating costs due to fuel consumption, vehicle maintenance and repair, and insurance. We also included the upfront cost to procure and install depot charging infrastructure for certain BEVs. Costs of the needed distribution grid buildout infrastructure are reflected in the per kilowatt hour price of electricity used for both depot and public charging. For the BEVs where we project their charging needs will be met by public charging, instead of including the charging infrastructure costs upfront, we included these amortized costs in the charging cost in addition to the cost of electricity, demand charges, and EVSE maintenance costs. We took a similar approach for FCEVs, where we embedded the hydrogen infrastructure costs into the cost of hydrogen fuel. This approach is consistent with our assessment of fueling costs associated with ICE vehicles where the fuel station infrastructure costs are included in the per gallon price of fuel.

We relied on research and findings discussed in RIA Chapters 1 and 2 to conduct this analysis. For MYs 2027 through 2029, for the BEV and FCEV technologies portions of the analysis, we focused primarily on BEV technology using depot charging. Consistent with our analysis, research shows that some BEV technologies can become cost-competitive in terms of total cost of ownership for many HD vehicles by the late 2020s, but it will take longer for FCEVs.<sup>580 581 582</sup> Given that there are

<sup>579</sup> This does not necessarily mean that a BEV with a large battery weight and volume would not be technically feasible for a given HD vehicle use, but rather this is an acknowledgement that we considered impacts of increased battery size on feasibility considerations like payload capacity as well as cost and payback within the selection of HD vehicle technologies for the technology packages.

<sup>580</sup> Ledna et. al. "Decarbonizing Medium- & Heavy-Duty On-Road Vehicles: Zero-Emission

more BEV models available today compared to FCEV models (see, e.g., RIA Chapters 1.7.5 and 1.7.6), we project in our technology packages that BEV technology adoption is likely to happen sooner than the adoption of FCEV technology. Also, as discussed in RIA Chapter 1.6, we project that depot charging will occur at a faster rate than the development of a HD public charging network. Therefore, the modeled potential compliance pathway focuses on these types of BEVs in the initial Phase 3 MYs.

Starting in MY 2030, we also considered FCEV technology using public refueling infrastructure and BEVs using public charging for select applications in our modeled compliance pathway and H2-ICE using public refueling infrastructure in our additional example potential compliance pathways. BEV technology is more energy efficient than FCEV technology but may not be suitable for all applications during the model years at issue in this rulemaking, such as when the performance needs result in additional battery mass that prohibitively affects payload. In cases like this, the pathway considered either BEVs with smaller batteries, that may require enroute charging and the consequent use of public charging away from the depot, or FCEVs, which may have shorter refueling times than BEVs with large batteries.<sup>583 584</sup> We considered FCEVs and BEVs using public charging in the technology packages for applications that travel longer distances and/or carry heavier loads (i.e., for those that may be sensitive to refueling times

Vehicles Cost Analysis". U.S. Department of Energy, National Renewable Energy Laboratory. March 2022. Available online: <https://www.nrel.gov/docs/fy22osti/82081.pdf>.

<sup>581</sup> Hall, Dale and Nic Lutsey. "Estimating the Infrastructure Needs and Costs for the Launch of Zero-Emission Trucks". White Paper: The International Council on Clean Transportation. August 2019. Available online: [https://theicct.org/wp-content/uploads/2021/06/ICCT\\_EV\\_HDVs\\_Infrastructure\\_20190809.pdf](https://theicct.org/wp-content/uploads/2021/06/ICCT_EV_HDVs_Infrastructure_20190809.pdf).

<sup>582</sup> Robo, Ellen and Dave Seamonds. Technical Memo to Environmental Defense Fund: Investment Reduction Act Supplemental Assessment: Analysis of Alternative Medium- and Heavy-Duty Zero-Emission Vehicle Business-As-Usual Scenarios. ERM. August 19, 2022. Available online: <https://www.erm.com/contentassets/154d08e0d0674752925cd82c66b3e2b1/edf-zev-baseline-technical-memo-addendum.pdf>.

<sup>583</sup> A technology is more energy efficient if it uses less energy to do the same amount of work. Energy can be lost as it moves through the vehicle's components due to heat and friction.

<sup>584</sup> Cunanan, Carlo et. al. "A Review of Heavy-Duty Vehicle Powertrain Technologies: Diesel Engine Vehicles, Battery Electric Vehicles, and Hydrogen Fuel Cell Electric Vehicles". *Clean Technol.* Available online: <https://www.mdpi.com/2571-8797/3/2/28>.



or payload impacts). These included some coach buses and tractors.

After considering operational characteristics and costs in 2022\$, for the BEV and FCEV technologies portions of the analysis, we determined the payback period, which is the number of years it would take to offset any incremental cost increase of a ZEV over a comparable ICE vehicle. Next, the inclusion of BEV and FCEV technologies in the technology packages as a potential compliance pathway that support the feasibility of the final standards was determined after considering the payback period for BEVs or FCEVs.

Lastly, the modeled potential compliance pathway that supports the final standards is a combination of the ICE vehicle technologies described in section II.D.1 along with BEV and FCEV technologies. As stated in section II.D.1 of this preamble, for the ICE vehicle technologies part of the analysis that supports the feasibility of the Phase 3 standards, our assessment is that the technology packages for the modeled potential compliance pathway include a mix of ICE vehicle technologies and adoption rates of those technologies at the levels included in the Phase 2 MY 2027 technology packages. Additionally, for the additional example potential compliance pathways that support the feasibility of the Phase 3 standards, our assessment is that those technology packages include a mix of vehicles with ICE technologies described in section II.D.1 and further discussed in section II.F.4 and adoption rates of those technologies at the levels described in section II.F.4.

#### 5. EPA's HD TRUCS Analysis Tool

For the final rule, EPA further refined HD TRUCS, which (as just noted) was developed by EPA to evaluate the design features needed to meet the energy and power demands of various HD vehicle types when using ZEV technologies. We did this by sizing the

BEV and FCEV components such that they could meet the driving demands based (in most instances) on the 90th percentile daily VMT for each application, while also accounting for the heating, ventilation, and air conditioning (HVAC) and battery thermal conditioning load requirements in hot and cold weather and any PTO demands for the vehicle. Furthermore, we accounted for the fact that the usable battery capacity is less than 100 percent and that batteries deteriorate over time. We also sized the ZEV powertrains to ensure that the vehicles would meet an acceptable level of acceleration from a stop and be able to maintain a cruise speed while going up a hill at six-percent grade. In this subsection, we discuss the primary inputs used in HD TRUCS along with the revisions made for the tool used in this final rulemaking. Additional details on HD TRUCS can be found in RIA Chapter 2. We received numerous comments on our approach to HD TRUCS; some key topic themes include, but are not limited to, vehicle sales distribution, battery sizing method, component efficiencies and costs, additional operating costs, EVSE costs and dwell time, payback curve, alternative sources for inputs and the feasibility of ZEVs. We also addressed the minor errors in inputs for a few of the 101 vehicles noted by one commenter.

#### i. Vehicles Analyzed

The version of HD TRUCS supporting this final rule continues to analyze 101 vehicle types. However, we refined certain inputs based on consideration of comments received. The 101 vehicle types encompass 22 different applications in the HD vehicle market, as shown in Table II–10. These vehicles applications are further differentiated by weight class, duty cycle, and daily VMT for each of these vehicle applications into 101 vehicle types. These 101 vehicle types cover all 33 of the heavy-duty regulatory subcategories, as shown

in RIA Chapter 2.8.3.1. As explained at proposal, 88 FR 25974, the initial list of HD TRUCS vehicles contained 87 vehicle types and was based on work the Truck and Engine Manufacturers Association (EMA) and CARB conducted for CARB's ACT rule.<sup>585</sup> For the NPRM, we consolidated the list; eliminated some of the more unique vehicles with small populations like mobile laboratories; and assigned operational characteristics for vocational vehicles that correspond to the Urban, Multi-Purpose, and Regional duty cycles used in GEM. We also added additional vehicle types to reflect vehicle applications that were represented in EPA's certification data. Chapter 2.1 of the RIA summarizes the 101 unique vehicle types represented in HD TRUCS and each with a vehicle identifier, along with their corresponding regulatory subcategory, vehicle application, vehicle weight class, MOVES SourceTypeID and RegClassID,<sup>586</sup> and GEM duty cycle category. After considering comments, we revised several HD vehicles to increase the number of day cab vehicle types and sleeper cab vehicle types within the final rule version of HD TRUCS to include four day cabs vehicle types and three sleeper cabs vehicle types that are modeled in our analysis to use public charging, starting in MY 2030. In addition, of the tractors vehicle types that were designed for public charging one day cab and one sleeper cab were updated to reflect a more aerodynamic tractor design than the average tractor aerodynamics used in the technology assessment to support the Phase 2 standards. See RIA 2.2.2.1 for additional details.

<sup>585</sup> California Air Resources Board, Appendix E: Zero Emission Truck Market Assessment (2019), available at <https://ww2.arb.ca.gov/sites/default/files/barcu/regact/2019/act2019/appe.pdf> (last accessed on September 26, 2022).

<sup>586</sup> MOVES homepage: <https://www.epa.gov/moves> (last accessed October 2022).

**Table II-10 HD Vehicle Applications Included in HD TRUCS**

Ambulance	Shuttle Bus
Box Truck	Snow Plow
Cement Mixer/Pumper	Step Van
Coach Bus	Street Sweeper
Dump Truck	Tanker Truck
Fire Truck	Tow Truck
Flatbed/Stake Truck	Tractor, Day Cab
Port Drayage Tractor	Tractor, Sleeper Cab
Refuse Truck	Transit Bus
RV	Utility Truck
School Bus	Yard Tractor

Heavy-duty vehicles are typically powered by a diesel-fueled CI engine, though the heavy-duty market also includes vehicles powered by gasoline-fueled SI engines and alternative-fueled ICE. We selected diesel-powered ICE vehicles as the baseline vehicle for the assessment in HD TRUCS in our analysis because a diesel-fueled CI engine is broadly available for all of the 101 vehicle types and is more efficient than an SI engine. Chapter 2.2 of the RIA includes the details we developed for each of the baseline vehicles, including the size of the engine and the transmission type. This information was used to determine the weight and the cost of the ICE powertrains.

As noted, in the ZEV technologies portion of our analysis for our projected technology packages, for MYs 2027 through 2029, we primarily considered BEV technologies using depot charging. Starting in MY 2030, we also considered FCEV technologies for select applications that travel longer distances and/or carry heavier loads. This included coach buses, sleeper cab tractors, and day cab tractors that are designed to travel longer distances. For the final rule, we agree with commenters who maintained that public charging would be needed for certain BEV applications with high VMT. In our analysis, we are now projecting (and including costs for) these applications to utilize public charging, starting in MY 2030. We also updated one day cab tractor and one sleeper cab tractor that utilize public charging to reflect a more aerodynamic design than the average tractor aerodynamics used in the technology assessment to support the

Phase 2 standards. This was done to reflect the reality that a newly designed HD BEV that is currently available on the market has a more aerodynamic design than tractors used in setting the Phase 2 standards. For more discussion on the specifics of the aerodynamic tractors, see RIA Chapter 2.2.2.1.

ii. Vehicle Energy Demand

Energy is necessary to perform the work required of the vehicle. This work includes driving, idling, and providing heating and cooling; in addition, some vehicles require energy to operate equipment. Vehicles with regenerative braking systems have the opportunity to recover some of the kinetic energy that would otherwise be lost during braking. There are a wide variety of energy demands across the heavy-duty sector, depending on the vehicle's application. For example, some vehicles, such as long-haul tractors, spend the vast majority of the time driving, a fraction of the time idling, and require heating and cooling of the cabin, but do not require operation of additional equipment. A transit bus typically operates at low speeds, so it requires less energy for driving than a long-haul tractor, but requires more energy for heating or cooling due to its large amount of interior cabin volume. Unlike ICE vehicles where the cabin heating is often provided by excess heat from the main ICE, BEVs do not have excess heat from an ICE to utilize in this manner and thus require more energy than ICE vehicles to heat the cabin and additional energy to manage the temperature of the batteries. As another example of the wide variety of energy demands for HD

vehicles, a utility truck, also known as a bucket truck, may only drive a few miles to a worksite while idling for the majority of the day and using energy to move the bucket up and down. The power to run the separate equipment on ICE vehicles is typically provided by a PTO from the main engine.

In HD TRUCS, we determined the daily energy demand for each of the 101 vehicle types by estimating both the baseline energy demands that are similar regardless of the powertrain configuration and the energy demands that vary by powertrain. The baseline energy includes energy at the axle to move the vehicle, energy recovered from regenerative braking energy, and PTO energy. Powertrain-specific energy includes energy required to condition the battery and heat or cool the cabin using HVAC system. We discuss each of these in the following subsections.

a. Baseline Energy

For each HD TRUCS vehicle type, we determined the baseline energy consumption requirement that is needed for each of the HD TRUCS applications for ZEVs. The amount of energy needed at the axle to move the vehicle down the road is determined by a combination of the type of drive cycle (such as urban or freeway driving) and the number of miles traveled over a period of time. To do this, we used the drive cycles and cycle weightings adopted for HD GHG Phase 2 for our assessment of the energy required per mile for each vehicle type. EPA's GEM model simulates road load power requirements for various duty cycles to estimate the energy required per mile for HD vehicles. To understand

the existing heavy-duty industry, we performed an analysis on current heavy-duty vehicles in the market in order to determine typical power requirements and rates of energy consumption at the axle. These values represent the energy required to propel a vehicle of a given weight, frontal area, and tire rolling resistance to complete the specified duty cycle on a per-mile basis, independent of the powertrain. In RIA Chapter 2.2.2, we describe the GEM inputs and results used to estimate the propulsion energy and power requirements at the axle for ICE vehicles on a per-mile basis. We also used these inputs, along with some simple electric vehicle assumptions, to develop a model to calculate weighted percent of energy recovery due to regenerative braking. Additional detail can be found in RIA Chapter 2.2.2.1.3.

We requested data on our propulsion and regenerative braking energy assessment in the proposal. We received comment that dump trucks, for example, haul loads greater than the payload evaluated in GEM to determine the propulsion power. It is worth noting that the payload used in GEM to determine power requirements represents an average payload with the expectation that vocational vehicles, like dump trucks, would deliver a load and then return with an empty vehicle. Therefore, the payload evaluated for Class 8 dump trucks is essentially 30,000 pounds on one leg of the trip and zero pounds for the other leg of the trip. Furthermore, as discussed in section II.F, we reduced the stringency of the final standards for heavy heavy-duty vocational vehicles from the values proposed to reflect challenging applications, such as this one.

As noted, some vocational vehicles have attachments that perform work, typically by powering a hydraulic pump, which are powered by PTOs. Information on in-use PTO energy demand cycles is limited. NREL published two papers describing investigative work into PTO usage and fuel consumption.<sup>587</sup> These studies, however, were limited to electric utility vehicles, such as bucket trucks and material handlers. To account for PTO usage in HD TRUCS, we chose to rely on a table described in California's Diesel Tax Fuel Regulations, specifically in Regulation 1432, "Other

Nontaxable Uses of Diesel Fuel in a Motor Vehicle,"<sup>589</sup> that covers a wider range of vehicles beyond the electric utility vehicles in the referenced NREL studies. This table contains "safe-harbor" percentages that are presumed amounts of diesel fuel used for "auxiliary equipment" operated from the same fuel tank as the motor vehicle. We used this source to estimate PTO energy use as a function of total fuel consumed by vehicle type, as discussed in RIA Chapter 2.2.2.1.4. We requested data for PTO loads in the NPRM and received some comments on our approach for analyzing PTO demands. Specifically, we received data for cement mixers and cement pumpers suggesting that our PTO loads used for these vehicles in the NPRM were too low. After investigation, we agree, and have increased the PTO demand for cement mixers and pumpers.

Within HD TRUCS, we calculated the total energy needed daily based on a daily VMT for each vehicle type. We used multiple sources to develop the VMT for each vehicle including the NREL FleetDNA database, a University of California-Riverside (UCR) database, the 2002 Vehicle Inventory and Use Survey (VIUS), the CARB Large Entity Report, or an independent source specific to an application, as discussed in RIA Chapter 2.2.1.2.<sup>590</sup> EPA assigned each vehicle type a 50th percentile average daily VMT<sup>591</sup> ("operational VMT") that was used to estimate operational costs, such as average annual fuel, hydrogen, or electricity costs, and maintenance and repair costs (see RIA Chapters 2.3.4, 2.4.4, and 2.5.3). We also account for the change in use of the vehicle over the course of its ownership and operation in HD TRUCS by applying a VMT ratio based

on vehicle age to the 50th percentile VMT. The cost of fuel consumption for a particular calendar year is determined by the VMT traveled for that year and the fuel price in that year.

For the proposal, we also developed a 90th percentile daily VMT ("sizing VMT") and used it in HD TRUCS to size ZEV components such as batteries and to estimate the size requirements for EVSE. We selected the 90th percentile daily VMT data because we project that manufacturers will design their BEVs to meet most daily VMT needs, but not to meet the most extreme operations. BEVs designed to meet the longest daily VMT of all operators would be unnecessarily heavy and expensive for most operations, which would limit their appeal.

Commenters challenged EPA's choices for both sizing and operational VMT, as well as the combination of 90th percentile sizing VMT with 50th percentile operational VMT. The first question is the mileage to which a percentile is applied. EPA based its mileage estimate on the NREL's FleetDNA and the UC Riverside's databases, which provide nationwide estimates covering the widest range of HDVs.<sup>592</sup> Two commenters recommended lower VMT using different sources of telematics data (including 2002 VIUS data, and data used by CARB in support of its ACT rule). Another commenter, on the other hand, claimed that EPA's estimate was low and supported its claim with recent (May 2023) telematics data from its own fleet operations which had a 90th percentile VMT considerably higher than that in the NREL FleetDNA data base. See RIA Chapter 2.2.1.2.2 for additional discussion.

Irrespective of mileage, one commenter maintained that the combination of a 90th percentile sizing VMT and 50th percentile operational VMT was inherently overconservative. Sizing a battery at the 90th percentile, in their view, is the equivalent of foisting unneeded capacity on a purchaser when operational VMT is at the 50th percentile. There is no reason, in that commenter's view, for the analysis to posit purchasers buying more battery capacity than they need, and for the analysis to assume that extra battery cost. In addition, the commenter asserted that 50th percentile VMT skews EPA's payback analysis toward longer payback periods, since it results in longer time in the analysis for

<sup>587</sup> NREL, Characterization of PTO and Idle Behavior for Utility Vehicles, Sept 2017. Available online: <https://www.nrel.gov/docs/fy17osti/66747.pdf>.

<sup>588</sup> NREL, Fuel and Emissions Reduction in Electric Power Take-Off Equipped Utility Vehicles, June 2016. Available online: <https://www.nrel.gov/docs/fy17osti/66737.pdf>.

<sup>589</sup> See 18 CCR section 1432, "Other Nontaxable Uses of Diesel Fuel in a Motor Vehicle," available at <https://www.cdtda.ca.gov/lawguides/vol3/dftr/dftr-reg1432.html>.

<sup>590</sup> NREL and EPA. Heavy-Duty Vehicle Activity for EPA MOVES. Available at <https://data.nrel.gov/submissions/168>, last accessed on October 15, 2022, which includes an assessment of both the NREL and UC-Riverside databases; U.S. Census Bureau. 2002 Vehicle Inventory and Use Survey. <https://www.census.gov/library/publications/2002/econ/census/vehicle-inventory-and-use-survey.html>, last accessed on October 15, 2022. CARB. Large Entity Reporting. Available at <https://ww2.arb.ca.gov/our-work/programs/advanced-clean-trucks/large-entity-reporting>.

<sup>591</sup> We used the 50th percentile as a proxy for average VMT from the NREL FleetDNA database and the UC-Riverside database. The NREL and UC-Riverside databases each contained a selection of vehicles that we used to calculate 50th and 90th percentile daily VMT. When each database had a VMT value, the values were averaged to get VMT for a specific market segment. See RIA Chapter 2.2.1.2 for further details. See text addressing comments that these mileage estimates are not representative.

<sup>592</sup> NREL and EPA. Heavy-Duty Vehicle Activity for EPA MOVES. Available at <https://data.nrel.gov/submissions/168>, last accessed on October 15, 2022, which includes an assessment of both the NREL and UC-Riverside databases.

operational and maintenance savings to be realized. In addition, some commenters were skeptical that a 90th percentile sizing VMT properly reflects the existing market where vehicles typically select different sized batteries for different range requirements.

Other commenters challenged the sizing VMT as too low. They question whether purchasers would buy a vehicle unsuitable for a portion of their operations (at least 10 percent, accepting EPA's mileage estimate). In their view, fleets would only purchase 90th percentile trucks if they had exceptionally high confidence that their vehicle will see predictable routes and weights that fall within that 90th percentile operating window. As noted, one commenter also submitted data challenging the mileage estimate itself.

Other comments were less specific, alleging more generally that heavy-duty vehicles travel more miles than reflected in EPA's analysis. These comments expressed concerns about the range of current BEVs and how the range of current BEV applications fail to match the range of corresponding ICE vehicles. For example, one commenter raised a concern that range for one EV was reported at 150 miles when compared to a comparable diesel vehicle with a range of 1,000 miles. Another commenter questioned the purchasers' willingness to accept vehicles with low range, such as the vehicles EPA included in the NPRM which had ranges with less than 100 miles. Another commenter was concerned about the availability of different models with 200 miles of range. Two other commenters were concerned about additional trips or more work required due to limited battery range and long charging times which can be affected by ambient temperature and road grade, among other factors. They also stated that these factors contribute to reduced efficiency in the trucking industry requiring additional trucks, drivers, and trips to deliver the same amount of freight.

EPA appreciates the comments that raised concern about the range of BEVs. We used 101 vehicles to represent the HD industry and our list of vehicles covers the vast majority of vehicle applications, but we recognize it is not all-encompassing. Our technology packages project that significant volumes of ICE vehicles will be sold in the timeframe of this rule and that those vehicles will be used in applications that see extremes, whether they be extreme daily VMT or extreme ambient temperatures, or niche applications. Hence the assumption of 90th percentile sizing VMT because battery sizes to meet longer daily VMTs would be

unnecessarily large for most applications. For vehicles using depot charging, one of the base assumptions for the battery sizing analysis was to complete one day's worth of work on a single charge. Therefore, our basic premise was to size ZEVs and ZEV batteries so that they could perform the majority of work that ICE vehicles are capable of and to analyze the payback based on the average fleet daily VMT. This ensures that the vehicles specified in HD TRUCS are capable of doing the work performed by ICE vehicles. At the same time, an operational VMT at the 50th percentile is a conservative but reasonable means of evaluating payback. By using the 50th percentile, we are saying there will be days where the vehicle is used less and days when it's used more, but on average this value would be representative of the typical day. Consequently, we do not agree with the commenters' assertion that the combination of sizing and operational VMTs in HD TRUCS is arbitrary.

For the final rule, we are continuing to size our vehicles batteries for depot charging BEVs to the 90th percentile as this percentile would cover the majority of fleet operations. Sizing vehicle batteries to the 50th percentile, as suggested by some commenters, would decrease the number of years it would take for the BEV technology to pay back, but it would also mean that these ZEVs would be unavailable for major market segments in our analysis. EPA disagrees that such an analytic approach would be a reasonable one, given that ZEV applications are suitable (and in some instances, available now) for these broader market segments. Disallowing them analytically, *i.e.*, *a priori* via a 50th percentile battery sizing assumption, consequently, is not reasonable. We take these commenters' point, however, that some HD vehicles—even tractors—do not need batteries sized as large as in the proposal's approach due to lower daily VMT. We have accordingly revised the sleeper cab and day cab tractors in HD TRUCS to account for a wide variety of operations including short- and long-range tractors. The sales distribution of these vehicles was informed by California's Large Entity Survey, which we also used in the NPRM and includes the percentage of trips by mileage for day cabs and for sleeper cabs.<sup>593</sup>

In the final rule, our modeled compliance pathway includes BEVs that would utilize enroute charging, instead

<sup>593</sup> California Air Resources Board. "Large Entity Reporting." Available at <https://ww2.arb.ca.gov/our-work/programs/advanced-clean-trucks/large-entity-reporting>.

of depending on only charging at their depot. In the applications where enroute charging is utilized, manufacturers would not need to assume the extra battery capacity required to meet the longest VMT days, and therefore will instead match the battery size to the typical operational needs. To determine the appropriate size of the battery for these vehicles, we concluded that the vehicles would not require the same battery sizing approach we used in the NPRM for depot-charged vehicles. Instead, we sized the batteries for enroute-charged BEVs to meet the 50th percentile daily VMT needs. For the longest range day cabs and sleeper cabs, on days when these vehicles are required to travel longer distances, we find that less than 30 minutes of mid-day charging at 1 MW is sufficient to meet the HD TRUCS 90th percentile VMT assuming vehicles start the day with a full battery. Details regarding enroute charging can be found in RIA Chapters 2.2.1.2 and 2.6.3. Please see RIA Chapter 2.2.1.2 Table 2-3 for the complete list of VMT for each of the 101 vehicle types.

We continue to base the majority of our sizing VMT on the same sources we used in the NPRM. We understand that there are many different datasets available and that the 90th percentile VMT will be different in each dataset. However, the NREL FleetDNA and MOVES databases use data from many different sources across the country giving a homogenized representation of the HD fleet nationwide rather than data from a single source, even if that data was collected on a nationwide basis. Thus, after consideration of comments, our assessment is that the sources we use are better suited for the purposes of this final rule and that our use of them is reasonable.

**b. Powertrain-Specific Energy**

HVAC requirements vary by vehicle type, location, and duty cycle. The HVAC energy required to heat and cool interior cabins is considered separately from the baseline energy in HD TRUCS, since these energy loads are not required year-round or in all regions of the country. Nearly all commercial vehicles are equipped with heat and basic ventilation and most vehicles are equipped with air conditioning (A/C). In ICE vehicles, traditional cabin heating uses excess thermal energy produced by the main ICE. This is the only source of cabin heating for many vehicle types. Additionally, on ICE vehicles, cabin A/C uses a mechanical refrigerant compressor that is engine belt-driven.

For BEVs, the energy required for thermal management is different than

for ICE vehicles. First, the loads for HVAC are different because the vehicle is not able to be heated from excess heat from the engine. In this analysis, we considered that HD BEVs may be equipped with either a positive temperature coefficient (PTC) electric resistance heater with traditional A/C, or a full heat pump system, as described in RIA Chapter 1. The vehicle's battery is used to power either system, but heat pumps are many times more efficient than PTC heaters. Given the success and increasing adoption of heat pumps in light-duty EVs, we believe that heat pumps will be the more commonly used technology and thus project the use of heat pumps in our HD TRUCS analysis.

To estimate HVAC energy consumption of BEVs in HD TRUCS, we performed a literature and market review. Even though there are limited real-world studies, we agreed with the

HVAC modeling-based approach described in Basma et. al.<sup>594</sup> This physics-based cabin thermal model considers four vehicle characteristics: the cabin interior, walls, materials, and number of passengers. The authors modeled a Class 8 electric transit bus with an HVAC system consisting of two 20-kW reversible heat pumps, an air circulation system, and a battery thermal management system. We used their estimated HVAC power demand values as a function of temperature, resembling a parabolic curve, where hotter and colder temperatures require more power with the lowest power demand between 59 to 77 °F, as shown in RIA Chapter 2.4.1.1.1.

As explained in the NPRM, the power required for HVAC in HD TRUCS is based on a Basma et. al study that determined the HVAC power demand across a range of ambient

temperatures.<sup>595</sup> However, for the final rule analysis, we made an adjustment to HD TRUCS to reflect a wider range of cooling temperatures (as compared to the proposed greater than 80 °F). In the final rule analysis, we created three separate ambient temperature bins: one for heating (less than 55 °F), one for cooling (greater than 75 °F), and one for a temperature range that requires only ventilation (55–75 °F). In HD TRUCS, we already accounted for the energy loads due to ventilation in the baseline energy demand, so no additional energy consumption is applied here for the ventilation-only operation. We then weighted the power demands by the percent HD VMT traveled at a specific temperature range. The results of the VMT-weighted HVAC power demand for a Class 8 Transit Bus are shown in Table II–11.



Lastly, HVAC load is dependent on cabin size—the larger the size of the cabin, the greater the HVAC demand. The values for HVAC power demand shown in Table II–11 represent the power demand to heat or cool the interior of a Class 8 Transit bus. However, HD vehicles have a range of cabin sizes; therefore, we developed scaling ratios relative to the cabin size of a Class 8 bus. Each vehicle's scaling factor is based on the surface area of the vehicle compared to the surface area of the Class 8 bus. Cabin sizes for most HD vehicle types have a similar cabin to a mid-size light-duty vehicle and therefore, an average scaling factor of 0.2 was applied to all of those vehicle types.<sup>596</sup> The buses and sleeper cab tractors have cabin sizes similar to the transit bus or scaled down to reflect its relative cabin size. For example, a Class 4–5 shuttle bus has a cabin size ratio of 0.6. For additional information see RIA Chapter 2.4.1.1.1. In response to our request for data on HVAC loads for BEVs, we did receive additional modeling data from one commenter that included HVAC loads for European long-haul tractors. We found the new

data to be corroborative with our HVAC loads and the sleeper cab scaling factor; therefore, we did not adjust our HVAC loads from proposal in HD TRUCS.

Fuel cell stacks produce excess heat during the conversion of hydrogen to electricity, similar to an ICE during combustion. This excess heat can be used to heat the interior cabin of the vehicle. In HD TRUCS, we already accounted for the energy loads due to ventilation in the axle loads, so no additional energy consumption is applied to FCEV for heating operation. Therefore, for FCEV energy consumption in HD TRUCS, we only include additional energy requirements for air conditioning (*i.e.*, not for heating).<sup>597</sup> As described in RIA Chapter 2.4.1.1.1, we assigned a power demand of 2.01 kW for powering the air conditioner on a Class 8 bus. The A/C loads are then scaled by the cabin volume for other vehicle applications in HD TRUCS and applied to the VMT fraction that requires cooling, just as we did for BEVs.

BEVs have thermal management systems to maintain battery core temperatures within an optimal range of

approximately 68 to 95 degrees Fahrenheit (F).<sup>598</sup> In HD TRUCS, we accounted for the battery thermal management energy demands as a function of ambient temperature based on a Basma et. al study.<sup>599</sup> As described in RIA Chapter 2.4.1.1.3, we determined the amount of energy consumed to heat the battery with cabin air when it is cold outside (less than 55 °F) and energy consumed to cool the battery when it is hot outside (greater than 75 °F) with refrigerant cooling. Note, as similarly described in the HVAC discussion in this subsection and as discussed in RIA Chapter 2.4.1.1, we extended the temperature range for cooling from greater than 80 °F to greater than 75 °F for the final rule. For the ambient temperatures between these two regimes, we agreed with Basma, et. al that only ambient air cooling is required for the batteries, which requires no additional load. We first determined a single VMT-weighted power consumption value for battery heating and a value for battery cooling based on the MOVES HD VMT distribution and based on the same method used for HVAC. Then, we determined the energy

<sup>594</sup> Basma, Hussein, Charbel Mansour, Marc Haddad, Maroun Nemer, Pascal Stabat. "Comprehensive energy modeling methodology for battery electric buses". Energy: Volume 207, 15 September 2020, 118241. Available online: <https://www.sciencedirect.com/science/article/pii/S0360544220313487>.

<sup>595</sup> It should be noted that Basma model has discrete values in Celsius and MOVES data has discrete values in Fahrenheit. The Basma discrete values in the Basma model is fitted to a parabolic

curve and converted into Fahrenheit to best fit the VMT distribution that is available in MOVES.

<sup>596</sup> The interior cabin where the driver and passengers sit are heated while where the cargo is stored is not heated.

<sup>597</sup> FCEVs use waste heat from the fuel cell for heating, and that ventilation operates the same as it does for an ICE vehicle.

<sup>598</sup> Basma, Hussein, Charbel Mansour, Marc Haddad, Maroun Nemer, Pascal Stabat. "Comprehensive energy modeling methodology for

battery electric buses". Energy: Volume 207, 15 September 2020, 118241. Available online: <https://www.sciencedirect.com/science/article/pii/S0360544220313487>.

<sup>599</sup> Basma, Hussein, Charbel Mansour, Marc Haddad, Maroun Nemer, Pascal Stabat. "Comprehensive energy modeling methodology for battery electric buses". Energy: Volume 207, 15 September 2020, 118241. Available online: <https://www.sciencedirect.com/science/article/pii/S0360544220313487>.

required for battery conditioning required for eight hours of daily operation and expressed it in terms of percent of total battery size. Table II-12 shows the energy consumption for

battery conditioning for both hot and cold ambient temperatures, expressed as a percentage of battery capacity, used in HD TRUCS. The battery cooling energy consumption percentage reflects an

updated value for the final rule that includes the battery cooling loads down to 75 °F.

**Table II-12 Battery Conditioning Energy Consumption**

	Ambient Temperature (°F)	Energy Consumption (%)
Battery Heating	<55	1.9%
Battery Cooling	>75	3.0%

iii. BEV Component Sizing and Weight

We used HD TRUCS to determine the size of two of the major components in a BEV: the battery and the motor. The size of these components is determined by the energy needs of the specific vehicle to meet its daily operating requirements. In this subsection, we also discuss our method to evaluate the payload and packaging impact of the battery.

a. Battery

First, in HD TRUCS, we based the size of the battery on the daily demands on the vehicle to perform a day’s work, as explained in section II.D.5.ii.a. As described in the Vehicle Energy Demand subsection, section II.D.5.ii, this daily energy consumption is a function of miles the vehicle is driven and the energy it consumes because of: (1) moving the vehicle per unit mile, including the impact of regenerative braking and PTO energy requirements, and (2) battery conditioning and HVAC energy requirements. Then we also accounted for the battery efficiency, depth of discharge, and deterioration in sizing of the batteries for BEVs.

The daily energy consumption of each BEV in HD TRUCS is determined by applying efficiency losses to energy consumption at the axle. These losses for the inverter, gearbox, and e-motor are calculated using loss maps of each component of production components for a Class 5 and a Class 8 vehicle, as described in RIA Chapter 2.4.1.1. Next, we oversized the battery to account separately for the typical usable amount of battery and, if necessary, for battery deterioration over time. For the NPRM, we sized the battery by limiting it to a maximum depth of discharge of 80 percent, recognizing that manufacturers and users likely would not allow the battery capacity to be depleted beyond 80 percent of original capacity. We also accounted for deterioration of the battery capacity over time by oversizing the battery by 20 percent, assuming only 80 percent of the battery storage is available throughout its life. We requested comment and data on heavy-

duty battery depth of discharge and deterioration. 88 FR 25977.

We received numerous comments about limiting depth of discharge to 80 percent as well as 20 percent extra battery capacity to account for battery deterioration over time. Some of these commenters said we should reduce or remove the additional 20 percent of extra battery capacity for degradation and the 80 percent depth of discharge. Others pointed out that batteries degrade over time and will reduce in capacity, up to 3 percent annual capacity loss.

One commenter cited a February 2022 Roush report on the electrification of tractors where Roush had set the depth of discharge to 90 percent and a 10 percent battery degradation value and suggested using those values. They also pointed out that the decrease in VMT over time used in the proposal’s version of HD TRUCS for calculating operating costs meets or exceeds the 20 percent reduction in battery capacity over that same time. They argued that the decrease in VMT already accounts for 20 percent battery deterioration and that it should not be included, or that EPA should adopt the 10 percent value that Roush used in their report. Another commenter questioned the source for a 20 percent battery capacity fade. They agreed that batteries will degrade over time but stated that data is scarce for HD applications and that recent developments in battery technology have resulted in prolonged battery life with long-distance BEVs reaching over 900,000 miles. Another commenter stated that the additional 20 percent battery sizing for deterioration was an overly conservative estimate and that fleets would adjust the mileage and routes used for a vehicle over time as they currently do with ICE vehicles from the secondary market. They stated that fleets would not pay for the additional unused battery capacity. This commenter also raised concerns about using an 80 percent depth of discharge value, saying that it would be more appropriate to model battery usage and mileage based on capacity fade and

citing a demonstration by Yang et al. and Dunn et al. Another commenter stated that oversizing the battery biases downward the projected rate of BEV adoption due to increased costs attributable to the extra battery capacity. Relatedly, a few commenters raised concerns about the cost of replacing a vehicle battery. They stated that is a very large cost that should be accounted for.

After considering these comments, and further supported by the state of charge window value used in the 2022 Autonomie tool from Argonne National Laboratory, we revised the battery depth of discharge window to 90 percent in HD TRUCS.<sup>600</sup> This is further discussed in RIA Chapter 2.4.1.1.

EPA also re-evaluated the blanket application of 20 percent deterioration value used for all vehicles in the proposal based on consideration of comments received. We agreed with certain commenters regarding existing data supports that HD VMT decreases as vehicles get older, and thus an older HD BEV would not need to have as much range as it needed when it was new to be comparable to a comparable ICE vehicle. Consequently, in the final rule, we determined the battery deterioration factor for each of the 101 vehicle applications based on the number of charging cycles the battery would require during its first ten years of operation. See RIA Chapter 2.4.1.1.3.

In the final rule, we are considering the costs of battery replacement and ICE rebuilds in our analysis of the costs to purchasers, as discussed in section IV. We are not considering battery replacement cost in our 10-year ownership calculation costs in HD TRUCS. Similarly, we do not consider engine rebuilding costs for ICE vehicles in our parallel 10-year ownership calculation of costs. The reason is the same in both instances: we do not

<sup>600</sup> Argonne National Laboratory. VTO HFTO Analysis Reports—2022. “ANL—ESD—2206 Report—MD HD Truck—Autonomie Assumptions.xlsx”. Available online: <https://anl.app.box.com/s/an4nx0v2xpxdxtpsnkhd5peimzu4j1hk/folder/242640145714>.

expect failure of either the battery pack or the engine during the vehicles' first ten years of ownership, which is the period we focused on in our HD TRUCS analysis.

We have made certain conforming adjustments within HD TRUCS reflecting these considerations. In the final rule, instead of applying a constant deterioration factor, we determined the battery deterioration factor for each of the 101 vehicle applications based on the number of charging cycles the battery would require during its first ten years of operation. The ten years represents the longest payback period we consider for the technologies in our technology package. A cycle is defined as a single full charge and discharge cycle. The number of cycles is determined based on the annual operating VMT of the vehicle over the 10-year timeframe.

We selected 2,000 cycles as our number of cycles target at 10 years of age while recognizing this value depends on a number of internal and external parameters including battery chemistry, the discharge window while cycling, power output of the battery, and how the battery is managed while in and not in use. A study shows LFP batteries can maintain 80 to 95 percent state of charge after 3,000 cycles and nickel-based lithium-ion batteries are

shown to retain 80 percent state of charge after 2,000 cycles under some test conditions.<sup>601</sup> Our use of a 2,000-cycle limitation is consequently conservative. We increased the battery size as necessary for vehicles such that the battery would not exceed 2,000 cycles at the end of the 10-year period—the number of cycles reflecting 10-year VMT, as just noted. We note that only eight vehicles in HD TRUCS require a 15 percent increase in battery size and meet the 2,000 cycle limit over a ten year period. Most of the 101 vehicle types would experience less than 1,500 cycles over the ten-year period. The battery sizing is described in greater detail in RIA Chapters 2.4.1.1 and 2.8.5.3.

b. Motor

We determined the size of the motor for each vocational and day cab tractor BEV based on the maximum power demand of the transient cycle and highway cruise cycles, the vehicle's ability to meet minimum performance targets in terms of acceleration rate of the vehicle, and the ability of the vehicle to maintain speed going up a hill. For sleeper cabs, the motor size was determined to be 400 KW based on the comparable ICE sleeper cab tractor engine power and the continuous motor power of existing HD BEV tractors.<sup>602</sup>

For heavy haul tractors, the BEV motor power is set at 450 kW to reflect the maximum engine power of heavy heavy-duty engines.<sup>603</sup> As described in RIA Chapter 2.4.1.2, we estimated a BEV motor's peak power needs to size the e-motor, after considering the peak power required during the ARB transient cycle<sup>604</sup> and performance targets included in ANL's Autonomie model<sup>605</sup> and in Islam et al.,<sup>606</sup> as indicated in Table II-13. We assigned the target maximum time to accelerate a vehicle from stop to 30 mph and 60 mph based on weight class of each vehicle. We also used the criteria that the vehicle must be able to maintain a specified cruise speed while traveling up a road with a 6 percent grade, as shown in Table II-13. In the case of cruising at 6 percent grade, the road load calculation is set at a constant speed for each weight class bin on a hill with a 6 percent incline. We determined the required power rating of the motor as the greatest power required to drive the vehicle over the ARB transient test cycle, at 55 mph and 65 mph constant cruise speeds, or at constant speed at 6 percent grade, and then applied losses from the e-motor. We requested comment on our approach using these performance targets in the NPRM but did not receive any comments on this issue.

**Table II-13 ANL Performance Targets**

Weight Class Bin	Vocational				Tractors	
	2b-3	4-5	6-7	8	7	8
0-30 mph Time (s)	7	8	16	20	18	20
0-60 mph Time (s)	25	25	50	100	60	100
Cruise Speed (mph) @ 6 % grade	65	55	45	25	35	25

c. Battery Weight and Volume

Performance needs of a BEV could result in a battery that is so large or heavy that it impacts payload and, thus, potential work accomplished relative to a comparable ICE vehicle. We determined the battery weight and physical volume for each vehicle

application in HD TRUCS using the specific energy and energy density of the battery for each battery capacity.

As described in RIA Chapter 2.4.2, to determine the weight impact, we used battery specific energy, which measures battery energy per unit of mass. In the NPRM, we used specific energy values

for the battery pack that ranged between 199 Wh/kg in MY 2027 and 233 Wh/kg in MY 2032. 88 FR 25978. We received comments from two commenters on improvements in battery specific energy higher than the values used in the proposal. EPA recognizes there have been significant development in the

<sup>601</sup> Preger, Yuliya, et. al. "Degradation of Commercial Lithium-Ion Cells as a Function of Chemistry and Cycling Conditions." Journal of the Electrochemical Society. September 2020. Available at: <https://iopscience.iop.org/article/10.1149/1945-7111/abae37>.

<sup>602</sup> Peterbilt. 579EV. Available online: <https://www.peterbilt.com/trucks/electric/579EV>.

<sup>603</sup> Detroit Diesel Engines. Available online: <https://www.demanddetroit.com/engines/dd16/>.

<sup>604</sup> EPA uses three representative duty cycles for calculating CO<sub>2</sub> emissions in GEM: a transient cycle and two highway cruise cycles. The transient duty

cycle was developed by the California Air Resources Board (CARB) and includes no grade—just stops and starts. The highway cruise duty cycles represent 55-mph and 65-mph vehicle speeds on a representative highway. They use the same road load profile but at different vehicle speeds, along with a percent grade ranging from -5 percent to 5 percent.

<sup>605</sup> Islam, Ehsan Sabri, Ram Vijayagopal, Ayman Moawad, Namdoo Kim, Benjamin Dupont, Daniela Nieto Prada, Aymeric Rousseau, "A Detailed Vehicle Modeling & Simulation Study Quantifying Energy Consumption and Cost Reduction of

Advanced Vehicle Technologies Through 2050," Report to the U.S. Department of Energy, Contract ANL/ESD-21/10, October 2021. See previous reports and analysis: 2021. Available online: <https://vms.taps.anl.gov/research-highlights/u-s-doe-vto-hfto-r-d-benefits/>.

<sup>606</sup> Islam, Ehsan Sabri, Ram Vijayagopal, Aymeric Rousseau. "A Comprehensive Simulation Study to Evaluate Future Vehicle Energy and Cost Reduction Potential", Report to the U.S. Department of Energy, Contract ANL/ESD-22/6, October 2022. Available online: <https://vms.taps.anl.gov/research-highlights/u-s-doe-vto-hfto-r-d-benefits/>.

areas of battery chemistry, battery cell and battery pack design. These commenters provided examples and values for battery specific energy as well as energy density. However, as explained in RIA Chapter 2.4.2, there is a difference between battery cell properties and battery pack properties.<sup>607</sup> For a complete discussion of information provided by commenters on battery specific energy, see RTC section 3.2.3.

For HD TRUCS, one metric for feasibility is to determine the weight of the BEV powertrain system which includes the battery pack weight as well as the motor weight (and gear box when required). Since battery packs consist of a group of cells (or modules), additional mass from packaging, cooling system and battery management system (BMS) add additional mass without providing additional energy. For the final rule, instead of solely relying on the 2021 version of Autonomie as we did at proposal, we also analyzed the battery specific energy values provided in the comments received on the proposal, ANL BEAN values, values from DOE as provided by a 2024 ANL study,<sup>608</sup> and values in the FEV study.<sup>609</sup> For our weight assessment in the final rule, we utilized the battery pack specific energy values from the 2024 ANL study because it contains the most comprehensive and most recent assessment of the battery industry. As with battery cost, we used a 50/50 mix

<sup>607</sup> Energy within the battery is stored in the battery cell, or more specifically in the active anode and the active cathode, or more simply referred to as the active materials (for example nickel manganese cobalt). The specific energy is a measure of how much energy can be stored per unit weight. For a given amount (weight) of active materials, it has the ability to store some amount of energy. However, active material weight within the battery is very low; instead most of the battery cell weight is comprised of housing. Since batteries typically do not exist as just active material, the specific energy is reported in terms of amount of energy (in Wh) stored in the active material and the weight of all the components that go into the battery cell. Furthermore, for transportation batteries, a battery pack consists of many (hundreds or thousands) cells, the weight of the battery is further increased from the additional mass that is added to make the pack level structure. This therefore lowers the specific energy of the battery pack (Wh remains constant since the energy is stored in the active materials and weight increases from more mass added from the pack). There is frequent reporting that conflates cell level specific energy with pack level specific energy, or the values are unspecified.

<sup>608</sup> Kevin Knehr, Joseph Kubal, Shabbir Ahmed, "Cost Analysis and Projections for U.S.-Manufactured Automotive Lithium-ion Batteries", Argonne National Laboratory report ANL/CSE-24/1 for US Department of Energy, January 2024. Available online: <https://www.osti.gov/biblio/2280913>.

<sup>609</sup> FEV Consulting, "Heavy Duty Commercial Vehicles Class 4 to 8: Technology and Cost Evaluation for Electrified Powertrains—Final Report". Prepared for EPA, March 2024.

of NiMn and LFP batteries to determine the average specific energy for batteries. The NiMn batteries have a specific energy of 226 Wh/kg and LFP at 170 Wh/kg, the resulting value, used in our analysis, is 198 Wh/kg. For further details on battery specific energy see RIA Chapter 2.4.2.1.

We recognize that although there likely will be improvements made between 2027 and 2032, it is difficult to determine if the degree of improvements during that time frame, especially considering that manufacturers will have to balance the cost of additional weight reduction and overall costs of the BEV. Therefore, for the final rule we reasonably, and conservatively, held the battery specific energy constant for MYs 2027 through 2032.

To evaluate battery volume and determine the packaging space required for each HD vehicle type, we used battery energy density. Battery energy density (also referred to as volumetric energy density) measures battery energy per unit of volume. To calculate battery energy density, we multiplied the battery specific energy by a factor. For the NPRM, we used pack level energy densities that ranged from 496 Wh/L in MY 2027 to 557 Wh/L in MY 2032. These values corresponded to multiplying the battery pack specific energy by 2.5. We requested comment and data in the NPRM to inform these values for the final rule. 88 FR 25978.

In response to our request for data in the NPRM, one commenter provided data from a study that included battery properties of specific energy and energy density. For more details on the comment and our response, see RTC section 3.2.3. The average energy density calculated from the data provided was 2.2. For the final rule, we used a ratio of 2.0 as a conservative estimate because the properties cited by the initial commenter discussed on a cell level, not a pack level. Based on our update to battery pack specific energy, we used an energy density value of 396 Wh/L for MYs 2027 through 2032 in HD TRUCS.

Heavy-duty vehicles are used to perform work, such as moving cargo or carrying passengers. Consequently, heavy-duty vehicles are sensitive to increases in vehicle weight and carrying volume. To take this into account, we also evaluated BEVs in terms of the overall impact on payload-carrying ability and battery packaging space. The results of this analysis can be found in RIA Chapters 2.4.2 and 2.9.

At proposal, EPA included a 30 percent reduction in the payload used to evaluate compliance in GEM as a metric to determine specific vehicle

applications. Specifically, EPA did not include BEVs in a projected technology package if this payload capacity was reduced by over 30 percent. 88 FR 25978. We note that the payload used to demonstrate compliance in GEM is less than the full payload capability of the vehicle. For vehicles like dump trucks and tractors, that are seen as fully loaded during delivery and empty upon return, the maximum payload was much greater than the GEM payload.

Therefore, the 30 percent threshold used in the NPRM analysis did not represent a 30 percent loss in total payload and its impact on total payload is less than 30 percent. For the proposal, EPA also evaluated payload volume by calculating the width of the physical battery using the volume, wheelbase, and 110 percent of the frame rail height. If the battery width was less than 8.5 feet, we determined the battery would package on the specific vehicle.

Many commenters raised concerns about the reduction in payload due to increased curb weight of ZEVs. The principal concern raised is that battery size and weight constrain payload so much as to render BEVs uneconomic. With respect to our analysis of battery width, commenters asserted that EPA had failed to consider a number of consequential things, including space for tires and the width of each frame rail. There were also several comments on the specific value of payload loss of 30 percent used in HD TRUCS for the NPRM. Three commenters believed the payload penalty limit for BEVs is too high; for some, even a 5 to 10 percent loss is too much to perform their mission. One of these commenters claimed that approximately 20 percent of intermodal loads already max out due to weight under the current diesel truck equipment configuration. Neither of the other two commenters provided any additional information on any acceptable payload capacity loss. One commenter recommended adjustment to the payload cut off, particularly for vocational vehicles such as concrete mixers, dump trucks, and tanker trucks.

At proposal, EPA justified the cargo penalty metric based on a report of the North American Council for Freight Efficiency (NACFE) which the agency characterized as stating that vehicles weigh out before cubing out.<sup>610</sup> DRIA p. 234. Two commenters stated that EPA misunderstood the NACFE report. One commenter maintained that the NACFE report references a "per run" load instead of a "per truck" vehicle load. As

<sup>610</sup> EPA "Draft Regulatory Impact Analysis: Heavy-Duty Greenhouse Gas Emissions: Phase 3." April 2023. Page 234.



load of the truck is unpredictable, any additional reduction in payload capacity reduces the flexibility and use of the vehicle. Another commenter not only concurred but also stated that the NACFE report only refers to regional trucks which makes it inappropriate to apply to all 101 vehicles in HD TRUCS. Lastly, one commenter asserted that since the NACFE report is from 2010 and the industry has gone through significant changes since then as a result of e-commerce as well as shipping practices, the assumed 30 percent weight penalty used at proposal should be included in the cost of the vehicle as fleets would account for the additional cost of making up for the lost payload through additional trips or vehicles.

After considering these comments, we are not using a 30 percent payload reduction as a metric for determining BEV suitability and are no longer estimating battery width based on frame rail height and wheelbase. Instead, for the final rule we conducted a more robust analysis where we assessed each vehicle in HD TRUCS on an individual basis and determine the suitability of each application, as described in this section and in RIA 2.9.1. EPA conducted two separate individualized types of determinations: one for battery payload weight, the other for battery volume. See RIA Chapter 2.9.1.1 and 2.9.1.2. We note further that this delineation responds to those comments relating to weighing out and cubing out, since we are conducting separate analyses for each of these situations. Furthermore, after consideration of comments, we are no longer using the NACFE report in this analysis to inform a single weight penalty cutoff for all types of vehicles.

With respect to weight, we compared the respective weights of the BEV powertrain with the comparable ICE powertrain. We determined the percentage difference in weight using the maximum payload available to each vehicle type, not the default GEM payload. For example, for the Class 8 dump trucks, the payload difference (loss) was modest: 2.6 percent; with the NiMn battery chemistry specific energy (226 Wh/kg)<sup>611</sup> the payload loss is 1.3 percent. The tanker payload loss was 2 percent of maximum payload. EPA does not view these differences as sufficient

to preclude utilization of BEV technology at the rates projected in EPA's modeled compliance pathway. See RIA Chapter 2.9.1.1 for detailed weight comparisons by vehicle, and more detailed discussion of specific applications. On the other hand, for concrete mixers and pumpers, EPA determined that battery size, energy demand, and corresponding costs were all significantly higher than EPA had projected at proposal and accordingly determined that EPA's optional custom chassis standards for Concrete Mixers/Pumpers and Mixed-Use Vehicles will remain unchanged from the Phase 2 MY 2027+ CO<sub>2</sub> emission standards.<sup>612</sup>

For tractors, EPA did the same type of weight comparison, and found the weight increase to be reasonable for most of the tractors in HD TRUCS. See RIA 2.9.1.1 for vehicle by vehicle difference in weight and a more detail discussion of specific applications. EPA further examined when tractors are utilized at maximum load<sup>613</sup> and found that many commodities do not require transport at maximum load, for further discussion on our analysis of tractor loading based on commodities, see Chapter 2.9.1 of the RIA. Our ultimate conclusion is that our modeled compliance pathway projects a majority of these vehicles remain ICE vehicles, that ICE vehicles therefore would be available to accommodate those commodities for which maximum loads are needed, and that BEVs remain viable for those other commodities that do not require transport at maximum load.

Our analysis respecting volume is somewhat different. We make the reasonable assumption that if a current BEV (either tractor or vocational vehicle) exists, its volumetric capacity is suitable. Thus, if the HD TRUCS version of that BEV has the same or similar battery size as an existing BEV, we did not constrain the adoption of that BEV type due to volume loss. In some instances, we examined further whether wheelbase adjustments could accommodate larger battery sizes so as not to constrain available volume. See RIA 2.9.1.2 for a vehicle-by-vehicle discussion and more detail on specific vehicle applications.

In assessing the packaging of a FCEV powertrain, we contracted with FEV to

assess how FCEVs can store and package hydrogen. The FEV study shows that six tanks could fit on a sleeper cab tractor with a wheelbase of 265".<sup>614</sup> A vehicle class where we determined that battery size, or fuel cell and hydrogen tank size, would reduce storage volume for some applications was coach buses, and therefore we did not finalize more stringent optional custom chassis standards for coach buses, as discussed in section II.F.1.<sup>615</sup> Our individualized determinations for all of these vehicles are found in RIA 2.9.1.2.

#### iv. Charging Infrastructure for BEVs

Charging infrastructure represents a key element required for HD BEV operation. More charging infrastructure will be needed to support the projected growing fleet of HD BEVs. This will likely consist of a combination of (1) depot charging—with infrastructure installed in parking depots, warehouses, and other private locations where vehicles are parked off-shift (when not in use), and (2) public charging,<sup>616</sup> which provides additional electricity for vehicles during their operating hours.

In RIA Chapters 2.6 and 2.8.7 we describe how we accounted for charging infrastructure in our analysis of HD BEV technologies for our technology packages to support the feasibility of the standards and extent of use of HD BEV technologies in the potential compliance pathway for MYs 2027–2032. We explain there in detail the updates made after consideration of comments and newly available supporting data from NREL. For the NPRM analysis, we estimated infrastructure costs exclusively associated with depot charging to fulfill each BEV's daily charging needs off-shift with the appropriately sized electrical vehicle supply equipment. This approach reflected our expectation that many heavy-duty BEV owners would opt to purchase and install EVSE at depots, and accordingly, we accounted for all of these costs upfront. We received many comments on this approach. While multiple commenters agreed that depot charging would be the primary source of charging across many vehicle applications, especially in the early years of the Phase 3 program, some

<sup>611</sup> Battery chemistry impacts the battery pack specific energy and battery technology continues to evolve suggesting that battery pack weight may decrease and payload increase. To assess the sensitivity of payload to higher specific energy, EPA reviewed two additional scenarios (1) use of NiMn batteries (HD TRUCS uses a value that represents a 50/50 mix of NiMn and LFP to align with battery cost assumptions) and (2) possible NiMn battery pack specific energy improvements through 2030.

<sup>612</sup> See also section II.F.1 discussing optional custom chassis standards, including those for concrete mixers.

<sup>613</sup> DOE. Vehicle Technologies Office. Fact of the Week #1293. "In 2019, More Heavy Trucks Operated at 34,000 to 36,000 Pounds than Any Other Weight Category". Available online: <https://www.energy.gov/eere/vehicles/articles/fotw-1293-june-5-2023-2019-more-heavy-trucks-operated-34000-36000-pounds-any>.

<sup>614</sup> FEV Consulting. "Heavy Duty Commercial Vehicles Class 4 to 8: Technology and Cost Evaluation for Electrified Powertrains—Final Report". Prepared for EPA. March 2024.

<sup>615</sup> See also II.F.1 discussing optional custom chassis standards, including those for coach buses.

<sup>616</sup> En-route charging could occur at public or private charging stations though, for simplicity, we often refer to en-route charging as occurring at public stations in the preamble.

commenters noted the importance of also accounting for public charging in our analysis. Commenters asserted that long-haul vehicles and other fleet vehicles that either do not regularly return to a depot, or for which installing depot charging would be difficult, may utilize public charging including during the initial model years (through 2032) covered by the Phase 3 program.

For our final rule analysis, after consideration of these comments, we have updated our HD TRUCS model to incorporate costs associated with public charging for certain vehicle types starting with MY 2030, the year when we project there will be sufficient public charging infrastructure for HD vehicles for the projected utilization of such technologies. See RIA Chapter 1.6. Specifically, in HD TRUCS we assume that all BEV sleeper cab tractors and coach buses will use public charging rather than depot charging, as will four of the ten day cab tractors—those with longer ranges—that we model. In HD TRUCS we assume public charging needs will be met with a mix of megawatt-level EVSE and 150 kW EVSE, consistent with a recent ICCT analysis.<sup>617</sup> In our analysis for the final rule, capital costs associated with public charging equipment are passed through to BEV owners through a higher charging cost. See RIA Chapter 2.4.4.2.

For other day cab tractors and vocational vehicles, in HD TRUCS we continue to assume that daily charging needs can be met with appropriately sized depot EVSE. A range of depot charging equipment is available including AC or DC charging, different power levels, as well as options for different number of ports and connectors per charging unit, connector type(s), communications protocols, and additional features such as vehicle-to-grid capability (which allows the vehicle to supply energy back to the grid). Many of these selections will impact EVSE hardware and installation costs, with power level as one of the most significant drivers of cost. While specific cost estimates vary across the literature, higher-power charging equipment is typically more expensive than lower-power units. For this reason, in HD TRUCS for the final rule we continued our proposed approach to consider four different charging types—AC Level 2 (19.2 kW) and 50 kW, 150 kW, and 350 kW DC fast charging

(DCFC)—though we have made updates to cost assumptions and other key inputs that impact our depot charging analysis, as described in section II.E.2 of this document.

We acknowledge that even vehicles which predominantly rely on depot charging may utilize some public charging, for example on high travel days. In addition, some fleet owners may opt not to install depot charging, and instead either rely on public charging or make alternative arrangements such as using charging-as-a-service or other business arrangements to meet charging needs. See RIA Chapter 2.6 for a more complete description of this topic.

#### v. FCEV Component Sizing

To compare HD FCEV technology costs and performance to a comparable ICE vehicle in HD TRUCS, this section explains how we define HD FCEVs based on the performance and use criteria in RIA Chapter 2.2 (that we also used for HD BEVs, as explained in section II.D.5.ii). We determined the e-motor, fuel cell system, and battery pack sizes to meet the power requirements for each of the FCEVs represented in HD TRUCS. We also estimated the size of the onboard fuel tank needed to store the energy, in the form of gaseous hydrogen, required to meet typical range and duty cycle needs. See RIA Chapter 2.5 for further details.

#### a. E-Motor

As discussed in RIA Chapter 2.4.1.2, the e-motor is part of the electric drive system that converts the electric power from the battery and/or fuel cell into mechanical power to move the wheels of the vehicle. In HD TRUCS, the e-motor was sized for a FCEV like it was sized for a BEV—to meet peak power needs of a vehicle, which is the maximum power to drive the ARB transient cycle, meet the maximum time to accelerate from 0 to 30 mph, meet the maximum time to accelerate from 0 to 60 mph, and maintain a set speed up a six-percent grade.

#### b. Fuel Cell System

Vehicle power in a FCEV comes from a combination of the fuel cell (FC) stack and the battery pack. The fuel cell behaves like the internal combustion engine of a hybrid vehicle, converting chemical energy stored in the hydrogen fuel into electrical energy. The battery is charged by power derived from regenerative braking, as well as excess power from the fuel cell. Some HD FCEVs are designed to rely on the fuel cell stack to produce the necessary power, with the battery primarily used

to capture energy from regenerative braking. This is the type of HD FCEV that we modeled in HD TRUCS for the MY 2030 to 2032 timeframe in order to meet the longer distance requirements of select vehicle applications.<sup>618 619 620</sup>

While much of FCEV design is dependent on the use case of the vehicle, manufacturers also balance the cost of components such as the fuel cell, the battery, and the hydrogen fuel storage tanks. For the purposes of this HD TRUCS analysis, we focused on PEM fuel cells that use energy battery cells, where the fuel cell and the battery were sized based on the demands of the vehicle. In HD TRUCS, the fuel cell system (*i.e.*, the fuel cell stacks plus balance of plant, or BOP) was sized at either the 90th percentile of power required for driving the ARB transient cycle or to maintain a constant highway speed of 75 mph with 80,000-pound gross combined vehicle weight (GCVW). The 90th percentile power requirement was used to size the fuel cells of vocational vehicles and day cab tractors, and the 75-mph power requirement was used to size the fuel cells of sleeper cab tractors.<sup>621</sup>

We received comments suggesting that the NPRM did not accurately reflect how a fuel cell operates because we relied on peak fuel cell efficiency rather than average operating efficiency. One commenter noted that FCEVs would benefit from BEV component efficiency gains and observed that we did not

<sup>618</sup> Islam, Ehsan Sabri, Ram Vijayagopal, Aymeric Rousseau. “A Comprehensive Simulation Study to Evaluate Future Vehicle Energy and Cost Reduction Potential”, *Report to the U.S. Department of Energy, Contract ANL/ESD-22.6*. October 2022. See Full report. Available online: <https://anl.app.box.com/s/an4nx0v2xpudxtpsnkh5p5eimzu4j1hk/file/1406494585829>.

<sup>619</sup> Note that ANL’s analysis defines a fuel cell hybrid EV (FCHEV) as a battery-dominant vehicle with a large energy battery pack and a small fuel cell, and a fuel cell EV (FCEV) as a fuel cell-dominant vehicle with a large fuel cell and a smaller power battery. Ours is a slightly different approach because we consider a fuel cell-dominant vehicle with a battery with energy cells. The approach we took is intended to cover a wide range of vehicle application however it results in a conservative design, as it relies on a large fuel cell and a larger energy battery. As manufacturers design FCEV for specific HD applications, they will likely end up with a more optimized lower cost designs. Battery-dominant FCHEVs and fuel cell-dominant technologies with power batteries may also be feasible in this timeframe but were not evaluated for the FRM.

<sup>620</sup> FEV Consulting. “Heavy Duty Commercial Vehicles Class 4 to 8: Technology and Cost Evaluation for Electrified Powertrains—Final Report”. Prepared for EPA. March 2024.

<sup>621</sup> In the NPRM version of HD TRUCS, we inadvertently used the 90th percentile of the ARB transient cycle to size the sleeper and day cab tractors and the power required to drive at 75 mph to size the vocational vehicles. This error is corrected in the final version of HD TRUCS.

<sup>617</sup> Hussein Basma, Claire Buysee, Yuanrong Zhou, and Felipe Rodriguez, “Total Cost of Ownership of Alternative Powertrain Technologies for Class 8 Long-haul Trucks in the United States,” April 2023. Available at: <https://theicct.org/wp-content/uploads/2023/04/tco-alt-powertrain-long-haul-trucks-us-apr23.pdf>.

utilize the DOE targets for peak fuel cell efficiency in HD TRUCS, implying that fuel cells could be more efficient than we assumed in the NPRM because a more efficient stack would require less cooling, which could lead to compounded gains over time. Three commenters suggested that the fuel cell efficiency values used in the NPRM were too high. One commenter pointed out that we considered peak efficiency estimates rather than average operating efficiencies. The same commenter and another offered ranges for operating efficiency at power levels typical for commercial vehicles and suggested that we revise our fuel cell efficiency estimates. One of the same commenters noted that fuel cell performance degrades over time, generally due to impurities in hydrogen fuel that cause efficiencies to drop significantly from beginning of life to end of life. We evaluated these comments and find them persuasive. Accordingly, we have revised our sizing methodology for the fuel cell system (to meet power demands of a vehicle) and onboard hydrogen storage tanks (to meet energy demands of a vehicle, as described in section II.D.5.d) in the final rule version of HD TRUCS.

RIA Chapter 2.5.1.1.2 explains that to avoid undersizing the fuel cell system, we oversized the fuel cell stack by an additional 25 percent to allow for occasional scenarios where the vehicle requires more power (e.g., to accelerate when the battery state of charge is low, to meet unusually long grade requirements, or to meet other infrequent extended high loads like a strong headwind) and so the fuel cell can operate within an efficient region. This size increase we included in the final rule version of HD TRUCS can also improve fuel cell stack durability and ensure the fuel cell stack can meet the power needs throughout the useful life. This is the systems' net peak power, or the amount available to power the wheels.<sup>622</sup> The fuel cell stack generates power, but some power is consumed to operate the fuel cell system before it gets to the e-motor. Therefore, we increased the size of the system by an additional 20 percent<sup>623</sup> to account for operation of balance of plant (BOP) components that ensure that gases entering the

system are at the appropriate temperature, pressure, and humidity and remove heat generated by the stack. This is the fuel cell stack gross power.

The larger fuel cell can allow the system to operate more efficiently based on its daily needs, which results in less wasted energy and lower fuel consumption. This additional size also adds durability, which is important for commercial vehicles, by allowing for some degradation over time. We determined that with this upsizing, there is no need for a fuel cell system replacement within the 10-year period at issue in the HD TRUCS analysis.

#### c. Battery Pack

As described in RIA Chapter 2.5.1.1.3, in HD TRUCS, the battery power accounts for the difference between the peak power of the e-motor and the continuous power output of the fuel cell system. We sized the battery to meet these power needs in excess of the fuel cell's capability only when the fuel cell cannot provide sufficient power. In our analysis, the remaining power needs are sustained for a duration of 10 minutes (e.g., to assist with a climb up a steep hill).

Since a FCEV operates like a hybrid vehicle, where power comes from a combination of the fuel cell stack and the battery, the battery is sized smaller than a battery in a BEV, which can result in more cycling of the FCEV battery. Thus, we reduced the FCEV battery's depth of discharge from 80 percent in the NPRM to 60 percent in the final rule version of HD TRUCS to reflect the usage of a hybrid battery more accurately. This means the battery is oversized in HD TRUCS to account for potential battery degradation over time.

#### d. Onboard Hydrogen Storage Tank

A FCEV is re-fueled like a gasoline or diesel-fueled ICE vehicle. We determined the capacity of the onboard hydrogen energy storage system using an approach like the BEV methodology for battery pack sizing in RIA Chapter 2.4.1.1, but we based the amount of hydrogen needed on the daily energy consumption needs of a FCEV.

Hydrogen fuel in the tank enters the fuel cell stack, where an electrochemical reaction converts hydrogen to electricity. During the conversion process, some energy from the hydrogen fuel is lost as heat or otherwise does not go towards producing electricity. The remaining energy is used to operate the fuel cell system. Based on consideration of comments, we agree the fuel cell system efficiency values used in the NPRM were too high and should not be

based on peak performance at low power, since fuel cells typically do not operate for long in that range. We therefore reduced them by eight percent to reflect an average operating efficiency instead of peak efficiency (see RIA Chapter 2.5.1.2.1). This was based on a review of DOE's 2019 Class 8 Fuel Cell Targets. DOE has an ultimate target for peak efficiency of 72 percent, which corresponds to an ultimate fuel cell drive cycle efficiency of 66 percent. This equates to an 8 percent difference between peak efficiency and drive cycle efficiency at a more typical operating power. Therefore, to reflect system efficiency more accurately at a typical operating power, we applied the 8 percent difference to the peak efficiency estimate in the NPRM. For the final rule, the operational efficiency of the fuel cell system (i.e., represented by drive cycle efficiency) is about 61 percent.

For the final rule, we combined the revised fuel cell system efficiency with the BEV powertrain efficiency (i.e., the combined inverter, gearbox, and e-motor efficiencies) as a total FCEV efficiency to account for losses that take place before the remaining energy arrives at the axle. The final FCEV powertrain efficiencies, ranging from 51 percent to 57 percent, were used to size the hydrogen storage tanks and to determine the hydrogen usage and related costs.

As described in RIA Chapter 2.5.1.2.2, we included additional energy requirements for air conditioning.<sup>624</sup> For battery conditioning, since the batteries in FCEVs have the same characteristics as batteries for BEVs, we employed the same methodology used for BEVs.

As described in RIA Chapter 2.5.1.2.1, we converted FCEV energy consumption (kWh) into hydrogen weight using an energy content of 33.33 kWh per kg of hydrogen. In our analysis, 95 percent of the hydrogen in the tank ("usable H<sub>2</sub>") can be accessed. This is based on targets for light-duty vehicles, where a 700-bar hydrogen fuel tank with a capacity of 5.9 kg has 5.6 kg of usable hydrogen.<sup>625</sup> Furthermore, we added 10 percent to the tank size in HD TRUCS to avoid complete depletion of hydrogen from the tank.

<sup>622</sup> Net system power is the gross stack power minus balance of plant losses. This value can be called the rated power.

<sup>623</sup> Huya-Kouadio, Jennie and Brian D. James. "Fuel Cell Cost and Performance Analysis: Presentation for the DOE Hydrogen Program; 2023 Annual Merit Review and Peer Evaluation Meeting". Strategic Analysis. June 6, 2023. Available online: [https://www.hydrogen.energy.gov/docs/hydrogenprogramlibraries/pdfs/review23/fc353\\_james\\_2023\\_o-pdf.pdf](https://www.hydrogen.energy.gov/docs/hydrogenprogramlibraries/pdfs/review23/fc353_james_2023_o-pdf.pdf).

<sup>624</sup> FCEVs use waste heat from the fuel cell for heating, and that ventilation operates the same as it does for an ICE vehicle.

<sup>625</sup> U.S. DRIVE Partnership. "Target Explanation Document: Onboard Hydrogen Storage for Light-Duty Fuel Cell Vehicles". U.S. Department of Energy. 2017. Available online: [https://www.energy.gov/sites/prod/files/2017/05/f34/fcto\\_targets\\_onboard\\_hydro\\_storage\\_explanation.pdf](https://www.energy.gov/sites/prod/files/2017/05/f34/fcto_targets_onboard_hydro_storage_explanation.pdf).

*E. Technology, Charging Infrastructure, and Operating Costs*

As discussed in section II.D.1, we considered ICE vehicles with GHG-reducing technologies. For the modeled potential compliance pathway, we did not include additional technologies on ICE vehicles beyond those technologies we analyzed to support the Phase 2 MY 2027 standards. Therefore, there are not any incremental cost increases for the Phase 3 standards associated with the ICE vehicles in this potential compliance pathway. Thus, this subsection focuses on the costs associated with BEV and FCEV technologies and infrastructure. In the following subsections, we first discuss BEV technology (section II.E.1) and associated EVSE technology costs (section II.E.2) and FCEV technology costs (section II.E.3). RIA Chapter 2.4.3 (for BEVs) and RIA Chapter 2.5.2 (for FCEVs) includes the cost estimates for each of the 101 applications. We then discuss the IRA tax credits we quantified in our analysis for BEV and FCEV technologies in section II.E.4. Our assessment of operating costs for ICE vehicle, BEV and FCEV technologies including the fuel or electricity costs, along with the maintenance and repair costs, insurance, and taxes are presented in section II.E.5. This subsection concludes with the overall payback analysis for BEV and FCEV technologies in section II.E.6. RIA Chapter 2.8.2 includes the vehicle technologies costs, EVSE costs, operating costs, and payback results for each of the 101 HD applications for BEV and FCEV technologies. The technology costs for BEV and FCEV technologies aggregated into MOVES categories are also described in detail in RIA Chapter 3.1.

As we have noted several times throughout this preamble, there are other examples of possible compliance pathways for meeting the final standards that do not involve the widespread adoption of BEV and FCEV technologies. In section II.F.4, we provide examples of additional potential compliance pathways, including the associated technology and operating costs of those technologies.

1. BEV Technology Costs

The incremental cost of a BEV powertrain system is calculated as the cost difference from the comparable vehicle powertrain with an ICE, where the ICE vehicle powertrain cost is a sum of the costs of the engine (including the projected cost of the HD2027 standards), alternator, gearbox (transmission), starter, torque converter, and final drive system. Heavy-duty BEV powertrain

costs consist of the battery, electric motor, inverter, converter, onboard charger, power electronics controller, transmission or gearbox, final drive, and electrical accessories. RIA Chapter 2.4.3 contains additional detail on our cost projections for each of these components.

Battery costs are widely discussed in the literature because they are a key driver of the cost of a HD electric vehicle. The per unit cost of the battery, in terms of \$/kWh, is the most common metric in determining the cost of the battery as the final size of the battery may vary significantly between different applications. The total battery pack cost is a function of the per unit kWh cost and the size (in terms of kWh) of the pack.

There are numerous projections for battery costs and battery pricing in the literature that cover a range of estimates. Sources do not always clearly define what is included in their cost or price projections, nor whether the projections reflect direct manufacturing costs incurred by the manufacturer or the prices seen by the end-consumer. Except as noted in the NPRM, the values in the literature we used to develop the battery pack costs used in the NPRM were developed prior to enactment of the Inflation Reduction Act. In the NPRM, we requested battery cost data for heavy-duty vehicles. 88 FR 25981.

We received a significant number of comments regarding the values we used for the battery costs, as well as comments regarding application of a learning curve to battery costs. Commenters suggested values both higher and lower than the values used in the proposal. Justifications from commenters for higher than proposal values included volatility in the minerals market, adjustment to rate of learning, inability to capture some or all of BIL and IRA incentives, as well as general uncertainty within the sector. Justifications from commenters for lower than proposal values included incentives from BIL and IRA, rapid development in the EV sector including the light-duty market, cheaper chemistries including LFP and sodium ion batteries, and (more) recent stabilization within the lithium market.

One commenter recommended that EPA use a figure roughly 26 percent greater than estimated at proposal; for example, they believe the MY 2027 battery pack costs should be \$183/kWh. Two other commenters echoed that commenter's recommended battery costs. Another commenter shared four CBI battery pack costs for MY 2029 under four scenarios. These scenarios included smaller and larger battery

packs, and with low and high lithium raw material costs. Another commenter questioned EPA's reliance on the ICCT value for battery pack cost given ICCT's caution about uncertainty within the market for this sector. The commenter further maintained that the ICCT White Paper did not adequately explain or cite empirical support for averaging of the values, and that upper and lower bounds should be adopted instead for HD TRUCS battery cost inputs.

Although some commenters believe the battery costs used for the NPRM are too low, others believe the battery costs used were too high. One commenter referenced a Roush report of HDV battery costs of \$98/kWh in MY 2030 and \$88/kWh in MY 2032 without an IRA adjustment. Another commenter believes the battery used for HDVs will be less conservative than the one modeled by EPA in terms of both specific energy and energy density, and that this conservativeness is then reflected in EPA's estimates of battery costs. This commenter's cited BloombergNEF, where battery costs are projected to decline to \$100/kWh by 2026 as a result of mineral price stabilization. Another commenter referenced an ICCT report where batteries would reach a cost of \$120/kWh at the pack level by 2030 but did not put forward a battery pack cost estimate of their own.

Another point of disagreement from commenters is the methodology used for assessing the effects of learning by doing<sup>626</sup> on battery pack costs between 2027 and 2032. One commenter suggests that faster learning curves may be appropriate for BEVs due to novel battery chemistries that can disrupt markets and increase competition; faster-than-expected moderation of pandemic-induced supply chain disruption; battery pack economies of scale; and the tendency of battery outlooks to underestimate future learning curves. Another commenter believes learning for BEVs should start in 2022 rather than in 2027 which was used in the NPRM analysis, the logic being that learning commences as production commences. Applying EPA's learning curve starting in 2022 would have the effect of reducing cost reductions attributable to learning in the years of the Phase 3 rule. Another commenter agrees with this commenter as to when learning commences, but

<sup>626</sup> Manufacturing learning is the process by which costs for items are reduced as manufacturing practices become more efficient through improvements in manufacturing methods. This is represented as a factor applied to a base year and applied year over year to reflect a drop in cost for year over year manufacturing improvements.

maintained that the learning curve for ZEVs should be less sharp than for ICE because ZEVs have fewer moving parts. The commenter also believes some components have not achieved the economies of scale that is required for the cost inputs used in HD TRUCS. Lastly, this commenter stated that the learning curve for LD was inapplicable to HD vehicles given the difference in duty cycles, durability, and the resulting difference in battery sizes. Another commenter took a different view on learning from the LD market, stating that learning should have already started in the light-duty industry and this means any further learning in HD will be smaller than what EPA estimated in the proposed rule. More detailed discussion of learning used for ZEVs can be found RIA Chapter 3.2.1 and the comments received on learning and responses can be found in RTC section 12.3.

For the final rule, we re-evaluated our values used for battery cost in MY 2027 based on comments provided by stakeholders, as well as on additional

studies provided by the FEV and the Department of Energy BatPaC model.<sup>627</sup> We considered a wide range of MY 2027 battery pack costs ranging from the \$183/kWh cited by manufacturers in comments to \$101/kWh projected by ANL that reflects an average of the nickel-manganese containing layered oxides (Ni/Mn) and the lithium iron phosphate (LFP) HD battery costs.<sup>629</sup> ANL conducted this study to estimate the cost of U.S.-produced battery packs for light and heavy-duty vehicles using their BatPaC tool. We also contracted FEV to conduct a cost analysis to inform the final rule analysis. The FEV study projected costs for HD battery packs in MY 2027 to range from \$128 to \$143/kWh. As described in RIA Chapter 2.4.3, for MY 2027, we project a battery cost value of \$120/kWh (2022\$) based on a weighted average of the battery cost values from DOE’s study, values received from commenters, and the FEV cost study.

We have traditionally applied learning impacts using learning factors

applied to a given cost estimate as a means of reflecting learning-by-doing effects on future costs.<sup>630</sup> We are continuing to do so in this rulemaking. We agree with some parts of the comments regarding the NPRM’s assessment of learning for ZEV components. In the final rule, we adjusted the learning to reflect a less steep portion of the learning curve in MY 2027 and beyond compared to the learning we used in the NPRM analysis. The learning curve we used for the final rule aligns closely with the learning applied by ANL in their BatPaC modeling to develop battery costs for heavy-duty BEVs in MYs 2027 through 2032.<sup>631</sup> We calculated the MYs 2028–2032 battery costs using learning scalars as shown in RIA Chapter 3.2.1, resulting in the values shown in Table II–14 represent the direct manufacturing pack-level battery costs in HD TRUCS using 2022\$. These values are used for battery costs in both BEVs and FCEVs.

**Table II-14 Direct Manufacturing Pack-Level Battery Costs in HD TRUCS (2022\$)**

Model Year	2027	2028	2029	2030	2031	2032
Battery Cost (\$/kWh)	120	113	107	103	100	97

As noted, batteries are the most significant cost component for BEVs, and the IRA section 13502, “Advanced Manufacturing Production Credit,” has the potential to significantly reduce the cost of BEVs whose batteries are produced in the United States. As discussed in section II.E.4, the IRA Advanced Manufacturing Production Credit provides up to \$45 per kWh tax credits (with specified phase-out in CYs 2030–2033) for the production and sale of battery cells and modules, and additional tax credits for producing critical minerals such as those found in batteries, when such components or minerals are produced in the United States and other criteria are met. Our approach to accounting for the IRA Advanced Manufacturing Production Credit in our analysis is explained in section II.E.4.

An electric drive (e-drive)—another major component of an electric vehicle—includes the electric motor, an

inverter, a converter, and optionally, a transmission system or gearbox. The electric energy in the form of direct current (DC) is provided from the battery; an inverter is used to change the DC into alternating current (AC) for use by the motor. The motor then converts the electric power into mechanical or motive power to move the vehicle. Conversely, the motor also receives AC from the regenerative braking, whereby the inverter changes it to DC to be stored in the battery. The transmission reduces the speed of the motor through a set of gears to an appropriate speed at the axle. An emerging trend is to replace the transmission and driveline with an e-axle, which is an electric motor integrated into the axle, e-axes are not explicitly covered in our cost analysis.<sup>632</sup>

A few commenters disagreed with the cost used by EPA at proposal for the electric motor, providing values that were lower and higher than the

proposal. One commenter references Roush reports of \$8/kW for 2030 and 2032, much lower than EPA’s value. Another commenter provided CBI values of e-axle costs. Another commenter cited an ICCT report that projected cost reductions of 60 percent by 2030 and that further projected that the price of electric powertrain systems, including the transmission, motor, and inverter, would reach \$23/kW. Another commenter is concerned that the market will demand different ZEV architectures depending on the application (direct drive, e-axle, and portal axle) and that each of these technologies will have a different \$/kW value due to differences in component costs and their respective manufacturing process.

For the final rule, we continue to include the direct manufacturing cost for e-drive in HD TRUCS. Similar to the battery cost, there is a range of electric drive cost projections available in the literature and per stakeholder

<sup>627</sup> FEV Consulting. “Heavy Duty Commercial Vehicles Class 4 to 8: Technology and Cost Evaluation for Electrified Powertrains—Final Report”. Prepared for EPA. March 2024.

<sup>628</sup> DOE BatPaC Study.

<sup>629</sup> Argonne National Laboratory. “Cost Analysis and Projections for U.S.-Manufactured Automotive Lithium-ion Batteries.” February 2024.

<sup>630</sup> See the 2010 light-duty greenhouse gas rule (75 FR 25324, May 7, 2010); the 2012 light-duty

greenhouse gas rule (77 FR 62624, October 15, 2012); the 2011 heavy-duty greenhouse gas rule (76 FR 57106, September 15, 2011); the 2016 heavy-duty greenhouse gas rule (81 FR 73478, October 25, 2016); the 2014 light-duty Tier 3 rule (79 FR 23414, April 28, 2014); the heavy-duty NOx rule (88 FR 4296, January 24, 2023).

<sup>631</sup> Argonne National Laboratory. “Cost Analysis and Projections for U.S.-Manufactured Automotive

Lithium-ion Batteries.” Figure 4, page 16. February 2024.

<sup>632</sup> E-axes are an emerging technology that have potential to realize efficiency gains because they have fewer moving parts. Though we did not quantify their impact explicitly due to a lack of data and information at the time of our analysis and to remain technology-neutral, the technology can be used to comply with this regulation.

comments. One reason for the disparity across the literature is what is included in each for the “electric drive”; some cost estimates include only the electric motor and others present a more integrated model of e-motor/inverter/gearbox combination. Another reason for the disparity is described by one of

the commenters: the demand for e-drive will be different for different applications. As described in detail in RIA Chapter 2.4.3.2.1, EPA’s MY 2027 e-motor cost, shown in Table II–15, comes from ANL’s 2022 BEAN tool and is a linear interpolation of the average of the high- and low-tech scenarios for 2025

and 2030, adjusted to 2022\$.<sup>633</sup> We then calculated MY 2028–2032 per-unit cost from the power of the motor (RIA Chapter 2.4.1.2) and \$/kW of the e-motor shown in Table II–15, and using an EPA estimate of market learning shown in RIA Chapter 3.2.1.

**Table II-15 E-Motor Direct Manufacturing Costs in HD TRUCKS (\$/kW) (2022\$)**

Model Year	2027	2028	2029	2030	2031	2032
E-Drive Cost (\$/kW)	21	20	19	18	17	17

Gearbox and final drive units are used to reduce the speed of the motor and transmit torque to the axle of the vehicle. In HD TRUCKS for the proposal, we set the MY 2027 final drive DMC at \$1,500/unit, based on ANL’s 2022 BEAN model for vocational vehicles.<sup>634</sup> For tractors, the final drive cost is doubled the cost of vocational vehicles because in general they have additional drive axles. We did not receive any data to support different values, therefore, we adjusted the values used in the proposal to 2022\$ and applied the ICE learning effects shown in RIA Chapter 3.2.1 for MY 2028 through MY 2032.<sup>635</sup> Final drive costs for BEVs are shown in RIA Chapter 2.4.3.2.

The cost of the gearbox varies depends on the vehicle weight class and duty cycle. In our assessment, all light heavy-duty BEVs are direct drive and have no transmission and no cost, consistent with ANL’s 2022 BEAN model. We determined the gearbox costs for medium heavy-duty and heavy heavy-duty BEVs in HD TRUCKS from ANL’s BEAN tool.<sup>636</sup> BEV Gearbox costs are shown are in RIA Chapter 2.4.3.2.

The costs of a power converter and electric accessories in HD TRUCKS for both the proposal and final rule came from ANL’s 2022 BEAN tool.<sup>637</sup> For the final rulemaking version of HD TRUCKS, we updated the term Power Electronics to Power Converter, which represents the cost of a DC–DC converter (\$1500 in 2020\$).<sup>638</sup> DC–DC converters transfer energy (*i.e.*, they “step up” or “step down” voltage) between higher- and

lower-voltage systems, such as from a high-voltage battery to a common 12V level for auxiliary uses.<sup>639</sup> We identified an additional cost in BEAN that we added as Auxiliary Converter.<sup>640</sup> We also revised the Electric Accessories costs to include both the electric accessories costs (\$4500 in 2020\$) and the vehicle propulsion architecture (VPA) costs (\$186 in 2020\$) from ANL’s 2022 BEAN. These values were converted to 2022\$ and include the BEV learning effects included in RIA Chapter 3.2 and are shown in RIA Chapter 2.4.3.2.

When using a Level 2 charging plug, an on-board charger converts AC power from the grid to usable DC power via an AC–DC converter. When using a D fast charger (DCFC), any AC–DC converter is bypassed, and the high-voltage battery is charged directly. The costs we used in the NPRM were based on ANL’s BEAN model, which was \$38 in MY 2027.<sup>641</sup> In the peer review of HD TRUCKS, one reviewer noted that the value used in the NPRM was unrepresentative of the actual costs and suggested a cost of \$600.<sup>642</sup> In light of this critique, EPA has increased the on-board charger costs to \$600 in MY 2027, as further discussed in RIA Chapter 2.4.3.3. We then calculated the MY 2028–2032 costs using the learning curve shown in RIA Chapter 3.2.1.

The total upfront BEV direct manufacturing cost is the summation of the per-unit cost of the battery, motor, power electronics, on-board charger, gearbox, final drive, and accessories.

The total direct manufacturing technology costs for BEVs for each of the 101 vehicle types in HD TRUCKS can be found in RIA Chapter 2.4.3.5 for MY 2027, MY 2030, and MY 2032.

2. EVSE Costs

As described section II.D.5.iv, we used a mix of depot and public charging in our final rule analysis of HD BEV technologies for our technology packages to support the feasibility of the standards. In that analysis, most vocational vehicles and some lower travel, return-to-base day cab tractors rely on depot charging while long-haul vehicles (sleeper cab and longer-range day cab tractors) and coach buses utilize public charging starting with MY 2030. In HD TRUCKS we evaluated BEVs for 97 of the 101 vehicle types. Of those, we assign depot charging costs to 89 vehicle types starting in MY 2027 and public charging costs to eight vehicle types starting in MY 2030.

In our analysis of depot charging infrastructure costs, we account for the cost to purchasers to procure both EVSE (which we refer to as the hardware costs) as well as costs to install the equipment. These installation costs typically include labor and supplies, permitting, taxes, and any upgrades or modifications to the on-site electrical service. We developed our EVSE cost estimates for the NPRM from available literature, looking at a range of costs (low to high) for each of the four EVSE types. As discussed in RIA Chapter 1.3.2, the IRA extends and modifies a Federal tax credit under section 30C of

<sup>633</sup> Argonne National Laboratory. VTO HFTO Analysis Reports—2022. “ANL—ESD—2206 Report—BEAN Tool—MD HD Vehicle Techno-Economic Analysis.xlsm”. Available online: <https://anl.app.box.com/s/an4nx0v2xpudxtpsnkhd5peimzu4j1hk/folder/242640145714>.

<sup>634</sup> Argonne National Laboratory. VTO HFTO Analysis Reports—2022. “ANL—ESD—2206 Report—BEAN Tool—MD HD Vehicle Techno-Economic Analysis.xlsm”. Available online: <https://anl.app.box.com/s/an4nx0v2xpudxtpsnkhd5peimzu4j1hk/folder/242640145714>.

<sup>635</sup> For the final rule, we updated the learning curve for BEV (and FCEV) final drive costs to be consistent with the ICE learning curve since we are

basing final drive costs on a component that is similar to an ICE vehicle final drive.

<sup>636</sup> Argonne National Laboratory. VTO HFTO Analysis Reports—2022. “ANL—ESD—2206 Report—BEAN Tool—MD HD Vehicle Techno-Economic Analysis.xlsm”. Available online: <https://anl.app.box.com/s/an4nx0v2xpudxtpsnkhd5peimzu4j1hk/folder/242640145714>.

<sup>637</sup> Argonne National Laboratory. VTO HFTO Analysis Reports—2022. “ANL—ESD—2206 Report—BEAN Tool—MD HD Vehicle Techno-Economic Analysis.xlsm”. Available online: <https://anl.app.box.com/s/an4nx0v2xpudxtpsnkhd5peimzu4j1hk/folder/242640145714>.

<sup>638</sup> In the 2022 version of BEAN, the “BEAN results” tab, this is also represented as “pc2 DC/DC booster”.

<sup>639</sup> <https://info.ornl.gov/sites/publications/Files/Pub136575.pdf>.

<sup>640</sup> In the 2022 version of BEAN, the “Cost & LCOE & CCM” tab, this is called a “pc1 DC/DC ESS”. In the “Autonomie Out” tab, this is linked to a DC/DC buck converter cost.

<sup>641</sup> Argonne National Lab, Vehicle & Mobility Systems Group, TechScope, found at: <https://vms.taps.anl.gov/tools/techscope/> (accessed December 2023).

<sup>642</sup> U.S. EPA. EPA Responses to HD TRUCKS Peer Review Comments. February 2024.

the Internal Revenue Code that could cover up to 30 percent of the costs for businesses to procure and install EVSE on properties located in low-income or non-urban census tracts if prevailing wage and apprenticeship requirements are met.<sup>643</sup> To reflect our expectation

that this tax credit—as well as grants, rebates, or other funding available through the IRA—could significantly reduce the overall infrastructure costs paid by BEV and fleet owners for depot charging, we used the low end of our EVSE cost ranges in the NPRM

infrastructure cost analysis. These values are summarized in Table II–16. We requested comment, including data, on our approach and assessment of current and future costs for charging equipment and installation. 88 FR 25982.

**Table II-16 EVSE Costs in NPRM analysis (2021\$)**

Charging Type	Cost per EVSE Port
Level 2 (19.2 kW)	\$10,541
DCFC—50 kW	\$31,623
DCFC—150 kW	\$99,086
DCFC—350 kW	\$162,333

We received multiple comments about these costs. One industry commenter suggested that EPA should use the midpoint rather than the low end of our EVSE cost ranges. While one manufacturer commenter suggested our assumed EVSE installation costs were too high, other manufacturer commenters said that we underestimated costs for high-power EVSE. Another commenter suggested we should directly account for the savings from the 30C tax credit.

As described in RIA Chapter 2.6.2.1, we made several changes in how we estimate the EVSE costs incurred for depot charging in the final rule analysis. For the NPRM analysis, we developed the DCFC costs from a 2021 study (Borlaug et al. 2021) specific to heavy-duty electrification at charging depots. After reviewing new information on EVSE costs provided in comments as well as literature released since the publication of the NPRM, we determined it was appropriate to increase the underlying hardware and installation cost ranges we considered for DCFC–150 kW and DCFC–350 kW

based on a new NREL study issued in 2023 to reflect the most up-to-date information available.<sup>644</sup> After further consideration, including consideration of comments on this issue and availability of a new DOE analysis<sup>645</sup> of the average value of the 30C tax credit for HD charging infrastructure, we have updated the depot EVSE costs in our final rule analysis to reflect a quantitative assessment of average savings from the tax credit.

As noted, the 30C tax credit could cover up to 30 percent of the costs for fleets or other businesses to procure and install EVSE on properties located in low-income or non-urban census tracts if prevailing wage and apprenticeship requirements are met. DOE projects that businesses will meet prevailing wage and apprenticeship requirements in order to qualify for the full 30 percent tax credit,<sup>646</sup> and estimates that 60 percent<sup>647</sup> of depots will be located in qualifying census tracts based on its assessment of where HD vehicles are currently registered, the location of warehouses and other transportation facilities that may serve as depots, and

the share of the population living in eligible census tracts.<sup>648</sup> Taken together, DOE estimates an average value of this tax credit of 18 percent of the installed EVSE costs at depots. We apply this 18 percent average reduction to the EVSE costs used in HD TRUCS for the final rulemaking (FRM).

As noted, for the NPRM, we had used the low end of our EVSE cost ranges to reflect our expectation that the tax credit would significantly reduce EVSE costs to purchasers (*i.e.*, we used the low end to reflect typical EVSE hardware and installation costs less savings from the tax credit). Since we explicitly model the tax credit reductions for the FRM analysis, we determined it was appropriate to switch from using the low to the midpoint of EVSE cost ranges for all EVSE types to better reflect typical hardware and installation costs before accounting for the tax credit savings. The resulting hardware and installation costs for EVSE are shown in Table II–17 before and after applying the tax credit. We use values in the right column in our depot charging analysis.

<sup>643</sup> IRA section 13404, “Alternative Fuel Refueling Property Credit” under section 26 U.S.C. 30C, referred to as 30C in this document A \$100,000 per item cap applies.

<sup>644</sup> Wood, Eric et al. “The 2030 National Charging Network: Estimating U.S. Light-Duty Demand for Electric Vehicle Charging Infrastructure,” 2023. Available at: <https://driveelectric.gov/files/2030-charging-network.pdf>.

<sup>645</sup> U.S. DOE. “Estimating Federal Tax Incentives for Heavy Duty Electric Vehicle Infrastructure and

for Acquiring Electric Vehicles Weighting Less Than 14,000 Pounds.” Memorandum, March 2024.

<sup>646</sup> As noted in DOE’s assessment, the “good faith effort” clause applicable to the apprenticeship requirement suggests that it is unlikely that businesses will not be able to meet it and take advantage of the full 30 percent tax credit (if otherwise eligible).

<sup>647</sup> This estimate may be conservative as DOE notes that its analysis did not factor in that fleets may choose to site depots at charging facilities in

eligible census tracts to take further advantage of the tax credit. In addition, we note that DOE estimated 68 percent of heavy-duty vehicles are registered in qualifying census tracts suggesting the share of EVSE installations at depots that are eligible for the 30C tax credit could be higher.

<sup>648</sup> U.S. DOE. “Estimating Federal Tax Incentives for Heavy Duty Electric Vehicle Infrastructure and for Acquiring Electric Vehicles Weighting Less Than 14,000 Pounds.” Memorandum, March 2024.

**Table II-17 Combined Hardware and Installation EVSE Costs (2022\$)**

Charging Type	Cost Before Tax Credit	Cost After Tax Credit
Level 2—19.2 kW	\$16,991	\$13,932
DCFC—50 kW	\$63,432	\$52,014
DCFC—150 kW	\$154,200	\$126,444
DCFC—350 kW	\$232,700	\$190,814

Both hardware and installation costs could vary over time. For example, hardware costs could decrease due to manufacturing learning and economies of scale. Recent studies by ICCT assumed a 3 percent reduction in hardware costs for EVSE per year to 2030.<sup>649</sup> By contrast, installation costs could increase due to growth in labor or material costs. Installation costs are also highly dependent on the specifics of the site including whether sufficient electric capacity exists to add charging infrastructure and how much trenching or other construction is required. If fleet owners choose to install charging stations at easier, and therefore, lower cost sites first, then installation costs could rise over time as stations are developed at more challenging sites. One of the ICCT studies found that these and other countervailing factors could result in the average cost of a 150 kW EVSE port in 2030 being similar (~3 percent lower) to that in 2021.<sup>651</sup>

After considering the uncertainty on how costs may change over time, we kept the combined hardware and installation costs per EVSE port constant for the NPRM analysis. We received only a few comments on this topic. Several commenters noted that EVSE equipment costs would likely decrease over time and one suggested we incorporate reductions to account for learning rates. However, the other commenters agreed with us that while hardware costs may decline in the

future, installation costs could rise, and therefore they supported our approach to keep combined hardware and installation costs constant. For the final rule analysis we continued our proposed approach of not varying costs over time on the same bases included in the NPRM and it retains a conservative approach to EVSE costs.

How long a vehicle is off-shift and parked at a depot, warehouse, or other home base each day is a key factor in determining what type of charging infrastructure could meet its needs. We refer to this as depot dwell time. This depot dwell time depends on a vehicle's duty cycle. For example, a school bus or refuse truck may be parked at a depot in the afternoon or early evening and remain there until the following morning whereas a transit bus may continue to operate throughout the evening. Even for a specific vehicle, off-shift depot dwell times may vary between weekends and weekdays, by season, or due to other factors that impact its operation.

The vehicles in our depot charging analysis span a wide range of vehicle types and duty cycles, and we expect their dwell times to vary accordingly. In the NPRM, we used a dwell time of 12 hours for every type of HD vehicle informed by our examination of start and idle activity data<sup>652</sup> for 564 commercial vehicles.<sup>653</sup> In order to better understand how depot dwell times might vary by vehicle application and class for our final rule analysis, we worked with NREL through an interagency agreement between EPA and the U.S. Department of Energy. NREL analyzed several data sets for this effort: General Transit Feed Specification (GTFS) data for about 21,700 transit buses,<sup>654</sup> operating data for nearly 300 school buses from NREL's FleetDNA database, and a set of fleet

telematics data from Geotab's Altitude platform covering about 13,600 medium- and heavy-duty trucks in seven geographic zones<sup>655</sup> selected to be nationally representative.<sup>656</sup> The truck dataset includes a variety of classes and vocations. As described in Bruchon et al. 2024,<sup>657</sup> NREL separately analyzed data for four class combinations (2b-3, 4-5, 6-7, and 8) and four vocations defined by vehicles' travel patterns (door to door, hub and spoke, local, and regional). This results in sixteen unique freight vehicle categories.<sup>658</sup>

Across all vehicle categories, NREL provided national dwell time distributions that describe the number of hours vehicles spend at their primary domicile (or depot). For each of the sixteen freight categories as well as for school buses, these dwell durations reflect the total daily hours vehicles spent at their depots on operational weekday or weekend days regardless of whether the vehicles were parked for one continuous period or across multiple stops throughout the day. For transit buses, NREL estimated the typical time buses spent when parked at their depot overnight, *i.e.*, the time between the end of the last shift of the day and the first shift the following

<sup>655</sup> The seven zones are: San Jose-Sunnyvale-Santa Clara, CA; Pittsburgh, PA; Evansville, IN-KY; Lafayette, LA; Janesville-Beloit, WI; Southern ID non-Metropolitan Statistical Areas (MSA); Eastern CA non-MSAs. Data used was collected between September 7 and September 30, 2022. See Bruchon et al. 2024 for details on variables used to select the seven representative zones.

<sup>656</sup> Bruchon, Matthew, Brennan Borlaug, Bo Liu, Tim Jonas, Jiayun Sun, Nhat Le, Eric Wood. "Depot-Based Vehicle Data for National Analysis of Medium- and Heavy-Duty Electric Vehicle Charging". National Renewable Energy Laboratory. NREL/TP-5400-88241. February 2024. Available online: <https://www.nrel.gov/docs/fy24osti/88241.pdf>.

<sup>657</sup> Bruchon, Matthew, Brennan Borlaug, Bo Liu, Tim Jonas, Jiayun Sun, Nhat Le, Eric Wood. "Depot-Based Vehicle Data for National Analysis of Medium- and Heavy-Duty Electric Vehicle Charging". National Renewable Energy Laboratory. NREL/TP-5400-88241. February 2024. Available online: <https://www.nrel.gov/docs/fy24osti/88241.pdf>.

<sup>658</sup> NREL's report also includes information on a long-distance vocation. However, we have excluded these from our depot charging analysis because, as noted in Bruchon et al. 2024, the long-distance trucks in the sample are less likely to meet the criteria for depot-based travel.

<sup>649</sup> Minjares, Ray, Felipe Rodriguez, Arijit Sen, and Caleb Braun. "Infrastructure to support a 100% zero-emission tractor-trailer fleet in the United States by 2040". Working Paper 2021-33. The International Council on Clean Transportation. September 2021. Available online: <https://theicct.org/sites/default/files/publications/ze-tractor-trailer-fleet-us-hdvs-sept21.pdf>.

<sup>650</sup> Bauer, Gordon, Chih-Wei Hsu, Mike Nicholas, and Nic Lutsey. "Charging Up America: Assessing the Growing Need for U.S. Charging Infrastructure Through 2030". The International Council on Clean Transportation, July 2021. Available online: <https://theicct.org/wp-content/uploads/2021/12/charging-up-america-jul2021.pdf>.

<sup>651</sup> Bauer, Gordon, Chih-Wei Hsu, Mike Nicholas, and Nic Lutsey. "Charging Up America: Assessing the Growing Need for U.S. Charging Infrastructure Through 2030". The International Council on Clean Transportation, July 2021. Available online: <https://theicct.org/wp-content/uploads/2021/12/charging-up-america-jul2021.pdf>.

<sup>652</sup> Zhang, Chen; Kotz, Andrew; Kelly, Kenneth "Heavy-Duty Vehicle Activity for EPA MOVES." National Renewable Energy Laboratory. 2021. Available online: <https://data.nrel.gov/submissions/168>.

<sup>653</sup> The dataset had been analyzed as a joint effort between EPA and NREL to inform EPA's MOVES model.

<sup>654</sup> Both GTFS schedule and real-time data were utilized along with information from the National Transit Database.



service day with separate estimates for weekdays, Saturdays, and Sundays. Days on which vehicles were not operated were excluded from the samples.<sup>659</sup>

As described in RIA Chapter 2.6.2.1.4, we mapped the depot dwell durations from the 18 unique combinations of vocations and class types (*i.e.*, the 16 freight vehicle categories plus transit and school buses) in NREL’s analysis to the applicable vehicle types in our HD TRUCS model. As shown in Table 2–78 of the RIA, dwell times in HD TRUCS range from 7.4 hours to 14.5 hours, reflecting the wide range of vehicle types considered in our analysis. (See RIA Chapter 2.6.2.1.4 for a more detailed discussion of this analysis.)

For the NPRM, we assumed that each vehicle using Level 2 charging would have its own EVSE port, while up to two vehicles could share DCFC if charging needs could be met within the assumed dwell time. While one commenter asserted that it is unreasonable to assume two vehicles could share a DCFC port, and another supported our NPRM approach, we received several other comments that the constraints on EVSE sharing in our NPRM analysis were too limiting. In our final rule analysis, we updated our approach and project that up to two vocational vehicles can share one EVSE port. For tractors, which tend to be part of larger fleets, we project that up to four vehicles can share one EVSE port. However, in both cases, we only model vehicles as sharing EVSE ports if there is sufficient dwell time for each vehicle to meet its charging needs. We note that for some of the vehicle types we evaluated, higher numbers of vehicles could share EVSE ports and still meet their daily electricity consumption needs. However, in our final rule HD TRUCS analysis we limit sharing to two vocational vehicles and four tractors per port as a conservative approach for calculating EVSE costs per vehicle.

As discussed in section II.D.2.iii.c, EPA acknowledged at proposal that there could be additional infrastructure needs beyond those associated with the charging equipment itself. 88 FR 25982. Commenters emphatically agreed and focused on three areas of concern, electrical power generation, transmission, and distribution. Our consideration of comments and final rule analysis took a close look at power generation and transmission. Our analysis shows that systems and

processes exist to handle the rule’s impact on power generation and transmission, including when considered in combination with projections of other impacts on power generation and transmission based on our assessments at the time of this final rule. See RTC section 7.1; see also RIA Chapter 1.6. We also considered comments and took a close look at electrical grid distribution systems. A first of its kind Multi-State Transportation Electrification Impact Study (TEIS) was conducted by DOE to evaluate the potential that some geographic areas and some users will require grid distribution buildout updates, and to assess associated time and cost in recognition that, depending on the type of buildout needed, significant implementation time and cost could exist.<sup>660</sup> In the NPRM, we assumed that utilities would cover the electrical power, transmission, and distribution upgrade costs. DRIA 2.6.5.1. For our final rule analysis, we identify distribution buildout costs with the TEIS, power generation and transmission costs with the Integrated Planning Model (IPM) and Retail Price Model (RPM) run by ICF and account for these costs within the charging costs, as discussed in section II.E.5.ii. See generally section II.D.2.iii.c and RTC section 7 (Distribution).

### 3. FCEV Technology Costs

FCEVs and BEVs include many of the same components such as a battery pack, e-motor, power electronics, gearbox unit, final drive, and electrical accessories. Therefore, we used the same costs for these components across vehicles for the same applications; for detailed descriptions of these components, see RIA Chapter 2.4.3. In this subsection and RIA Chapter 2.5.2, we present the costs for components for FCEVs that are different from a BEV. These components include the fuel cell system and onboard hydrogen fuel tank. The same energy cell battery \$/kWh costs used for BEVs are used for fuel cell vehicles, but the battery size of a comparable FCEV is smaller.

#### i. Fuel Cell System Costs

The fuel cell stack is the most expensive component of a fuel cell system,<sup>661</sup> which is the most expensive

part of a heavy-duty FCEV, primarily due to the technological requirements of manufacturing rather than material costs.<sup>662</sup> Fuel cells for the heavy-duty sector are expected to be more expensive than fuel cells for the light-duty sector because they operate at higher average continuous power over their lifespan, which requires a larger fuel cell stack size, and because they have more stringent durability requirements (*i.e.*, to travel more hours and go longer distances).<sup>663</sup>

Projected costs vary widely in the literature. They are expected to decrease as manufacturing matures. Larger production volumes are anticipated as global demand increases for fuel cell systems for HD vehicles, which could improve economies of scale.<sup>664</sup> Costs are also anticipated to decline as durability improves.<sup>665</sup>

For the NPRM, we relied on an average of costs from an ICCT meta-study that found a wide variation in fuel cell costs in the literature.<sup>666</sup> The costs we used in the NPRM ranged from \$200 per kW in MY 2030 to \$185 per kW in MY 2032. We requested comment on our cost data projections in the proposal.

Several commenters addressed EPA’s estimates for fuel cell costs. CARB agreed with EPA’s estimates, noting they used similar estimated values in their Advanced Clean Fleets rule proceeding. One commenter thought the NPRM fuel cell cost estimates were too high, particularly if they represent the fuel cell stack alone, based on targets published by the European Joint

Energy. June 6, 2023. Available online: [https://www.hydrogen.energy.gov/docs/hydrogenprogramlibraries/pdfs/review23/fc000\\_papageorgopoulos\\_2023\\_o.pdf](https://www.hydrogen.energy.gov/docs/hydrogenprogramlibraries/pdfs/review23/fc000_papageorgopoulos_2023_o.pdf).

<sup>662</sup> Deloitte China and Ballard. “Fueling the Future of Mobility: Hydrogen and fuel cell solutions for transportation, Volume 1”. 2020. Available online: <https://www2.deloitte.com/content/dam/Deloitte/cn/Documents/finance/deloitte-cn-fueling-the-future-of-mobility-en-200101.pdf>.

<sup>663</sup> Marcinkoski, Jason et. al. “Hydrogen Class 8 Long Haul Truck Targets”. U.S. Department of Energy. October 31, 2019. Available online: [https://www.hydrogen.energy.gov/pdfs/19006\\_hydrogen\\_class8\\_long\\_haul\\_truck\\_targets.pdf](https://www.hydrogen.energy.gov/pdfs/19006_hydrogen_class8_long_haul_truck_targets.pdf).

<sup>664</sup> Deloitte China and Ballard. “Fueling the Future of Mobility: Hydrogen and fuel cell solutions for transportation, Volume 1”. 2020. Available online: <https://www2.deloitte.com/content/dam/Deloitte/cn/Documents/finance/deloitte-cn-fueling-the-future-of-mobility-en-200101.pdf>.

<sup>665</sup> Deloitte China and Ballard. “Fueling the Future of Mobility: Hydrogen and fuel cell solutions for transportation, Volume 1”. 2020. Available online: <https://www2.deloitte.com/content/dam/Deloitte/cn/Documents/finance/deloitte-cn-fueling-the-future-of-mobility-en-200101.pdf>.

<sup>666</sup> Sharpe, Ben and Hussein Basma. “A meta-study of purchase costs for zero-emission trucks”. International Council on Clean Transportation, Working Paper 2022–09. February 2022. Available online: <https://theicct.org/publication/purchase-cost-ze-trucks-feb22/>.

<sup>659</sup> In addition, total dwell durations for school buses were only considered during the school year and stops at the depot less than one hour were excluded.

<sup>660</sup> National Renewable Energy Laboratory, Lawrence Berkeley National Laboratory, Kevala Inc., and U.S. Department of Energy. “Multi-State Transportation Electrification Impact Study: Preparing the Grid for Light-, Medium-, and Heavy-Duty Electric Vehicles”. DOE/EE–2818. U.S. Department of Energy, March 2024.

<sup>661</sup> Papageorgopoulos, Dimitrios. “Fuel Cell Technologies Overview”. U.S. Department of

Undertaking. Another commenter stated that fuel stack technology is too nascent to make any type of realistic cost estimate. They noted that existing component technologies still need to be adapted for the HD market and that fuel cell stacks are not being produced at scale now, and they stated that they do not believe accurate HD FCEV technology costs can be predicted now. Several commenters said that EPA’s estimates were too low and referred to fuel cell costs from a more recent (2023) ICCT White Paper<sup>667</sup> that updated the ICCT meta-study referenced in the NPRM.<sup>668</sup> See RTC section 3.4.3 for additional details.

We reviewed the ICCT paper that several commenters referenced. Also, due to the wide range of projected costs in the literature, EPA contracted with FEV<sup>669</sup> to independently evaluate direct manufacturing costs of heavy-duty vehicles with alternative powertrain technologies and EPA conducted an

external peer review of the final FEV report.<sup>670</sup> In the report, FEV estimated costs associated with a Class 8 FCEV-dominated long-haul tractor with graphite fuel cell stacks, which are more durable than stainless steel stacks typically used in light-duty vehicle applications. FEV leveraged a benchmark study of a commercial vehicle fuel cell stack from a supplier that serves the Class 8 market. They also built prototype vehicles in-house and relied on existing expertise to validate their sizing of tanks and stacks.<sup>671</sup> Please see RTC Chapter 3.4.3 for additional detail.

For the final rule, as described in RIA Chapter 2.5.2.1, we established MY 2032 fuel cell system DMCs using cost projections from FEV and ICCT. We weighted FEV’s work twice as much as ICCT’s because it was primary research and because some of the volumes associated with the costs in ICCT’s analysis were not transparent. We note

that this method of weighting primary research more heavily than secondary research is generally appropriate for assessing predictive studies of this nature; indeed, it is consistent with what ICCT itself did. For FEV’s work, we selected costs that align with the HD FCEV production volume that we project in our modeled potential compliance pathway’s technology packages developed for this final rule, which is roughly 10,000 units per year in MY 2032, for a DMC of \$89 per kW. For ICCT’s work, we used the 2030 value of \$301 per kW for MY 2032, since 2030 was the latest year of values referenced by ICCT from literature. Our weighted average yielded a MY 2032 fuel cell system DMC of \$160 per kW. In order to project DMCs for earlier MYs from MY 2032, we used our learning rates shown in RIA Chapter 3.2.1. This yielded the MYs 2030 and 2031 DMCs shown in Table II–18.

Table II-18: Fuel Cell System Direct Manufacturing Costs (2022\$)

Year	MY 2030	MY 2031	MY 2032
FC System	\$170/kW	\$165/kW	\$160/kW

ii. Onboard Hydrogen Fuel Tank Costs

Onboard hydrogen storage cost projections also vary widely in the literature. For the NPRM, we relied on an average of costs from the same ICCT meta-study that we used for fuel cell costs.<sup>672</sup> The values we used in the NPRM analysis ranged between \$660/kg in MY 2030 and \$612/kg in MY 2032. We requested cost data projections in the proposal.

There were few comments on hydrogen fuel tank costs. Two commenters referred to ICCT’s revised meta-study.<sup>673</sup> One commenter suggested that onboard liquid hydrogen will be required for long-distance ranges of over 500 miles in the longer-term and suggested that it is too soon to offer cost estimates for liquid tanks. See RTC section 3.4.3 for details.

Given our assessment of technology readiness for the NPRM, onboard liquid hydrogen storage tanks were not included in the potential compliance pathway that supports the feasibility and appropriateness of the standards.

Like fuel cell costs, onboard gaseous hydrogen tank costs are dependent on manufacturing volume. We reviewed the ICCT paper that several commenters referenced and contracted FEV<sup>674</sup> to independently evaluate onboard hydrogen storage tank costs for MY 2027 (2022\$) based on manufacturing volume, and EPA conducted an external peer review of the final FEV report.<sup>675</sup> Please see RTC Chapter 3.4.3 for additional detail.

Using the same approach taken for fuel cell system costs, as described in RIA Chapter 2.5.2.2, we established MY 2032 onboard storage tank DMCs using cost projections from FEV and ICCT. We

weighted FEV’s work twice as much as ICCT’s because it was primary research and because some of the volumes associated with the costs in ICCT’s analysis were not transparent. We note that this method of weighting primary research more heavily than secondary research is generally appropriate for assessing predictive studies of this nature; indeed, it is consistent with what ICCT itself did. For FEV’s work, we selected costs for roughly 10,000 units per year in MY 2032, for a DMC of \$504 per kg. For ICCT’s work, we used the 2030 value of \$844 per kW for MY 2032, since 2030 was the latest year of values referenced by ICCT from literature. Our weighted average yielded a MY 2032 fuel cell system DMC of \$617 per kW. In order to project DMCs from MY 2032 for earlier MYs, we used our learning rates shown in shown in RIA Chapter 3.2.1. This yielded the MYs

<sup>667</sup> Xie, et. al. “Purchase costs of zero-emission trucks in the United States to meet future Phase 3 GHG standards”. International Council of Clean Transportation, Working Paper 2023–10. March 2023. Available online: <https://theicct.org/wp-content/uploads/2023/03/cost-zero-emission-trucks-us-phase-3-mar23.pdf>.

<sup>668</sup> Sharpe, Ben and Hussein Basma. “A meta-study of purchase costs for zero-emission trucks”. International Council on Clean Transportation, Working Paper 2022–09. February 2022. Available online: <https://theicct.org/publication/purchase-cost-ze-trucks-feb22/>.

<sup>669</sup> FEV Consulting. “Heavy Duty Commercial Vehicles Class 4 to 8: Technology and Cost

Evaluation for Electrified Powertrains—Final Report”. Prepared for EPA. March 2024.

<sup>670</sup> ICF. “Peer Review of HD Vehicles, Industry Characterization, Technology Assessment and Costing Report”. September 15, 2023.

<sup>671</sup> FEV Consulting. “Heavy Duty Commercial Vehicles Class 4 to 8: Technology and Cost Evaluation for Electrified Powertrains—Final Report”. Prepared for EPA. March 2024.

<sup>672</sup> Sharpe, Ben and Hussein Basma. “A meta-study of purchase costs for zero-emission trucks”. International Council on Clean Transportation, Working Paper 2022–09. February 2022. Available online: <https://theicct.org/publication/purchase-cost-ze-trucks-feb22/>.

<sup>673</sup> Xie, et. al. “Purchase costs of zero-emission trucks in the United States to meet future Phase 3 GHG standards”. International Council of Clean Transportation, Working Paper 2023–10. March 2023. Available online: <https://theicct.org/wp-content/uploads/2023/03/cost-zero-emission-trucks-us-phase-3-mar23.pdf>.

<sup>674</sup> FEV Consulting. “Heavy Duty Commercial Vehicles Class 4 to 8: Technology and Cost Evaluation for Electrified Powertrains—Final Report”. Prepared for EPA. March 2024.

<sup>675</sup> ICF. “Peer Review of HD Vehicles, Industry Characterization, Technology Assessment and Costing Report”. September 15, 2023.

2030 and 2031 DMGs shown in Table II-19.

**Table II-19: Onboard Hydrogen Tank Direct Manufacturing Costs (2022S)**

Year	MY 2030	MY 2031	MY 2032
Onboard H2 Tank	\$659/kg	\$636/kg	\$617/kg

4. Inflation Reduction Act Tax Credits for HD Battery Electric Vehicles

The IRA,<sup>676</sup> which was signed into law on August 16, 2022, includes a number of provisions relevant to vehicle electrification. There are three provisions of the IRA we included within our quantitative analysis in HD TRUCS related to the manufacturing and purchase of HD BEVs and FCEVs. First, section 13502, “Advanced Manufacturing Production Credit,” provides up to \$45 per kWh tax credits under section 45X of the Internal Revenue Code (“45X”) for the production and sale of battery cells and modules when the cells and modules are produced in the United States and other qualifications are met. Second, section 13403, “Qualified Commercial Clean Vehicles,” provides for a vehicle tax credit under section 45W applicable to HD vehicles if certain qualifications are met. Third, after further consideration, including consideration of comments on this issue, we have quantitatively analyzed section 13404, “Alternative Fuel Refueling Property Credit,” tax credit under 30C for EVSE costs for the final rule. See section II.E.2 of this preamble, and IRA sections 13403, 13502, and 13404. Beyond these three tax credits, there are numerous provisions in the IRA and the BIL<sup>677</sup> that may impact HD vehicles and increase adoption of HD ZEV technologies. These range from tax credits across the supply chain, to grants which may help direct ZEVs to communities most burdened by air pollution, to funding for programs to build out electric vehicle charging infrastructure, as described in section I of this preamble and RIA Chapter 1.3.2.

Regarding the first of the provisions, IRA section 13502, “Advanced Manufacturing Production Credit,” provides up to \$45 per kWh tax credits under 45X for the production and sale of battery cells (up to \$35 per kWh) and

modules or packs<sup>678</sup> (up to \$10 per kWh) and 10 percent of the cost of producing critical minerals such as those found in batteries, when such components or minerals are produced in the United States and other qualifications are met as described in RIA Chapter 1.3.2.2. These credits begin in CY 2023 and phase down starting in CY 2030, ending after CY 2032. As further discussed in RIA Chapter 2.4.3.1, we recognize that there are currently few manufacturing plants specifically for HD vehicle batteries in the United States. We expect that the industry will respond to this tax credit incentive by building more domestic battery manufacturing capacity in the coming years, in part due to the BIL and IRA. For example, Daimler Trucks, Cummins, and PACCAR recently announced a new joint venture for a 21 GWh factory to be built in the U.S. to manufacture cells and packs initially focusing on LFP batteries for heavy-duty and industrial applications.<sup>679</sup> Tesla is expanding its facilities in Nevada to produce its Semi BEV tractor and battery cells<sup>680</sup> and Cummins has entered into an agreement with Arizona-based Sion Power to design and supply battery cells for commercial electric vehicle applications.<sup>681</sup> See the additional discussion in section II.D.2.ii of this preamble, and RTC section 17.2 (battery production) for further discussion and examples. Additionally,

<sup>678</sup> Packs would be eligible for the credit under the proposed interpretation. See 88 FR 86851.  
<sup>679</sup> Daimler Trucks North America. “Accelera by Cummins, Daimler Truck and PACCAR form a joint venture to advance battery cell production in the United States.” September 6, 2023. Available online: <https://media.daimlertruck.com/marsMediaSite/en/instance/ko/Accelera-by-Cummins-Daimler-Truck-and-PACCAR-form-a-joint-venture-to-advance-battery-cell-production-in-the-United-States.xhtml?oid=52385590> (last accessed October 23, 2023).

<sup>680</sup> Sriram, Akash, Aditya Soni, and Hyunjoo Jin. “Tesla plans \$3.6 bln Nevada expansion to make Semi truck, battery cells.” *Reuters*. January 25, 2023. Last accessed on March 31, 2023 at <https://www.reuters.com/markets/deals/tesla-invest-over-36-bln-nevada-build-two-new-factories-2023-01-24/>.

<sup>681</sup> Sion Power. “Cummins Invests in Sion Power to Develop Licerion® Lithium Metal Battery Technology for Commercial Electric Vehicle Applications”. November 30, 2021. Available online: <https://sionpower.com/2021/cummins-invests-in-sion-power-to-develop-licerion-lithium-metal-battery-technology-for-commercial-electric-vehicle-applications/>.

the DOE has conducted an analysis of public announcements that shows that in 2027–2032, there will be sufficient domestic battery manufacturing capacity for the HD industry to produce cells and modules that meet the requirements of the 45X tax credit and to supply the volumes we project in this final rulemaking.<sup>682</sup> Furthermore, DOE is funding through the BIL battery materials processing and manufacturing projects to “support new and expanded commercial-scale domestic facilities to process lithium, graphite and other battery materials, manufacture components, and demonstrate new approaches, including manufacturing components from recycled materials.”<sup>683</sup>

In the NPRM, we projected that the tax credit earned by battery cell and module manufacturers is passed through to the purchaser because market competition would drive manufacturers to minimize their prices. We received comment on this projection from three commenters, questioning how much of the credit will be passed down from battery cell and module manufacturers through the supply chain to the ultimate purchaser because of the large upfront investments required to build manufacturing plants. In an interview with Axios following Daimler Trucks, Cummins, and PACCAR’s recently announced battery factory,<sup>684</sup> Cummins noted that the 45X tax credit “is expected to benefit customers by

<sup>682</sup> Kevin Knehr, Joseph Kubal, Shabbir Ahmed, “Cost Analysis and Projections for U.S.-Manufactured Automotive Lithium-ion Batteries”, Argonne National Laboratory report ANL/CSE-24/1 for US Department of Energy. January 2024. Available online: <https://www.osti.gov/biblio/2280913>.

<sup>683</sup> U.S. Department of Energy. “Bipartisan Infrastructure Law: Battery Materials Processing and Battery Manufacturing & Recycling Funding Opportunity Announcement—Factsheets”. October 19, 2022. Available online: [https://www.energy.gov/sites/default/files/2022-10/DOE%20BIL%20Battery%20FOA-2678%20Selectee%20Fact%20Sheets%20-%20201\\_2.pdf](https://www.energy.gov/sites/default/files/2022-10/DOE%20BIL%20Battery%20FOA-2678%20Selectee%20Fact%20Sheets%20-%20201_2.pdf).

<sup>684</sup> Daimler Trucks North America. “Accelera by Cummins, Daimler Truck and PACCAR form a joint venture to advance battery cell production in the United States.” September 6, 2023. Available online: <https://media.daimlertruck.com/marsMediaSite/en/instance/ko/Accelera-by-Cummins-Daimler-Truck-and-PACCAR-form-a-joint-venture-to-advance-battery-cell-production-in-the-United-States.xhtml?oid=52385590> (last accessed October 23, 2023).

<sup>676</sup> Inflation Reduction Act of 2022, Pub. L. 117-169, 136 Stat. 1818 (2022) (“Inflation Reduction Act” or “IRA”), available at <https://www.congress.gov/117/bills/hr/5376/BILLS-117hr5376enr.pdf>.

<sup>677</sup> United States, Congress. Public Law 117-58. Infrastructure Investment and Jobs Act of 2021. Congress.gov, [www.congress.gov/bill/117th-congress/house-bill/3684/text](http://www.congress.gov/bill/117th-congress/house-bill/3684/text). 117th Congress, House Resolution 3684, passed 15 November 2021.

lowering the price of batteries.”<sup>685</sup> After consideration of these comments and the literature and announcements described in the previous paragraph, we are continuing to include the tax credits in our assessment of purchaser costs. We maintain our modeling approach for

this tax credit in HD TRUCS such that HD BEV and FCEV manufacturers fully utilize the battery module tax credit and gradually increase their utilization of the cell tax credit for MYs 2027–2029 until MY 2030 and beyond, when they earn 100 percent of the available cell

and module tax credits. The battery pack costs and battery tax credits used in our analysis are shown in Table II–20. Further discussion of these assumptions can be found in RTC section 2.7.

**Table II-20 Pack-Level Battery Direct Manufacturing Costs and IRA Tax Credits in HD TRUCS (2022\$)**

Model Year	2027	2028	2029	2030	2031	2032
Battery Pack Cost (\$/kWh)	120	113	107	103	100	97
IRA Cell Credit (\$/kWh)	8.75	17.50	26.25	26.25	17.50	8.75
IRA Module Credit (\$/kWh)	10.00	10.00	10.00	7.50	5.00	2.50
IRA Total Battery Credit (\$/kWh)	18.75	27.50	36.25	33.75	22.50	11.25

Similar to our approach in using indirect cost multipliers to calculate retail price equivalents, in which we do not attempt to mirror, predict, or otherwise approximate individual companies’ marketing strategies in estimating costs for the modeled potential compliance pathway (see section IV of this preamble), we do not attempt to predict specifically how manufacturers will use the 45X tax credit to alter their products’ prices. Instead, we estimate the costs we expect to be incurred by manufacturers for the modeled potential compliance pathway—including direct manufacturing costs, indirect costs, and tax credits—and calculate the resulting retail price equivalents that would allow manufacturers to fully recover their costs of compliance. Regarding the second of the provisions, IRA section 13403 creates a tax credit under 45W of the Internal Revenue Code applicable to each purchase of a qualified commercial clean vehicle. These vehicles must be on-road vehicles (or mobile machinery) that are propelled to a significant extent by a battery-powered electric motor. The battery must have a capacity of at least 15 kWh (or 7 kWh if it is Class 3 or below) and must be rechargeable from an external source of electricity. This limits the qualified vehicles to BEVs and PHEVs. Additionally, FCEVs are eligible. The credit is available from CY 2023 through 2032, which overlaps with the model years for which we are finalizing standards (MYs 2027 through 2032), so we included the tax credit in

our calculations for each of those years in HD TRUCS.

For BEVs and FCEVs, the tax credit is equal to the lesser of: (A) 30 percent of the BEV or FCEV cost, or (B) the incremental cost of a BEV or FCEV when compared to a comparable ICE vehicle. The limit of this tax credit is \$40,000 for Class 4–8 commercial vehicles and \$7,500 for commercial vehicles Class 3 and below. For example, if a BEV costs \$350,000 and a comparable ICE vehicle costs \$150,000,<sup>686</sup> the tax credit would be the lesser of: (A)  $0.30 \times \$350,000 = \$105,000$  or (B)  $\$350,000 - \$150,000 = \$200,000$ . In this example, (A) is less than (B), but (A) exceeds the limit of \$40,000, so the tax credit would be \$40,000.

We received numerous comments on this 45W tax credit. Many commenters noted the potential for this tax credit to help reduce costs of ZEVs for the purchaser, with commenters differing in their assessment of how competitive the costs of ZEVs would be compared to prices of ICE vehicles after earning the tax credit. For example, one commenter stated that IRA incentives, including the 45W tax credit, would bring total cost of ownership of electric trucks lower than diesel trucks approximately five years sooner than without the law. In contrast, other commenters asserted that the tax credit could easily be offset by Federal excise and state taxes, let alone the increased cost of the ZEV without considering taxes. Additionally, one commenter questioned whether purchasers with limited tax liabilities would be able to leverage the tax credit.

Regarding this last concern that limited tax liabilities would reduce purchaser’s ability to leverage the tax credit, we note that the Internal Revenue Service (IRS) has stated that a 45W credit can be carried over as a general business credit and that unused general business credits may be carried back one year and carried forward to each of the 20 tax years after the year of the credit to help offset prior and future tax liabilities.<sup>687 688</sup> Additionally, for applicable entities who can use elective pay, including tax-exempt organizations, States, and political subdivisions such as local governments, Indian tribal governments, Alaska Native Corporations, the Tennessee Valley Authority, rural electric cooperatives, U.S. territories and their political subdivisions, and agencies and instrumentalities of state, local, tribal, and U.S. territorial governments, the value of the credit can be paid by the IRS to the applicable entity.<sup>689 690</sup> Our inclusion of the Federal excise tax (which imposes a Federal tax liability associated with the purchase of a ZEV), the long credit life as a general business credit, and the elective pay provisions support our application of the credit to all eligible vehicle sales in our analysis.

We maintain our NPRM approach to modeling this tax credit. We included this tax credit in HD TRUCS by decreasing the incremental upfront cost a vehicle purchaser must pay for a ZEV compared to a comparable ICE vehicle following the process explained in the previous two paragraphs. The calculation for this tax credit was done

<sup>685</sup> Geman, Ben. “How Biden’s climate law is fueling the U.S. battery boom.” *Axios*. September 7, 2023. Last accessed on November 2, 2023 at: <https://www.axios.com/2023/09/07/battery-boom-daimler-blackrock>.

<sup>686</sup> Sharpe, B., Basma, H. “A meta-study of purchase costs for zero-emission trucks”. International Council on Clean Transportation. February 17, 2022. Available online: <https://theicct.org/wp-content/uploads/2022/02/purchase-cost-ze-trucks-feb22-1.pdf>.

<sup>687</sup> Internal Revenue Service. “Commercial Clean Vehicle Credit.” February 16, 2024. Last accessed on March 18, 2024. Available at: <https://www.irs.gov/credits-deductions/commercial-clean-vehicle-credit>.

<sup>688</sup> Internal Revenue Service. “Instructions for Form 3800 (2022).” February 8, 2024. Last accessed on March 18, 2024. Available at: <https://www.irs.gov/instructions/i3800>.

<sup>689</sup> Internal Revenue Service. “Elective pay and transferability.” March 5, 2024. Last accessed on March 18, 2024. Available at: <https://www.irs.gov/credits-deductions/elective-pay-and-transferability>.

<sup>690</sup> Internal Revenue Service. “Elective Pay and Transferability Frequently Asked Questions: Elective Pay.” March 11, 2024. Last accessed on March 18, 2024. Available at: <https://www.irs.gov/credits-deductions/elective-pay-and-transferability-frequently-asked-questions-elective-pay#eligibility>.

after applying a retail price equivalent to our direct manufacturing costs. We did not calculate the full cost of vehicles in our analysis; instead, we determined that all Class 4–8 ZEVs could be eligible for the full \$40,000 (or \$7,500 for ZEVs Class 3 and below) if the incremental cost calculated compared to a comparable ICE vehicle was greater than that amount. In order for this determination to be true, all Class 4–8 ZEVs must cost more than \$133,333 such that 30 percent of the cost is at least \$40,000 (or \$25,000 and \$7,500, respectively, for ZEVs Class 3 and below), which seems reasonable based on our assessment of the literature.<sup>691</sup> As in the calculation described in the previous paragraph, both (A) and (B) are greater than the tax credit limit and the vehicle purchaser may receive the full tax credit. The incremental cost of a ZEV taking into account the tax credits for each vehicle segment in MY 2027 and MY 2032 are included in RIA Chapter 2.9.2.

5. Purchaser Costs

Operating costs for HD vehicles encompass a variety of costs, such as labor, insurance, registration fees, fueling, maintenance and repair (M&R), and other costs. For this HD TRUCS analysis, we are primarily interested in costs that are different for a comparable diesel-powered ICE vehicle and for a ZEV.<sup>693</sup> These operational cost

differences are used to calculate an estimated payback period in HD TRUCS. We expect fueling costs and M&R costs to be different for ZEVs than for comparable diesel-fueled ICE vehicles and included these costs in our analysis to support the NPRM. Some commenters pointed out that we should also include insurance cost. For the final rule HD TRUCS analysis, operating costs are calculated each year as a summation of the annual fuel cost, maintenance and repair costs, insurance cost, and additional ZEV registration fee. In addition, for the final rule we considered the cost impact of the Federal excise tax and state sales tax to the operator at the time of purchase after consideration of the comments we received. Each of the following subsections include the costs for ICE vehicles, BEVs, and FCEVs.

i. Maintenance and Repair (M&R) Costs

M&R costs contribute to the overall operating costs for HD vehicles. Data on real-world M&R costs for HD ZEVs is limited due to limited HD ZEV technology adoption today. We expect the overall maintenance costs to be lower for ZEVs compared to a comparable ICE vehicle for several reasons. First, an electric powertrain has fewer moving parts that accrue wear or need regular adjustments. Second, ZEVs do not require fluids such as engine oil or diesel exhaust fluid (DEF), nor do they require exhaust filters to reduce particulate matter or other pollutants. Third, the per-mile rate of brake wear is expected to be lower for ZEVs due to regenerative braking systems. Several literature sources propose applying a scaling factor to diesel vehicle maintenance costs to estimate ZEV maintenance costs.<sup>694</sup>

EPA indicated at proposal that HD ZEVs would experience significant

maintenance and repair savings vis-a-vis their ICE counterparts. This finding was based on these vehicles' simpler design, notably absence of pistons and valves, and fewer moving parts in general.<sup>697</sup> Multiple commenters agreed that ZEV purchasers would experience cost savings due to lower maintenance and repair costs. Other commenters questioned EPA's finding. These commenters maintained that it would take two technicians rather than one to service an HD BEV. In addition, they stated that mechanics will require safety training for ZEV maintenance and repair, and that EPA had failed to account for the associated costs. Another question raised in these comments is whether there are sufficient technicians qualified to service HD ZEVs. Other commenters said that maintenance facility upgrades will be needed in order to service ZEVs and that such upgrades are a cost of the rule.

Several of these commenters went on to challenge the empirical basis for EPA's estimates. In HD TRUCS, ZEV maintenance and repair costs are estimated by first calculating the baseline diesel maintenance and repair costs and then by applying BEV and FCEV downward scaling factors based on Wang, et al.<sup>698</sup> so that cost savings are the product of the diesel maintenance and repair costs times the scaling factor. Several commenters criticized EPA for (purportedly) relying on a single source for the ZEV scaling factors, and further, that the source itself quotes a large range of potential values for those factors. One commenter also noted a multi-year study of light-duty electric vehicles which showed maintenance costs averaging 2.3 times that of ICE vehicles due to the longer maintenance time and lack of qualified technicians.

ZEV vehicles have fewer moving parts than their ICEV counterparts, which is typically indicative of fewer serviceable parts and fewer potential failures. EPA reiterates that this will result in reduced costs for maintenance and repair for their users. This conclusion has ample support. Multiple cost assessment papers and the California Advanced Clean Fleets Regulation Appendix G: Total Cost of Ownership<sup>699</sup> use cost reduction factors for ZEV maintenance

<sup>691</sup> Burnham, A., Gohlke, D., Rush, L., Stephens, T., Zhou, Y., Delucchi, M. A., Birky, A., Hunter, C., Lin, Z., Ou, S., Xie, F., Proctor, C., Wiriyadinata, S., Liu, N., Bolor, M. "Comprehensive Total Cost of Ownership Quantification for Vehicles with Different Size Classes and Powertrains". Argonne National Laboratory. April 1, 2021. Available at <https://publications.anl.gov/anlpubs/2021/05/167399.pdf>.

<sup>692</sup> The Department of Energy published an "Incremental Purchase Cost Methodology and Results for Clean Vehicles" that estimates representative vehicle costs for broad vehicle types relevant to this rulemaking: Class 4–6, Class 7, and Class 8 ICE vehicles, BEVs, PHEVs, and FCEVs. The report indicates that Class 7 and 8 ZEVs cost more than \$133,333, while Class 4–6 ZEVs cost less than \$133,333. While this assessment conflicts with our simplifying assumption for Class 4–6 ZEVs, we note that our Class 4–6 ZEVs' 45W tax credits, as shown in RIA Chapter 2.9.2, are mostly projected to be limited by a wide margin by the incremental costs and not the \$40,000 limit affected by this assumption. The exceptions to this are the recreational vehicles, which we do not project as having significant ZEV adoption due to their lengthy payback periods, even with the full \$40,000 tax credit. Department of Energy, "Incremental Purchase Cost Methodology and Results for Clean Vehicles". December 2023. Available online: <https://www.energy.gov/sites/default/files/2023-12/2023.12.18%20Incremental%20Purchase%20Cost%20Methodology%20and%20Results%20for%20Clean%20Vehicles%20pub%2012-2022%20amd%2012-2023%20Final%20.pdf>.

<sup>693</sup> For diesel-fueled ICE vehicles, we also estimated the cost of the diesel exhaust fluid (DEF)

required for the selective catalytic reduction aftertreatment system. See RIA Chapter 2.3.4.1 for DEF costs.

<sup>694</sup> Burnham, A., Gohlke, D., Rush, L., Stephens, T., Zhou, Y., Delucchi, M. A., Birky, A., Hunter, C., Lin, Z., Ou, S., Xie, F., Proctor, C., Wiriyadinata, S., Liu, N., Bolor, M. "Comprehensive Total Cost of Ownership Quantification for Vehicles with Different Size Classes and Powertrains". Argonne National Laboratory. April 1, 2021. Available online: <https://publications.anl.gov/anlpubs/2021/05/167399.pdf>.

<sup>695</sup> Hunter, Chad, Michael Penev, Evan Reznicek, Jason Lustbader, Alicia Birkby, and Chen Zhang. "Spatial and Temporal Analysis of the Total Cost of Ownership for Class 8 Tractors and Class 4 Parcel Delivery Trucks". National Renewable Energy Lab. September 2021. Available online: <https://www.nrel.gov/docs/fy21osti/71796.pdf>.

<sup>696</sup> Burke, Andrew, Marshall Miller, Anish Sinha, et. al. "Evaluation of the Economics of Battery-Electric and Fuel Cell Trucks and Buses: Methods, Issues, and Results". August 1, 2022. Available online: <https://escholarship.org/uc/item/1g89p8dn>.

<sup>697</sup> 88 FR 25986–87.

<sup>698</sup> Wang, Guihua et al. "Estimating Maintenance and Repair Costs for Battery Electric and Fuel Cell Heavy Duty Trucks". Available online: <https://escholarship.org/uc/item/36c08395>.

<sup>699</sup> <https://ww2.arb.ca.gov/sites/default/files/barcu/regact/2022/acf22/appg.pdf>. See section 4, pages G–21–G–23.

compared to internal combustion engine maintenance.

However, there are considerations of when those savings will accrue. EPA agrees with commenters that there is some uncertainty in predicting cost reductions for maintenance and repair of ZEV heavy-duty vehicles before production and usage become more common. A further uncertainty involves a potential need to retrain technicians to work on ZEVs.

EPA has adjusted its cost estimates to reflect consideration of these uncertainties. We agree that there may be a transition period during which costs for maintaining and repairing ZEVs will not be at their full savings potential due to the need to train more of the workforce to maintain and repair ZEVs. To account for this period, in this final rule HD TRUCS analysis EPA has phased in the ZEV scaling factors for maintenance and repair. Specifically, instead of applying a single scaling factor for every year commencing in 2027 (for BEVs) or 2030 (for FCEVs) as at proposal, EPA is starting with a higher scaling factor and gradually decreasing it (*i.e.*, gradually increasing the projected cost savings) over a 5-year period. The initial higher scaling factor comes from Wang et al. and reflects estimates for 2022. EPA’s approach of applying this factor commencing in 2027 or 2030 is consequently conservative given that technicians in those later years will be more experienced than they were in 2022.

The criticism that EPA used a single source to derive the scaling factors does not paint a full picture of EPA’s selection of these values. EPA examined multiple papers with proposed scaling

factors.<sup>700</sup> We selected the values in the Wang et al. paper because its methodology was supported by a ground-up assessment of the differences in BEV, FCEV and diesel components, and the cost reduction (scaling factor) values in the paper fall within the range of other suggested scaling factor values in the literature.

In this final rule HD TRUCS analysis, EPA has made a further change involving cost estimates for ICE vehicle maintenance and repair costs—the baseline to which the scaling factors are applied for cost estimation purposes—a change not requested in comments but one we think is warranted. In the NPRM analysis, we developed the ICE vehicle M&R costs based on two different equations—one for sleeper cab tractors which travel longer distances and one for vocational vehicles and day cab tractors. The value used for vocational vehicles in the NPRM includes a higher cents per mile value than the one used for sleeper cab tractors. For the final rule analysis, we used the lower cents per mile M&R value for sleeper cabs for all HD vehicles. This change reduced the overall maintenance cost estimates for diesel vehicles, which in turn reduces the overall estimated savings from ZEV M&R for users under the potential compliance pathway that supports the feasibility of the final standards, since the savings values are estimated as a cost reduction from the diesel maintenance and repair values. An explanation for the basis for this change is set out in RTC section 3.6. Lowering the diesel maintenance and repair costs, along with phasing in the ZEV scaling factors, together resulted in

a substantial reduction in estimated ZEV maintenance and repair savings in the final rule compared to the NPRM.

The article cited by one commenter from Kelly Blue Book<sup>701</sup> refers to an analysis of light-duty, not heavy-duty, vehicles.<sup>702</sup> While this article says that a predictive analytics firm, We Predict, found that EVs “cost more to repair than their gasoline engine counterparts”, that article also states that that “EVs cost less in maintenance because they have fewer regular maintenance procedures.” The reason it finds that EVs are more expensive is because technicians are spending more time working on EVs than they are on gasoline cars, and that those technicians cost more per hour. As noted, EPA understands that costs for servicing ZEVs may be more expensive in the very near term than they will be once technicians are retrained and have gained some experience; EPA expects the service technician workforce to transition to a workforce that has the skills and experience needed to service ZEVs. The Kelly Blue Book article supports EPA’s expectation: the article states that We Predict “believes that EVs may prove less expensive in the long run.” The article goes on to quote the We Predict CEO, James Davies, “The cost of keeping the vehicle in service for the EV, even as the EV gets older, becomes smaller and smaller and actually less than keeping an ICE [internal combustion engine] vehicle on the road. . . . That’s not just maintenance costs, but all service costs.”<sup>703</sup>

The M&R BEV scaling factors used to support the final rule analysis are shown in Table II–21.

**Table II-21 Maintenance and Repair Scaling Factor to ICE for BEV and FCEV for CY 2027 - 2035**

	2027	2028	2029	2030	2031	2032	2033	2034	2035
BEV	0.88	0.846	0.812	0.778	0.744	0.71	0.71	0.71	0.71
FCEV	1	1	1	1	0.95	0.9	0.85	0.8	0.75

EPA agrees that when new products are introduced dealers may encounter new costs, such as technician training to repair ZEVs. EPA therefore accounts for these costs in the RPE multipliers. EPA’s heavy-duty retail price equivalent (RPE) mark-up includes a 6 percent markup over manufacturing cost for

Dealer new vehicle selling costs. See section IV.B.2 of this preamble for further discussion.

ii. Fuel, Charging, and Hydrogen Costs

The annual fuel cost for operating a diesel-fueled ICE vehicle is a function of its yearly fuel consumption and the cost

of diesel fuel. The yearly fuel consumption is described in RIA Chapter 2.3.4.3. As we did in the NPRM, we used the DOE Energy Information Administration’s (EIA) Annual Energy Outlook (AEO) transportation sector reference case projection for diesel fuel for on-road use for diesel prices.<sup>704</sup> For

<sup>700</sup> See EPA’s Draft Regulatory Impact Analysis: Greenhouse Gas Emissions for Heavy-Duty Vehicles: Phase 3. EPA–420–D–23–004. April 2023. Page 265 and sources cited in endnotes 93, 94, and 95.

<sup>701</sup> <https://www.kbb.com/car-news/study-evs-cost-more-to-repair-less-to-maintain/>.

<sup>702</sup> Heavy-duty ICE vehicle maintenance and repair may have some correlation with light-duty maintenance and repair, but the comparison does not consider the maintenance and repair costs of diesel engine and exhaust aftertreatment systems which are greater than the costs associated with light-duty vehicles.

<sup>703</sup> <https://www.kbb.com/car-news/study-evs-cost-more-to-repair-less-to-maintain/>.

<sup>704</sup> U.S. Energy Information Administration. Annual Energy Outlook 2023. Table 57 Components of Selected Petroleum Product Prices. Diesel Fuel End User Price. Last accessed on 12/2/2023 at <https://www.eia.gov/outlooks/aeo/data/browser/#/?id=70-AEO2023&cases=ref2023&sourcekey=0>.

the final rule analysis, we updated to the latest version of AEO 2023. These fuel prices include Federal and State taxes but exclude county and local taxes.

We note at the outset HD BEV related power generation and transmission actions and their costs are insignificant when compared to historical levels of total power generation. See section II.D.2.iii of this preamble and RTC section 7 (Distribution). Some commenters agreed that the projected power and transmission needs for HD BEVs is achievable, especially when the gradual increase is recognized. Some other commenters applied different analysis to generate significant power level increases. As discussed in section V, we model changes to power generation due to the increased electricity demand anticipated under the potential compliance pathway in the final rule as part of our upstream analysis. We project the additional generation needed to meet the demand of the heavy-duty BEVs in the final rule to be relatively modest (as shown in RIA Chapter 6.5); the final rule is estimated to increase electric power end use by heavy-duty electric vehicles by 0.1 percent in 2027 and increasing to 2.8 percent in 2055. This is consistent with estimates from the utility industry itself,<sup>705</sup> and from manufacturers.<sup>706</sup> As a comparison, the U.S. electricity end use between the years 1992 and 2021, a similar number of years included in our analysis, increased by around 25 percent<sup>707</sup> without any adverse effects on electric grid reliability or electricity generation capacity shortages. See also RTC section 7.1.

We do agree that there can be costs associated with distribution grid buildout, and with public charging networks associated with BEV HDV charging. EPA agrees with commenters that these costs should be included in our analysis and we have done so in the final rule analysis. We agree with commenters that suggested these costs could be reflected in the cost of fuel *i.e.*, in the charging cost—rather than as capital (upfront) costs. Although there is considerable uncertainty associated with future distribution system upgrades and costs, our final rulemaking analysis, which incorporates findings from TEIS, suggests that the

cost, when spread over the appropriate timeframe and user base, is modest.<sup>708</sup> Utilities will have various mechanisms to recoup their expenditures on grid distribution infrastructure. The process chosen by any given utility may depend on the size and financial resources of the utility or it may be driven by regulatory rules and direction. For the analysis in this final rule, we are including grid infrastructure as recouped through charging costs. Details on electricity distribution system costs and resulting charging costs are provided in this section and in RIA Chapter 2.4.4.2.

The annual charging cost for operating a HD electric vehicle is a function of the electricity price, daily energy consumption of the vehicle, and number of operating days in a year. For the NPRM we used the DOE EIA AEO 2022 reference case commercial electricity end-use rate projection for our electricity price.<sup>709</sup> We received comments that this approach may underestimate charging costs experienced by BEV owners. One commenter noted that we should account for the impact of increased BEV demand on future electricity prices. Several commenters discussed the impact of high demand charges on electricity price. Other commenters noted that there are additional costs that could increase the effective cost to charge including EVSE maintenance costs. Some commenters noted that vehicles using public charging could likely incur higher costs to charge than those at depots.

EPA agrees that our approach in the NPRM underestimated charging costs and we have increased the electricity prices used in HD TRUCS for the final rule analysis. We also agree with commenters that EVSE maintenance costs and distribution upgrade costs due to increased BEV demand should be taken into account, and that incorporating these into the charging costs is a reasonable approach; we have done so in HD TRUCS for the final rule analysis.

For the final rule, in HD TRUCS we differentiate between depot charging

and public charging when assigning charging costs. As explained, we have also expanded the scope of what is covered in these costs to better reflect the cost of charging. The charging costs we use for both charging types include the cost of electricity as charged by the utility (\$/kWh) as well as additional costs for EVSE maintenance and distribution upgrades (expressed in \$/kWh) when those upgrades are needed. Our public charging price additionally includes amortized cost of public charging equipment and land costs for the station;<sup>710</sup> and we project that third parties may install and operate these stations and pass costs onto BEV owners via charging costs.

To estimate charging costs, we start by modeling future electricity prices, as charged by utilities, that account for the costs of BEV charging demand and the associated distribution system upgrade costs. We do this in three steps: (1) we model future power generation using the Integrated Planning Model (IPM), (2) we estimate the cost of distribution system upgrades associated with charging demand through the DOE Multi-State Transportation Electrification Impact Study (TEIS),<sup>711</sup> and (3) we use the Retail Price Model to project electricity prices accounting for both (1) and (2).

As described in RIA Chapter 4.2, IPM models the power sector, including changes to power generation based on future demand scenarios. In order to capture the potential future impacts on the power sector from zero-emission vehicles, we ran IPM for a scenario that combined electricity demand from an interim version of the final standards case and EPA's proposed rulemaking "Multi-Pollutant Emissions Standards for Model Years 2027 and Later Light-Duty and Medium-Duty Vehicles."<sup>712</sup> The same demand scenario was used as the action case for the TEIS.<sup>713</sup> The TEIS

<sup>710</sup> As discussed in section II.E.2, capital costs for EVSE used in depot charging are accounted for separately. We make the simplifying assumption that fleets will utilize existing parking depots when installing EVSE and therefore will not incur additional costs for purchasing or leasing land.

<sup>711</sup> See preamble section II.D.2.c.iii and RTC section 7 (Distribution) for a fuller description of the TEIS.

<sup>712</sup> Electricity demand for heavy-duty ZEVs was based on the interim control case described in RIA Chapter 4.2.4 and for light- and medium-duty vehicles was based on Alternative 3 from EPA's proposed "Multipollutant Emissions Standards for Model Years 2027 and Later Light-Duty and Medium-Duty Vehicles" (88 FR 29184 *et seq.*). See the TEIS report for more information on the modeled ('Action') scenario with managed charging, and how demand was allocated by region and time of day.

<sup>713</sup> National Renewable Energy Laboratory, Lawrence Berkeley National Laboratory, Kevala

<sup>705</sup> Comments of Edison Electric Institute, additionally summarized and discussed in RTC section 7 (Distribution) and 7.1.

<sup>706</sup> See, *e.g.*, Comments of DTNA, EPA-HQ-OAR-2022-0985, pp. 52–53.

<sup>707</sup> Annual Energy Outlook 2022, U.S. Energy Information Administration, March 3, 2022 (<https://www.eia.gov/outlooks/aeo/narrative/introduction/sub-topic-01.php>).

<sup>708</sup> National Renewable Energy Laboratory, Lawrence Berkeley National Laboratory, Kevala Inc., and U.S. Department of Energy. "Multi-State Transportation Electrification Impact Study: Preparing the Grid for Light-, Medium-, and Heavy-Duty Electric Vehicles". DOE/EE-2818. U.S. Department of Energy. March 2024.

<sup>709</sup> U.S. Department of Energy, Energy Information Administration. Annual Energy Outlook 2023, Table 8: Electricity Supply, Disposition, Prices, and Emissions. Last accessed on 10/30/2023. Available online: <https://www.eia.gov/outlooks/aeo/data/browser/#/?id=8-AEO2023&cases=ref2023&sourcekey=0>.

research team modeled how many new or upgraded substations, feeders, and transformers would be needed to meet projected electricity demand, including demand from residential workplace, depot, and public charging to support projected light-, medium-, and heavy-duty plug-in electric vehicles. For all public and workplace charging, vehicles were assumed to charge upon arrival at full power. At homes and depot charging stations—where vehicles have longer dwell times—a managed charging scenario was developed to spread out charging and reduce peak power. (See RIA Chapter 1.6.5 and RTC section 7 (Distribution) for a discussion of the potential benefits of managed charging to fleet owners.)

The changes to power generation in our modeled IPM scenario and the distribution cost estimates from TEIS were then input to the Retail Price

Model (RPM).<sup>714</sup> The RPM developed by ICF generates estimates for average electricity prices across consumer classes accounting for the regional distribution of electricity demand. The resulting national average retail prices, which include distribution upgrade costs, were used as a basis for the charging costs in HD TRUCS.<sup>715</sup>

For depot charging, we add 0.52 cents/kWh to the RPM results to account for EVSE maintenance costs. These values are from a recent ICCT study,<sup>716</sup> which was suggested in public comments (see RTC Chapter 6).<sup>717</sup> For public charging, we project an electricity price of 19.6 cents/kWh for 2027 and adjust it for future years according to the results of the IPM Retail Price Model discussed. The initial value from the same ICCT study<sup>718</sup> reflects costs for public charging at stations designed for long-haul vehicles.

Stations are assumed to have seventeen 1 MW EVSE ports and twenty 150 kW EVSE ports for a total peak power capacity of 20 MW. The 19.6 cent/kWh price includes the amortized cost of this charging equipment, land costs, both electricity prices (cents/kWh) and demand charges (cents/kW) associated with high peak power, distribution upgrade costs for substations, feeders, and transformers associated with these public charging stations, and EVSE maintenance costs. We apply public electricity prices to long-haul vehicles, some longer-range day cab tractors and coach buses (see section II.D.5.i of this preamble). Overall, our charging costs used in the final rule analysis are higher than those used in the NPRM analysis, particularly since those costs now reflect maintenance, grid distribution upgrades, and public charging costs.

**Table II-22 Charging Costs (2022\$)**

CY	Depot (cents/kWh)	Public (cents/kWh)
2027	12.36	19.60
2028	12.36	19.60
2029	12.09	19.33
2030	11.83	19.07
2031	11.81	19.05
2032	11.79	19.03
2033	11.77	19.02
2034	11.76	19.00
2035	11.74	18.98
2036	11.72	18.97
2037	11.71	18.95
2038	11.70	18.94
2039	11.68	18.92
2040	11.67	18.91
2041	11.61	18.85

For the HD TRUCS analysis, rather than focusing on depot hydrogen fueling infrastructure costs that would be incurred upfront, we included infrastructure costs in our per-kilogram retail price of hydrogen. The retail price of hydrogen is the total price of hydrogen when it becomes available to the end user, including the costs of production, distribution, storage, and

dispensing at a fueling station. This price per kilogram of hydrogen includes the amortization of the station capital costs. This approach is consistent with the method we use in HD TRUCS for ICE vehicles, where the equivalent diesel fuel costs are included in the diesel fuel price instead of accounting for the costs of fuel stations separately, as well as for BEVS with public

charging, as explained previously in this section.

We acknowledge that this market is still emerging and that hydrogen fuel providers will likely pursue a diverse range of business models. For example, some businesses may sell hydrogen to fleets through a negotiated contract rather than at a flat market rate on a given day. Others may offer to absorb

Inc., and U.S. Department of Energy. “Multi-State Transportation Electrification Impact Study: Preparing the Grid for Light-, Medium-, and Heavy-Duty Electric Vehicles”. DOE/EE-2818. U.S. Department of Energy. March 2024.

<sup>714</sup> ICF. “Documentation of the Retail Price Model. Draft.” 2019. Available online: [https://www.epa.gov/sites/default/files/2019-06/documents/rpm\\_documentation\\_june2019.pdf](https://www.epa.gov/sites/default/files/2019-06/documents/rpm_documentation_june2019.pdf).

<sup>715</sup> IPM and the RPM were run for select years. We used linear interpolation for electricity prices

between model run years from 2028–2050. We kept electricity prices constant for 2050+ and assumed the 2027 price was the same as 2028.

<sup>716</sup> Hussein Basma, Claire Buysee, Yuanrong Zhou, and Felipe Rodriguez. “Total Cost of Ownership of Alternative Powertrain Technologies for Class 8 Long-haul Trucks in the United States.” International Council on Clean Transportation. April 2023. Available at: <https://theicct.org/wp-content/uploads/2023/04/tco-alt-powertrain-long-haul-trucks-us-apr23.pdf>.

<sup>717</sup> See Comments of EMA at 28.

<sup>718</sup> Hussein Basma, Claire Buysee, Yuanrong Zhou, and Felipe Rodriguez. “Total Cost of Ownership of Alternative Powertrain Technologies for Class 8 Long-haul Trucks in the United States.” International Council on Clean Transportation. April 2023. Available at: <https://theicct.org/wp-content/uploads/2023/04/tco-alt-powertrain-long-haul-trucks-us-apr23.pdf>.



the infrastructure development risk for the consumer, in exchange for the ability to sell excess hydrogen to other customers and more quickly amortize the cost of building a fueling station. FCEV manufacturers may offer a “turnkey” solution to fleets, where they provide a vehicle with fuel as a package deal. This level of granularity is not reflected in our hydrogen price estimates presented in the RIA.

As discussed in section II.D.3.iv, large Federal incentives are in place that could impact the price of hydrogen. In June 2021, DOE launched a Hydrogen Shot goal to reduce the cost of clean hydrogen production by 80 percent to \$1 per kilogram in one decade.<sup>719</sup> The BIL and IRA included funding for several hydrogen programs to accelerate progress towards the Hydrogen Shot and jumpstart the hydrogen market in the U.S.

For the NPRM analysis, we included a hydrogen price based on analysis from ANL using BEAN. 88 FR 25988. One commenter highlighted several reports that indicate large potential for the hydrogen price to rapidly drop, particularly on the production side. Several commenters expressed concern about the hydrogen price assumption in the NPRM or said that prices cannot be predicted at this time and urged that EPA’s projection be regularly evaluated as the market develops. Some commenters referred to an ICCT analysis of hydrogen pricing that indicated a lack of cost-competitiveness for hydrogen-fueled trucks before 2035. Another commenter noted that the price of \$4 to \$5 per kg (that EPA referenced) is described by DOE as a “willingness to pay” that reflects the total price at which hydrogen must be available to the HD vehicle end user for uptake to occur, or the point at which FCEVs could reach cost parity with diesel vehicles. They stated that it cannot represent the real market and offered a bottom-up analysis to understand what fleet owners would pay at the hydrogen refueling stations. See RTC section 8.2 for the comments submitted on this issue and RIA Chapter 2.5.3.1 for a detailed response and additional discussion about hydrogen price.

For the final rule HD TRUCS analysis, in consideration of the comments, we re-evaluated our assumption about the retail price of hydrogen, in consultation with DOE. We determined the hydrogen price based on several 2030 cost scenarios for hydrogen from the

Pathways to Commercial Liftoff report<sup>720</sup> that are in line with estimates from a previous DOE analysis of market uptake of FCEVs.<sup>721</sup> Several cost trajectories in the report identified paths for around \$6 per kg in 2030, depending on the method of hydrogen production and cost of the station. For 2030, we looked at the average of the sums of low and high pathway estimates for hydrogen produced using steam methane reforming (SMR) with carbon capture and sequestration (CCS) and water electrolysis is just under \$6 per kg in 2030, considering varying incentives from the IRA hydrogen production tax credit (PTC). Distribution, storage, and dispensing costs are based on DOE estimates if advances in distribution and storage technology are commercialized and at scale. Our scenario selections presume that in the near-term, delivery of hydrogen in liquid form is likely, due to the limited capacity of gaseous trailers and limited availability of pipelines.<sup>722</sup> Cost reductions to \$4 per kg are considered feasible by 2035 with next generation fuel dispensing technologies, reductions in the cost of hydrogen production due to IRA incentives, and possibly the use of pipelines for hydrogen delivery.<sup>723</sup>

To evaluate these estimates further, and in response to comments, the National Renewable Energy Lab (NREL) conducted a bottom-up analysis that explores the potential range of levelized costs of dispensed hydrogen (LCOH)<sup>724</sup> from hydrogen refueling stations for HD FCEVs in 2030. Bracci et al.<sup>725</sup> evaluates breakeven costs along the full

supply chain from hydrogen production to dispensing, including station costs by technology component and delivery costs by distance delivered. The authors vary hydrogen delivery distances, station sizes, station utilization rates, and economies of scale. They assume that hydrogen is dispensed in pressurized gaseous form at 700 bars of pressure and is either delivered via liquid tanker trucks or produced onsite in gaseous form. The assumed production cost of \$1.50 per kg is based on costs of production today using steam methane reforming (SMR), though the paper acknowledges that many factors are at play that could impact the cost and method of hydrogen production in 2030 such as the rate of economies of scale; the impacts of policy incentives (e.g., the 45V tax credit);<sup>726</sup> and the success of research, development, and deployment efforts. Most capital and operating costs are derived from Argonne National Laboratory’s Hydrogen Delivery Scenario Analysis Model (HDSAM) Version 4.5.<sup>727</sup>

The authors conclude that the overall system LCOH in 2030 is estimated to range from about \$3.80 per kg-H<sub>2</sub> to \$12.60 per kg-H<sub>2</sub>, depending on the size of stations and method of hydrogen supply.<sup>728</sup> This cost range is not the same as a retail price, but we assume that any retail markup at the station is minimal.<sup>729</sup> Importantly, it does not consider any tax incentives or other state or Federal incentive policies that may further reduce the retail price that consumers see at a fueling station in

<sup>720</sup> U.S. Department of Energy. “Pathways to Commercial Liftoff: Clean Hydrogen”. March 2023. Available online: <https://liftoff.energy.gov/wp-content/uploads/2023/05/20230523-Pathways-to-Commercial-Liftoff-Clean-Hydrogen.pdf>. See Figure 10.

<sup>721</sup> Ledna, et al. “Decarbonizing Medium- & Heavy-Duty On-Road Vehicles: Zero-Emission Vehicles Cost Analysis”. National Renewable Energy Laboratory. March 2022. Available online: <https://www.nrel.gov/docs/fy22osti/82081.pdf>.

<sup>722</sup> U.S. Department of Energy. “Pathways to Commercial Liftoff: Clean Hydrogen”. March 2023. Available online: <https://liftoff.energy.gov/wp-content/uploads/2023/05/20230523-Pathways-to-Commercial-Liftoff-Clean-Hydrogen.pdf>. See Figure 10.

<sup>723</sup> Ledna, et al. “Decarbonizing Medium- & Heavy-Duty On-Road Vehicles: Zero-Emission Vehicles Cost Analysis”. National Renewable Energy Laboratory. March 2022. Available online: <https://www.nrel.gov/docs/fy22osti/82081.pdf>.

<sup>724</sup> LCOH is described as the total annualized capital costs plus annual feedstock, variable, and fixed operating costs, divided by the annual hydrogen flow through the supply chain.

<sup>725</sup> Bracci, Justin, Mariya Koleva, and Mark Chung. “Levelized Cost of Dispensed Hydrogen for Heavy-Duty Vehicles”. National Renewable Energy Laboratory. NREL/TP-5400-88818. March 2024. Available online: <https://www.nrel.gov/docs/fy24osti/88818.pdf>.

<sup>726</sup> The authors indicate that relevant incentives include but are not limited to the Alternative Fuel Refueling Property Credit (30C), the Credit of Production of Clean Hydrogen (45V), the Qualified Advanced Energy Project Credit (48C), and the Credit for Qualified Commercial Clean Vehicles (45W).

<sup>727</sup> Bracci, Justin, Mariya Koleva, and Mark Chung. “Levelized Cost of Dispensed Hydrogen for Heavy-Duty Vehicles”. National Renewable Energy Laboratory. NREL/TP-5400-88818. March 2024. Available online: <https://www.nrel.gov/docs/fy24osti/88818.pdf>.

<sup>728</sup> Bracci, Justin, Mariya Koleva, and Mark Chung. “Levelized Cost of Dispensed Hydrogen for Heavy-Duty Vehicles”. National Renewable Energy Laboratory. NREL/TP-5400-88818. March 2024. Available online: <https://www.nrel.gov/docs/fy24osti/88818.pdf>.

<sup>729</sup> West Virginia Oil Marketers and Grocers Association. “How Much Money Do Businesses Make on Fuel Purchases?” Available online: <https://www.omegawv.com/faq/140-how-much-money-do-businesses-make-on-fuel-purchases.html>.

<sup>730</sup> Kinnier, Alex. “I’ve analyzed the profit margins of 30,000 gas stations. Here’s the proof fuel retailers are not to blame for high gas prices”. Fortune. August 9, 2022. Available online: <https://fortune.com/2022/08/09/energy-profit-margins-gas-stations-proof-fuel-retailers-high-gas-prices-alex-kinnier/>.

<sup>719</sup> U.S. Department of Energy, Hydrogen and Fuel Cell Technologies Office. “Hydrogen Shot”. Available online: <https://www.energy.gov/eere/fuelcells/hydrogen-shot>.

2030.<sup>731</sup> <sup>732</sup> Therefore, we conclude that our retail price of hydrogen of \$6 per kg in 2030, dropping to \$4 per kg by 2035,

is within a reasonable range of anticipated values.

See RIA Chapter 2.5.3.1 for additional detail about our assessment. After consideration of comments and this

assessment, we project the retail price of hydrogen in 2030 will be \$6 per kg and fall to \$4 per kg in 2035 and beyond, as shown in Table II–23.

**Table II-23 Price of Hydrogen for CYs 2030-2035+ (2022\$)**

	2030	2031	2032	2033	2034	2035 and beyond
\$/kg H2	6.00	5.60	5.20	4.80	4.40	4.00

iii. Insurance

In the NPRM analysis, we did not take into account the cost of insurance on the ZEV purchaser. A few commenters suggested we should consider the addition of insurance cost because the incremental cost of insurance for the ZEVs will be higher than for ICE vehicles. We agree that insurance costs may differ between these vehicle types and that this is a cost that will be seen by the operator. Therefore, for the final rule analysis in HD TRUCS, we included the incremental insurance costs of a ZEV relative to an ICEV by incorporating an annual insurance cost equal to 3 percent of initial upfront vehicle technology RPE cost.<sup>733</sup> This annual cost was applied for each operating year of the vehicle. For further discussion on insurance cost see RIA Chapter 2.5.3.3.

iv. Taxes

In the NPRM analysis, we did not account for the upfront taxes paid by the purchaser of the vehicle. Commenters pointed out the additional costs from the Federal excise tax and state sales tax which should be included. For the final rule, we added FET and state sales tax as a part of the upfront cost calculation for purchaser in HD TRUCS. A FET of 12 percent was applied to the upfront powertrain technology retail price equivalent of Class 8 heavy-duty vehicles and all tractors in HD TRUCS (*i.e.*, where the FET is applicable). Similarly, our analysis in HD TRUCS now includes a state sales tax of 5.02 percent, the average sales tax in the U.S. for heavy-duty vehicles. We applied this increase to the upfront powertrain technology retail price equivalent for all vehicles in HD TRUCS.

v. ZEV Registration Fee

In the NPRM analysis, we did not account for ZEV registration fees paid by the purchaser. Commenters have pointed out that some states have adopted state ZEV registration fees. Though 18 states do not have an additional registration fee for ZEVs, for those that do, the registration fees are generally between \$50 and \$225 per year. While EPA cannot predict whether and to what extent other states will enact ZEV registration fees, we have nonetheless conservatively added an annual registration fee of \$100 to all ZEV vehicles in our final HD TRUCS analysis (see RIA Chapter 2.4.4).

6. Payback

After assessing the suitability of the technology and costs associated with ZEVs, EPA performed a payback calculation on each of the 101 HD TRUCS vehicles for the BEV technology and FCEV technology that we considered for the technology packages to support the feasibility of the final standards in the MY 2027–2032 timeframe. The payback period was calculated by determining the number of years that it would take for the annual operational savings of a ZEV to offset the incremental upfront purchase price of a BEV or FCEV (after accounting for the IRA section 13502 battery tax credit and IRA section 13403 vehicle tax credit as described in RIA Chapters 2.4.3.1 and 2.4.3.5, respectively, Federal excise and state sales taxes and charging infrastructure costs (for BEVs, after accounting for the IRA section 13404 Alternative Fuel Refueling Property Credit) when compared to purchasing a comparable ICE vehicle. The ICE vehicle and ZEV costs calculated include the RPE multiplier of 1.42 to include both

direct and indirect manufacturing costs, as discussed further in RIA Chapter 3. The operating costs include the diesel, hydrogen or electricity costs, DEF costs, the maintenance and repair costs, insurance costs, and ZEV registration fee. The payback results for BEVs and FCEVs are shown in RIA Chapter 2.9.2.

In our payback analysis in HD TRUCS, we did not account for potential diesel engine rebuild costs for ICE vehicles, potential replacement battery costs for BEVs or EVSE replacement costs for depot-charged BEVs, or potential replacement fuel cell stack costs for FCEVs because our payback analysis covers a shorter period of time than the expected life of these components. However, we did account for these costs in our program costs, as discussed in RIA Chapter 3.4, because they will occur over the lifetime of the vehicles.

According to a 2013 study conducted by McKay and Co. the average out frame rebuilds for internal combustion engines in Class 4 through 8 vehicles range from 10 to 16 years.<sup>734</sup> In addition, in the HD2027 low NOx rule, EPA increased emissions warranties for MY 2027 and later HD engines beyond what is required today.<sup>735</sup>

Typical battery warranties being offered by HD BEV manufacturers range between 8 and 15 years today and we are finalizing an emissions warranty requirement for HD BEV (see preamble section III.B).<sup>736</sup> A BEV battery replacement may be practically necessary over the operational life of a vehicle if the battery deteriorates to a point where the vehicle range no longer meets the vehicle’s operational needs. As explained in section II.D.5, we sized the battery in BEVs in HD TRUCS to meet a 10 year and 2,000 cycle

<sup>731</sup> The authors indicate that relevant incentives include but are not limited to the Alternative Fuel Refueling Property Credit (30C), the Credit of Production of Clean Hydrogen (45V), the Qualified Advanced Energy Project Credit (48C), and the Credit for Qualified Commercial Clean Vehicles (45W).

<sup>732</sup> U.S. Department of Energy, Hydrogen and Fuel Cell Technologies Office. “Financial Incentives for Hydrogen and Fuel Cell Projects”. Available online: <https://www.energy.gov/eere/>

[fuelcells/financial-incentives-hydrogen-and-fuel-cell-projects](https://www.energy.gov/eere/fuelcells/financial-incentives-hydrogen-and-fuel-cell-projects).

<sup>733</sup> Hussein Basma, Claire Buysee, Yuanrong Zhou, and Felipe Rodriguez, “Total Cost of Ownership of Alternative Powertrain Technologies for Class 8 Long-haul Trucks in the United States,” April 2023. Page 17. Available at: <https://theicet.org/wp-content/uploads/2023/04/tco-alt-powertrain-long-haul-trucks-us-apr23.pdf>.

<sup>734</sup> MacKay & Company “Industry Characterization of Heavy-Duty Diesel Engine

Rebuilds”, September 2013. EPA Contract No. EP–C–12–011 Work Assignment No. 1–06.

<sup>735</sup> HD2027 rule (88 FR 4296, January 24, 2023).

<sup>736</sup> Type C BEV school bus battery warranty range five to fifteen years according to [https://www.nyapt.org/resources/Documents/WRI\\_ESB-Buyers-Guide\\_US-Market\\_2022.pdf](https://www.nyapt.org/resources/Documents/WRI_ESB-Buyers-Guide_US-Market_2022.pdf). The Freightliner electric walk-in van includes an eight-year battery warranty according to <https://www.electricwalkinvan.com/wp-content/uploads/2022/05/MT50e-specifications-2022.pdf>.

threshold to better ensure a battery replacement would not be needed during the payback period assessed in HD TRUCS. Furthermore, we believe that proper vehicle and battery maintenance and management can extend battery life. For example, manufacturers will utilize battery management system to maintain the temperature of the battery<sup>737</sup> as well as active battery balancing to extend the life of the battery.<sup>738 739</sup> Likewise, preconditioning has also shown to extend the life of the battery.<sup>740</sup> In addition, research suggests that battery life is expected to improve with new batteries over time as battery chemistry and battery charging strategies improve, such that newer MY BEVs will have longer battery life.

Similar to the approach we took for sizing the battery in BEVs, we oversized the fuel stack system to extend the

durability of the system, as discussed in section II.D.5.v.

*F. Final Standards*

The final standards are shown in Table II–24 and Table II–25 for vocational vehicles and in Table II–26 and Table II–27 for tractors. We are finalizing CO<sub>2</sub> emission standards for heavy-duty vehicles that, compared to the proposed standards, include less stringent standards for all vehicle categories in MYs 2027, 2028, 2029 and 2030. The final standards increase in stringency at a slower pace through MYs 2027 to 2030 compared to the proposal, and day cab tractor standards start in MY 2028 and heavy heavy-duty vocational vehicles start in MY 2029 (we proposed Phase 3 standards for day cabs and heavy-heavy vocational vehicles starting in MY 2027). As proposed, the final standards for sleeper cabs start in MY 2030 but are less stringent than proposed in that year and in MY 2031, and equivalent to the proposed standards in MY 2032. We are finalizing MY 2031 standards that are on par with the proposal for light- and medium-duty vocational vehicles and day cab tractors. Heavy heavy-duty vocational vehicle final standards are less stringent than proposed for all model years, including 2031 and 2032. For MY 2032, we are finalizing more stringent standards than proposed for light and medium heavy-duty vocational vehicles and day cab tractors.

As further explained in section II.G, and consistent with our HD GHG Phase 1 and Phase 2 rulemakings, in this Phase 3 final rule we considered the following factors: the impacts of potential standards on emissions reductions of GHG emissions; technical feasibility and technology effectiveness;

the lead time necessary to implement the technologies; costs to manufacturers; costs to purchasers including operating savings; the impacts of standards on oil conservation and energy security; impacts of standards on the truck industry; other energy impacts; as well as other relevant factors such as impacts on safety.<sup>741</sup> In this rulemaking, EPA has accounted for a wide range of emissions control technologies, including advanced ICE engine and vehicle technologies (e.g., engine, transmission, drivetrain, aerodynamics, tire rolling resistance improvements, the use of low carbon fuels like CNG and LNG, and H<sub>2</sub>–ICE), hybrid technologies (e.g., HEV and PHEV), and ZEV technologies (e.g., BEV and FCEV). These include technologies applied to motor vehicles with ICE (including hybrid powertrains) and without ICE, and a range of electrification across the technologies (from fully-electrified vehicle technologies without an ICE that achieve zero vehicle tailpipe emissions (e.g., BEVs), fuel cell electric vehicle technologies that run on hydrogen and achieve zero tailpipe emissions (e.g., FCEVs), as well as plug-in hybrid partially electrified technologies and ICEs with electrified accessories). As noted, under these performance-based emissions standards, manufacturers remain free to utilize any compliance choices they wish so long as they meet the CO<sub>2</sub> emissions standards. See section II.G.5 of this preamble for further discussion of how we balanced the factors we considered for the final Phase 3 standards.

<sup>736</sup> Type C BEV school bus battery warranty range five to fifteen years according to [https://www.nyapt.org/resources/Documents/WRI\\_ESB-Buyers-Guide\\_US-Market\\_2022.pdf](https://www.nyapt.org/resources/Documents/WRI_ESB-Buyers-Guide_US-Market_2022.pdf). The Freightliner electric walk-in van includes an eight-year battery warranty according to <https://www.electricwalkinvan.com/wp-content/uploads/2022/05/MT50e-specifications-2022.pdf>.

<sup>737</sup> Basma, Hussein, Charbel Mansour, Marc Haddad, Maroun Nemer, Pascal Stabat. “Comprehensive energy modeling methodology for battery electric buses”. *Energy*: Volume 207, 15 September 2020, 118241. Available online: <https://www.sciencedirect.com/science/article/pii/S0360544220313487>.

<sup>738</sup> Bae, SH., Park, J.W., Lee, S.H. “Optimal SOC Reference Based Active Cell Balancing on a Common Energy Bus of Battery” Available online: <http://koreascience.or.kr/article/JAKO201709641401357.pdf>.

<sup>739</sup> Azad, F.S., Ahasan Habib, A.K.M., Rahman, A., Ahmed I. “Active cell balancing of Li-Ion batteries using single capacitor and single LC series resonant circuit.” <https://beei.org/index.php/EEI/article/viewFile/1944/1491>.

<sup>740</sup> “How to Improve EV Battery Performance in Cold Weather” Accessed on March 31, 2023. <https://www.worktruckonline.com/10176367/how-to-improve-ev-battery-performance-in-cold-weather>.

**Table II-24 Final MY 2027 through 2032+ Vocational Vehicle CO<sub>2</sub> Emission Standards (grams/ton-mile)**

Model Year	Subcategory	CI Light Heavy	CI Medium Heavy	CI Heavy Heavy	SI Light Heavy	SI Medium Heavy
2027	Urban	305	224	269	351	263
	Multi-Purpose	274	204	230	316	237
	Regional	242	190	189	270	219
2028	Urban	286	217	269	332	256
	Multi-Purpose	257	197	230	299	230
	Regional	227	183	189	255	212
2029	Urban	268	209	234	314	248
	Multi-Purpose	241	190	200	283	223
	Regional	212	177	164	240	206
2030	Urban	250	201	229	296	240
	Multi-Purpose	224	183	196	266	216
	Regional	198	170	161	226	199
2031	Urban	198	178	207	244	217
	Multi-Purpose	178	162	177	220	195
	Regional	157	150	146	185	179
2032 and later	Urban	147	155	188	193	194
	Multi-Purpose	132	141	161	174	174
	Regional	116	131	132	144	160

**Table II-25 Final MY 2027 through 2032+ Optional Custom Chassis Vocational Vehicle CO<sub>2</sub> Emission Standards (grams/ton-mile)**

Optional Custom Chassis Vehicle Category	MY 2027	MY 2028	MY 2029	MY 2030	MY 2031	MY 2032 and later
School Bus	236	228	220	211	187	163
Other Bus	286	286	249	243	220	200
Coach Bus	205	205	205	205	205	205
Refuse Hauler	298	283	268	253	250	250
Concrete Mixer	316	316	316	316	316	316
Motor home	226	226	226	226	226	226
Mixed-use vehicle	316	316	316	316	316	316
Emergency vehicle	319	319	319	319	319	319

**Table II-26 Final MY 2027 through MY 2032+ Tractor CO<sub>2</sub> Emission Standards (grams/ton-mile)**

Model Year	Roof Height	Class 7 All Cab Styles	Class 8 Day Cab	Class 8 Sleeper Cab
2027	Low Roof	96.2	73.4	64.1
	Mid Roof	103.4	78.0	69.6
	High Roof	100.0	75.7	64.3
2028	Low Roof	88.5	67.5	64.1
	Mid Roof	95.1	71.8	69.6
	High Roof	92.0	69.6	64.3
2029	Low Roof	84.7	64.6	64.1
	Mid Roof	91.0	68.6	69.6
	High Roof	88.0	66.6	64.3
2030	Low Roof	80.8	61.7	60.3
	Mid Roof	86.9	65.5	65.4
	High Roof	84.0	63.6	60.4
2031	Low Roof	69.3	52.8	56.4
	Mid Roof	74.4	56.2	61.2
	High Roof	72.0	54.5	56.6
2032 and later	Low Roof	57.7	44.0	48.1
	Mid Roof	62.0	46.8	52.2
	High Roof	60.0	45.4	48.2

**Table II-27 Final MY 2027 through MY 2032+ Heavy-Haul Tractor CO<sub>2</sub> Emission Standards (grams/ton-mile)**

Model Year	CO <sub>2</sub> Emission Standards (grams/ton-mile)
2027	48.3
2028	48.3
2029	47.8
2030	47.8
2031	46.9
2032 and later	45.9

Similar to the approach we used to support the feasibility of previous HD rulemakings, including both of the HD GHG rules, to support the feasibility of the final Phase 3 standards we developed projected technology packages for a potential compliance pathway that, on average, will meet each of the final Phase 3 standards for each regulatory subcategory of vocational vehicles and tractors after considering the various factors described in this section, including technology costs for manufacturers and costs to purchasers and operators. The final Phase 3 GHG vehicle standards apply to nationwide production volumes, which we took into account in these technology packages and the potential compliance pathway to support the feasibility of the final Phase 3 GHG vehicle standards. Consistent with EPA’s prior approach for HD GHG vehicle emission standards, the technology packages utilize the averaging portion of the longstanding

ABT program,<sup>742</sup> and our projected potential compliance pathway includes manufacturers producing a mix of HD vehicles that utilize ICE-powered vehicle technologies and ZEV technologies, with specific adoption rates for each regulatory subcategory of vocational vehicles and tractors for each MY based on the analyses described in this section II and RIA Chapter 2. Note that we have analyzed a modeled potential technology compliance pathway to support the feasibility and appropriateness of the level of stringency for each of the final standards and as part of the rulemaking process. EPA’s analysis and modeling provides information about one potential compliance pathway

<sup>742</sup> Note that our modeled potential compliance pathway does not include direct consideration of certain additional flexibilities afforded within the ABT program generally or certain flexibilities specifically updated in this final rule, including carryover of credits generated through Phase 2 multipliers for advanced technologies (see section III.A.2 of this preamble) and an interim transitional effective expansion of averaging sets for credits generated as specified in section III.A.3 of this preamble.

manufacturers could use to comply with the standards. EPA’s analysis projects that both within the product lines of individual manufacturers and for different manufacturers across the industry, manufacturers will make use of a diverse range of technologies, including a projected mix of ICE vehicle, BEV, and FCEV technologies. EPA recognizes that, although it has modeled this potential compliance pathway to support the feasibility of the final rule and as part of the rulemaking process, manufacturers will make their own assessment of the vehicle market and their own decisions about which technologies to apply to which vehicles for any given model year to comply. The standards are performance-based and while EPA finds modeling useful in evaluating the feasibility of the standards, it is manufacturers who will decide the ultimate mix of vehicle technologies to offer. Although EPA cannot analyze every possible compliance scenario, for the analysis for the final standards, we also have evaluated additional example compliance scenarios (*i.e.*, additional

example potential compliance pathways) with only ICE and ICE vehicle technologies, as described in section II.F.3. For example, EPA finds that it would be technologically feasible in the lead time provided and taking into consideration costs to manufacturers and purchasers to meet these final standards without producing additional ZEVs to comply with this rule. The fact that such a fleet is possible underscores both the feasibility and the flexibility of the performance-based standards, and confirms that manufacturers are likely to continue to offer vehicles with a diverse range of technologies, including advanced vehicle with ICE technologies as well as ZEVs for the duration of these standards and beyond. All of these compliance pathways are technically feasible, but in our analysis, the modeled potential compliance pathway is the lowest cost one overall and is the one modeled because EPA assumes that manufacturers are commercial entities that seek to minimize costs and maximize profits.

We phased in the final standards gradually between MYs 2027 and 2032 to address potential lead time concerns associated with feasibility for manufacturers to deploy technologies, including ZEV technologies, to meet the standards. Concerns include consideration of time necessary to ramp up battery production, increase the availability of critical raw minerals and assure sufficiently resilient supply chains, as discussed in section II.D.2.c.ii. The concerns also include recognition that it will take time for installation of EVSE and necessary supporting electrical infrastructure by the BEV purchasers and associated electrical utility, as discussed in RTC section 7 (Distribution). They also include consideration of time to design, develop, and manufacture FCEV models and hydrogen infrastructure as discussed in RTC section 8.1, and willingness to purchase a relatively new technology. We project BEV technology adoption in the potential compliance pathway as early as MY 2027 for certain applications where we focused on depot charging, and we project adoption of BEV technology in applications that will depend on public charging and FCEV technology in the technology packages for the potential compliance pathway starting in MY 2030 for select applications that travel longer distances (*i.e.*, coach buses, sleeper cab tractors and day cab tractors). There has been only limited development of FCEVs for the HD market to date; therefore, our assessment is that it is appropriate to

provide manufacturers with additional lead time to design, develop, and manufacture FCEV models, but that it is feasible to do so by MY 2030, as discussed in section II.D.3. With substantial Federal investment in low-GHG hydrogen production (see RIA Chapter 1.8.2), we anticipate that hydrogen supply will be sufficient and the price of hydrogen fuel will fall in the 2030 to 2035 timeframe to make HD FCEVs cost-competitive with comparable ICE vehicles for some duty cycles, as discussed in section II.E.5.ii. We also note that the hydrogen infrastructure is expected to need additional time to further develop compared to BEV depot charging infrastructure, as discussed in greater detail in RIA Chapter 1.8, but our assessment is that refueling needs can be met by MY 2030. We also recognize the positive impact regulations can have on technology and recharging/refueling infrastructure development and deployment.

EPA granted the California ACT waiver request on March 30, 2023. The approach we used to support the feasibility of the final standards, described in this section II, was to develop technology packages on a nationwide basis and including nationwide production volumes, including vehicles sold to meet the ACT requirement in California and other states that have adopted or may adopt it under CAA section 177. With the granting of the California ACT waiver, we also considered how vehicles sold to meet the ACT requirement in California and other states that have adopted or may adopt it under CAA section 177 would impact our reference case (that is, the baseline from which we model projected effects of the final rule). For the final rule, to reflect the ZEV levels projected from ACT in California and other states, we included these projected ZEV sales volumes in the reference case.<sup>743</sup>

We have finalized the new Phase 3 CO<sub>2</sub> emission standards using the regulatory subcategories we adopted in HD GHG Phase 2, as discussed in section II.C. As we discuss later in this subsection, the technology packages vary across the 101 HD TRUCKS vehicle types and thus across the regulatory subcategories. Our technology packages

that support the feasibility of the final rule standards—*i.e.*, our modeled potential compliance pathway—include a projected mix of ICE vehicle, BEV, and FCEV technologies that are discussed in section II.F.1. Sections II.F.2 and II.F.3 include the costs and lead times associated with these technologies that we considered. In addition, for the final rule, to further illustrate that there are many potential pathways to compliance for the final standards with a wide range of potential technology mixes, we evaluated additional examples of other potential compliance pathway’s technology packages that also support the feasibility of the final standards, and which only include vehicles with ICE technologies (“additional example potential compliance pathways”) in section II.F.4.

We intend for the standards for each individual year are severable from standards for each of the other years, including that the earlier MYs (MY 2027 through MY 2029) are severable from the later MYs (MYs 2030 and later). More specifically, our analysis supports that the standards for each of the later years are feasible and appropriate even absent standards for each of the earlier years, and vice versa. For example, EPA’s revisions to certain MY 2027 standards are severable from the new MY 2028 and later standards because our analysis supports that the standards for each of the later years are feasible and appropriate even absent the revised MY 2027 standards. Additionally, we intend that the standards for each category of vocational vehicles and tractors for each individual model year are severable, including from the standards for all other categories for that model year, and from the standards for different model years. Thus, we intend each of the Phase 3 emission standards finalized in this rule to be entirely separate from each of the other Phase 3 emission standards and other varied components of this rule, and severable from each other. EPA has considered and adopted the Phase 3 emission standards and the remaining portions of the final rule independently, and each is severable should there be judicial review. For example, EPA notes that our judgments regarding feasibility of the Phase 3 standards for earlier years largely reflect anticipated changes in the heavy-duty vehicle market (which are driven by other factors, such as the IRA and manufacturers’ plans), while our judgment regarding feasibility of the standards in later years reflects those trends plus the additional lead time for further adoption of control technologies. Thus, the standards for the later years

<sup>743</sup> Because it would have been improper to prejudice the outcome of EPA’s disposition of California’s request for a preemption waiver for its ACT program, EPA did not include the full effects of that program as an enforceable program in the reference case (baseline) used at proposal, although we did make certain estimates of ZEV sales in California and other states that had adopted ACT under CAA section 177. 88 FR 25989.

are feasible even absent standards for the earlier years, and vice versa.

Additionally, our judgments regarding the standards for each separate vehicle category are likewise independent and do not rely on one another. For another example, EPA notes that our judgments regarding feasibility of the standards for vocational vehicles reflects our judgment regarding the general availability of depot-charging infrastructure in MY 2027 and for each later model year under the modeled potential compliance pathway, and that judgment is independent of our judgment regarding standards for tractors that reflects our judgment regarding more reliance on publicly available charging infrastructure and hydrogen refueling infrastructure in the MY 2030 and for each later model year under the modeled potential compliance pathway. Similarly, within the standards for vocational vehicles, our judgments regarding the feasibility of each model year of the standards for each category of vocational vehicles (LHD, MHD, and HHD) and for tractors (day cab and sleeper cab) reflects our judgments regarding the design requirements and payback analysis for each of the individual 101 vehicle types analyzed in HD TRUCS and then aggregated to the individual vehicle category, independent of those same kinds of judgments for the other vehicle categories and independent from prior MYs standards, under the modeled potential compliance pathway. See further discussion in RTC Chapter 2.10, regarding how EPA’s analysis for the modeled potential compliance pathway supports the feasibility for each MY of the Phase 3 final standards for each vehicle category, including phase-in factors up to MY 2032 and later that EPA used for a given Phase 3 MY and are independent of the prior Phase 3 MY(s) standards.

If a court were to invalidate any one of these elements of the final rule, we intend the remainder of this action to remain effective. Importantly, we have designed these different elements of the program to function sensibly and independently, the supporting basis for each of these elements of the final rule reflects that they are independently justified and appropriate, and find each portion appropriate even if one or more other parts of the rule has been set aside. For example, if a reviewing court were to invalidate the MY 2027 standards for LHD vocational vehicles, the other components of the rule, including the other Phase 3 GHG standards, remain fully operable as the remaining components for the rule would remain appropriate and feasible.

### 1. Technology Packages To Support the Feasibility of the Final Standards

We support the feasibility of the final standards through technology packages that include both ICE vehicle and ZEV technologies. In our analysis, the ICE vehicles include a suite of technologies that represent a vehicle that meets the existing MY 2027 Phase 2 CO<sub>2</sub> emission standards. These technologies exist today and continue to evolve to improve the efficiency of the engine, transmission, drivetrain, aerodynamics, and tire rolling resistance in HD vehicles and therefore reduce their CO<sub>2</sub> emissions. Further adoption of these Phase 2 ICE technologies beyond the adoption rates used in the HD GHG Phase 2 rule may be utilized as part of other example potential compliance pathways to meet the final standards, as discussed in section II.F.4. In addition, the heavy-duty industry continues to develop CO<sub>2</sub>-reducing technologies such as hybrid powertrains and H<sub>2</sub>-ICE powered vehicles, also discussed in section II.F.4 as part of other example potential compliance pathways to meet the final standards. These further technology improvements are not part of the technology packages for the modeled potential compliance pathway supporting the feasibility of the final standards but are included as specified in section II.F.4 in the additional example potential compliance pathways supporting the feasibility of the final standards. They are available to any manufacturer determining its own compliance pathway, and further support that the final Phase 3 standards are feasible and appropriate performance-based standards.

In the transportation sector, new technology adoption rates often follow an S-shape. As discussed in the preamble to the HD GHG Phase 2 final rule, the adoption rates for a specific technology are initially slow, followed by a rapid adoption period, then leveling off as the market saturates, and not always at 100 percent.<sup>744</sup> Two commenters agreed that technology adoption follows an S-shape, as we stated in the proposal.

In the proposal, we developed a method to project utilization of BEV and FCEV technologies in the HD vehicle technology packages after considering methods in the literature. There is limited existing data to support estimations of adoption rates of HD ZEV technologies. The methods considered and explored in the formulation of the method used in the proposal was developed by EPA after considering

methods in the literature to estimate the relationship between payback period and technology adoption in the HD vehicle market. We noted at proposal that we had explored the following methods: (1) the methods described in ACT Research’s ChargeForward report,<sup>745</sup> (2) NREL’s Transportation Technology Total Cost of Ownership (T3CO) tool,<sup>746</sup> (3) Oak Ridge National Laboratory’s Market Acceptance of Advanced Automotive Technologies (MA3T) model,<sup>747</sup> (4) Pacific Northwest National Laboratory’s Global Change Analysis Model (GCAM),<sup>748</sup> (5) ERM’s market growth analysis done on behalf of EDF,<sup>749</sup> (6) Energy Innovation’s United States Energy Policy Simulator used in a January 2023 analysis by ICCT and Energy Innovation,<sup>750</sup> and (7) CALSTART’s Drive to Zero Market Projection Model.<sup>751</sup> DRIA at 231. Of these methods explored for the proposal, only ACT Research’s work directly related payback period to technology adoption rates. We stated in the proposal that, based on our experience, payback is the most relevant metric to the HD vehicle industry. Thus, for the proposal, we considered the ACT Research method most relevant to assess willingness to purchase and modified their method, including to account for the effects of our proposed regulation, as described in DRIA Chapter 2.7.9.

There were many comments regarding EPA’s use of a payback metric at

<sup>745</sup> Mitchell, George. Memorandum to docket EPA-HQ-OAR-2022-0985. ACT Research Co. LLC. “Charging Forward” 2020–2040 BEV & FCEV Forecast & Analysis, updated December 2021.

<sup>746</sup> National Renewable Energy Laboratory. T3CO: Transportation Technology Total Cost of Ownership. Available at: <https://www.nrel.gov/transportation/t3co.html>.

<sup>747</sup> Oak Ridge National Laboratory. “MA3T-TruckChoice.” June 2021. Available at: [https://www.energy.gov/sites/default/files/2021-07/van021\\_lin\\_2021\\_o\\_5-28\\_1126pm\\_LR\\_FINAL\\_ML.pdf](https://www.energy.gov/sites/default/files/2021-07/van021_lin_2021_o_5-28_1126pm_LR_FINAL_ML.pdf).

<sup>748</sup> Pacific Northwest National Laboratory. GCAM: Global Change Analysis Model. <https://gcims.pnnl.gov/modeling/gcam-global-change-analysis-model>.

<sup>749</sup> Robo, Ellen and Dave Seamonds. Technical Memo to Environmental Defense Fund: Analysis of Alternative Medium- and Heavy-Duty Zero-Emission Vehicle Business-As-Usual Scenarios. ERM. August 19, 2022. Available online: <https://www.erm.com/contentassets/154d08e0d0674752925cd82c66b3e2b1/edf-zev-baseline-technical-memo-16may2022.pdf>.

<sup>750</sup> ICCT and Energy Innovation. “Analyzing the Impact of the Inflation Reduction Act on Electric Vehicle Uptake in the United States”. January 2023. Available online: <https://theicct.org/wp-content/uploads/2023/01/ira-impact-evs-us-jan23-2.pdf>.

<sup>751</sup> Al-Alawi, Baha M., Owen MacDonnell, Cristiano Facanha. “Global Sales Targets for Zero-Emission Medium- and Heavy-Duty Vehicles—Methods and Application”. February 2022. Available online: [https://globaldrivetozero.org/site/wp-content/uploads/2022/02/CALSTART\\_Global-Sales\\_White-Paper.pdf](https://globaldrivetozero.org/site/wp-content/uploads/2022/02/CALSTART_Global-Sales_White-Paper.pdf).

<sup>744</sup> 81 FR 73558, Oct 25, 2016.

proposal as a means of developing a potential compliance pathway that included the use of ZEVs. Two commenters said, considered alone, payback is an incomplete metric. Other factors to consider are reluctance to utilize a new technology, effects of inflation, vehicle suitability, resale value, end of the IRA and other price incentives, critical mineral availability, and availability of supportive charging infrastructure. One of these commenters cited ACT Research’s own evaluation that EPA should not have increased the adoption rates for payback periods greater than four years for MY 2032 and that our analysis should not have included payback-based adoption rates for payback periods beyond ten years, because this is beyond the payback period that would be acceptable. In addition, ACT Research did not agree with EPA using two different adoption schedules corresponding to MY 2027 and MY 2032. Another commenter stated that our use of the payback period table showing fleets purchasing BEVs and FCEVs at payback periods of up to 15 years in MY 2027, and beyond 15 years in MY 2032 are “unrealistic” because fleet owners look for payback periods of two years or less. Another commenter stated that EPA should adopt a more conservative payback schedule and suggested one in their comments.

Some commenters advocated for more stringent standards (see section II.B.1.i of this preamble). One of these commenters spoke to the length of a payback period, noting that payback periods well within a vehicle’s lifetime should be sufficient, noting especially that vocational vehicles have long ownership periods. They also questioned the purportedly relatively low percentages of projected ZEVs where EPA had estimated payback periods of 1–2 years. Another commenter noted that EPA’s projected compliance path showed less ZEV utilization than many estimates in the literature, citing BloombergNEF, as well as various of the ICCT White Papers and the levels required in California’s Advanced Clean Fleet program. Another commenter noted generally that total cost of ownership of BEVs would necessarily be less than for ICE vehicles due to their simpler drivetrains, which would occasion less maintenance costs.

As further detailed in RTC sections 2.4 and 3.12.2, some of these commenters criticized EPA’s use at proposal of the data from ACT Research’s payback equation. The critique from these commenters was both for lack of transparency—stating that the equation was proprietary and so

did not appear in the DRIA making comment difficult without getting access—and one commenter obtained the equation and asserted that they found no substantive basis for it. As just noted, in one commenter’s submitted comment, ACT Research itself reviewed the NPRM and stated that EPA had misapplied the equation by leaving out various factors, including a consideration of total cost of ownership in addition to payback period. Some commenters believed the total cost of ownership approach used in NREL’s Transportation Energy & Mobility Pathway Options (TEMPO) Model (Muratori et al., 2021) was a better way to assess the shape of the payback curve. One of these commenters stated that the NREL model “overcomes key deficiencies of the ACT Research-based curve by being based on validated empirical data, subject to peer-review, and freely available to the public.”<sup>752</sup> One commenter also provided an alternate distribution of adoption rate based on payback period developed from their assessment of the inputs from a NREL study using the TEMPO Model.<sup>753</sup> This commenter also suggested standards of significantly increased stringency using the data from the TEMPO model. The other commenter provided an alternate curve based on payback period developed from their assessment of the inputs and results from a NREL study using the TEMPO Model. Another commenter preferred an alternative method for assessing a ZEV-based acceptance. Their model uses a logit function less sensitive to price, developed by the Pacific Northwest Laboratory, and also uses a 15 percent discount rate.

We agree with the assessment asserted in comment that the approach developed by NREL for use in the TEMPO model is more transparent.<sup>754</sup> Furthermore, for the final rule, we further evaluated and found NREL’s TEMPO model and approach to be robust. The NREL TEMPO model is peer-reviewed and applicable to our use because it specifically evaluated HD ICE vehicles, BEVs, and FCEVs. We evaluated NREL’s approach to determining technology choices modeled in TEMPO using a discrete choice logit formulation.<sup>755</sup> We also

evaluated the work conducted by one commenter in development of their suggested alternative curve, which was derived from the TEMPO outputs. Our purpose was to assess the reasonableness of utilizing the TEMPO results for adoption rates and payback period relationships. We found the approach to be robust, and we were able to reproduce similar adoption rates for each payback period bin relative to those provided by the commenter. Therefore, based on our assessment that NREL’s TEMPO model is robust and the adoption rates to payback period relationship is reproducible, for the final rule, we are continuing to use the same payback period method we used in the proposal, but have revised the adoption rates that correspond to the payback period bins based on data from NREL’s TEMPO model instead of the use of the ACT Research-based model. See RIA Chapter 2.7 for additional details.

In the proposal, we applied an additional constraint (which at times we refer to as a “cap”) within HD TRUCS that limited the maximum penetration (*i.e.*, adoption percentage) of the BEV and FCEV technologies to 80 percent for any given vehicle type. This limit was developed after consideration of the actual needs of the purchasers related to two primary areas of our analysis. Our first consideration was that this volume limit takes into account that we sized the batteries, power electronics, e-motors, and infrastructure for each vehicle type based on the 90th percentile of the average VMT. As explained in section II.D.5, we utilized this technical assessment approach because we do not expect heavy-duty OEMs to design ZEV models for the 100th percentile VMT daily use case for vehicle applications, as this could significantly increase the ZEV powertrain size, weight, and costs for a ZEV application for all users, when only a relatively small part of the market will need such specifications. Therefore, the ZEVs we analyzed and have included in the technology packages and cost projections for the proposal and this

Furthermore, they express “TEMPO finds pathways to achieve energy/emissions goals and estimates implications of different scenarios and decisions.” A part of this decision process includes inputs such as vehicle cost and performance, fuel costs, charging and refueling availability, and travel behavior. The model receives this information and applies a technology adoption to various inputs and provides technology based on market segment as a part of the outputs for TEMPO. The method they used is based on a logit formulation to describe a relationship between consumer adoption and aforementioned inputs, cost coefficients and financial horizon. One commenter worked with NREL to provide the relationship between adoption rate and payback period.

<sup>752</sup> ICCT Comments to the HD GHG Phase 3 NPRM. EPA–HQ–OAR–2022–0985–1553–A1, p. 2.

<sup>753</sup> EDF Comments to Docket. EPA–HQ–OAR–2022–0985–1644–A1, p. 58–59.

<sup>754</sup> See also RIA Chapter 2.7 and RTC section 3.11.2 for additional discussion on the comments received.

<sup>755</sup> NREL describes “TEMPO is a transportation demand model that covers the entire U.S. transportation sector” including the HD market.



final rule in the timeframe at issue are likely not appropriate for 100 percent of the vehicle applications in the real-world. Our second consideration for including a limit for BEVs and FCEVs is that we recognize there is a wide variety of real-world operation even for the same type of vehicle. For example, some owners may not have the ability to install charging infrastructure at their facility, or some vehicles may need to be operational 24 hours a day. Under the technology pathway projected to support the feasibility for these final standards, ICE vehicle technologies continue to be included and available in volumes to address these specific vehicle applications.

The TEMPO model, as shown in RIA Chapter 2.7.1, would attribute 100 percent adoption to vehicles that have an immediate payback (payback less than or equal to 0 year). A number of commenters questioned the 80 percent limit in the HD TRUCS analysis. Two commenters found some merit to EPA's premise that a cap reflected that ZEVs would not be suitable for all applications, but both of these commenters maintained that this would be less and less over time. Consequently, these commenters thought EPA's methodology should at the least increase the cap in the standards' out years. One of these commenters also submitted an analysis without a cap (*i.e.*, with a 100 percent cap) where their model showed immediate payback. Under this alternative methodology, the commenter projected higher ZEV penetration for many of the vehicle Class 2–4 and 6–7 trucks, refuse trucks, and almost all bus segments. This commenter also noted these estimates did not consider the effects of the IRA. Both of these commenters also maintained that 80 percent was too conservative even for MY 2027, especially when coupled with the 90th percentile sizing VMT for the battery. Another commenter supported a cap of 90 percent.

Another commenter challenged the 80 percent cap as inconsistent with that commenter's purportedly extensive telematics data that showed the 90th percentile VMTs we used in the NPRM for day cab and sleeper cab tractors were too low, and suggested that Class 4–7 ZEVs with payback rates of <0 years would have an adoption rate of 73 percent, and Class 8 ZEVs with payback rates of <0 years would have an adoption rate of 36 percent, noting that these rates are consistent with CARB's 2019 initial market assessment for the ACT rule. This commenter also questioned why EPA's cap for those categories can be higher, that is, less

restrictive, than the applicable levels considered in ACT. Another commenter stated that the results from EPA's HD TRUCS would need to be further discounted to reflect that the charging and H2 fueling infrastructure would not be in place to meet the proposed MY 2027 through 2032 standards.

After consideration of comments, including concerns raised by manufacturers, we re-evaluated the maximum penetration constraints and "caps" in HD TRUCS for the final rule. The constraints discussed in the proposal, such as the methodology to size the batteries and the recognition of the variety of real-world applications of heavy-duty trucks, still apply to the final rule analysis. Furthermore, we are taking a phased-in approach to the constraints to recognize that the development of the ZEV market will take time to develop. We broadly considered the lead time necessary to increase heavy-duty battery production (as discussed in preamble section II.D.2.ii), including growth in the planned battery production capacity from now through 2032 and other issues including availability of critical minerals and related supply chains, and time for manufacturers to design, develop, and manufacture ZEVs (as discussed in preamble section II.F.3). We also have generally accounted for the time required to deploy infrastructure (as discussed in preamble section II.F.3), including the potential need for distribution grid buildout through 2032 as informed by our analysis and by the DOE's TEIS (as discussed in preamble section II.D.2.iii). We see a similar trend in the growth of the infrastructure to support H2 refueling for FCEVs (as discussed in preamble section II.D.3.v).

In recognition of these considerations, for the final rule we applied more conservative maximum penetration constraints within HD TRUCS than were used in the proposal and which are consistent with a balanced and measured approach generally, which in our assessment are appropriate and also address concerns raised by manufacturers. We limited the maximum penetration of the ZEV technologies in HD TRUCS to 20 percent in MY 2027, 37 percent in MY 2030 and 70 percent in MY 2032 for any given vehicle type. These caps are based upon an exercise of technical judgment after reviewing the entire record and reflect consideration of and address concerns about infrastructure readiness, willingness to purchase, and critical mineral and supply chain availability, reflecting that infrastructure, technology familiarity, and material availability

will have more limitations in MY 2027 (and thus taking a conservative approach to the levels of the caps in those earlier model years) but will be further developed by MY 2032, while also capping each vehicle type in HD TRUCS below the proposed value of 80 percent utilization of ZEV technologies including in MY 2032.

Put another way, depending on the MY, these caps in HD TRUCS reflect a balanced and measured approach to consideration of a combination of extreme use situations (including extremes of daily VMT), extreme usages such as continuous operation, and ensuring adequate lead time for the various considerations just explained. These real world constraints are not reflected in the TEMPO model used to develop payback; rather, the caps are part of EPA's appropriate consideration of these issues. Regarding additional responses to comments summarized here, please see RTC sections 2.4, 3.3.1 and 3.11.2, and see also RIA Chapter 2.7.

The payback schedule used in HD TRUCS for the final rule is shown in Table II–28. The schedule utilizes lower rates of technology acceptance than those used in the proposal for payback periods greater than four years. The schedule shows that when the payback is immediate, we project that up to 20 percent of that type of vehicle could use BEV technology in MY 2027 for the reasons just discussed, with diminishing adoption as the payback period increases to more than 4 years.<sup>756</sup> After consideration of comments from stakeholders, we also set the adoption rates to zero for payback bins that were greater than 10 years. The length of ownership of new tractors varies. One study found that first ownership is customarily four to seven years for For-Hire companies and seven to 12 years for private fleets.<sup>757</sup> Another survey found that the average trade-in cycle for tractors was 8.7 years.<sup>758</sup> Whereas, EMA and NADA stated that tractors typically have three to five year trade cycles.<sup>759</sup>

<sup>756</sup> See RIA Chapter 2.7.9 for additional information on the development of the adoption rate schedule for HD TRUCS for the final rule.

<sup>757</sup> Roeth, Mike, et al. "Barriers to Increased Adoption of Fuel Efficiency Technologies in Freight Trucking," Page 24. July 2013. International Council for Clean Transportation. Available at [https://theicct.org/sites/default/files/publications/ICCT-NACFE-CSS\\_Barriers\\_Report\\_Final\\_20130722.pdf](https://theicct.org/sites/default/files/publications/ICCT-NACFE-CSS_Barriers_Report_Final_20130722.pdf).

<sup>758</sup> American Transportation Research Institute. "An Analysis of the Operational Costs of Trucking: 2021 Update." November 2021. Page 14.

<sup>759</sup> See NADA's comments at Docket # EPA-HQ-OAR-20220-0985-1592-A1 at pp. 7–8 and EMA's comments at Docket # EPA-HQ-OAR-20220-0985-2668-A1 at p.48.

As we discussed in the HD GHG Phase 2 rulemaking, vocational vehicles generally accumulate far fewer annual miles than tractors and will lead owners of these vehicles to keep them for longer periods of time.<sup>760</sup> To the extent vocational vehicle owners may be similar to owners of tractors in terms of business profiles, they are more likely to resemble private fleets or owner-operators than for-hire fleets. See 81 FR 73719 (“the usual period of ownership for a vocational vehicle reflects a lengthy trade cycle that may often exceed seven years”). In addition, EMA and NADA stated that heavy-duty trucks

typically have trade cycles of seven to ten years for most operations.<sup>761</sup> The issues raised by commenters were thus considered, and issues raised by manufacturers were thus addressed, in our final rule’s approach to HD TRUCS and the projected technology packages: by applying the MY 2027, MY 2030 and MY 2032 caps, as discussed, and through lower ZEV adoption in the technology packages for payback periods that are longer than 4 years (including setting adoption to zero for payback bins greater than ten years) and higher (than longer payback periods) ZEV adoption when payback is 4 years or sooner. The relationship between

adoption and payback period that was created from TEMPO outputs differ from the ACT payback schedule used in the proposal and is reflective of a more typical S-curve, where adoption starts slow and then speeds up. Note, the 70 percent constraint we imposed and explained in this subsection limits the adoption of the shortest payback bins for MY 2032.

The schedule shown in Table II–28 was used in HD TRUCS to evaluate the use of BEV or FCEV technologies for each of the 101 HD TRUCS vehicle types based on its payback period for MYs 2027, 2030, and 2032.

**Table II-28 Payback Schedule in HD TRUCS**

Payback (year)	MY 2027 for BEVs	MY 2030 for BEVs and FCEVs	MY 2032 for BEVs and FCEVs
<0	20%	37%	70%
0-1	20%	37%	70%
1-2	20%	37%	70%
2-4	20%	26%	39%
4-7	14%	14%	14%
7-10	5%	5%	5%
>10	0%	0%	0%

After the technology assessment, as described in section II.D and RIA Chapter 2, and technology cost and payback analysis, as described in section II.E and RIA Chapter 2.7.2, EPA determined the technology mix of ICE vehicle and ZEV for each regulatory subcategory in the technology packages for the potential compliance pathway.

We first determined the ZEVs that are appropriate based on their payback for each of the 101 vehicle types for MYs 2027, 2030, and 2032, which can be found in RIA Chapter 2.8.3.1. We then aggregated the projected ZEVs for the specific vehicle types into their respective regulatory subcategories relative to the vehicle’s sales weighting,

as described in RIA Chapter 2.10.1. The resulting projected ZEVs (shown in Table II–29) and projected ICE vehicles that achieve a level of CO<sub>2</sub> emissions performance equal to the existing MY 2027 emission standards (shown in Table II–30) were built into our technology packages for the potential compliance pathway.

<sup>760</sup> 81 FR 73678 and 73719, October 25, 2016.

<sup>761</sup> See NADA’s comments at Docket # EPA–HQ–OAR–20220–0985–1592–A1 at pp. 7–8 and EMA’s

comments at Docket # EPA–HQ–OAR–20220–0985–2668–A1 at p.48.

**Table II-29 Projected Percentage ZEVs in the MYs 2027–2032 Technology Packages for the Modeled Potential Compliance Pathway**

Regulatory Subcategory	MY 2027	MY 2028	MY 2029	MY 2030	MY 2031	MY 2032
LHD Vocational	17%	22%	27%	32%	46%	60%
MHD Vocational	13%	16%	19%	22%	31%	40%
HHD Vocational	0%	0%	13%	15%	23%	30%
MHD All Cab and HHD Day Cab Tractors	0%	8%	12%	16%	28%	40%
Sleeper Cab Tractors	0%	0%	0%	6%	12%	25%
Heavy Haul Tractors	0%	0%	1%	1%	3%	5%
Optional Custom Chassis: School Bus	13%	16%	19%	22%	31%	40%
Optional Custom Chassis: Other Bus	0%	0%	13%	15%	23%	30%
Optional Custom Chassis: Coach Bus	0%	0%	0%	0%	0%	0%
Optional Custom Chassis: Refuse Hauler	0%	5%	10%	15%	16%	16%
Optional Custom Chassis: Concrete Mixer	0%	0%	0%	0%	0%	0%
Optional Custom Chassis: Emergency Vehicles	0%	0%	0%	0%	0%	0%
Optional Custom Chassis: Recreational Vehicles	0%	0%	0%	0%	0%	0%
Optional Custom Chassis: Mixed Use	0%	0%	0%	0%	0%	0%

**Table II-30 Projected Percentage of ICE Vehicles with CO<sub>2</sub>-Reducing Technologies that Meet Phase 2 MY 2027 CO<sub>2</sub> standards in the MY 2027-2032 Technology Packages for the Modeled Potential Compliance Pathway**

Regulatory Subcategory	MY 2027	MY 2028	MY 2029	MY 2030	MY 2031	MY 2032
LHD Vocational	83%	78%	73%	68%	54%	40%
MHD Vocational	87%	84%	81%	78%	69%	60%
HHD Vocational	100%	100%	87%	85%	77%	70%
MHD All Cab and HHD Day Cab Tractors	100%	92%	88%	84%	73%	60%
Sleeper Cab Tractors	100%	100%	100%	94%	88%	75%
Heavy Haul Tractors	100%	100%	99%	99%	97%	95%
Optional Custom Chassis: School Bus	87%	84%	81%	78%	69%	60%
Optional Custom Chassis: Other Bus	100%	100%	87%	85%	77%	70%
Optional Custom Chassis: Coach Bus	100%	100%	100%	100%	100%	100%
Optional Custom Chassis: Refuse Hauler	100%	90%	90%	85%	84%	84%
Optional Custom Chassis: Concrete Mixer	100%	100%	100%	100%	100%	100%
Optional Custom Chassis: Emergency Vehicles	100%	100%	100%	100%	100%	100%
Optional Custom Chassis: Recreational Vehicles	100%	100%	100%	100%	100%	100%
Optional Custom Chassis: Mixed Use	100%	100%	100%	100%	100%	100%

As shown in Table II–30, under the modeled potential compliance pathway the majority of sales of new HD vehicles in MYs 2027 through 2032 are projected to be ICE vehicles with GHG-reducing technologies. These values represent the total national HD ZEV and ICE vehicle sales, including those accounted for in

the reference case as described in section V.A. The portion of the overall HD sales in MY 2027 that are ZEVs included in the reference case is 7 percent, compared to 11 percent of sales being ZEVs across the nation due to the final rule under our modeled potential compliance pathway, as shown in Table

II–31. Similarly, in the MY 2032 reference case, 20 percent of the HD sales are projected to be ZEVs, versus 45 percent ZEVs in the HD national fleet with the potential compliance pathway modeled for the final rule, respectively.

**Table II-31 HD ZEV Nationwide Percentages in Reference Case and Modeled Potential Compliance Pathway**

	MY 2027	MY 2028	MY 2029	MY 2030	MY 2031	MY 2032
Reference Case	7%	10%	13%	16%	18%	20%
Modeled Potential Compliance Pathway	11%	15%	19%	23%	34%	45%

The composition of the overall HD on-road fleet in future years with the final rule under our modeled potential compliance pathway and accounting for ZEVs in the reference case, is projected to include the following:

- In 2027: 1 percent of the on-road fleet are ZEVs.
- In 2032: 7 percent of the on-road fleet are ZEVs.
- In 2040: 22 percent of the on-road fleet are ZEVs.

For the final standards, EPA did not revise (*i.e.*, is not finalizing the proposed revision to) the MY 2027 or 2028 CO<sub>2</sub> emission standards for the HHD vocational vehicles but have set new CO<sub>2</sub> emission standards for HHD vocational vehicles beginning in MYs 2029 through 2032. Similarly, we are not revising the MY 2027 day cab tractor standards, but have set new standards beginning in MY 2028. Our reference case modeling does include some HHD vocational and day cab tractor ZEVs in MY 2027 and HHD vocational ZEVs in MY 2028. This is our best estimate of ZEV technology penetration for the reference case. Nonetheless, we recognize the significant uncertainties associated with the commercializing of these technologies in the HHD space, which are still in their infancy today. We also recognize that vehicle manufacturers may have different technology pathway plans to demonstrate compliance with ACT, and we acknowledge that certain vehicle manufacturer comments stated that they do not expect to produce a significant number of HHD ZEVs by MY 2028 because the HHD vocational vehicles will be one of the most challenging groups in which to utilize such technologies. Our revised analysis for the final rule projects lower levels of HHD ZEVs in the compliance pathways for MYs 2027–2032 than the proposal. It also delays the start of the Phase 3 standards for day cabs by one year, beginning in MY 2028. We recognize that the manufacturers’ resources will require them to make practical business decisions to first develop products that will have a better business case. Our assessment of the final program as a whole is that it takes a balanced approach while still applying meaningful requirements in MY 2027 to reducing GHG emissions from the HD sector. In light of these challenges and

uncertainties, including those associated with utilizing such technologies in the nearest term for HHD vocational vehicles, the potential disparities between manufacturers in the need for lead time and their corresponding compliance strategies, and the overall strengthening of the program in MY 2027 under Phase 3, we think it is reasonable to not revise the HHD vocational vehicle emission standards for MY 2027 or 2028. In addition, we are not revising the day cab tractor emission standards for MY 2027 for similar reasons.

The HD GHG Phase 2 program includes optional custom chassis emission standards for eight specific vehicle types. Those vehicle types may either meet the primary vocational vehicle program standards or, at the vehicle manufacturer’s option, may comply with these optional standards. The existing optional custom chassis standards are numerically less stringent than the primary HD GHG Phase 2 vocational vehicle standards, but the ABT program is more restrictive for vehicles certified to these optional standards. Banking and trading of credits is not permitted, with the exception that small businesses may use traded credits to comply with the optional custom-chassis standards. Averaging is only allowed within each specific custom chassis regulatory subcategory for vehicles certified to these optional standards. If a manufacturer wishes to make use of the full ABT program, from the production of some or all of their custom-chassis vehicles in a given model year, they may certify them to the primary vocational vehicle standards.

In this final action, as presented previously in this section, we are adopting more stringent standards for some, but not all, of these optional custom chassis subcategories. We are revising MY 2027 emission standards and establishing new MY 2028 through MY 2032 and later emission standards for the school bus optional custom chassis regulatory subcategory. We are also establishing new MY 2028 through MY 2032 and later emission standards for refuse hauler optional custom chassis subcategory and new MY 2029 through MY 2032 and later emission

standards for the other bus optional custom chassis subcategory.<sup>762</sup>

We are finalizing the approach we proposed for several other optional custom chassis categories. We are finalizing our proposed approach to not set Phase 3 standards for motor homes certified to the optional custom chassis regulatory subcategory after consideration of projected technologies for motor homes, including the projected impact of the weight of batteries in BEVs in the MYs 2027–2032, as described in RIA Chapter 2.8.1. This approach was supported by two commenters. The existing Phase 2 optional custom chassis standards for this subcategory will continue to apply. Furthermore, we also are not finalizing Phase 3 standards for emergency vehicles certified to the optional custom chassis regulatory subcategory due to our assessment that these vehicles have unpredictable operational requirements and after considering suitability of projected technologies, including that emergency vehicles may have limited access to recharging facilities while handling emergency situations in the MYs 2027–2032 timeframe. Finally, we are not adopting new standards for mixed-use vehicle optional custom chassis regulatory subcategory because of our assessment that these vehicles (such as hazardous material equipment or off-road drill equipment) are designed to work inherently in an off-road environment or are designed to operate at low speeds such as to be unsuitable for normal highway operation and, after consideration of suitability of projected technologies, including that they therefore may have limited access to on-site depot or public charging facilities in the MYs 2027–2032 timeframe.<sup>763</sup> The existing Phase 2 optional custom chassis standards for this subcategory will continue to apply.

We also are not finalizing Phase 3 standards for two other optional custom chassis categories. Several stakeholders raised significant concerns related to the ability of coach buses to perform their

<sup>762</sup> See 40 CFR 1037.105(h)(1) for the final standards that apply for custom chassis vehicles. See existing 40 CFR 1037.105(h)(2) for restrictions on averaging, banking, and trading for vehicles optionally certified to the custom chassis standards.

<sup>763</sup> Mixed-use vehicles must meet the criteria as described in 40 CFR 1037.105(h)(1), 1037.631(a)(1), and 1037.631(a)(2).

mission (transporting people and their cargo) using battery electric technology. Furthermore, commenters raised concerns regarding the infrastructure needs for electrified motorcoaches because these vehicles would need to rely on public enroute charging. As noted in RIA Chapter 1.5.5, there are currently two manufacturers of coach buses that produce BEV versions of the vehicles. We note that there are a variety of different applications of a coach bus. In some instances, it may be used for a day trip or for commuting and require minimal underfloor luggage space and may not require a restroom. Another common use is for trips with longer distances such that passengers travel with luggage or sports equipment that requires underfloor storage. EPA contracted FEV to conduct analysis of the packaging feasibility of a FCEV powertrain on a coach bus to inform the final rule. FEV found that a FCEV powertrain would require the loss of 2–4 seats and 30 percent of the luggage volume.<sup>764</sup> The capacity loss was driven by the space needed for the hydrogen tanks, fuel cell with BOP, and/or batteries. Our assessment is that the weight and volume required for packaging a BEV powertrain would be greater than the requirements for a FCEV powertrain, and therefore result in even greater capacity losses. After further consideration of suitability of projected technologies, including EPA re-analyzing the packaging space available for battery electric and fuel cell powertrains on coach buses, EPA now agrees with the commenters that feasibility demonstrations for new Phase 3 optional custom chassis standards for coach buses during the timeframe of the final rule should not include application of BEV or FCEV technology due to the packaging space required to meet commercial range requirements while also having adequate luggage space. Therefore, EPA’s optional custom chassis standards for Coach Buses will remain unchanged from the existing Phase 2 MY 2027+ CO<sub>2</sub> emission standards. However, as discussed in RIA Chapter 2.9.1.2, we project that there will be some applications of coach buses that will be appropriate as ZEVs and we therefore have considered these types of vehicles in the technology package that supports the modeled potential compliance pathway for the primary vocational vehicle standards.

Several manufacturers and associations raised concerns regarding

<sup>764</sup> FEV Consulting, “Heavy Duty Commercial Vehicles Class 4 to 8: Technology and Cost Evaluation for Electrified Powertrains—Final Report”. Prepared for EPA. March 2024.

the ability of concrete mixers and pumpers to electrify. They point to issues related to higher PTO usage, traveling at loads higher than those used in EPA’s HD TRUCS analysis, and weight sensitivity. One commenter maintains that energy used by concrete mixers is significantly higher than what is represented in GEM and suggests the underestimated load requirements (and therefore energy requirements) result in smaller battery sizes and lower costs in HD TRUCS than what that commenter expects. The commenter states that, as a result, concrete mixers should have unique standards from other vocational vehicles based on lower adoption rates. On the other hand, another commenter provided links to several electrified concrete mixer and pumpers where prototypes have been supplied to customers in Europe. Additionally, another commenter stated that EPA should set more stringent standards for concrete mixers based on their emissions impact on overburdened communities. For the final rule, EPA increased the PTO loads required for concrete mixers and pumpers in our HD TRUCS analysis based on consideration of information provided by another commenter, and therefore these vehicles have larger power demands and battery sizes in the final rule HD TRUCS analysis than the vehicles had in the NPRM analysis. In recognition of the uncertainty related to the payload weight and PTO demands of these vehicles, EPA determined that the optional custom chassis standards for Concrete Mixers/Pumpers and Mixed-Use Vehicles will remain unchanged from the existing Phase 2 custom chassis emission standards. See RIA Chapter 2.9.1.1. However, because there are prototypes for some electrified concrete mixers and pumpers, we continued to include several of these vehicle types within HD TRUCS where they are modeled as part of the compliance pathway for HHD vocational vehicles. See RIA Chapter 2.9.1.1.

We note that we do not have concerns that manufacturers of any of the custom chassis types of vehicles could inappropriately circumvent the final vocational vehicle standards or the final optional custom chassis standards. This is because vocational vehicles are built to serve a purpose which is readily identifiable. For example, a manufacturer cannot certify a box truck to the emergency vehicle custom chassis standards.

## 2. Summary of Costs Assessment To Meet the Final Emission Standards

We supported the feasibility of the final standards through a potential compliance pathway’s projected technology packages that include both ICE vehicle and ZEV technologies. To assess the projected costs of the final Phase 3 emission standards, we thus assess the costs of the potential compliance pathway’s projected technology packages. In our analysis, the ICE vehicles include a suite of technologies that represent a vehicle that meets the existing MY 2027 Phase 2 CO<sub>2</sub> emission standards and HD 2027 NOx emission standards. We accounted for these technology costs as part of the HD GHG Phase 2 final rule and the HD 2027 NOx rule. Therefore, our technology costs for the ICE vehicles in our analysis are considered to be \$0 because we did not add additional CO<sub>2</sub>-reducing technologies to the ICE vehicles in the technology packages for this final rule beyond those already required under the existing regulations. The incremental cost of a heavy-duty ZEV in our analysis is the marginal cost of ZEV powertrain components compared to ICE powertrain components on a comparable ICE vehicle. This includes the removal of the associated costs of ICE-specific components from the baseline vehicle and the addition of the ZEV components and associated costs. RIA Chapter 2.3.2 and 2.4.3 includes the ICE powertrain and BEV powertrain cost estimates for each of the 101 HD vehicle types that are included in our technology packages to support the compliance pathway. RIA Chapter 2.5.2 includes the FCEV powertrain cost projections for the applicable vehicles.

### i. Manufacturer Costs

Table II–32 and Table II–33 show the ZEV technology costs for manufacturers relative to the reference case described in section V.A.1, including the direct manufacturing costs that reflect learning effects, the indirect costs, and the IRA section 13502 Advanced Manufacturing Production Credit, on average aggregated by regulatory group for MYs 2027 and 2032, respectively.<sup>765</sup> The incremental ZEV adoption rate in our modeled potential compliance pathway technology package reflects the difference between the ZEV adoption rates in the technology packages that support the feasibility of our final standards and the reference case. As shown in Table II–32 through Table II–34, we project that some vocational

<sup>765</sup> Indirect costs are described in detail in section IV.B.2.

BEVs will cost less to produce than comparable ICE vehicle types by MY 2032 or earlier. Our analysis is consistent with other studies. For example, an EDF/Roush study found that by MY 2027, BEV transit buses, school buses, delivery vans, and refuse haulers would each cost less upfront

than a comparable ICE vehicle.<sup>766</sup> ICCT similarly found that “although zero-emission trucks are more expensive in the near-term than their diesel equivalents, electric trucks will be less expensive than diesel in the 2025–2030 time frame, due to declining costs of batteries and electric motors as well as

increasing diesel truck costs due to emission standards compliance.”<sup>767</sup> These studies were developed prior to passage of the IRA, and therefore we would expect the cost comparisons to be even more favorable after considering the IRA provisions.

BILLING CODE 6560–50–P

**Table II-32 Manufacturer Costs to Meet the Final MY 2027 Standards Through the Potential Compliance Pathway Relative to the Reference Case (2022\$)**

Regulatory Group	Incremental ZEV Adoption Rate in Technology Package	Per-ZEV Manufacturer RPE on Average	Fleet-Average Per-Vehicle Manufacturer RPE
LHD Vocational Vehicles	7%	-\$4,100	-\$283
MHD Vocational Vehicles	6%	\$3,959	\$242
HHD Vocational Vehicles	0%	N/A	\$0
Day Cab and Heavy Haul Tractors	0%	N/A	\$0
Sleeper Cab Tractors	0%	N/A	\$0

Note: The average costs represent the average across the regulatory group. For example, the first row represents the average across all LHD vocational vehicles.

**Table II-33 Manufacturer Costs to Meet the Final MY 2030 Standards Through the Potential Compliance Pathway Relative to the Reference Case (2022\$)**

Regulatory Group	Incremental ZEV Adoption Rate in Technology Package	Per-ZEV Manufacturer RPE on Average	Fleet-Average Per-Vehicle Manufacturer RPE
LHD Vocational Vehicles	7%	-\$10,637	-\$723
MHD Vocational Vehicles	5%	-\$6,164	-\$296
HHD Vocational Vehicles	4%	-\$7,582	-\$273
Day Cab and Heavy Haul Tractors	7%	\$32	\$2
Sleeper Cab Tractors	4%	\$41,877	\$1,717

Note: The average costs represent the average across the regulatory group. For example, the first row represents the average across all LHD vocational vehicles.

<sup>766</sup>Nair, Vishnu; Sawyer Stone; Gary Rogers; Sajit Pillai; Roush Industries, Inc. “Technical Review: Medium and Heavy Duty Electrification Costs for MY 2027–2030.” February 2022. Page 18. Last accessed on February 9, 2023 at [https://](https://blogs.edf.org/climate411/files/2022/02/EDF-MDHD-Electrification-v1.6_20220209.pdf)

[blogs.edf.org/climate411/files/2022/02/EDF-MDHD-Electrification-v1.6\\_20220209.pdf](https://blogs.edf.org/climate411/files/2022/02/EDF-MDHD-Electrification-v1.6_20220209.pdf).

<sup>767</sup>Hall, Dale and Nic Lutsey. “Estimating the Infrastructure Needs and Costs for the Launch of

Zero-Emission Trucks.” February 2019. Page 4. Last accessed on February 9, 2023 at [https://theicct.org/wp-content/uploads/2021/06/ICCT\\_EV\\_HDVs\\_Infrastructure\\_20190809.pdf](https://theicct.org/wp-content/uploads/2021/06/ICCT_EV_HDVs_Infrastructure_20190809.pdf).

**Table II-34 Manufacturer Costs to Meet the Final MY 2032 Standards Through the Potential Compliance Pathway Relative to the Reference Case (2022\$)**

Regulatory Group	Incremental ZEV Adoption Rate in Technology Package	Per-ZEV Manufacturer RPE on Average	Fleet-Average Per-Vehicle Manufacturer RPE
LHD Vocational Vehicles	30%	-\$9,776	-\$2,923
MHD Vocational Vehicles	20%	-\$5,033	-\$981
HHD Vocational Vehicles	16%	-\$3,989	-\$654
Day Cab and Heavy Haul Tractors	30%	\$10,816	\$3,202
Sleeper Cab Tractors	20%	\$53,295	\$10,819

Note: The average costs represent the average across the regulatory group. For example, the first row represents the average across all LHD vocational vehicles.

ii. Purchaser Costs

We also evaluated the costs of the final standards for purchasers on average by regulatory group, as shown in Table II-35 through Table II-37. Our assessment of the upfront purchaser costs includes the incremental cost of a ZEV relative to a comparable ICE vehicle after accounting for the two IRA tax credits (IRA section 13502, “Advanced Manufacturing Production

Credit,” and IRA section 13403, “Qualified Commercial Clean Vehicles”) including the applicable FET and sales tax, and the associated EVSE costs (including IRA section 13404, “Alternative Fuel Refueling Property Credit”), if applicable. We also assessed the incremental annual operating costs of a ZEV relative to a comparable ICE vehicle, which include the refueling/charging costs, maintenance and repair

costs, and insurance costs. The operating costs for BEVs include charging costs that reflect either depot charging or public charging, depending on the vehicle type. The payback periods shown reflect the number of years it is projected to take for the annual operating savings to offset the increase in total upfront costs for the purchaser for the sales-weighted average within a regulatory group.

**Table II-35 MY 2027 Purchaser Per-ZEV Upfront Costs, Operating Costs, and Payback Period (2022\$)**

Regulatory Group	Adoption Rate in Technology Package	Incremental Per-ZEV RPE Cost on Average (before IRA Purchase Tax Credit and Taxes)	EVSE Costs Per-ZEV on Average	Total Incremental Upfront Per-ZEV Costs on Average Including Taxes	Annual Incremental Operating Costs Per-ZEV on Average	Payback Period (year) on Average
LHD Vocational Vehicles	17%	-\$4,100	\$11,623	\$7,165	-\$3,383	3
MHD Vocational Vehicles	13%	\$3,959	\$17,084	\$17,283	-\$4,692	5
HHD Vocational Vehicles	0%	N/A	N/A	N/A	N/A	N/A
Day Cab and Heavy Haul Tractors	0%	N/A	N/A	N/A	N/A	N/A
Sleeper Cab Tractors	0%	N/A	N/A	N/A	N/A	N/A

Note: The average costs represent the average across the regulatory group, for example the first row represents the average across all LHD vocational vehicles.

**Table II-36 MY 2030 Purchaser Per-ZEV Upfront Costs, Operating Costs, and Payback Period (2022\$)**

Regulatory Group	Adoption Rate in Technology Package	Incremental Per-ZEV RPE Cost on Average (before IRA Purchase Tax Credit and Taxes)	EVSE Costs Per-ZEV on Average	Total Incremental Upfront Per-ZEV Costs on Average Including Taxes	Annual Incremental Operating Costs Per-ZEV on Average	Payback Period (year) on Average
LHD Vocational Vehicles	32%	-\$10,637	\$11,800	\$629	-\$3,626	1
MHD Vocational Vehicles	22%	-\$6,164	\$16,133	\$9,325	-\$5,020	3
HHD Vocational Vehicles	15%	-\$7,582	\$48,099	\$34,532	-\$10,412	4
Day Cab and Heavy Haul Tractors	16%	\$32	\$14,272	\$7,168	-\$5,708	3
Sleeper Cab Tractors	6%	\$41,877	\$0	\$11,709	-\$9,034	3

Note: The average costs represent the average across the regulatory group, for example the first row represents the average across all LHD vocational vehicles.

**Table II-37 MY 2032 Purchaser Per-ZEV Upfront Costs, Operating Costs, and Payback Period (2022\$)**

Regulatory Group	Adoption Rate in Technology Package	Incremental Per-ZEV RPE Cost on Average (before IRA Purchase Tax Credit and Taxes)	EVSE Costs Per-ZEV on Average	Total Incremental Upfront Per-ZEV Costs on Average Including Taxes	Annual Incremental Operating Costs Per-ZEV on Average	Payback Period (year) on Average
LHD Vocational Vehicles	60%	-\$9,776	\$11,736	\$1,470	-\$3,682	2
MHD Vocational Vehicles	40%	-\$5,033	\$15,304	\$9,678	-\$5,132	3
HHD Vocational Vehicles	30%	-\$3,989	\$46,204	\$34,505	-\$10,514	4
Day Cab and Heavy Haul Tractors	40%	\$10,816	\$5,952	\$4,418	-\$5,516	2
Sleeper Cab Tractors	25%	\$53,295	\$0	\$22,366	-\$8,303	5

Note: The average costs represent the average across the regulatory group, for example the first row represents the average across all LHD vocational vehicles.

**BILLING CODE 6560-50-C**

As shown in Table II-37, we estimate that the average upfront cost per vehicle to purchase a new MY 2032 vocational ZEV and associated EVSE compared to a comparable ICE vehicle (after accounting for two IRA tax credits, IRA section 13502, “Advanced Manufacturing Production Credit,” and IRA section 13403, “Qualified Commercial Clean Vehicles”), will be offset by operational costs (*i.e.*, savings that come from the lower costs to operate, maintain, and repair ZEV technologies), such that we expect the upfront cost increase will be recouped due to operating savings in two to four years on average for vocational vehicles, two years on average for day cab

tractors, and five years on average for sleeper cab tractors. We discuss this in more detail and provide the payback period for each of the HD TRUCS vehicle types in RIA Chapter 2.7.

The average per-vehicle purchaser costs shown in Table II-35 for MY 2027 are higher than the MY 2032 per-vehicle costs. The reduction in costs over time are reflective of technology learning, as discussed in section IV.B. It is worth noting that though the upfront costs of a BEV MHD vocational vehicle, for example, are higher when one considers both the vehicle and the EVSE, purchasers will still recoup these upfront costs within three years of ownership on average. This is within the period of first ownership, as

explained in the previous subsection. Also of note, our MY 2027 technology package for this final rule has a significantly lower adoption rate for these MHD vocational vehicles in MY 2027 than in MY 2032, reflecting the higher cost in MY 2027 than in MY 2032. Purchasers considering a ZEV also will have the option to consider alternatives to purchasing an EVSE at the time of purchasing a vehicle. For example, depending on the location of the vehicle, heavy-duty public charging may be a better solution than depot charging. Instead of spending upfront for EVSE, the purchaser could instead spread the cost over time through public charging where the EVSE costs would be built into the electricity cost or



through the use of Charging as a Service. Purchasers of course could choose an ICE vehicle as well if that best suits their needs.

### 3. Lead Time Assessment

Two of the significant aspects of the IRA are the tax credit available for the manufacturing of batteries and the tax credit available for the purchase of HD ZEVs, where the IRA provisions' qualifications are met. The tax credits significantly reduce, and in many cases erase, the incremental cost of purchasing a HD ZEV when compared to the cost of purchasing a comparable ICE vehicle. Therefore, as explained in our payback analysis, we expect the IRA will incentivize the demand and willingness to purchase for HD ZEVs. However, demand and willingness to purchase are only two of the factors we considered when evaluating the feasibility and suitability of HD ZEV technologies in the MY 2027 through MY 2032 timeframe, for inclusion in the potential compliance pathway's technology packages to support the feasibility of the Phase 3 standards in that timeframe. We also considered the lead time required for manufacturers to design, develop, and produce the ZEV and ICE vehicle technologies in the projected technology packages, in addition to lead time considerations relating to availability of charging and hydrogen refueling infrastructure, and availability of critical minerals and resiliency of related supply chains.

As noted in the proposal for this rule, heavy-duty manufacturers have indicated it could take two to four or more years to design, develop, and prove the safety and reliability of a new HD vehicle. 88 FR 25998. A typical design process includes the design and building of prototype or demonstration vehicles that are evaluated over several months or years in real world operation. The manufacturers need to accumulate miles and experience a wide variety of environmental conditions on these prototype vehicles to demonstrate the product's durability and reliability. Then manufacturers would work to commercialize the vehicle and in turn build it in mass production. We also considered that manufacturers are likely limited in terms of the financial resources, human resources, and testing facilities to redesign all of their vehicles at the same time and, instead, focus on the applications with the best business case because these would be where the customers would be most willing to purchase. Manufacturers reiterated the need for lead time in their comments on the proposed rule. See RTC section 2.3.3.

The final Phase 3 standards phase in over time from MY 2027 through MY 2032. For HD BEVs in the potential compliance pathway, we considered that BEV technology has been demonstrated to be technically feasible in heavy-duty transportation and that manufacturers will learn from the research and development work that has gone into developing the significant number of LD and HD electric vehicle models that are on the road today, as noted in section II.D.2 and RIA Chapter 1.5.5. The feasibility of our final standards is supported by technology packages with increasing BEV adoption rates beginning in MY 2027 (see also our discussion in this section II.D.2.iii regarding our consideration of adequate time for infrastructure development for HD BEVs). For HD FCEVs, as discussed in section II.D.3 and II.D.4, along with RIA Chapter 1.7.5, fuel cell technology in other sectors has been in existence for decades, it has been demonstrated to be technically feasible in heavy-duty transportation, and there are a number of HD FCEV models that are commercially available today with more expected to become available by 2024. However, we included this technology as part of potential compliance pathway's technology packages supporting the feasibility of our final standards starting in MY 2030 in part to take into consideration lead time to allow manufacturers to design, develop, and manufacture HD FCEV models (see also our discussion in this subsection regarding our consideration of adequate time for infrastructure development for HD FCEVs).

We discuss in sections II.D.1 and II.F.1 the need for ICE vehicles to continue to install CO<sub>2</sub>-reducing technologies, such as advanced aerodynamics, advanced transmissions, efficient powertrains, and lower rolling resistance tires to meet the previously promulgated MY 2027 Phase 2 standards. In our technology assessment for this final rule and the potential compliance pathway's technology packages to support the feasibility of the Phase 3 standards, we included ICE vehicle technologies for a portion of each of the technology packages, and those ICE vehicle technologies mirrored the technology packages we considered in setting the previously promulgated Phase 2 MY 2027 CO<sub>2</sub> emission standards. Each of these technologies exists today and continues to be developed by manufacturers. As noted in 2016 when we issued the HD GHG Phase 2 final rule, at that time we provided over ten years of lead time to the manufacturers to continue the

development and deployment of these technologies. Our current assessment is that these ICE vehicle technologies continue to have adequate lead time and be feasible in the MY 2027 and later timeframe, as discussed in section II.D.1.

As a new vehicle is being designed and developed, our projected technology packages include consideration that manufacturers will also need time to significantly increase HD ZEV production volumes from today's volumes. In particular, our analysis for the potential compliance pathway considers that manufacturers will need to build new powertrains or to modify existing manufacturing production lines to assemble the new products that include ZEV powertrains. Our analysis for our potential compliance pathway also considered that manufacturers will require time to source new components, such as heavy-duty battery packs, motors, fuel cell stacks, and other ZEV components, including the sourcing of the critical minerals, as discussed in section II.D.2.i. As described in section II.D.5, our potential compliance pathway's technology packages project that manufacturers will not develop vehicles utilizing ZEV technologies to cover all types of HD vehicles at once but will focus on those with the most favorable business case first, increase the adoption of those vehicles over time, and then develop other applications. We also note that we have added temporary compliance flexibilities to the rule, including the ability to average, bank, and trade credits across averaging sets for certain HD vehicles as described in section III.A, and have done so to facilitate compliance flexibility (although, as noted in section II.G.2, these flexibilities are not necessary to EPA's determination that the final standards are feasible, provide sufficient lead time, and are appropriate within the meaning of CAA section 202(a)(1)).

Several of the Phase 3 standards commence in MY 2027, but certain standards do not; namely, the Phase 3 standards for HHD vocational vehicles commence in MY 2029, the day cab tractors commence in MY 2028, and the standards for sleeper cab tractors commence in MY 2030. We believe our approach described in section II.D.5 demonstrates the feasibility of the final standards through our potential compliance pathway's technology packages, including through the technology packages reflecting the ZEV adoption rates for the applications we have determined are achievable in the MY 2027 and later timeframe.

Purchasers of BEVs will also need to consider how they will charge their vehicles. Our assessment of EVSE technology and costs associated with charging is included in sections II.E.2, II.E.5, and II.F.4 of this preamble, RIA Chapter 1, and RIA Chapter 2. We anticipate that many first-time BEV owners may opt to purchase and install EVSE at or near the time of vehicle purchase for charging at their depot, and we therefore account for these capital costs upfront. As noted in RIA Chapter 1, we expect significant increases in HD charging infrastructure due to a combination of public and private investments. This includes Federal funding available through the BIL<sup>768</sup> and the IRA.<sup>769</sup> As discussed in section II.D.2.iii and RTC section 7 (Distribution), OEMs, utilities, EVSE providers and others are also investing in and supporting the deployment of charging infrastructure. We also there discuss demand on the grid posed by the transportation sector (both light-duty and heavy-duty) on a national level, both in the areas of the high-volume freight corridors that are the most likely targets for deployment of heavy-duty BEVs during the rule's time frame and on a parcel level in particular states and nationally. Our conclusions, as there discussed, are that there is adequate lead time for deployment of distribution grid buildout for both depot and public charging, and we include consideration of costs in our analysis.

In addition to the anticipated build out of charging infrastructure and electric distribution grids which we analyzed, innovative charging solutions can further reduce lead times to deploying HD BEVs. As discussed in section II.D.2.iii of this preamble, one approach is for utilities to make non-firm capacity available immediately as they construct distribution system upgrades. In California, Southern California Edison (SCE) proposed a two-year Automated Load Control Management Systems (LCMS) Pilot.<sup>770</sup>

<sup>768</sup> Infrastructure Investment and Jobs Act, Pub. L. No. 117–58, 135 Stat. 429 (2021), available at <https://www.congress.gov/117/plaws/publ58/PLAW-117publ58.pdf>.

<sup>769</sup> Inflation Reduction Act, Pub. L. 117–169, 136 Stat. 1818 (2022).

<sup>770</sup> The program would use third-party owned LCMS equipment approved by SCE to accelerate the connection of new loads, including new EVSE, while “SCE completes necessary upgrades in areas with capacity constraints.” SCE would use the LCMS to require new customers to limit consumption during periods when the system is more constrained, while providing those customers access to the distribution system sooner than would otherwise be possible. Once SCE completes required grid upgrades, the LCMS limits will be removed, and participating customers will gain unrestricted distribution service. SCE hopes to

Plans like SCE's to use LCMS to connect new EV loads faster in constrained sections of the grid will be bolstered by standards for load control technologies. UL, an organization that develops standards for the electronics industry, drafted the UL 3141 Outline of Investigation (OOI) for Power Control Systems (PCS). Once finalized, manufacturers will be able to use this standard for developing devices that utilities can use to limit the energy consumption of BEVs. The OOI identifies five potential functions for PCS. One of these functions is to serve as a Power Import Limit (PIL) or Power Export Limit (PEL). In these use cases, the PCS controls the flow of power between a local electric power system (local EPS, most often the building wiring on a single premises) and a broader area electric power system (area EPS, most often the utility's system). Critically, the standardized PIL function will enable the interconnection of new BEV charging stations faster by leveraging the flexibility of BEVs to charge in coordination with other loads at the premise. With this standard in place and manufacturer completion of conforming products, utilities will have a clear technological framework available to use in load control programs that accelerate charging infrastructure deployment for their customers.<sup>771</sup>

EPA notes that it regards our analysis of adequacy and timeliness of distribution grid buildout as conservative, since it (intentionally) does not account for these innovative measures undertaken by some utilities; nor does it consider other than basic mitigative measures that BEV purchasers can undertake to reduce demand. Even with this conservative approach, we found that the rule affords adequate lead time for such buildout. We note that our analysis was informed significantly by studies from, and

evaluate the extent to which LCMS can be used to “support distribution reliability and safety, reduce grid upgrade costs, and reduce delays to customers obtaining interconnection and utility power service.” SCE states that prior CPUC decisions have expressed clear support for this technology and SCE is commencing the LCMS Pilot immediately Southern California Edison. “Establishment of Southern California Edison Company's Customer-Side, Third Party Owned, Automated Load Control Management Systems Pilot”. November 2023. Available online: [https://edisonintl.sharepoint.com/teams/Public/TM2/Shared%20Documents/Public/Regulatory/Filings-Advice%20Letters/Pending/Electric/ELECTRIC\\_5138-E.pdf?CT=1704322883028&OR=ItemsView](https://edisonintl.sharepoint.com/teams/Public/TM2/Shared%20Documents/Public/Regulatory/Filings-Advice%20Letters/Pending/Electric/ELECTRIC_5138-E.pdf?CT=1704322883028&OR=ItemsView).

<sup>771</sup> UL LLC, January 11, 2024. “UL 3141: Outline for Investigation of Power Control Systems.” Available online: [https://www.shopulstandards.com/ProductDetail.aspx?productId=UL3141\\_1\\_O\\_20240111](https://www.shopulstandards.com/ProductDetail.aspx?productId=UL3141_1_O_20240111).

discussions with, the Department of Energy.

We have also carefully considered the adequacy of lead time to procure minerals critical to battery production, for supply chains respecting those minerals to be resilient enough to support battery production, and for sufficiency of battery production. We have found that there is sufficient lead time within the rule's timeframe respecting all of these. See section II.D.2.c.ii of this preamble, and RTC section 17.2. Our findings here are likewise supported by DOE studies, and by our consultation with the DOE.

Purchasers of FCEVs will need to consider how they will obtain hydrogen to refuel the vehicles. Our assessment of hydrogen infrastructure and costs associated with refueling are in sections II.D.3.v, II.E.5.ii, and II.F.4 of this preamble, RIA Chapter 1, and RIA Chapter 2. We expect significant private investment as a result of public investment through BIL and IRA in the coming years. In the final rule, we project that hydrogen consumption from FCEVs would be a small proportion (less than 1 percent) of total hydrogen expected to be produced through 2030 in the United States, as discussed in RIA Chapter 1.8.3.4. After evaluating the existing and projected future hydrogen refueling infrastructure,<sup>772</sup> we considered FCEV technologies only in the MY 2030 and later timeframe to better ensure we have provided adequate time for early market infrastructure development and because we expect that projected refueling needs in the technology packages can be met by MY 2030, as discussed also in RIA Chapter 2.1.

Giving consideration to these factors, our analysis for the potential compliance pathway supports that there is sufficient lead time to meet the final standards, which manufacturers may comply with through application of BEV technologies, FCEV technologies, or further improvements to ICE vehicles (which can include additional technologies like PHEV technologies or other potential advanced technologies like H2–ICE powered vehicles) to their fleets. As just discussed, we also believe that there will be sufficient corresponding infrastructure to support technologies under our modeled potential compliance pathway, and that availability of critical minerals and supply chains will not be a constraining factor. To further demonstrate the

<sup>772</sup> U.S. Department of Energy. “Pathways to Commercial Lifftoff: Clean Hydrogen”. March 2023. Available online: <https://lifftoff.energy.gov/wp-content/uploads/2023/03/20230320-Lifftoff-Clean-H2-vPUB.pdf>.

performance-based nature of the final Phase 3 standards, we also included additional examples of compliance pathway's technology packages in section II.F.4 that support the feasibility of the final standards. In this final rule, we also considered but did not adopt alternative standards that would have been supported by technology packages with a slower phase-in of CO<sub>2</sub> emission-reducing technologies, including a slower phase in of HD ZEV technologies in the projected technology packages, as described and for the reasons discussed in section II.H.

Additionally, while we believe there is sufficient time for the charging and refueling infrastructure to develop for the reasons explained in this section, EPA recognizes that under the potential compliance pathway in this final rule such infrastructure for BEVs and FCEVs is important for the success of the increasing development and adoption of these technologies. EPA carefully considered that there are significant efforts already underway to develop and expand heavy-duty electric charging and hydrogen refueling infrastructure both at the local, state and Federal government level as well as from private industry, as discussed in RIA Chapters 1 and 2 and this section II. Those are important early actions that will support the increase in ZEV charging and refueling infrastructure needed for the future growth of ZEV technology of the magnitude EPA is projecting in this rule's technology packages. As discussed in section II.B.2.iii, EPA has a vested interest in monitoring industry's performance in complying with mobile source emission standards, including the highway heavy-duty industry, and is committing to do so for Phase 3. Monitoring the availability of supporting infrastructure is a critical element of that post-promulgation effort by EPA.

#### 4. Additional Example Compliance Pathway Technology Packages To Support the Final Standards

While the potential compliance pathway's technology packages that include both vehicles with ICE and ZEV technologies discussed in section II.F.1 and RIA Chapter 2.10 support the feasibility of the final standards and was modeled for rulemaking purposes, there are many other examples of possible compliance pathways for meeting the final standards that do not involve the widespread adoption of BEV and FCEV technologies. In this section, and RIA Chapter 2.11, we provide further support for the feasibility of the final standards by describing examples of additional potential compliance

pathways that are based on nationwide production volumes, including compliance pathways that involve only technologies for vehicles with ICE across a range of electrification (*i.e.*, without producing additional ZEVs to comply with this rule).

In this section, we discuss our analysis for the technologies included in the additional example compliance pathways of the impacts on reductions of GHG emissions; the technical feasibility and technology effectiveness; the lead time necessary to implement the technologies; costs to manufacturers; and willingness to purchase (including purchaser costs and payback). In short, EPA finds that, even without manufacturers producing additional ZEVs to comply with this rule, it would be technologically feasible to meet the final standards in the lead time provided and taking into consideration compliance costs. Regarding reductions of GHG emissions, these additional example potential compliance pathways meet the final Phase 3 MY 2027 through MY 2032 and later CO<sub>2</sub> emission standards, and therefore achieve the same level of vehicle CO<sub>2</sub> emission reductions and downstream CO<sub>2</sub> emission reductions as presented in preamble section V and RIA Chapter 4. Regarding technical feasibility and lead time, depending on the technology, we determined that either no further development of the technology is required (only further application) or that the technology is technically feasible and being actively developed by manufacturers to be commercially available for MY 2027 and later, and that there is sufficient lead time to deploy it. Similar to the approach we considered for BEVs and FCEVs in this preamble section II, for relevant technologies we also included a phased approach to provide lead time to meet the corresponding charging and refueling infrastructure needs under the final rule's additional example potential compliance pathways. Regarding costs of compliance, consistent with our Phase 2 assessment, we conclude that the estimated costs for all model years are reasonable for one of the additional example potential compliance pathways, for example based on our estimate that the MY 2032 fleet average per-vehicle cost to manufacturers by regulatory group will be \$3,800 for LHD; \$7,600 for MHD vocational vehicles; and \$7,700 for HHD vocational vehicles, and range between \$10,300 for day cab tractors and \$10,400 for sleeper cab tractors. For another additional example potential compliance pathway, which we developed and assessed because

manufacturers may choose to offer technologies (such as PHEVs) that have a higher projected upfront cost but also have a shorter payback period, we estimated higher costs of compliance (*e.g.*, approximately 18 percent of the price of a new tractor for MY 2032) and conclude these costs are also reasonable here given consideration of the corresponding business case for manufacturers to successfully deploy these technologies when considering willingness to purchase, including the payback period of these technologies and the IRA purchaser tax credits for PHEVs. Regarding our assessment of impacts on purchasers and willingness to purchase, the technologies we assessed generally pay back within 10 years or less. As we explain elsewhere in this preamble section II, businesses that operate HD vehicles are under competitive pressure to reduce operating costs, which should encourage purchasers to identify and adopt vehicle technologies that provide a reasonable payback period. For H2-ICE tractors, our assessment is that the operating costs exceed the operating costs of ICE tractors, but there may be other reasons that purchasers would consider this technology such as that the vehicles emit nearly zero CO<sub>2</sub> emissions at the tailpipe, the low engine-out exhaust emissions from H2-ICE vehicles provide the opportunity for efficient and durable after-treatment systems, and the efficiency of H2-ICE vehicles may continue to improve with time. Overall, the fact that such a fleet as the examples assessed in this section are possible underscores both the feasibility and the flexibility of the performance-based standards, and confirms that manufacturers are likely to continue to offer vehicles with a diverse range of technologies, including advanced vehicle with ICE technologies as well as ZEVs for the duration of these standards and beyond.

The vehicles considered in these additional pathways include a suite of technologies ranging from improvements in aerodynamics and tire rolling resistance in ICE tractors, to the use of lower carbon fuels like CNG and LNG, to hybrid powertrains (HEV and PHEV) and H2-ICE. As described in this section, these technologies either exist today or are actively being developed by manufacturers to be commercially available for MY 2027 and later.

This section presents our analysis of the effectiveness of reducing CO<sub>2</sub> emissions, the associated lead time, and the technology package costs for the technologies considered in these additional possible pathways in preamble sections II.F.4.i and II.F.4.ii

(we discuss the technologies themselves in preamble section II.D.1). We then created technology packages based on adoption rates of aggregated individual technologies into three scenarios for MYs 2027, 2030, and 2032 that represent additional example potential compliance pathways that further support the feasibility of the final standards in preamble section II.F.4.iii. The technology packages and adoption rates include a mix of vehicles with ICE technologies. For example, the additional example potential compliance pathways include some vocational vehicles with the technology package that supported the Phase 2 MY 2027 CO<sub>2</sub> vocational vehicle emission standards (shown in Table II–4 in preamble section II.D.1, and that include technologies such as low rolling resistance tires; tire inflation systems; efficient engines, transmissions, and drivetrains; weight reduction; and idle reduction technologies) as well as additional natural gas engine, H<sub>2</sub>–ICE vehicle, hybrid powertrain, and PHEV technologies for vocational vehicles. For another example, the additional example potential compliance pathways include tractors with further

aerodynamic and tire improvements in addition to the technology package that supported the Phase 2 MY 2027 CO<sub>2</sub> tractor emission standards (shown in Table II–3 in preamble section II.D.1, and that include technologies such as improved aerodynamics; low rolling resistance tires; tire inflation systems; efficient engines, transmissions, drivetrains, and accessories; and extended idle reduction for sleeper cabs) as well as additional natural gas engine, H<sub>2</sub>–ICE vehicle, hybrid powertrain, and PHEV technologies for tractors. The technology packages also include our projected reference case (see RIA Chapter 4) ZEV adoption rates. Scenario 1 meets the MY 2032 standards with higher adoption of vehicles with H<sub>2</sub>–ICE technology. Scenario 2 meets the MY 2032 standards with higher adoption of PHEV technology. Finally, we assessed the manufacturer costs under these additional example potential compliance pathways, in preamble section II.F.4.iv, and purchaser costs and payback in preamble section II.F.4.v.<sup>773</sup> The vehicle manufacturers that certified to EPA standards for MY 2022 and/or MY 2023 are those listed in

Table II–38.<sup>774</sup> Manufacturers used a wide variety of technologies to meet the standards. The manufacturer names with ‘\*’ indicate that they have EPA certifications for vehicles that use natural gas. The manufacturer names with ‘–’ indicate they have EPA certifications for vehicles with hybrid powertrains. Since the public certification data for these MYs doesn’t identify which vehicles are certified with hybrid powertrains, we relied on information identified in Chapter 1.4 of the RIA. As for hydrogen-fueled internal combustion engines, no manufacturers have certified to EPA standards for MY 2022 with the technology, however a number of manufacturers have indicated that they are developing an engine that can run on hydrogen.<sup>775</sup> Finally, there are a number of manufacturers that have certified ICE vehicles that have projected CO<sub>2</sub> FEL that are lower than the Phase 2 MY 2027 standards. The manufacturer names with ‘#’ indicate that they have one or more vehicles families that currently meet the Phase 2 MY 2027 standards, and which we thus project will have CO<sub>2</sub> FEL that are lower than the Phase 2 MY 2027 standards in MY 2027.

**Table II-38 Vehicle Manufacturers Certified to EPA HDV Emission Standards in MY 2022**

ARBOC Specialty Vehicles, LLC *	General Motors LLC #	Rosenbauer Motors LLC
Autocar, LLC *#	Gillig LLC *^	SEA Electric
Battle Motors, Inc. *	Global Environment Product Inc *	Seagrave Fire Apparatus LLC
Blue Bird Body Company *	Grove US LLC	Spartan Fire LLC
BYD Auto Industry Company Ltd	Hino Motors, Ltd #	Temsa Skoda Sabanci Ulasim Araclari A.S. #
Daimler Coaches North America *	HME Inc	Terex Corporation
Daimler Truck North America LLC #	Isuzu Motors Limited #	The Shyft Group
Dennis Eagle Inc *	Motor Coach Industries *	Tiffin Motor Homes Inc
Eldorado National-California Inc *	Navistar, Inc #	Van Hool N.V.
Envirotech Drive Systems Inc	New Flyer of America, Inc *^	Vicinity Motor (Bus) Corp *
E-One Inc	Nikola Corporation	Volvo Group Trucks, Technology, Powertrain Engineering, a Division of Mack Trucks *^#
FCA US LLC #	Oshkosh Corporation ^	XOS, Inc
Ferrara Fire Apparatus Inc	PACCAR Inc *#	Zeus Electric Chassis, Inc
Ford Motor Co #	Proterra Operating Company, Inc	

\* \* indicate that they have EPA certifications for vehicles that use natural gas.

^ ^ indicate they have EPA certifications for vehicles with hybrid powertrains.

# # indicate that they have one or more vehicles families that currently meet the Phase 2 MY 2027 standards

<sup>773</sup> We also developed another set of technology packages that do not include our projected reference case ZEV adoption rates (*i.e.*, they are potential compliance pathways that support the feasibility of the standards with only technologies for vehicles with ICE, with zero nationwide adoption of ZEV technologies) which is presented in RIA Chapter 2.11.

<sup>774</sup> U.S. EPA. “Heavy-Duty Highway Gasoline and Diesel Certification Data (Model Years: 2015—Present)” February 2024. Available online: [www.epa.gov/compliance-and-fuel-economy-data/annual-certification-data-vehicles-engines-and-equipment](http://www.epa.gov/compliance-and-fuel-economy-data/annual-certification-data-vehicles-engines-and-equipment).

<sup>775</sup> Cummins. “Cummins to Reveal Zero-Carbon H<sub>2</sub>–ICE Concept Truck at IAA Expo Powered by the B6.7H Hydrogen Engine”. September 13, 2022. Available Online: <https://www.cummins.com/news/releases/2022/09/13/cummins-reveal-zero-carbon-h2-ice-concept-truck-iaa-expo-powered-b67h>.

i. Technology Effectiveness and Lead Time

We evaluated the potential for lower CO<sub>2</sub> emissions from further aerodynamic and tire improvements to ICE tractors as well as natural gas engine, H<sub>2</sub>-ICE vehicle, hybrid powertrain, and PHEV technologies for both vocational vehicles and tractors, as discussed in section II.D.1 of this preamble. See section II.D.1 for further discussion of EPA’s assessment that these technologies are technically feasible.

a. Aerodynamic and Tire Improvements for Tractors

In these additional technology pathways, for further aerodynamic and tire improvements to the technology packages that supported the Phase 2 MY 2027 CO<sub>2</sub> emission standards we evaluated technologies to reduce CO<sub>2</sub> emissions from ICE tractors. Tractors with ICEs have the potential to have lower CO<sub>2</sub> emissions than required by the Phase 2 MY 2027 CO<sub>2</sub> emission standards by further reducing the aerodynamic drag of the tractor and by reducing the tire rolling resistance. These technologies are already being used by manufacturers to certify their tractors to the Phase 2 standards. Therefore, EPA assessed this potential technology package applicable to tractors through a combination of aerodynamic improvements and lower rolling resistant tires.

For this Phase 3 analysis, consistent with our approach in Phase 2 for evaluating technology effectiveness, we evaluated the technologies to reduce aerodynamic drag, as discussed in preamble section II.D.1.i. The aerodynamic drag performance is

determined through aerodynamic testing. The results of the test determine the aerodynamic bin (Bin I through VII) and therefore input to GEM that is used to determine a vehicle’s CO<sub>2</sub> emissions. The aerodynamic Bin I level represents tractor bodies which prioritize appearance or special duty capabilities over aerodynamics. These Bin I tractors incorporate few, if any, aerodynamic features and may have several features which detract from aerodynamics, such as bug deflectors, custom sunshades, B-pillar exhaust stacks, and others. Bin V represents the most aerodynamic MY 2022 tractors.

The aerodynamic technology already existed for the tractors to achieve Bin IV and Bin V performance in MY 2021, therefore, our assessment is that there is sufficient lead time for tractor manufacturers to increase application of these aerodynamic designs by MY 2027 and to produce more low and mid roof tractors at a Bin IV level of performance and more high roof tractors at a Bin V performance. Because no further development of aerodynamic technology is required, only further application of the technologies, under the additional example potential compliance pathways our assessment is that there is sufficient lead time to include in those technology packages the entire tractor aerodynamic performance to these levels.

For this Phase 3 analysis, we also evaluated technologies to reduce tire rolling resistance on tractors, as discussed in section II.D.1.ii of this preamble. In Phase 2, we developed four levels of tire rolling resistance. The baseline tire rolling resistance level represents the average tire rolling resistance on tractors in 2010. Levels 1,

2, and 3 are lower rolling resistance tires, with each level representing approximately 15 percent lower rolling resistance than the previous level. In the MY 2021 certification data, we found that the average rolling resistance of the steer tires installed on the day cab and sleeper cab tractors was approximately Level 2. The average rolling resistance of the drive tires installed on day cab and sleeper cab tractors was between Level 1 and Level 2 performance. The exception was for high roof sleeper cabs where the average drive tire rolling resistance was at Level 2. The lowest rolling resistance tires used on each of the day cab and sleeper cab configurations was 4.7 N/kN and 4.8 N/kN ton rolling resistance of the steer and drive tires, respectively, which is better than the Level 3 performance. Our assessment for the additional example potential compliance pathways is that tractor tire rolling resistance can shift to a 50/50 split of Level 2 and Level 3 tire rolling resistance for both the steer and drive tires in MY 2027

We used the technology effectiveness inputs and technology adoption rates discussed in this section of the preamble for aerodynamics and tire rolling resistance, along with the other vehicle technologies used in the Phase 2 MY 2027 technology package to demonstrate compliance with the Phase 2 MY 2027 tractor standards to develop the GEM inputs for each subcategory of Class 7 and 8 tractors. The set of GEM inputs are shown in Table II-39. Note that we have analyzed one technology pathway for each level of stringency, but tractor manufacturers are free to use any combination of technologies that meet the standards on average.

**BILLING CODE 6560-50-P**

**Table II-39 GEM Inputs for Tractor ICE Vehicle Technologies that Achieve a 4% CO<sub>2</sub> Reduction Relative to the Phase 2 MY 2027 Standards**

Class 7			Class 8					
Day Cab			Day Cab			Sleeper Cab		
Low Roof	Mid Roof	High Roof	Low Roof	Mid Roof	High Roof	Low Roof	Mid Roof	High Roof
<b>Engine Fuel Map</b>								
2027MY 11L Engine 350 HP	2027MY 11L Engine 350 HP	2027MY 11L Engine 350 HP	2027MY 15L Engine 455 HP	2027MY 15L Engine 455 HP	2027MY 15L Engine 455 HP	2027MY 15L Engine 455 HP	2027MY 15L Engine 455 HP	2027MY 15L Engine 455 HP
<b>Aerodynamics (C<sub>d</sub>A in m<sup>2</sup>)</b>								
4.75	5.85	5.70	4.75	5.85	5.20	4.75	5.85	4.90
<b>Steer Tire Rolling Resistance (CRR in kg/metric ton)</b>								
5.3	5.3	5.3	5.3	5.3	5.3	5.3	5.3	5.3
<b>Drive Tire Rolling Resistance (CRR in kg/metric ton)</b>								
5.5	5.5	5.5	5.5	5.5	5.5	5.5	5.5	5.5
<b>Extended Idle Reduction Weighted Effectiveness</b>								
N/A	N/A	N/A	N/A	N/A	N/A	3%	3%	3%
Transmission = 10 speed Manual Transmission Gear Ratios = 12.8, 9.25, 6.76, 4.90, 3.58, 2.61, 1.89, 1.38, 1.00, 0.73 Drive Axle Ratio = 3.21 for day cabs, 3.16 for sleeper cabs								
<b>6x2 Axle Weighted Effectiveness</b>								
N/A	N/A	N/A	0.6%	0.6%	0.6%	0.6%	0.6%	0.6%
Transmission Type Weighted Effectiveness = 1.6%								
<b>Neutral Idle Weighted Effectiveness</b>								
0.2%	0.2%	0.2%	0.2%	0.2%	0.2%	0.03%	0.03%	0.03%
Direct Drive Weighted Effectiveness = 1.0%								
Transmission Efficiency Weighted Effectiveness = 0.7%								
Axle Efficiency Improvement = 1.6%								
Air Conditioner Efficiency Improvements = 0.3%								
Accessory Improvements = 0.2%								
Predictive Cruise Control = 0.8%								
Automatic Tire Inflation Systems = 0.4%								
Tire Pressure Monitoring System = 0.7%								

The results from GEM for this technology package are shown in Table II-40. As shown, this technology

package within the additional example potential compliance pathway achieves

4 percent lower CO<sub>2</sub> emissions than the Phase 2 MY 2027 tractor standards.

**Table II-40 GEM Results for Phase 3 Additional Compliance Pathway for Tractors**

Class 7			Class 8					
Day Cab			Day Cab			Sleeper Cab		
Low Roof	Mid Roof	High Roof	Low Roof	Mid Roof	High Roof	Low Roof	Mid Roof	High Roof
<b>Phase 2 MY 2027 Standards (g CO<sub>2</sub>/ton-mile)</b>								
96.2	103.4	100.0	73.4	78.0	75.7	64.1	69.6	64.3
<b>Phase 3 MY 2027 Additional Pathway GEM Results (g CO<sub>2</sub>/ton-mile)</b>								
91.4	98.7	95.2	70.1	74.7	72.6	61.2	66.6	61.9

**BILLING CODE 6560-50-C**

In conclusion, under the additional example compliance pathways we project that improvements in ICE vehicle technologies above and beyond the improvements needed to meet the Phase 2 MY 2027 standards will be

available for manufacturers to use for tractors and estimate use of those improvements would result in an additional emissions reduction of 4 percent.

We note that in these additional pathways, like in our modeled

compliance pathway, the ICE vocational vehicles portion of the pathway emit at the Phase 2 MY 2027 level. Therefore, we did not add any additional technologies or costs associated with the vocational ICE vehicles with Phase 2 MY 2027 technologies. We also note

that the Phase 2 standards for vocational vehicles did not include the use of aerodynamic technologies and were projected to be met with the use of improvements in tire rolling resistance and other technologies. Thus, the corresponding ICE vehicle technology package used within the additional example compliance pathway analysis for a portion of the vocational vehicles encompasses the same set of technologies used to demonstrate compliance with the Phase 2 MY 2027 standards, as described in section II.D.1.

b. Natural Gas Fueled Internal Combustion Engines

To estimate the technology effectiveness of natural gas-fueled engines compared to diesel fueled engines in the Phase 3 additional example potential compliance pathways, we used the publicly available MY 2023 heavy-duty engine certification data for CO<sub>2</sub> emissions.<sup>776</sup> We compared GHG certification data between three engines of similar displacement, power ratings, and

intended model application fueled on CNG and conventional diesel. Family Certification CO<sub>2</sub> Levels for the transient Federal Test Procedure (FTP) and Supplemental Emission Test (SET) duty cycles were compared to determine the CO<sub>2</sub> reductions possible by applying natural gas engine technology, as shown in Table II–41. The comparison shows that natural gas engine technology could achieve CO<sub>2</sub> reductions up to 7 percent for vocational vehicles and 6 percent for tractors compared to a similar diesel fueled ICE.

Table II-41 Heavy-Duty Engine CO<sub>2</sub> Comparison

	CNG FTP CO <sub>2</sub> (g/hp·hr)	CNG SET CO <sub>2</sub> (g/hp·hr)	Diesel FTP CO <sub>2</sub> (g/hp·hr)	Diesel SET CO <sub>2</sub> (g/hp·hr)	% Average CO <sub>2</sub> Reduction
Vocational	514	424	524	478	7%
Tractor	501	427	518	470	6%

We also considered the availability of the natural gas fueling stations. According to the U.S. Department of Energy there are 1,464 compressed natural gas and liquified natural gas filling stations in the United States.<sup>777</sup> Of these stations, approximately 90 percent of them are CNG stations and 10 percent are LNG stations. These stations are a combination of publicly accessible (783) and privately operated (681). Of the publicly accessible fueling stations, all will accommodate Class 3 through 5 HD vehicles and 1,246 will accommodate HD Class 5 through 8 vehicles. After evaluating the existing, and taking into account potential future, natural gas refueling infrastructure, similar to the approach we considered for BEVs and FCEVs in this preamble section II to ensure adequate lead time for corresponding infrastructure, we determined that there was adequate lead time for 5 percent adoption of natural gas vehicles in the additional example potential compliance pathways based on our balancing that these technologies are currently available and used as well as the additional consideration of the corresponding infrastructure needed for the level of adoption under these pathways by MY 2027.

c. Hydrogen-Fueled Internal Combustion Engines

Since neat hydrogen fuel does not contain any carbon, H<sub>2</sub>–ICE fueled with neat hydrogen produce zero HC, CH<sub>4</sub>, CO, and CO<sub>2</sub> engine-out emissions.<sup>778</sup> However, as explained in section III.C.2.viii, we recognize that, like CI ICE, there may be negligible, but non-zero, CO<sub>2</sub> emissions at the tailpipe of H<sub>2</sub>–ICE that use SCR and are fueled with neat hydrogen due to contributions from the aftertreatment system from urea decomposition; thus, for purposes of 40 CFR part 1036 we are finalizing an engine testing default CO<sub>2</sub> emission value (3 g/hp-hr) option (though manufacturers may instead conduct testing to demonstrate that the CO<sub>2</sub> emissions for their engine is below 3 g/hp-hr). Under this final rule, consistent with treatments of such contributions from the aftertreatment system from urea decomposition for diesel ICE vehicles, we are not including such contributions as vehicle emissions for H<sub>2</sub>–ICE vehicles.<sup>779</sup> Thus, H<sub>2</sub>–ICE technologies that run on neat hydrogen, as defined in 40 CFR 1037.150(f) and discussed in section III.C.3.ii of the preamble, have HD vehicle CO<sub>2</sub> emissions that are deemed to be zero for purposes of 40 CFR part 1037. Therefore, the technology effectiveness

(in other words CO<sub>2</sub> emission reduction) for the vehicles that are powered by this technology is 100 percent.

The lead time consideration for H<sub>2</sub>–ICE vehicles consists of two parts. The first part is the engine technology design and development, along with the integration of the engine, aftertreatment, and fuel storage integration into the vehicle. The second part is the hydrogen refueling infrastructure availability.

An H<sub>2</sub>–ICE is very similar to existing ICEs and engine manufacturers can leverage the extensive technical expertise they have developed with existing products. Many H<sub>2</sub>–ICE engine components can be produced using an engine manufacturer’s existing tooling and manufacturing processes. Similarly, H<sub>2</sub>–ICE vehicles can be built on the same assembly lines as other ICE vehicles, by the same workers and with many of the same component suppliers. For example, Cummins has announced the launch of a fuel-agnostic combustion engine X10 for MY 2026 that can run on hydrogen fuel.<sup>780</sup> Many design aspects of the integration of a H<sub>2</sub>–ICE into a vehicle can be done in parallel with the H<sub>2</sub>–ICE ramp up to the production launch of an engine. However, there may be final validation vehicle development steps that will require the final H<sub>2</sub>–ICE and therefore may take an

<sup>776</sup> U.S. EPA. “Annual Certification Data for Heavy-Duty Vehicles”. January 2023. Available Online: <https://www.epa.gov/system/files/documents/2023-01/heavy-duty-gas-and-diesel-engines-2015-present.xlsx>.

<sup>777</sup> Department of Energy, Energy Efficiency and Renewable Energy, Alternative Fuels Data Center, Alternative Fuel Station Locator. February 2024.

Available online: <https://afdc.energy.gov/stations/#/find/nearest?fuel=CNG&country=US>.

<sup>778</sup> Note, NO<sub>x</sub> and PM emission testing is required under existing 40 CFR part 1036 for engines fueled with neat hydrogen.

<sup>779</sup> The results from the fuel mapping test procedures prescribed in 40 CFR 1036.535 are fuel consumption values, therefore the CO<sub>2</sub> emissions

from urea decomposition is not included in the results.

<sup>780</sup> Cummins. “Cummins Announces New X10 Engine, Next in The Fuel-Agnostic Series, Launching in North America in 2026.” February 2023. Available Online: <https://www.cummins.com/news/releases/2023/02/13/cummins-announces-new-x10-engine-next-fuel-agnostic-series-launching-north>.

additional year after the launch of an H2-ICE. Therefore, from the technology development perspective, we project H2-ICE technology will be available in MYs 2027 and later.

The discussion in RIA Chapter 1.8.3 details our assessment of hydrogen refueling infrastructure. After evaluating the existing and projected future hydrogen refueling infrastructure and similar to the approach we considered for publicly-charged BEVs and FCEVs in this preamble section II, we considered H2-ICE vehicle technology only in the MY 2030 and later timeframe for the additional example potential compliance pathways, to better ensure that our additional example potential compliance pathways provide adequate time for early hydrogen market infrastructure development. We included the H2-ICE technology in the additional compliance pathway relative to the reference case in MY 2031 and later, which provides nearly seven years of lead time for the H2 refueling infrastructure buildout to phase in.

d. Hybrid and Plug-in Hybrid Powertrains

As discussed in section II.D.1.v, hybrid powertrains have lower CO<sub>2</sub> emissions than ICE powertrains due to a combination of regenerative braking and the ability to optimize the ICE operation within the hybrid powertrain system. For this Phase 3 analysis we used the approach described in Chapter 2.2.2.1.3 of the RIA to determine the effectiveness of hybrids based on the amount of braking energy recovered from regenerative braking. In summary, to calculate percent energy recovery available, we estimated the braking energy and divided by the total tractive energy (*i.e.*, the energy required to move the vehicle) for each drive cycle and then weighted the results using the respective GEM test cycle weighting factors. We then multiplied these values by the weighted energy consumption per mile to get energy recovered per mile from regenerative braking. The average regeneration energy as a percentage of total tractive energy was 10 percent and 5 percent, for vocational vehicles and tractors, respectively. For both tractors and vocational vehicles, we project that hybrid technology can achieve an additional 5 percent of effectiveness by optimizing how the engine is operated. For example, the engine could be operated in the minimum brake-specific fuel consumption region of the engine more often in a hybrid powertrain. In addition, the electric motor could be used to limit engine transient operation, or the engine could be downsized. This

leads to an overall CO<sub>2</sub> emission reduction of 15 percent for vocational vehicle hybrids and 10 percent for tractor hybrids.

For hybrid electric vehicles, the projected effectiveness is further supported by powertrain testing that was conducted by Eaton at Argonne National Laboratory. The testing was performed with a Cummins X15 engine and three transmissions. The transmissions were an Eaton P2/P3 hybrid, Eaton Endurant, and an Allison 4500 RDS. For each of the three powertrain configurations, the test procedures prescribed in 40 CFR 1036.545 were followed to generate powertrain fuel maps. Each of these fuel maps were input into GEM Version 3.5.1 to determine gCO<sub>2</sub>/ton-mile emissions from a number of representative vehicle configurations. For the heavy heavy-duty vocational vehicles, the average CO<sub>2</sub> emission reductions were 22, 8, and 25 percent for multi-purpose, regional, and urban regulatory subcategories respectively. The average CO<sub>2</sub> reductions for day cab and sleeper cab tractors was 9 percent. The data from the powertrain tests supports the estimated CO<sub>2</sub> emission reduction of 15 percent for vocational vehicle hybrids, as it is expected that vocational vehicle hybrids will be certified as multi-purpose or urban. The data from the powertrain tests also supports the estimated CO<sub>2</sub> emission reduction of 10 percent for tractor hybrids, since many of the individual tractors had greater than 10 percent CO<sub>2</sub> emission reduction, with the average at 9 percent.

In addition, other studies have also shown CO<sub>2</sub> emission reductions from heavy-duty hybrid vehicles. For example, a New Flyer hybrid transit bus achieves 10–29 percent reduction, depending on route.<sup>781</sup> Similarly, a NovaBus hybrid transit bus found up to 30 percent reduction in CO<sub>2</sub> emissions at speeds ranging between 9–18 mph.<sup>782</sup> A NREL report of a reduction of 75 percent CO<sub>2</sub> in idle emissions during PTO use<sup>783</sup> where idle operation is over 30 percent of vehicle operating time and uses 10 percent of the fuel.<sup>784</sup> A study

<sup>781</sup> New Flyer. “Hybrid-electric mobility.” Available online: <https://www.newflyer.com/bus/xcelstior-hybrid/>.

<sup>782</sup> NovaBus. “Nova LFS HEV”. Available online: [https://novabus.com/blog/bus/lfs\\_hev/](https://novabus.com/blog/bus/lfs_hev/).

<sup>783</sup> Ragatz, Adam, Jonathan Burton, Eric Miller, and Matthew Thornton. “Investigation of Emissions Impacts from Hybrid Powertrains” National Renewable Energy Lab. January 2020. Available online: <https://www.nrel.gov/docs/fy20osti/75782.pdf>.

<sup>784</sup> Konan, Arnaud, Adam Duran, Kenneth Kelly, Eric Miller, and Robert Prohaska. “Characterization of PTO and Idle Behavior for Utility Vehicles”.

with a Pierce Manufacturing hybrid fire truck showed 1,500 gallons of diesel saved in one month which also leads to a reduction in CO<sub>2</sub> emissions.<sup>785</sup>

Hybrid technology is currently being used on heavy-duty vehicles. RIA Chapter 1.4.5 details the HD truck and bus models that are currently offered as hybrid vehicles. As shown, both Allison and BAE offer heavy-duty hybrid systems for use in vehicles. Our assessment, based on currently available hybrid technology that is being produced in vehicles today, is that there is adequate lead time for manufacturers to increase the adoption of the technology for LHD and MHD vocational vehicles in MY 2027 and for HHD vocational vehicles and tractors in MY 2030 to the adoption levels included in the additional pathways.

Plug-in hybrid electric vehicles run on both electricity and fuel. The utility factor is the fraction of miles the vehicle travels in electric mode relative to the total miles traveled. The percent CO<sub>2</sub> emission reduction is directly related to the utility factor. The greater the utility factor, the lower the tailpipe CO<sub>2</sub> emissions from the vehicle. The utility factor depends on the size of the battery and the operator’s driving habits. For PHEVs, we project that for MY 2027 and MY 2032 tractors, a CO<sub>2</sub> emission reduction (effectiveness) of 30 percent is achievable by adding a high-voltage battery that could achieve a utility factor of 22 percent. For MY 2027 vocational vehicles, we project an effectiveness of 30 percent could be achieved by adding a high-voltage battery with a utility factor of 18 percent. For MY 2030 vocational vehicles, we project an effectiveness of 50 percent could be achieved by adding a high-voltage battery with a utility factor of 41 percent. With utility factors between 18 to 41 percent, a significantly smaller battery would be needed for a PHEV in comparison to the battery needed for a corresponding battery electric vehicle.

For heavy-duty PHEVs, the projected effectiveness is further supported by powertrain testing that was conducted by Eaton at Argonne National Laboratory. To evaluate the emissions reductions of a plug-in hybrid powertrain, Eaton used a combination of GEM simulations and powertrain test results. The results of the analysis showed that a vocational vehicle with a

National Renewable Energy Lab. Available online: <https://www.nrel.gov/docs/fy17osti/66747.pdf>.

<sup>785</sup> Pierce. “Pierce Volterra Platform of Electric Vehicles”. Available online: <https://www.piercemfg.com/electric-fire-trucks/pierce-volterra>.



plug-in hybrid powertrain could reduce CO<sub>2</sub> emission by 52 percent.<sup>786</sup>

In our lead time assessment for PHEVs, we believe it will take longer for vehicle manufacturers to integrate this technology into vehicles than it will for hybrid technologies. We determined that approximately 3–4 years would be necessary to develop this technology. Therefore, we conservatively included PHEVs in limited applications (HHD vocational vehicle and day cab tractors) beginning in MY 2030 and included a scenario in MY 2032 with and without PHEVs in the technology packages that also include our projected reference case ZEV adoption rates. PHEVs, like BEVs, require an external charging source to provide electricity to the vehicle. However, the recharging demand for a PHEV is much lower than

a comparable BEV. Therefore, most heavy-duty PHEVs could use Level 1 charging by plugging it into a standard 240 V outlet. Truck operators would have access to these outlets at depots and other businesses without having to require special installation of EVSE equipment. Operators would need to create access to such an outlet, but this would not be a constraining factor for lead time and such costs would be low for purchasers. Similar to the approach we considered for BEVs and FCEVs in this preamble section II, we determined there is adequate lead time to meet the projected charging infrastructure needs that correspond to the technology packages for the final rule’s additional example potential compliance pathways. Furthermore, because the

recharging demand for PHEVs will be lower than the levels for BEVs in our modeled potential compliance pathway, the demand on the grid would be less than assessed with our modeled potential compliance pathway discussed in preamble section II.D.2.iii.

e. Summary of the Technology Effectiveness

Table II–42 shows the summary of the technology effectiveness (percent CO<sub>2</sub> emission reduction) of each of the technologies discussed in this subsection relative to the Phase 2 MY 2027 standards.

Table II–42 Effectiveness of Technologies of Vehicles with ICE Relative to the MY 2027 Phase 2 Standards

**Table II-42 Effectiveness of Technologies of Vehicles with ICE Relative to the MY 2027 Phase 2 Standards**

Vehicle Type	Model Year	ICE Vehicle Improvements	Natural Gas ICE Vehicle	HEV	PHEV	H2 ICE Vehicle
Tractor	MY 2027	4%	6%	10%	30%	100%
	MY 2030	4%	6%	10%	30%	100%
	MY 2032	4%	6%	10%	30%	100%
Vocational	MY 2027	0%	7%	15%	30%	100%
	MY 2030	0%	7%	15%	50%	100%
	MY 2032	0%	7%	15%	50%	100%

ii. Technology Package Costs

In this section, we present the incremental technology package costs for each technology relative to the comparable baseline vehicles that meet the Phase 2 MY 2027 emission standards.<sup>787</sup>

a. ICE Vehicle Improvements

The costs for the additional aerodynamic and low rolling resistance tire technologies were developed based on the cost assessment in the Phase 2 final rule.<sup>788</sup> These technology costs developed for the Phase 2 analysis remain appropriate because the technologies are the same and the costs including learning through MY 2027. As discussed in RIA Chapter 2.11.2.1, the incremental technology package cost of increased application of aerodynamic technologies and low rolling resistance

tires is \$1,978 for sleeper cab tractors and \$1,715 for day cab tractors.

b. Natural Gas Fueled Internal Combustion Engines

EPA contracted FEV to conduct a technology and cost study for a variety of powertrains applicable to Class 4, 5, 7, and 8 heavy-duty vehicles.<sup>789</sup> FEV also costed three (15L for Class 8, 10L for Class 7, and 6.6L for Class 4/5) diesel ICE powertrains that would meet the emission standards as required by the Low NOx Rule and the Phase 2 CO<sub>2</sub> emission standards in MY 2027. These were used to calculate the incremental cost of the alternative powertrain to the comparable diesel ICE powertrain baseline, as described in RIA Chapter 2.11.2.2.

The costs presented in Table II–43 include both the direct and indirect costs of compliance for manufacturers and represent a market stable scenario

where the technologies are mature, which is appropriate because natural gas technologies have been used in the heavy-duty marketplace for decades. The costs represent the incremental costs of a spark-ignited (SI) CNG engine because that is the predominant technology being offered today in the heavy-duty market.<sup>790</sup>

One difference in costs between a CNG powertrain and the baseline diesel powertrain is the fuel ‘tank.’ A CNG vehicle requires pressurized fuel tanks typically made with carbon fiber in order to hold the fuel at required pressures of 250 bar. These tank types are much higher in cost than a tank to hold diesel fuel which does not require the capability to store fuel under pressure. The larger the vehicle and/or the longer the distance traveled per day dictates the number and size of the tanks required. Cost of tanks for the CNG Class 8 day cab and sleeper cab

<sup>786</sup> Sanchez, James. Memorandum to Docket EPA–HQ–OAR–2022–0985. “Eaton Hybrid Powertrain Results” February 2024.

<sup>787</sup> The costs presented in this section do not include the learning effects after MY 2027, and therefore are higher than they would be if they

included learning (*i.e.*, are conservative in the overestimating sense).

<sup>788</sup> U.S. EPA. Regulatory Impact Analysis Greenhouse Gas Emissions and Fuel Efficiency Standards for Medium- and Heavy-Duty Engines and Vehicles—Phase 2. Chapter 2. EPA–420–R–16–900. August 2016.

<sup>789</sup> FEV Consulting. “Heavy Duty Commercial Vehicles Class 4 to 8: Technology and Cost Evaluation for Electrified Powertrains—Final Report”. Prepared for EPA. March 2024.

<sup>790</sup> Cummins. Natural Gas Engine Portfolio. Available online: <https://mart.cummins.com/imagelibrary/data/assetfiles/0063969.pdf>.

tractor powertrains were estimated to be \$10,000-\$16,500.<sup>791</sup>  
 Another area of difference is in the aftertreatment required on CNG powertrains compared to a diesel. The current diesel powertrain contains a DOC, DPF, SCR and associated urea injection/mixing system. Spark-ignited CNG engines run stoichiometric combustion and therefore only require a

three-way catalyst to reduce HC, CO and NOx, similar to gasoline-fueled ICE vehicles. Engine-out PM from SI-CNG fueled vehicles meet the exhaust emission standards without additional aftertreatment. Therefore, spark-ignited CNG vehicles do not require a DPF, DOC, SCR or the DEF and urea mixing system and a significant cost reduction compared to the diesel powertrain

baseline is realized. Another cost reduction comes from the fuel injection system. The diesel system has a fuel injection system used to atomize the diesel fuel as it goes into the combustion chamber. These components are not needed on a gaseous fuel as it is already in combustible form.

**Table II-43 Summary of the MY 2027 and Later Incremental Costs for Natural Gas Fueled Vehicles (2022\$)**

Vehicle Type	Total
Light Heavy-Duty Vocational	\$ (7,163)
Medium Heavy-Duty Vocational	\$ (4,690)
Heavy Heavy-Duty Vocational	\$ (3,282)
Day Cab Tractors	\$ 75
Sleeper Cab Tractors	\$ 1,888

**c. Hydrogen-Fueled Internal Combustion Engines**

We used the same FEV cost study to develop the incremental technology costs for H2-ICE vehicles, as shown in Table II-44.<sup>792</sup>

As with CNG, a major difference between H2-ICE powertrains and the baseline diesel powertrain is the fuel ‘tank.’ The H2-ICE requires pressurized fuel tanks typically made with carbon fiber and many other considerations in order to hold the fuel at required pressures. The H2 tanks used in the FEV cost study are designed to store H2 at 700 bar so that they can hold sufficient hydrogen. These tank types are much

higher in cost than a tank to hold diesel fuel because the fuel is pressurized. The cost of the tanks on the Class 8 sleeper cab tractors can add on \$30,000 in low volumes to the H2-ICE powertrain costs.

Also similar to CNG, a significant cost decrease compared to the baseline powertrain is due to the difference in the aftertreatment required on H2-ICE fueled powertrains compared to the baseline diesel powertrain. The baseline diesel powertrain contains a DOC, DPF, SCR and an associated urea mixing/dosing system. These aftertreatment components work to reduce hydrocarbons, carbon monoxide, particulate matter and NOx,

respectively. Only SCR and DOC aftertreatment is required on a H2-ICE fueled with neat H2 in order to reduce NOx. In developing the aftertreatment cost for the H2-ICE, an exhaust gas heater was also included in order to reduce NOx at idle and during low power operation. Another cost decrease compared to the baseline powertrain comes from the fuel injection system. The baseline diesel system has a number of components to atomize the diesel fuel as it goes into the combustion chamber. These components are not needed on a H2-ICE because the H2 is a gaseous fuel in combustible form.

**Table II-44 Summary of the MY 2030 and Later Incremental Costs for Hydrogen Fueled ICE Vehicles (2022\$)**

Vehicle Type	Total
Light Heavy-Duty Vocational	\$ 3,872
Medium Heavy-Duty Vocational	\$ 14,100
Heavy Heavy-Duty Vocational	\$ 27,873
Day Cab Tractors	\$ 26,936
Sleeper Cab Tractors	\$ 44,919

**d. Hybrids and Plug-In Hybrid Powertrains**

To determine the hybrid powertrain costs, we relied on the Autonomie study results published with the 2023 DOE

VTO/HFTO Transportation Decarbonization Analysis.<sup>793</sup> The results include vehicle costs for conventional vehicles and parallel hybrid vehicles for each vehicle class.

RIA Chapter 2.11.2.4 describes the process for determining the incremental powertrain costs for each hybrid powertrain. The summary of the hybrid vehicle costs are in Table II-45.

<sup>791</sup> Caffrey, Cheryl. Memorandum to the docket EPA-HQ-OAR-2022-0985. “Alternative Powertrain Costs” February 2024.

<sup>792</sup> Caffrey, Cheryl. Memorandum to the docket EPA-HQ-OAR-2022-0985. “Alternative Powertrain Costs” February 2024.

<sup>793</sup> US Department of Energy. Available online: <https://anl.box.com/s/hv4kufocq3leoijt6v0wht2uddjuiff4andhttps://anl.box.com/s/oy04bje3ltc21r5py4bq1ed4s4bn0vo>.

**Table II-45 Summary of MY 2027 and Later Direct and Indirect Manufacturing Costs for Hybrid Electric Vehicles (2022\$)**

Vehicle Type	Direct Manufacturing Costs	Indirect Manufacturing Costs	Total
Light Heavy-Duty Vocational	\$5,617	\$2,359	\$7,976
Medium Heavy-Duty Vocational	\$8,436	\$3,543	\$11,979
Heavy Heavy-Duty Vocational	\$11,936	\$5,013	\$16,949
Day Cab Tractors	\$9,359	\$3,931	\$13,290
Sleeper Cab Tractors	\$11,324	\$4,756	\$16,080

The PHEV technology combines an ICE powertrain with a BEV powertrain. Therefore, we calculated the incremental costs of the PHEV technology using a similar approach as we did for BEVs and ICEVs in HD TRUCKS for each of the 101 vehicle types, as detailed in RIA Chapter 2.3.2 and 2.4.3. We used the same component costs for the ICE powertrain, except replaced the ICE accessory costs with the electrified accessory component costs used in BEVs. For the electrified portion of the PHEV, we also included

the electric motor, onboard charger, and power converter costs for a similar BEV. The key difference between the BEV and PHEV powertrain costs is due to the size of the battery. We reduced the size of the battery for the PHEV relative to a BEV to reflect a utility factor of 41 percent for vocational vehicles and 22 percent for tractors and we conservatively estimated that the depth of discharge of a PHEV battery would be only 60 percent compared to the BEV battery depth of discharge of 90 percent. The incremental component costs for

each of the HD TRUCKS 101 vehicle types are shown in RIA Chapter 2.11.2.4, including direct manufacturing costs and the battery tax credit as applicable.

The individual vehicles were aggregated into the corresponding regulatory class.<sup>794</sup> We then included the indirect manufacturing costs as well; the incremental additional retail price equivalent (RPE) for PHEVs by regulatory group using the 1.42 multiplier for MY 2030 are shown in Table II-46.

**Table II-46 Summary of MY 2030 Incremental RPE for Plug-in Hybrid Electric Vehicles (2022\$)**

Regulatory Group	RPE Costs
Light Heavy-Duty Vocational	\$21,774
Medium Heavy-Duty Vocational	\$28,552
Heavy Heavy-Duty Vocational	\$40,627
Day Cab Tractors	\$37,224
Sleeper Cab Tractors	\$53,514

the technologies is shown in Table II-47.

e. Summary of Technology Costs

A summary of the per vehicle incremental technology costs for each of

**Table II-47 Per Vehicle Cost of Technologies Relative to the MY 2027 Phase 2 Standards (2022\$)**

Vehicle Type	ICE Vehicles	Natural Gas	HEV	PHEV	H2 ICE
Light Heavy-Duty Vocational	\$0	(\$7,163)	\$7,976	\$21,774	\$3,872
Medium Heavy-Duty Vocational	\$0	(\$4,690)	\$11,979	\$28,552	\$19,785
Heavy Heavy-Duty Vocational	\$0	(\$3,232)	\$16,949	\$40,627	\$27,356
Day Cab Tractors	\$1,715	\$75	\$13,290	\$37,224	\$26,936
Sleeper Cab Tractors	\$1,978	\$1,888	\$16,080	\$53,514	\$44,919

iii. Technology Adoption Rates in the Additional Potential Compliance Pathways

As we did for the modeled potential compliance pathway, for this additional example potential compliance pathway we determined the technology mix of technologies for vehicles with ICE across a range of electrification, which for this additional pathway consists of a mix of adoption of natural gas vehicles, hybrid vehicles, plug-in hybrid

vehicles, H2-ICE vehicles, and aerodynamic and tire rolling resistant improvements for tractors for MYs 2027, 2030 and 2032, and including those ZEVs from our projected reference case ZEV adoption rates as described in RIA Chapter 4. These values represent the total national HD vehicle sales, including those accounted for in the reference case. However, for this additional example compliance pathway, the portion of the overall HD

sales that are projected to be ZEVs in the reference case are the same portion projected to be ZEVs under the final rule (*i.e.*, no additional ZEVs are included to meet the final Phase 3 standards). Thus, this additional example compliance pathway supports the feasibility of the Phase 3 standards relative to the “no action” projection of ZEV adoption nationwide. We considered two scenarios for the adoption rates in MY 2032. The

<sup>794</sup> The sleeper cab tractor costs were calculated using Vehicles 32, 78, and 79.

adoption rates for this pathway are shown in Table II–48 through Table II–50.

**Table II-48 Adoption Rates of Technologies to meet Final Standards for MY 2027 Relative to Reference Case**

Vehicle Type	Reference Case ZEVs	ICE Vehicles <sup>a</sup>	Natural Gas	HEV	PHEV	H2 ICE
Light Heavy-Duty Vocational	10%	33%	5%	52%	0%	0%
Medium Heavy-Duty Vocational	7%	48%	5%	40%	0%	0%
Heavy Heavy-Duty Vocational	N/A, standards begin in MY 2029					
Day Cab Tractors	N/A, standards begin in MY 2028					
Sleeper Cab Tractors	N/A, standards begin in MY 2030					

<sup>a</sup> The ICE vocational vehicles include the technology packages to meet the Phase 2 MY 2027 emission standards, as described in section II.D.1.

**Table II-49 Adoption Rates of Technologies to meet Final Standards for MY 2030 Relative to Reference Case**

Vehicle Type	Reference Case ZEVs	ICE Vehicles <sup>a</sup>	Natural Gas	HEV	PHEV	H2 ICE
Light Heavy-Duty Vocational	25%	27%	5%	43%	0%	0%
Medium Heavy-Duty Vocational	17%	48%	5%	30%	0%	0%
Heavy Heavy-Duty Vocational	11%	71%	5%	10%	3%	0%
Day Cab Tractors	9%	74%	5%	0%	12%	0%
Sleeper Cab Tractors	2%	91%	5%	2%	0%	0%

<sup>a</sup> The ICE vocational vehicles include the technology packages to meet the Phase 2 MY 2027 emission standards, as described in section II.D.1. The ICE tractors include the technology package described in section II.F.4.i.a.

**Table II-50 Adoption Rates of Technologies to meet Final Standards for MY 2032 and later Relative to Reference Case**

Vehicle Type	Reference Case ZEVs	ICE Vehicles <sup>a</sup>	Natural Gas	HEV	PHEV	H2 ICE
<i>Scenario 1 (H2-ICE focus)</i>						
Light Heavy-Duty Vocational	30%	1%	5%	40%	0%	24%
Medium Heavy-Duty Vocational	21%	18%	5%	44%	0%	13%
Heavy Heavy-Duty Vocational	14%	42%	5%	27%	0%	12%
Day Cab Tractors	10%	39%	5%	20%	0%	26%
Sleeper Cab Tractors	5%	64%	5%	10%	0%	17%
<i>Scenario 2 (PHEV focus)</i>						
Light Heavy-Duty Vocational	30%	5%	5%	0%	60%	0%
Medium Heavy-Duty Vocational	21%	19%	5%	24%	32%	0%
Heavy Heavy-Duty Vocational	14%	13%	5%	50%	18%	0%
Day Cab Tractors	10%	0%	5%	20%	55%	10%
Sleeper Cab Tractors	5%	5%	5%	30%	55%	0%

<sup>a</sup> The ICE vocational vehicles include the technology packages to meet the Phase 2 MY 2027 emission standards, as described in section II.D.1. The ICE tractors include the technology package described in section II.F.4.i.a.

iv. Additional Example Potential Compliance Pathways—Manufacturer Costs To Meet the Final Standards

The fleet average per-vehicle technology costs of the additional

example potential compliance pathway relative to the reference case (that includes ZEV adoption in the reference case, at the adoption rates of our “no action” reference case in RIA Chapter 4)

are shown in Table II–51 for MYs 2027, 2030 and 2032.

**Table II-51 Average Technology Package Cost Per Vehicle to Meet the MY 2027, MY 2030, and MY 2032 Final Standards (2022\$) Relative to Reference Case**

Regulatory Group	MY 2027	MY 2030	MY 2032	
			Scenario 1 (H2-ICE focus)	Scenario 2 (PHEV focus)
Light Heavy-Duty Vocational	\$3,789	\$ 3,072	\$ 3,762	\$ 12,706
Medium Heavy-Duty Vocational	\$4,557	\$ 3,359	\$ 7,608	\$ 11,777
Heavy Heavy-Duty Vocational	N/A	\$ 2,752	\$ 7,697	\$ 15,626
Day Cab Tractors	N/A	\$ 5,745	\$ 10,327	\$ 25,822
Sleeper Cab Tractors	N/A	\$ 2,218	\$ 10,376	\$ 34,456

**BILLING CODE 6560-50-C**

We developed two scenarios for MY 2032. Scenario 1 includes H2-ICE vehicles without any PHEVs. Scenario 2 predominately includes PHEVs with only limited adoption of H2-ICE technology in day cab tractor applications. We estimate in Scenario 1 that the MY 2032 fleet average per-vehicle cost to manufacturers by regulatory group will be \$3,800 for LHD; \$7,600 for MHD vocational vehicles; and \$7,700 for HHD vocational vehicles. The MY 2032 fleet average per-vehicle costs to manufacturers in Scenario 1 will range between \$10,300 for day cab tractors and \$10,400 per sleeper cab tractors. The Phase 2 MY 2027 tractor standard incremental fleet average per-vehicle costs were projected to be between \$12,750 and \$17,125 (2022\$) per vehicle and the vocational vehicle standards were projected to cost between up \$7,090 (2022\$) per vehicle.<sup>795</sup> EPA notes the projected costs per vehicle for this final rule under Scenario 1 are similar to the fleet average per-vehicle costs projected for the HD Phase 2 rule that we considered to be reasonable.<sup>796</sup> EPA’s assessment here is similarly that these estimated costs are reasonable for all model years.

The projected manufacturer fleet average per-vehicle technology costs in Scenario 2 for MY 2032 are higher than Scenario 1. We developed this scenario because manufacturers may choose to offer technologies, such as PHEVs, that have a higher projected upfront cost, but also have a shorter payback period and therefore potentially a better business case and purchasers may demonstrate more willingness to buy. The costs to tractor manufacturers in the PHEV-focused scenario represent approximately 18 percent of the price of a new tractor (conservatively estimated to be \$140,000 for day cab tractors and

\$190,000 for sleeper cab tractors in 2023).<sup>797</sup> We believe this is reasonable here for all model years given consideration of the corresponding business case for manufacturers to successfully deploy these technologies when considering the payback period of these technologies, including the IRA purchaser tax credits for PHEVs.

**v. Additional Example Potential Compliance Pathways—Purchaser Cost Considerations**

In this section, we discuss items associated with the purchaser costs for each of the technologies considered. Under this approach for vehicles with ICE technologies, our evaluation of payback focuses on whether the technology pays back within the period of first ownership. Consistent with our Phase 2 approach to vehicles with ICE technologies, if the vehicle with ICE technology pays back within this period, then we consider that technology within the additional example potential compliance pathways. We also evaluate payback period, consistent with our approach to consideration of payback in Phase 2 for vehicles with ICE technologies.<sup>798</sup> See also our discussion of first ownership in section II.F.1 of this preamble. We also evaluated and included vehicle with ICE technologies if we assessed there may be other reasons that purchasers would consider such technologies, such as that the vehicles emit nearly zero CO<sub>2</sub> emissions at the tailpipe, low engine-out exhaust emissions provide the opportunity for efficient and durable after-treatment systems, and the potential for future efficiency improvements within the lead time provided.

**a. ICE Vehicles**

Reducing the energy required to move a tractor down the road through aerodynamic improvements and reductions in tire rolling resistance will

lead to reduction in operating costs. Our technology packages that include additional improvements to ICE vehicles reduced the CO<sub>2</sub> emissions, and therefore energy consumption, by 4 percent. The cost savings related to the reduction in fuel and DEF consumed depends on the number of miles driven, among other factors. The average DEF and diesel fuel costs for each of the baseline diesel-fueled ICE vehicle applications in HD TRUCS were developed as discussed in RIA Chapter 2.3.4. As shown in RIA Chapter 2.11.5.1, the average operating cost savings varies depending on the vehicle ID, ranging from approximately \$280 to \$1,800 per year. The average annual operating savings for a day cab tractor is \$700 and is \$1,600 for a sleeper cab tractor. Based on the technology package costs shown in section II.F.4.ii.a for additional ICE vehicle improvements, the payback period for the technology improvements would be less than three years for day cab tractors and less than two years for sleeper cab tractors.

**b. Natural Gas Fueled Vehicles**

The operating savings of NG vehicles come from both the elimination of the DEF costs because these vehicles use three-way catalysts and from the reduced fueling costs. When comparing fuel efficiency between diesel and SI natural gas powered HD vehicles, dependent on vehicle and duty cycle, natural gas returns 7 percent to 12 percent less fuel economy.<sup>799</sup> Therefore, we calculated the natural gas consumption using a conversion factor of 139.3 standard cubic feet (scf) to diesel gallon equivalent and applying a 10 percent fuel economy penalty to the diesel fuel consumption.<sup>800</sup> The average diesel fuel consumption, diesel fuel costs, and DEF costs for each of the

<sup>795</sup> The Phase 2 tractor MY 2027 standard cost increments were projected to be between \$10,200 and \$13,700 per vehicle in 2013\$ (81 FR 73621). The Phase 2 vocational vehicle MY 2027 standards were projected to cost between \$1,486 and \$5,670 per vehicle in 2013\$ (81 FR 73718).

<sup>796</sup> 81 FR 73621-622 (tractors) and 73718-19 (vocational vehicles).

<sup>797</sup> Memo to Docket. “Sample Heavy-Duty Truck Prices in 2023.” Docket EPA-HQ-OAR-2022-0945.

<sup>798</sup> See 81 FR 73621-622 (tractors) and 73718-19 (vocational vehicles).

<sup>799</sup> Department of Energy, Energy Efficiency and Renewable Energy, Alternative Fuel Data Center, Vehicle and Infrastructure Cash-Flow Evaluation Tool (VICE), [https://afdc.energy.gov/vice\\_model/](https://afdc.energy.gov/vice_model/), accessed February 17, 2024.

<sup>800</sup> U.S. DOE. Available online: [https://afdc.energy.gov/fuels/equivalency\\_methodology.html](https://afdc.energy.gov/fuels/equivalency_methodology.html).

baseline diesel-fueled ICE vehicle applications in HD TRUCKS were developed as discussed in RIA Chapter 2.3.4. We then calculated the average annual natural gas fuel costs for each of the HD TRUCKS applications by vehicle ID using \$18.23/thousand cubic feet price, as shown in RIA Chapter 2.11.5.2.<sup>801</sup> The natural gas powered vehicles have immediate paybacks for some vehicle categories and payback periods of less than one year for all applications when the operating savings are compared to the upfront incremental costs of the NG vehicles, as shown in section II.F.4.ii.b.

c. H2-ICE Vehicles

The operating costs of H2-ICE vehicles include H2 consumption to power the engine and DEF consumption to control the NOx emissions. These costs are compared to the operating DEF and diesel fuel costs for each of the baseline diesel-fueled ICE vehicle applications in HD TRUCKS, as discussed in RIA Chapter 2.3.4.

H2-ICE vehicles operate on H2 gas instead of diesel fuel. We calculated the H2-ICE hydrogen fuel costs relative to our assessment of the hydrogen costs for FCEVs for each of the vehicle applications in HD TRUCKS, as discussed in RIA Chapter 2.5.3.1. When comparing efficiencies between FCEV and H2-ICE vehicles, the FCEVs have an average efficiency of 53 percent, as discussed in RIA Chapter 2.5.1.2.1, while H2-ICEV has an efficiency of 42 percent.<sup>802</sup> Therefore, we calculated the H2 fueling costs for H2-ICE relative to the FCEV fueling costs by applying a ratio of 0.53/0.42.

The H2-ICE vehicles also require a SCR system to control NOx, but the system will be smaller than a comparable diesel ICE vehicle because the engine-out NOx emissions are lower. We calculated the annual DEF costs for H2-ICE vehicles as 10 percent of the DEF costs for a comparable baseline

diesel ICE vehicle.<sup>803</sup> The average DEF costs for each of the baseline diesel-fueled ICE vehicle applications in HD TRUCKS were developed as discussed in RIA Chapter 2.3.4. The net annual operating savings for each of the HD TRUCKS vehicle applications by vehicle ID is shown in RIA Chapter 2.11.5.3. The upfront H2-ICE powertrain technology costs, as shown in section II.F.4.ii.c, on average would pay back in 2 years for LHD vocational vehicles, 6 years for MHD vocational vehicles, 9 years for HHD vocational vehicles. The operating costs for H2-ICE tractors exceed the operating costs of ICE tractors, but there may be other reasons that purchasers would consider this technology such as the vehicles emit nearly zero CO<sub>2</sub> emissions at the tailpipe, the low engine-out exhaust emissions from H2-ICE vehicles provide the opportunity for efficient and durable after-treatment systems, and the efficiency of H2-ICE vehicles may continue to improve with time.<sup>804</sup>

d. Hybrid and Plug-In Hybrid Vehicles

Hybrid vehicles, similar to other ICE vehicle improvements, will have lower operating costs than a comparable ICE vehicle due to reduced diesel fuel consumption and DEF consumption. These HEV costs are compared to the operating DEF and diesel fuel costs for each of the baseline diesel-fueled ICE vehicle applications in HD TRUCKS, as discussed in RIA Chapter 2.3.4. As discussed, we used an effectiveness level for vocational vehicle hybrid powertrains of 15 percent and for tractor hybrid powertrains of 10 percent.

The annual operating savings for HEVs was calculated for each of the HD TRUCKS vehicle applications, as shown in RIA Chapter 2.11.5.4 by reducing the diesel ICE DEF and fuel costs by 15 percent for vocational vehicles and 10 percent for tractors. The annual

operating savings were then compared to the upfront technology costs, as shown in section II.F.4.ii.d. The hybrid powertrain technology will pay back in 10-11 years for vocational vehicles, but in a shorter period of time for some applications such as refuse haulers, step vans, and transit buses. The average payback period for this technology in day cab tractors is 7.5 years and 4 years in sleeper cab tractors.

Similar to our discussion for ZEVs under the modeled potential compliance pathways, the IRA provides powerful incentives in reducing the cost to manufacture and purchase PHEVs, as well as reducing the cost of charging infrastructure as applicable (see further discussion in this section), that facilitates market penetration of PHEV technology in the time frame considered in this rulemaking. The upfront costs to purchasers of PHEVs would be less than the cost to manufacturers due to the IRA purchaser tax credit. IRA section 13403, "Qualified Commercial Clean Vehicles," creates a tax credit of up to \$40,000 per Class 4 through 8 HD vehicle (up to \$7,500 per Class 2b or 3 vehicle) for the purchase or lease of a qualified commercial clean vehicle. This tax credit is available from CY 2023 through CY 2032 and is based on the lesser of the incremental cost of the clean vehicle over a comparable ICE vehicle or the specified percentage of the basis of the clean vehicle, up to the maximum \$40,000 limitation. Among other specifications, these vehicles must be on-road vehicles (or mobile machinery) that are propelled to a significant extent by a battery-powered electric motor or are qualified fuel cell motor vehicles. For the former, the battery must have a capacity of at least 15 kWh (or 7 kWh if it has a gross vehicle weight rating of less than 14,000 pounds (Class 3 or below)) and must be rechargeable from an external source of electricity. For PHEVs, the per-vehicle tax credit cap limitation is 15 percent of the vehicle cost, which is the limiting factor for many of the applications. Since this tax credit overlaps with the model years for which we are finalizing standards (MYs 2027 through 2032), we included it in our calculations for each of those years in our analysis, as shown in Table II-52.

<sup>799</sup> Department of Energy, Energy Efficiency and Renewable Energy, Alternative Fuel Data Center, Vehicle and Infrastructure Cash-Flow Evaluation Tool (VICE), [https://afdc.energy.gov/vice\\_model/](https://afdc.energy.gov/vice_model/), accessed February 17, 2024.

<sup>800</sup> U.S. DOE. Available online: [https://afdc.energy.gov/fuels/equivalency\\_methodology.html](https://afdc.energy.gov/fuels/equivalency_methodology.html).

<sup>801</sup> U.S. DOE/Energy Information Administration. Annual Energy Outlook 2023. Reference Case. Table 13. Transportation Natural Gas Spot Price for 2022. Available online: <https://www.eia.gov/outlooks/aeo/data/browser/#/?id=13-AEO2023&cases=ref2023&sourcekey=0>.

<sup>802</sup> FEV, "Hydrogen ICE", The Aachen Colloquium Sustainable Mobility, October 5th-7th, 2020.

<sup>803</sup> Sma, Ales. Sandia National Laboratory. "The

**Table II-52 Upfront Incremental Technology Costs for Plug-in Hybrid Vehicle Purchasers – MY 2027 and Later**

Vehicle Type	PHEV Costs before Tax Credit	PHEV Costs After Tax Credit
Light Heavy-Duty Vocational	\$21,774	\$5,465
Medium Heavy-Duty Vocational	\$28,552	\$7,652
Heavy Heavy-Duty Vocational	\$40,627	\$8,962
Day Cab Tractors	\$37,224	\$11,024
Sleeper Cab Tractors	\$53,514	\$17,043

The purchaser of a HD PHEV would need to consider the recharging needs of the vehicle. Because the battery sizes in HD PHEVs are significantly smaller than a comparable BEV and only discharge 60 percent of their battery in-use, the recharging demand is also lower than a comparable BEV. Therefore, for this analysis, the vehicles use depot charging and recharge with a 240 V/50 amp outlet that we project are available at no additional upfront infrastructure cost. There may be situations where the operator would need to create access to such an outlet, but those costs would be low. Furthermore, as discussed in RIA Chapter 1.3.2, the IRA can also help reduce the costs for deploying EVSE infrastructure if the operator desires faster recharging times. The IRA extends the Alternative Fuel Refueling Property Tax Credit (section 13404) through 2032, with modifications. Under the new provisions, businesses would be eligible for up to 30 percent of the costs associated with purchasing and installing charging equipment in these areas (subject to a \$100,000 cap per item) if prevailing wage and apprenticeship requirements are met.

Plug-in hybrid vehicle operating costs consist of a combination of ICE operation and battery electric operation. These PHEV costs are calculated relative to the operating costs for each of the baseline diesel-fueled ICE vehicle applications in HD TRUCKS, as discussed in RIA Chapter 2.3.4 and the comparable BEV operating costs, as discussed in RIA Chapter 2.4.4. As discussed, we used a utility factor for vocational vehicle PHEV powertrains of 41 percent and for tractor PHEV powertrains of 22 percent in MY 2030 and later. The annual operating savings was evaluated for each of the HD TRUCKS vehicle applications compared to the comparable baseline diesel ICE vehicle, as shown in RIA Chapter 2.11.5.4. The incremental cost of the

PHEV powertrain technology after accounting for the IRA tax credit as shown in Table II–52 for vocational vehicles will be offset by the operating savings with a payback period of 3 years. The day cab and sleeper cab tractor upfront costs would be offset with operational savings over an 8-and 9-year period, respectively.

*G. EPA’s Basis for Concluding That the Final Standards Are Feasible and Appropriate Under the Clean Air Act*

1. Overview

Section 202(a)(1) directs the Administrator to promulgate “standards applicable to the emission of any air pollutant from any class or classes of new motor vehicles or new motor vehicle engines, which in his judgment cause, or contribute to, air pollution which may reasonably be anticipated to endanger public health or welfare.” See also *Coalition for Responsible Regulation v. EPA*, 684 F. 3d at 122 (“the job Congress gave [EPA] in § 202(a)” is “utilizing emission standards to prevent reasonably anticipated endangerment from maturing into concrete harm”). As discussed in section II.A of this preamble, there is a critical need for further GHG reductions to address the adverse impacts of air pollution from HD motor vehicles on public health and welfare. Heavy-duty vehicles are significant contributors to the U.S. GHG emissions inventories, and additional reductions in GHGs from vehicles are needed to avoid the worst consequences of climate change as discussed in section II.A. With continued advances in internal combustion engine and vehicle emissions controls and ZEV technologies coming into the mainstream as key vehicle emissions controls, EPA’s assessment is that substantial further GHG emissions reductions are feasible and appropriate under Clean Air Act section 202(a)(1).

To this end, as in the HD GHG Phase 1 and Phase 2 rulemakings, in this Phase 3 final rule we considered the following factors in setting final Phase 3 GHG standards: the impacts of potential standards on reductions of GHG emissions; technical feasibility and technology effectiveness; the lead time necessary to implement the technologies; costs to manufacturers; costs to purchasers including operating savings; reduction of non-GHG emissions; the impacts of standards on oil conservation and energy security; the impacts of standards on the truck industry; other energy impacts; as well as other relevant factors such as impacts on safety.<sup>805</sup> To evaluate and balance these statutory factors and other relevant considerations, EPA must necessarily estimate a means of compliance: what technologies are projected to be available to be used, what do they cost, and what is appropriate lead time for their deployment. Thus, to support the feasibility of the final standards, EPA identified a potential compliance pathway. Having identified one means of compliance, EPA’s task is to “answe[r] any theoretical objections” to that means of compliance, “identif[y] the major steps necessary,” and to “offe[r] plausible reasons for believing that each of those steps can be completed in the time available.” *NRDC*

<sup>804</sup> As we explain in RTC 2.1, the statute does not require that pollution control technologies pay back in the form of operational savings, or even require EPA to consider costs to consumers. While payback is relevant to ascertaining willingness to purchase, EPA notes that many pollution control technologies do not pay back. Notwithstanding the lack of payback, such technologies have played a critical role in achieving the public health and welfare goals of section 202(a) and have been widely adopted by manufacturers and purchasers. These include technologies Congress itself contemplated in enacting the Clean Air Act section 202(a), such as catalytic converters, as well as other technologies that are the foundation for modern pollution control on HD motor vehicles, such as particulate matter filters.

v. *EPA*, 655 F. 2d at 332. That is what EPA has done here in this final rule, and indeed what it has done in all of the motor vehicle emission standard rules implementing section 202(a) of the Act for half a century.

In assessing the means of compliance, EPA considers updated data available at the time of this rulemaking, including real-world technological and corresponding cost developments related to emissions-reducing technologies for HD vehicles. The statute directs EPA to assess the “development and application of the requisite technology, giving appropriate consideration to the cost of compliance within” the relevant timeframe, and specifically compels EPA to consider relevant emissions-reduction technologies on vehicles and engines regardless of “whether such vehicles and engines are designed as complete systems or incorporate devices to prevent or control such pollution.” CAA section 202(a)(1), (2). The statute does not prescribe particular technologies, but rather entrusts to the EPA Administrator the authority and obligation to identify a range of available technologies that have the potential to significantly control or prevent emissions of the relevant pollutant, here GHGs, and to establish standards based on his consideration of the lead-time and costs for such technologies, along with other factors. At the same time, the statute does specifically identify criteria for technologies that cannot serve as the basis for the standards: first, technologies which cannot be developed and applied within the relevant time period, giving appropriate consideration to the cost of compliance; and second, technologies that “cause or contribute to an unreasonable risk to public health, welfare, or safety in its operation or function.” CAA section 202(a)(2), (4). The statute does not contain or imply any other exclusions. Given the statute’s primary purpose and function to reduce emissions of air pollutants which are contributing to endangering air pollution, the statute therefore compels EPA to consider technologies that reduce emissions of air pollutants most effectively, including vehicle technologies that result in no vehicle tailpipe emissions and completely “prevent” GHG emissions. CAA section 202(a)(1). At minimum, the statute allows EPA to consider such technologies. Pursuant to the statutory mandate and as explained throughout this preamble, EPA has considered the full range of vehicle technologies that meet these criteria and

that we anticipate will be available in the MY 2027–32 timeframe, including numerous advanced vehicles with ICE (e.g., hybrid), BEV, and FCEV technologies which include a range of electrification (including within ICE engine and vehicle technologies).

Another part of EPA’s consideration of updated data is to evaluate changes in government and regulatory incentives, which can have real and significant impacts on the development and application of vehicle technologies. Accordingly, an important element of this rule’s assessment is consideration of the large potential impact that recent congressional action, including the BIL and the IRA, will have on the cost and feasibility of HD motor vehicle CO<sub>2</sub> emission-reducing technologies, including facilitating production and adoption of ZEV technologies for HD motor vehicles. EPA’s consideration of all these factors demonstrates that very large GHG emissions reductions are feasible for HD vehicles in the MY 2027–32 timeframe and that such reductions can be achieved using a combination of advanced ICE vehicle, BEV, and FCEV technologies at reasonable cost. As noted, manufacturers remain free to choose how to comply with the final standards (and, indeed, manufacturers have at times chosen different means from those projected as a potential compliance pathway in previous rulemakings to comply with the respective standards). EPA’s analysis in preamble section II.F.4 further supports the feasibility of the final standards by showing that such GHG emission reductions can be achieved using different mixes of vehicles with ICE technologies, including without producing additional ZEVs to comply with this rule as described in the additional example potential compliance pathway.

The balance of this section summarizes the key factors found in the administrative record (including the entire preamble, RIA, and RTC) that form the basis for the Administrator’s determination that the final standards are feasible and appropriate under our Clean Air Act section 202(a)(1)–(2) authority. Section II.G.2 discusses the statutory factors of technological feasibility, compliance costs, and lead time, and it explains that the final standards are predicated upon technologies that are feasible and of reasonable cost during the timeframe for this rule. Section II.G.3 evaluates emissions of GHGs, and it finds that the final standards would achieve significant GHG reductions that make an important contribution to climate change mitigation. Section II.G.4

evaluates other relevant factors that are important to evaluating the real-world feasibility of the standards as well as their impact, including impacts on purchasers, non-GHG emissions, energy, safety, and other factors. It concludes that the final standards will result in considerable benefits for purchasers and operators of HD vehicles, result in public health and welfare benefits from non-GHGs, create positive energy security benefits for the United States, and not create an unreasonable risk to safety. Section II.G.5 explains how the Administrator exercised the authority Congress provided to the agency in balancing the various factors we considered. It articulates the key factors that were dispositive to the Administrator’s decision in selecting the final standards, including feasibility, compliance costs, lead time, GHG emissions reductions, and cost to purchasers; as well as other factors, such as non-GHG emissions, energy, and safety, that were not used to select the standards but that nonetheless provide further support for the Administrator’s decision. On balance, this section II.G, together with the rest of the administrative record, demonstrates that the final standards are supported by voluminous evidence, the product of the agency’s well-considered technical judgment and the Administrator’s careful weighing of the relevant factors, and that these standards faithfully implement the important directive contained in section 202(a)(1)–(2) of the Clean Air Act to reduce emissions of air pollutants from motor vehicles which cause or contribute to air pollution that may reasonably be anticipated to endanger public health or welfare.

## 2. Consideration of Technological Feasibility, Compliance Costs and Lead Time

The technological readiness of the heavy-duty industry to meet the final standards for model years 2027–2032 and beyond is best understood in the context of over a decade of heavy-duty vehicle emissions reduction programs in which the HD industry has introduced emissions reducing technologies in a wide lineup of ever more efficient and cost-competitive vehicle applications. Electrification technologies beyond the range included in vehicles with ICE have seen particularly rapid development and an expansion in the range of electrification over the last several years, such that early HD ZEV models are in use today for some applications and are expected to expand to many more applications, as discussed in RIA Chapters 1.5 and 2. The IRA



provides powerful incentives in reducing the cost to manufacture and purchase ZEVs, as well as promoting the build-out and reducing the cost of charging infrastructure, that EPA projects will facilitate increased market penetration of ZEV technology in the time frame considered in this rulemaking. As a result, the number of ZEVs projected in the potential compliance pathway's technology packages we modeled to support the feasibility of the final standards is higher than in the technology packages on which the Phase 1 and 2 HD GHG standards are predicated.

As discussed in RIA Chapter 1.5.5 and section II.D, the modeled example potential compliance pathway to support the feasibility of the final standards includes only technologies that have already been developed and deployed. Additionally, manufacturers have announced plans to rapidly increase their investments in ZEV technologies over the next decade, and have already expended billions of dollars to do so. In addition, as noted, the IRA and the BIL provide many monetary incentives for the production and purchase of ZEVs in the heavy-duty market, as well as incentives for electric vehicle charging infrastructure. Furthermore, there have been multiple actions by states to accelerate the adoption of heavy-duty ZEV technologies, such as (1) a multi-state Memorandum of Understanding for the support of heavy-duty ZEV adoption<sup>806</sup> and (2) the State of California's ACT program, which has also been adopted by other states under CAA section 177 and includes a manufacturer requirement for zero-emission truck sales.<sup>807</sup> Together with the range of ICE technologies that have been already demonstrated over the past decade, BEVs and FCEVs with no tailpipe emissions (and 0 g CO<sub>2</sub>/ton-mile certification values) are capable of supporting rates of annual stringency increases that are much greater than were available in earlier GHG rulemakings. Hence, EPA supports the feasibility of the final standards through a modeled potential compliance pathway reflecting the utilization of a mix of HD vehicle technologies, including the technologies most

successful at reducing GHG emissions. The modeled potential compliance pathway is not a command, but one demonstration of a means of meeting the standards, not foreclosing other means. EPA's analysis of additional vehicles with ICE technology packages and the technical feasibility, technical effectiveness, lead time, and cost of compliance of corresponding additional example potential compliance pathways in preamble section II.F.4 further supports the feasibility of the final standards by showing that such GHG emission reductions can be achieved using different mixes of vehicles with ICE technologies, including without producing additional ZEVs to comply with this rule.

In setting GHG standards for a future model year, EPA considers the extent deployment of advanced existing and future technologies, including the technologies most effective at reducing GHG emissions, would be available and warranted in light of the benefits to public health and welfare in GHG emission reductions, and potential constraints, such as cost of compliance, lead time, raw material availability and component supplies (including availability of minerals critical to battery manufacture and resiliency of associated supply chains), redesign cycles, charging and refueling infrastructure availability and cost, and purchasers' willingness to purchase (including payback). In the modeled potential compliance pathway supporting the feasibility of the final standards, EPA assessed these considerations. The extent of these potential constraints for the potential compliance pathway has diminished significantly in light of increased and further projected investment by manufacturers, increased and further projected acceptance by purchasers, and significant support from Congress to address such areas as upfront purchase price, charging infrastructure, critical mineral supplies, and domestic supply chain manufacturing. In response to the increased stringency of the final standards, in the potential compliance pathway we project that manufacturers will adopt advanced technologies, such as increased electrification, at an increasing pace across more of their vehicles. To evaluate the feasibility of BEVs and FCEVs in our modeled potential compliance pathway's technology packages that support the feasibility of the final standards, EPA developed, and for the final rule refined, a tool called HD TRUCS, to evaluate the design features needed to meet the energy and power demands of various

HD vehicle types when using BEV, FCEV, and PHEV technologies. The overarching design and functionality of HD TRUCS is premised on assessing whether, for each of the 101 vehicle types analyzed, BEV, FCEV, and PHEV technologies could perform the same work as a comparable ICE vehicle counterpart. Within the HD TRUCS modeling that EPA conducted to support this final rule, we have imposed constraints to reflect the rate at which a manufacturer can deploy BEV technologies that include consideration of time necessary to ramp up battery production, including the need to increase the availability of critical raw minerals and develop more robust supply chains, and expand battery production facilities, as discussed in section II.D.2.c.ii. Furthermore, we have also imposed constraints to reflect the development and deployment of FCEVs, as discussed in section II.D.3.

Constraints on the technology adoption limits in HD TRUCS and correspondingly our modeled potential compliance pathway, as well as other aspects of our lead time assessment, are described in section II.F. Overall, given the measured approach we have taken to phase in the rate of deployment for new HD vehicles, our assessment shows that there is sufficient lead time for the industry to more broadly deploy existing technologies and successfully comply with the final standards should they pursue this or similar compliance pathways. Should manufacturers pursue other compliance pathways like the examples outlined in section II.F.4, there also is sufficient lead time given that the technologies have already been developed, most of the technologies have already been deployed and some are already in widespread use, and there are generally fewer concerns regarding availability of supporting infrastructure and critical minerals availability.

Our modeled potential compliance pathway's technology packages to support feasibility of the final standards project that, for the industry overall, nearly 50 percent of new vocational vehicle sales and 25 to 40 percent of new tractor sales in MY 2032 will be ZEVs. As noted in section II.F.1, this represents approximately 1 percent of the HD on-road fleet in 2027 growing to 7 percent of the on-road fleet in 2032. EPA believes that this is an achievable level based on our technical assessment for this final rule that includes consideration of the feasibility and lead time required for ZEVs and appropriate consideration of the cost of compliance for manufacturers. Our assessment of the appropriateness of the level of ZEVs in our analysis is also informed by

<sup>806</sup> NESCAUM MOU, available at <https://www.nescaum.org/documents/mhdv-zev-mou-20220329.pdf>.

<sup>807</sup> EPA granted the ACT rule waiver requested by California under CAA section 209(b) on March 30, 2023. The ACT had been adopted by seven states under CAA section 177: Oregon, Washington, New York, New Jersey, and Massachusetts adopted ACT beginning in MY 2025 while Vermont adopted ACT beginning in MY 2026 and Colorado in MY2027.

consideration of comments as well as by substantial investments by manufacturers, as described in RIA Chapter 1. More detail about our technical assessment, and our assessment of the production feasibility of ZEVs is provided in section II.D and II.E of this preamble and Chapters 1 and 2 of the RIA.

At the same time, we again note that the final standards are performance-based and do not mandate any specific technology for any manufacturer or any vehicles. The modeled potential compliance pathway is one of many possible compliance pathways that manufacturers could choose to take to meet the performance-based standards. That is, we do not expect, and the standards do not require, that all manufacturers follow a similar pathway. Instead, individual manufacturers can choose to apply a mix of technologies that best suits the company's particular product mix and market position as well as its strategies for investment and technology development. For example, manufacturers that choose to increase their sales of hybrid vehicle technologies or apply more or increase sales of advanced technologies for non-hybrid ICE vehicles would require a smaller number of ZEVs (including no ZEVs relative to the reference case) than we have projected in our assessment to support the feasibility of the final standards, as described in section II.F. In addition, while EPA has identified numerous technologies, available today, for meeting the standards, manufacturers and their suppliers are highly innovative and may develop novel technologies for achieving the requisite emissions reductions. For example, when EPA implemented certain statutory standards following the 1970 Clean Air Act Amendments, manufacturers met those standards through three-way catalysts, a theretofore unproven technology. More recently, manufacturers responded to EPA's 2001 heavy-duty rule by applying selective catalytic reduction technologies, even though EPA had not anticipated such technology would be utilized for compliance.<sup>808</sup>

In considering the feasibility of the final standards, EPA also considers the available compliance flexibilities on manufacturers' compliance options and the approach EPA takes in setting HD GHG vehicle standards that consider the averaging provisions within the program's established ABT provisions. The final performance-based standards with ABT provisions give manufacturers a degree of flexibility in the design of

specific vehicles and their fleet offerings, while allowing industry overall to meet the standards and thus achieve the health and environmental benefits projected for this rulemaking at a lower cost. EPA has considered ABT in the feasibility assessments for many previous rulemakings since EPA first began incorporating ABT credits provisions in mobile source rulemakings in the 1980s. In particular, consistent with our approach in Phase 2, EPA considered averaging in the standard setting process of the Phase 3 GHG standards, and our assessment is premised upon the availability of averaging in supporting the feasibility of the final standards. While we also considered the existence of other aspects of the ABT program as supportive of the feasibility of the Phase 3 GHG standards, we did not rely on those other aspects in justifying the feasibility of the standards. In other words, the existing ABT program will continue to help provide additional flexibility in compliance for manufacturers to make necessary technological improvements and reduce the overall cost of the program, without compromising overall environmental objectives; however, the other aspects of the ABT program that are not the availability of averaging, including credit carryover, deficits, banking, and trading, were not considered in setting the numeric levels of the Phase 3 standards. Likewise, the final transitional ABT provisions in this rule for credits from multipliers and credit transfers across averaging sets, described in preamble section III.A, that allow flexibility in compliance options for manufacturers were not considered in setting the numeric levels of the Phase 3 standards and we did not rely on those flexibilities in justifying the feasibility of the standards.

Manufacturers widely utilize ABT, which provide a variety of flexible paths to plan compliance. We have discussed this dynamic in past rules, and we anticipate that this same dynamic will support compliance with this rulemaking in the lead time afforded. The GHG credit program was designed to recognize that manufacturers typically have a multi-year redesign cycle and not every vehicle will be redesigned every year to add emissions-reducing technology. Moreover, when technology is added, it will generally not achieve emissions reductions corresponding exactly to a single year-over-year change in stringency of the standards. Instead, in any given model year, some vehicles will be "credit generators," over-performing compared

to their respective CO<sub>2</sub> emission standards in that model year, while other vehicles will be "debit generators" and under-performing against their standards. As the final standards reach increasingly lower numerical levels, some vehicle designs that had generated credits against their CO<sub>2</sub> emission standard in earlier model years may instead generate debits in later model years. In MY 2032 when the final standards reach the lowest level, it is possible that only BEVs, FCEVs, PHEVs, and H<sub>2</sub>-ICE vehicles are generating positive credits, and other ICE vehicles generate varying levels of deficits. A greater application of ICE vehicle technologies (e.g., hybrids) can enable compliance with fewer ZEVs than if less ICE technology was adopted, including a compliance strategy that does not include ZEVs, and therefore enable the tailoring of a compliance strategy to the manufacturer's specific market and product offerings. Together, a manufacturer's mix of credit-generating and debit-generating vehicles contribute to its sales-weighted average performance, compared to its standard, for that year.

Just as the averaging approach in the HD vehicle GHG program allows manufacturers to design a compliance strategy relying on the sale of both credit-generating vehicles and debit-generating vehicles in a single year, the credit banking and trading provisions of the program allow manufacturers to design a compliance strategy relying on overcompliance and undercompliance in different years, or even by different manufacturers. Credit banking allows credits to carry-over for up to five years and allows manufacturers up to three years to address any credit deficits. Credit trading is a compliance flexibility provision that allows one vehicle manufacturer to purchase credits from another.

The final performance-based standards with ABT provisions give manufacturers a degree of flexibility in the design of specific vehicles and their fleet offerings, while allowing industry overall to meet the standards and thus achieve the health and environmental benefits projected for this rulemaking. EPA has considered the averaging portion of the ABT program in the feasibility assessments for previous rulemakings and continues that practice here.

We also note the other provisions in ABT that provide manufacturers additional flexibility in complying with the standards.<sup>809</sup> By averaging across

<sup>809</sup> As noted, these additional flexibilities (other than averaging under the existing ABT program) are

<sup>808</sup> 66 FR 5002, 5036 (January 18, 2001).

vehicles in the vehicle averaging sets and by allowing for credit banking across years, manufacturers have the flexibility to adopt emissions-reducing technologies in the manner that best suits their particular market and business circumstances. We note further that we have added additional flexibilities to the ABT program as part of the Phase 3 final rule, which are aimed at providing flexibilities in the transitional MYs of the final Phase 3 standards as detailed in section III. EPA's annual Heavy-Duty Vehicle and Engine Greenhouse Gas Emissions Compliance Report illustrates how different manufacturers have chosen to make use of the GHG program's various credit features.<sup>810</sup> It is clear that manufacturers are widely utilizing several of the credit programs available, and we expect that manufacturers will continue to take advantage of the compliance flexibilities and crediting programs to their fullest extent, thereby providing them with additional tools in finding the lowest cost compliance solutions.

In addition to technological feasibility and lead time, EPA has considered the cost for heavy-duty manufacturers to comply with the final standards. See section II.F.2 of this preamble and Chapter 2 of the RIA for our analysis of compliance costs for manufacturers. For some regulatory groups, we estimate that the rule will result in incremental cost savings for some vehicle types and fleet average per-vehicle costs for others. We estimate that the MY 2032 fleet average per-vehicle cost savings to manufacturers are \$2,900 for LHD vocational vehicles, \$1,000 for MHD vocational vehicles and \$700 for HHD vocational vehicles. The MY 2032 fleet average per-vehicle costs to tractor manufacturers will range between \$3,200 for day cab tractors and \$10,800 per sleeper cab tractor. EPA notes the projected costs per vehicle for this final rule are lower than the fleet average per-vehicle costs projected for the HD GHG Phase 2 rule that we considered to be reasonable. 81 FR 73621 (tractors) and 73718 (vocational vehicles). The Phase

not necessary to EPA's determination that the final standards are feasible and appropriate. These additional flexibilities, however, do provide further support for the reasonableness of the final standards as they allow manufacturers to comply with the final standards using a greater variety of compliance pathways, including beyond those examples modeled or identified by EPA, and at lower costs, including below the costs set forth in the administrative record.

<sup>810</sup> U.S. EPA. "EPA Heavy-Duty Vehicle and Engine Greenhouse Gas Emissions Compliance Report." Available online: <https://www.epa.gov/compliance-and-fuel-economy-data/epa-heavy-duty-vehicle-and-engine-greenhouse-gas-emissions>.

2 MY 2027 tractor standard cost increments were projected to be between \$12,750 and \$17,125 (2022\$) per vehicle and the vocational vehicle standards were projected to cost between \$1,860 and \$7,090 (2022\$) per vehicle.<sup>811</sup> Furthermore, the estimated MY 2032 costs to tractor manufacturers represent less than about six percent of the average price of a new heavy-duty tractor today (conservatively estimated to be \$140,000 for day cab tractors and \$190,000 for sleeper cab tractors in 2023).<sup>812</sup> This is likewise within the margin that EPA considered reasonable in Phase 2.<sup>813</sup>

### 3. Consideration of Emissions of GHGs

An essential factor that EPA considered in determining the appropriate level of the final standards is the projected reductions in GHG emissions and associated public health and welfare impacts.<sup>814</sup>

The final GHG standards are projected to achieve significant reductions in GHG emissions. The final standards will achieve nearly 1 billion metric tons in net CO<sub>2</sub> cumulative emission reductions from calendar years 2027 through 2055 (see section V of this preamble and Chapter 4 of the RIA). As discussed in section VI of this preamble, these GHG emission reductions will make an important contribution to efforts to limit climate change and its anticipated impacts. See *Coal. For Resp. Reg.*, 684 F. 3d at 128 (removal of 960 million metric tons of CO<sub>2e</sub> over the life of the GHG vehicle emission standards rule was found by EPA to be "meaningful mitigation" of GHG emissions).

The final CO<sub>2</sub> emission standards will reduce adverse impacts associated with climate change discussed in section II.A and will yield significant benefits, including those we can monetize and

<sup>811</sup> The Phase 2 tractor MY 2027 standard cost increments were projected to be between \$10,200 and \$13,700 per vehicle in 2013\$ (81 FR 73621). The Phase 2 vocational vehicle MY 2027 standards were projected to cost between \$1,486 and \$5,670 per vehicle in 2013\$ (81 FR 73718).

<sup>812</sup> Memo to Docket. "Sample Heavy-Duty Truck Prices in 2023." Docket EPA-HQ-OAR-2022-0945.

<sup>813</sup> 81 FR 73621 and 73719.

<sup>814</sup> As further explained in section II.G.4, we note that our modeled potential compliance pathway supporting the feasibility of the final standards projects increased use of ZEV technologies in the HD vehicle fleet, which would reduce not just GHG emissions but also result in reductions of vehicle emissions of non-GHG pollutants that contribute to ambient concentrations of ozone, particulate matter (PM<sub>2.5</sub>), NO<sub>2</sub>, CO, and air toxics. EPA did not select the final GHG emission standards based on non-GHG reductions of vehicle emissions; nonetheless, the projected GHG and non-GHG reductions of vehicle emissions of the final program reinforce our view that the final standards represent an appropriate weighing of the statutory factors and other relevant considerations.

those we are unable to fully monetize due to data and modeling limitations. The GHG emission reductions resulting from compliance with this final rule will significantly reduce the volume of GHG emissions from this sector. Section VI.D.2 of this preamble discusses impacts of GHG emissions on individuals living in socially and economically vulnerable communities. The program will result in significant social benefits including \$10 billion in climate benefits (with the average SC-GHG under a 2 percent near-term Ramsey discount rate). These estimates are a partial accounting of climate change impacts and will therefore tend to be underestimates of the marginal benefits of abatement. A more detailed description and breakdown of these benefits can be found in section VII of the preamble and Chapter 7 of the RIA. As discussed in section VII, we monetize benefits of the final CO<sub>2</sub> standards and evaluate other costs in part to better enable a comparison of costs and benefits pursuant to E.O. 12866, but we recognize that there are benefits we are unable to fully quantify. EPA's consistent practice has been to set standards to achieve improved air quality consistent with CAA section 202 and not to rely on cost-benefit calculations, with their uncertainties and limitations, in identifying the appropriate standards. Nonetheless, our estimated benefits, which exceed the estimated costs of the final program, reinforce our view that the final standards represent an appropriate weighing of the statutory factors and other relevant considerations. More specifically, for this rule our assessment that the rule has positive net monetized benefits, regardless of the magnitude of those positive net benefits, supports our view that the final standards represent an appropriate weighing of the statutory factors and other relevant considerations. Thus, regardless of the method used in quantifying the monetized benefits of GHG reductions for purposes of this rulemaking, EPA would still find the emissions reductions, in light of the cost of compliance, available lead time and other relevant factors EPA considered, would justify adoption of these standards.

### 4. Consideration of Impacts on Purchasers, Non-GHG Emissions, Energy, Safety, and Other Factors

As noted in section II.G.2, the IRA provides powerful incentives in reducing the cost to manufacture and purchase ZEVs, as well as reducing the cost of charging infrastructure, that we project will facilitate increased market

penetration of ZEV technology in the time frame considered in this rulemaking. Businesses that operate HD vehicles are under competitive pressure to reduce operating costs, which should encourage purchasers to identify and rapidly adopt vehicle technologies that provide a reasonable payback period. Outlays for labor and fuel generally constitute the two largest shares of HD vehicle operating costs, depending on the price of fuel, distance traveled, type of HD vehicle, and commodity transported (if any), so businesses that operate HDVs face strong incentives to reduce these costs.<sup>815</sup> <sup>816</sup> However, as noted in RIA Chapter 6.2, there are a number of other considerations that may impact a purchaser's willingness to adopt new technologies. Regarding payback, within HD TRUCS we considered the impact on purchasers through our evaluation of payback periods. The payback period is the number of years that it will take for the annual operational savings of a ZEV to offset the incremental upfront purchase price of a BEV or FCEV (after accounting for the IRA section 13502 battery tax credit and IRA section 13403 vehicle tax credit) and upfront charging infrastructure costs for depot-charged BEVs (including IRA section 13404, "Alternative Fuel Refueling Property Credit") when compared to purchasing a comparable ICE vehicle. The modeled compliance pathway's average per-vehicle costs to a purchaser by regulatory group for a MY 2032 heavy-duty vehicle, including associated EVSE and after considering the IRA battery-manufacturer and vehicle-purchaser tax credits, are projected to range between \$1,500 and \$34,000 for vocational vehicles and \$4,300 and \$22,000 for tractors. As explained in section II.F.2.ii, EPA concludes that the final standards will be beneficial for purchasers because the lower operating costs during the operational life of the vehicle will offset the increase in vehicle technology costs within the usual period of first ownership of the vehicle, which can be 7 years or longer. For example, purchasers of MY 2032 vocational vehicles on average by regulatory group will recoup the upfront costs through operating savings within the first two to four years of ownership. Purchasers of MY 2032 tractors on average will recoup the upfront costs through operating savings within the

first two years for day cabs and first five years for sleeper cabs. Furthermore, the purchasers will benefit from annual operating cost savings for each year after the payback occurs. EPA finds that these projected average costs to purchasers are reasonable considering the operating savings which more than offsets these costs, as was also the case with the HD GHG Phase 2 rule. See 81 FR 73482, 73621 (tractors), 73719 (vocational vehicles). Regarding practicability, as discussed in detail in this section II, within HD TRUCS we also considered the impact on purchasers through our evaluation of the practicability and suitability. For example, we applied an additional constraint within HD TRUCS that limited the maximum ZEV adoption rate to 70 percent for any given vehicle type in MY 2032, 37 percent in MY 2030, and 20 percent in MY 2027. This conservative limit was developed after consideration of the needs of the purchasers, as discussed in section II.F.1.

For the final rule, we also conducted a complementary assessment of total cost of ownership (TCO) of BEVs and FCEVs from a purchaser's perspective, as discussed in RIA Chapter 2.12. In addition to the cost elements considered in our payback analysis, our TCO analysis also includes the costs of financing the vehicles and the impact of residual value. As the results show in RIA Chapter 2.12, we find that the costs for owning and operating a ZEV will be lower than a comparable ICE vehicle for all MY 2032 BEVs and FCEVs in our technology packages to support the modeled compliance pathway when evaluated over a five-year time horizon. In fact, all vehicles show several thousands of dollars in net TCO savings at the five-year point. We find that this TCO analysis further supports our assessment.

Within our analysis, to support the final standards we also considered the lead time necessary for the development of infrastructure associated with operating the vehicles, including consideration of the projected lead time necessary under the potential compliance pathway to install depot charging and supporting electrification infrastructure and to develop hydrogen infrastructure that will be required for the projected use of these technologies. As further explained in RIA Chapter 1.6 and sections II.E.2 and II.F.3, and RTC section 6, our assessment indicates that depot charging can be installed in time for the purchase and use of the volume of MY 2027 and later BEVs we project could be used to comply with the final standards, and we considered such purchaser costs in our analysis as

previously explained. We likewise find that there is adequate lead time for the infrastructure to support depot and public charging for the use of BEVs we project could be used to comply with the final standards, and included such costs in our manufacturer or purchaser cost analyses as appropriate. Section II.D.2.iii. With respect to hydrogen infrastructure, as further explained in RIA Chapter 1.8 and section II.F.3, we recognize that this may take longer to develop, and therefore we included a constraint for FCEVs such that we did not incorporate FCEVs into technology packages to support new standards for long-haul vehicles until MY 2030, when we expect refueling needs can be met for the volume of FCEVs we project could be used to comply with the final standards. We discuss issues relating to availability of critical minerals, resiliency of associated supply chains, and critical mineral security in section II.D.2.ii and in RTC section 17.2. As there discussed, we do not consider these to be insurmountable, including for the projections to comply with the final Phase 3 standards, and we thus do not consider them to be a constraining consideration.

We also assessed the impact of future HD BEVs on the grid, as discussed in section II.D.2.iii. Our analysis for the final rule shows that systems and processes exist to handle the impact on the power generation and transmission of this final rule, including when considered in combination with projections of other impacts on power generation and transmission based on our assessments at the time of this final rule. See RTC section 7.1; see also RIA Chapter 1.6. Therefore, we found that grid reliability is not expected to be adversely affected by the modest increase in electricity demand associated with HD BEV charging and thus was not considered to be a constraining consideration.

EPA considers our analysis of the impact of the final CO<sub>2</sub> emission standards on vehicle and upstream emissions for non-GHG pollutants as supportive of the final standards. The final standards will decrease vehicle emissions of non-GHG pollutants, and we expect those decreased emissions will contribute to reductions in ambient concentrations of ozone, particulate matter (PM<sub>2.5</sub>), NO<sub>2</sub>, CO, and air toxics. Similarly, we also project reductions in emissions of non-GHG pollutants from refineries (*i.e.*, NO<sub>x</sub>, PM<sub>2.5</sub>, VOC, and SO<sub>2</sub>). We project that non-GHG emissions from EGUs will increase as a result of the increased demand for electricity associated with the rule, but the magnitude of emissions increases

<sup>815</sup> American Transportation Research Institute, *An Analysis of the Operational Costs of Trucking*, September 2013. Docket ID: EPA-HQ-OAR-2014-0827-0512.

<sup>816</sup> Transport Canada, *Operating Cost of Trucks*, 2005. Docket ID: EPA-HQ-OAR-2014-0827-0070.

diminishes over time due to EGU regulations and changes in the future power generation mix, including impacts of the IRA. By 2055 there are net decreases in emissions from all pollutants except PM<sub>2.5</sub>; when the net changes in emissions of PM<sub>2.5</sub> and PM<sub>2.5</sub> precursors (e.g., VOC, NO<sub>x</sub>, SO<sub>2</sub>) are considered together, there are positive PM<sub>2.5</sub> health benefits beginning in 2040 and, overall, a positive present value and annualized value of PM<sub>2.5</sub> health benefits when using a 2 percent and 3 percent discount rate. (See sections V and VII of this preamble and Chapters 4 and 7 of the RIA for more detail). EPA believes the non-GHG emissions reductions of this rule provide important health benefits to the 72 million people living near truck routes and even more broadly over the longer term. We note that the agency has broad authority to regulate emissions from the power sector (e.g., the mercury and air toxics standards, and new source performance standards), as do the States and EPA through cooperative federalism programs (e.g., in response to PM NAAQS implementation requirements, interstate transport, emission guidelines, and regional haze),<sup>817</sup> and that EPA reasonably may address air pollution incrementally across multiple rulemakings, particularly across multiple industry sectors. For example, EPA has separately proposed new source performance standards and emission guidelines for greenhouse gas emissions from fossil fuel-fired power plants, which would also reduce emissions of criteria air pollutants such as PM<sub>2.5</sub> and SO<sub>2</sub> (88 FR 33240, May 23, 2023).<sup>818</sup>

As also explained in section II.G.3, and as discussed in section VII, we monetize benefits of the final standards and evaluate other costs in part to better enable a comparison of costs and benefits pursuant to E.O. 12866, but we recognize that there are benefits we are unable to fully quantify. As noted, EPA's consistent practice has been to set standards to achieve improved air quality consistent with CAA section 202(a), and not to rely on cost-benefit calculations, with their uncertainties and limitations, in identifying the appropriate standards. Such analysis, however, can be corroborative of a standard's reasonableness, as is the case here and as is explained further in this section.

EPA also evaluated the impacts of the final HD GHG standards on energy, in

terms of oil conservation and energy security through reductions in fuel consumption. This final rule is projected to reduce U.S. oil imports by 3 billion barrels through 2055 (see RIA Chapter 6.5). EPA considered the impacts of this projected reduction in fuel consumption on energy security, specifically the avoided costs of macroeconomic disruption. Promoting energy independence and security through reducing demand for refined petroleum use by motor vehicles has long been a goal of both Congress and the Executive Branch because of both the economic and national security benefits of reduced dependence on imported oil, and was an important reason for amendments to the Clean Air Act in 1990, 2005, and 2007.<sup>819</sup> A reduction of U.S. net petroleum imports reduces both financial and strategic risks caused by potential sudden disruptions in the supply of petroleum to the U.S., thus increasing U.S. energy security. EPA finds this rule to have significant benefits from an energy security perspective. We estimate the benefits due to reductions in energy security externalities caused by U.S. petroleum consumption and imports will be approximately \$0.45 billion under the final program. EPA considers this final rule to be beneficial from an energy security perspective and thus this factor was considered to be a supportive and not constraining consideration.

EPA estimates that the annualized value of monetized net benefits to

<sup>819</sup> See e.g., 136 Cong. Rec. 11989 (May 23, 1990) (Rep. Waxman stating that clean fuel vehicles program is "tremendously significant as well for our national security. We are overly dependent on oil as a monopoly; we need to run our cars on alternative fuels."); Remarks by President George W. Bush upon signing Energy Policy Act of 2005, 2005 U.S.C.C.A.N. S19, 2005 WL 3693179 ("It's an economic bill, but as [Sen. Pete Domenici] mentioned, it's also a national security bill. . . . Energy conservation is more than a private virtue; it's a public virtue"); Energy Independence and Security Act, Public Law 110-140, section 806 (finding "the production of transportation fuels from renewable energy would help the United States meet rapidly growing domestic and global energy demands, reduce the dependence of the United States on energy imported from volatile regions of the world that are politically unstable, stabilize the cost and availability of energy, and safeguard the economy and security of the United States"); Statement by George W. Bush upon signing, 2007 U.S.C.C.A.N. S25, 2007 WL 4984165 ("One of the most serious long-term challenges facing our country is dependence on oil—especially oil from foreign lands. It's a serious challenge. . . . Because this dependence harms us economically through high and volatile prices at the gas pump; dependence creates pollution and contributes to greenhouse gas admissions [sic]. It threatens our national security by making us vulnerable to hostile regimes in unstable regions of the world. It makes us vulnerable to terrorists who might attack oil infrastructure.").

society at a 2 percent discount rate will be approximately \$13 billion through the year 2055, roughly 12 times the projected cost in vehicle technology and associated electric vehicle supply equipment (EVSE) combined under the potential compliance pathway. Regarding social costs, EPA estimates that the projected cost of vehicle technology (not including the vehicle or battery tax credits) and EVSE under the potential compliance pathway will be approximately \$1.1 billion, and that the HD industry will save approximately \$3.5 billion in operating costs (e.g., savings that come from less liquid fuel used, lower maintenance and repair costs for ZEV technologies as compared to ICE technologies, etc.). In other words, the social costs of the rule result in net savings to society due largely to the operating savings expected from electrification technologies. The program will result in significant social benefits including \$10 billion in climate benefits (with the average SC-GHGs under a 2 percent near-term Ramsey discount rate) and \$0.3 billion of the estimated total benefits through 2055 are attributable to reduced emissions of non-GHG pollutants. Finally, the benefits due to reductions in energy security externalities caused by U.S. petroleum consumption and imports will be approximately \$0.45 billion under the final program. A more detailed description and breakdown of these benefits can be found in section VIII of the preamble and Chapter 7 of the RIA.

As explained in preamble sections I and II, when section 202(a) requires EPA to consider costs, it is referring to costs to manufacturers, not total social costs. The Administrator identified the standards that he finds appropriate taking into account emissions reductions, costs to manufacturers, feasibility and other required and discretionary factors. As discussed in section VII, we monetize benefits of the final CO<sub>2</sub> emission standards and evaluate other costs in part to better enable a comparison of costs and benefits pursuant to E.O. 12866, but we recognize that there are benefits we are unable to fully quantify. EPA's consistent practice has been to set standards to achieve improved air quality consistent with CAA section 202 and not to rely on cost-benefit calculations, with their uncertainties and limitations, in identifying the appropriate standards. Nonetheless, our estimated benefits, which exceed the estimated costs of the final program, reinforce our view that the final standards represent an appropriate

<sup>817</sup> See also CAA 116.

<sup>818</sup> <https://www.epa.gov/stationary-sources-air-pollution/nsps-ghg-emissions-new-modified-and-reconstructed-electric-utility>.

weighing of the statutory factors and other relevant considerations. More specifically, for this rule our assessment that the rule has positive net monetized benefits supports our view that the final standards represent an appropriate weighing of the statutory factors and other relevant considerations. Positive monetized net benefits do not depend on which of the final rule's discounted stream of PM<sub>2.5</sub> health benefits is used, or as explained in this preamble section II.G whether the final rule's SC-GHG estimates or the IWG SC-GHG estimates are used (see the Appendix to Chapter 8 of the RIA for the latter in the final rule); EPA finds the emissions reductions, in light of the cost of compliance, available lead time and other factors, justify adoption of these standards. Section 202(a)(4)(A) of the CAA specifically prohibits the use of an emission control device, system or element of design that will cause or contribute to an unreasonable risk to public health, welfare, or safety. EPA has a long history of considering the safety implications of its emission standards, from 1980 regulations establishing criteria pollutant standards<sup>820</sup> up to and including the HD Phase 1 and Phase 2 rules. We highlight the numerous industry standards and safety protocols that exist today for heavy-duty BEVs and FCEVs that provide guidance on the safe design of these vehicles in section II.D and RIA Chapter 1 and thus this factor was considered to be a supportive and not constraining consideration.

5. Selection of Final Standards Under CAA 202(a)(1)–(2)

Under section 202(a)(1)–(2), EPA has a statutory obligation to set standards to reduce emissions of air pollutants from classes of motor vehicles that the Administrator has found contribute to air pollution that may be expected to endanger public health and welfare. In setting such standards, the Administrator must provide adequate lead time for the development and application of technology to meet the standards, taking into consideration the cost of compliance. EPA's final standards properly implement this statutory provision, as discussed in this section II.G. In setting standards for a future model year, EPA considers the extent deployment of advanced technologies, including those with the largest potential emission reductions, would be available and warranted in

light of the benefits to public health and welfare in GHG emission reductions, and potential constraints, such as cost of compliance, lead time, raw material availability and component supplies (including availability of minerals critical to lithium-ion battery manufacture and resiliency of associated supply chains), redesign cycles, charging and refueling infrastructure availability and cost, and purchasers' willingness to purchase (including payback). The extent of these potential constraints for the potential compliance pathway demonstrating the feasibility of the final standards has diminished significantly in light of increased and further projected investment by manufacturers, increased and further projected acceptance by purchasers, and significant support from Congress to address such areas as upfront purchase price, charging infrastructure, critical mineral supplies, and domestic supply chain manufacturing. However, as discussed through this preamble section II and RIA Chapter 2, EPA has also given consideration to expressed concerns and uncertainties regarding several aspects of our analysis and undertaken a conservative approach in several of those specific instances, leading to a moderate, balanced approach overall. Examples include analyzing availability and timing of distribution grid buildout without considering measures by which users can mitigate the need for electrification support (see RTC section 7 (Distribution)), selecting 2,000 cycles as our maximum number of cycles for 10 years of battery age (see RIA Chapter 2.4.1.1.3), and use of maintenance and repair scaling factors commencing in MY 2027 and MY 2030 (see preamble section II.E.5). The final standards will achieve significant and important reductions in GHG emissions that endanger public health and welfare. Furthermore, as discussed throughout this preamble, the emission reduction technologies needed to meet the final standards have already been developed and are feasible and available for manufacturers to utilize in their fleets at reasonable cost in the timeframe of these final standards, even after considering key elements including battery manufacturing capacity, critical minerals availability, and timely availability of supporting infrastructure for charging and refueling.

As discussed throughout this preamble, the emission reduction technologies needed to meet the final standards are feasible and available for manufacturers to utilize in HD vehicles in the timeframe of these final

standards. The final emission standards are based on one potential compliance pathway (represented in multiple projected technology packages for the various HD vehicle regulatory subcategories per MY) that includes adoption rates for both certain vehicles with ICE technologies and zero-emission vehicle technologies that EPA regards as feasible and appropriate under CAA section 202(a) for the reasons given in this section II.G, and as further discussed throughout section II and RIA Chapter 2. For the reasons described in that analysis, EPA believes these technologies can be developed and applied in HD vehicles and adopted at the projected rates for these final standards within the lead time provided, as discussed in section II.F and in RIA Chapter 2. EPA's analysis in preamble section II.F.4 further supports the feasibility of the final standards by showing that such GHG emission reductions can be achieved using different mixes of vehicles with ICE technologies, including without producing additional ZEVs to comply with this rule as described in the additional example potential compliance pathway.

EPA also gave appropriate consideration of cost of compliance in the selection of the final standards as described in this section II.G, and as further discussed in section II.F and RIA Chapter 2. The final MY 2027 through MY 2031 emission standards are less stringent than those proposed for those MYs and the final MY 2032 standards; correspondingly, the modeled potential compliance pathway supporting the feasibility of these final standards includes less aggressive application rates and, therefore, is projected to have lower technology package costs than the proposed MY 2027 through MY 2031 emissions standards and the final MY 2032 standards. Additionally, as described in this section II.G and as further discussed in section II.F and RIA Chapter 2, we considered impacts on vehicle purchasers and willingness to purchase (including payback and costs to vehicle purchasers) in applying constraints in our analysis and selecting the final standards.<sup>821</sup> For example, in

<sup>821</sup> EPA has considered purchaser response in appropriately exercising our authority under the statute, and based on the record before us, the agency views purchaser response as a material aspect of the real-world feasibility of the final standards. EPA has a vested interest in real-world feasibility of the final standards as, for example, if the vehicles with advanced technologies are not purchased, the projected emission benefits of the final standards may not occur. Although certain commenters chastised EPA for considering purchaser response, noting that it is not explicitly enumerated in the statute, EPA believes it is

<sup>820</sup> See, e.g., 45 FR 14503 (March 5, 1980) ("EPA would not require a particulate control technology that was known to involve serious safety problems.").

MY 2032, we estimated that the incremental cost to purchase a ZEV will be recovered in the form of operational savings during the first one to four years of ownership, on average by regulatory group, for the vocational vehicles; approximately two years, on average by regulatory group, for short-haul tractors; and four years, on average by regulatory group, for long-haul tractors, as shown in the payback analysis included in section II.F.1. We find the technologies will pay for themselves on average by regulatory group within the ownership timeframe for both tractors and vocational vehicles, as described in section II.F.1.

Moreover, averaging and the additional flexibilities beyond averaging already available under EPA's existing regulations, including banking and trading provisions in the ABT program—which, for example, in effect enable manufacturers to spread the compliance requirement for any particular model year across multiple model years—further support EPA's conclusion that the final standards provide sufficient time for the development and application of technology, giving appropriate consideration to cost.

Congress directed the Administrator to weigh various factors under CAA section 202, and, as with the HD GHG Phase 1 and Phase 2 rules, the Administrator notes that the primary purpose of adopting standards under that provision of the Clean Air Act is to address air pollution that may reasonably be anticipated to endanger public health and welfare and that reducing air pollution has traditionally been the focus of such standards. Taking into consideration the importance of reducing GHG emissions and the primary purpose of CAA section 202 to reduce the threat posed to human health and the environment by air pollution which endangers, the Administrator finds it is appropriate to finalize standards that, when implemented, will result in meaningful reductions of HD vehicle GHG emissions both near term and over the longer term, and to select such standards taking into consideration the enumerated statutory factors of technological feasibility and cost of compliance within the available lead time, as well as the relevant discretionary factor of impacts on purchasers and willingness to purchase. In identifying the final standards, EPA's goal was to balance the emissions reductions given our assessment of

technological feasibility and accounting for cost of compliance, lead time, and purchaser costs and willingness to purchase, and the constraining uncertainties related to each of these elements.

There have been very significant developments in the utilization of ZEV technologies since EPA promulgated the HD GHG Phase 2 rule. One of the most significant developments for U.S. heavy-duty manufacturers and purchasers is the adoption of the IRA, which takes a comprehensive approach to addressing many of the potential barriers to wider adoption of heavy-duty ZEVs in the United States. As noted in RIA Chapter 2, the IRA provides tens of billions of dollars in tax credits and direct Federal funding to reduce the upfront cost of purchasing ZEVs, to increase the number of charging stations across the country, to reduce the cost of manufacturing batteries, and to promote domestic source of critical minerals and other important elements of the ZEV supply chain. By addressing all of these potential obstacles to wider ZEV adoption in a coordinated, well-financed, strategy, Congress significantly advanced the potential for ZEV adoption in the near term, thus supporting standards supported by a potential compliance pathway which includes ZEV technologies.

In developing the modeled potential compliance pathway, EPA considered a variety of constraints which have to date limited utilization of ZEV technologies and/or could limit it in the future, including the following: cost to manufacturers and purchasers; availability of critical minerals; adequacy of battery production and necessary supply chain elements; adequate electricity supply and distribution infrastructure in support of depot and public charging; and availability of hydrogen and supporting infrastructure for its deployment in FCEVs. While EPA acknowledges that there are some factual uncertainties regarding future projections on these constraints, as detailed through the preamble and the accompanying RIA, our analysis recognizes these uncertainties and identifies the considerations the agency found persuasive. Our analysis was informed by extensive consultation with analysts from other agencies, including the Federal Energy Regulatory Commission, DOE, DOT, and the Joint Office of Energy and Transportation. We have extensively reviewed published literature and other data. As discussed in this preamble and the accompanying RIA, we have incorporated limitations into our modeling to address these

potential constraints, as we have assessed are appropriate.

As discussed in section II.G.4, there are additional considerations that support, but were not used to select, the final standards. These include the non-GHG emission and energy impacts, energy security, safety, and net benefits. EPA estimates that the annualized value of monetized net benefits to society at a 2 percent discount rate will be approximately \$13 billion through the year 2055, more than 11 times the cost in vehicle technology and associated electric vehicle supply equipment (EVSE) combined (see preamble section VII and Chapter 8 of the RIA). We recognize these estimates do not reflect unquantified benefits, which would be greater still, and the Administrator has not relied on these estimates in identifying the appropriate standards under CAA section 202(a)(1)–(2). Nonetheless, our conclusion that the estimated benefits exceed the estimated costs of the final program reinforces our view that the final standards represent an appropriate weighing of the statutory factors and other relevant considerations.

As we explained in the HD Phase 3 NPRM, we also considered, but did not analyze, and requested comment on a more stringent alternative with emission standards similar to those required by the CA ACT program. We received a number of comments supporting more stringent standards, as discussed in section II.B. We are not adopting such standards. First, at this time and for similar reasons to those explained in this section II regarding changes made in the final standards from the proposed standards' level of stringency, we consider the final standards' stringency as the appropriate balancing of the factors. Second, the Phase 3 standards demonstrably achieve reductions of GHG emissions beyond those attributable to a "no action" scenario (including the ACT standards), and include significant reductions in non-ACT states. See preamble section V and RTC section 2.4 and sources there cited. We thus do not accept the comment that standards more stringent than those proposed are necessary to achieve reductions beyond those which would occur in the absence of Federal standards. Third, our modeled potential compliance pathway supporting feasibility of the final standards appropriately reflects that ICE vehicles will continue to be needed for certain applications, and for certain usage and weather conditions. The caps on ZEV adoption in our HD TRUCS analysis for the modeled potential compliance pathway properly reflect these

properly considered in this rulemaking as an aspect of both cost (including costs to manufacturers of having stranded assets) and feasibility.

considerations. We do not agree with commenters advocating for more stringent standards reflecting further improvements to ICE vehicles and engines beyond the Phase 2 MY 2027 improvements in our modeled compliance pathway, as our assessment is that manufacturers do not have the resources to use all the different technology improvement strategies together within the lead time provided by the Phase 3 program (e.g., the modeled potential compliance pathway technologies plus technologies in an additional example potential compliance pathway discussed in preamble section II.F.4). See RTC section 2.4.

Fourth, consideration of availability and timing of distribution grid buildout infrastructure, availability of critical minerals and associated issues, and willingness to purchase all warrant a balanced and measured approach in determining the stringency of these standards. Thus, the standards are carefully phased in so that the standards for the initial years of the Phase 3 standards are less stringent, Phase 3 standards for certain vocational vehicles and tractors commence in post-2027 model years, and the standards provide longer lead time where public charging is part of the modeled potential compliance pathway. We believe that these decisions reflect reasoned consideration of feasibility and lead time, appropriately giving these considerations more weight than these commenters would. See RTC section 2.4 for additional responses. In addition to our final standards, we also considered an alternative less stringent than our final standards, as specified and discussed in sections II.H and IX. We considered an alternative with a slower phase-in and with less stringent CO<sub>2</sub> emission standards; however, we did not select this level for the final standards because our assessment in this final rule is that feasible and appropriate standards are available that provide for greater GHG emission reductions than would be provided by this slower phase-in alternative.

We acknowledge that both those stakeholders pressing for more and less rapid increases in stringency have submitted considerable technical studies in support of their positions, including analyses purportedly demonstrating that a more or less rapid adoption of emissions reduction technologies, including zero-emissions technologies, is feasible. These studies account for the vast range of economic, technology, regulatory, and other factors described throughout this preamble; draw different assumptions about key

variables; and reach very different conclusions. We have carefully reviewed all these studies and further discuss them in the RIA and the RTC. The agency's final standards are premised upon our own extensive technical assessment, which in turn is based on a wide review of the literature and test data, extensive expertise with the industry and with implementation of past standards, peer review, and our modeling analyses. The data and resulting modeling demonstrate a balanced and measured rate of adoption of emission reduction technologies, at rates bounded between the higher and lower rates in studies provided by commenters.

On balance, we think the various comments and studies pressing for faster or slower increases in stringency than the final rule each have their strengths and weaknesses, and we recognize the inherent uncertainties associated with predicting the future of the highly dynamic vehicle and related industries up to eight years from today through MY 2032. This uncertainty pervades both scenarios with lesser and greater increases in stringency than the final standards. For example, slower increases in stringency would be more certainly feasible and less costly for manufacturers, but they would also risk giving up emissions reductions and consequent benefits to public health and welfare that are actually achievable. By contrast, faster increases in stringency would aim to achieve greater emissions reductions and consequent benefits for public health and welfare, but they would also run the risk of incurring greater costs of compliance and potentially being infeasible in light of the lead time provided. The final standards reflect our technical expertise in discerning a reasoned path among the varying sources of data, analyses, and other evidence we have considered, as well as the Administrator's policy judgment as to the appropriate level of emissions reductions that can be achieved at a reasonable cost in the available lead time.

While the final standards are more stringent than the Phase 2 standards, EPA applied numerous conservative approaches throughout our analysis (as identified throughout this section II and in RIA Chapter 2) and the final standards additionally are less stringent than those proposed for the first several years of implementation leading to MY 2032. As explained throughout this document, EPA has assessed the appropriateness and feasibility of these standards taking into consideration the potential benefits to public health and welfare, existing market trends and

financial incentives for ZEV adoption, and constraints which could shape technology adoption in the future, including: cost to manufacturers and purchasers; lead time for manufacturers to develop new products to meet a diverse set of HD applications; availability of raw materials, batteries, and other necessary supply chain elements; and adequate charging and refueling infrastructure, electricity supply and distribution. As a result of re-evaluating data and analyses in light of public comments, we have revised both our cost estimates and our assessment of the feasibility of more stringent standards, particularly for the early years of the program. For the years the agency is setting standards, we find it is important for the standards to provide a degree of certainty and send appropriate market signals to facilitate the anticipated investments, not only in technology adoption but also in complementary areas such as supply chains and charging and refueling infrastructure. The Administrator concludes that this balanced and measured approach is within the authority Congress provided under and is consistent with the text and purpose of CAA section 202(a)(1)–(2).

In summary, after consideration of the very significant reductions in GHG emissions, given the technical feasibility of the final standards and the moderate costs per vehicle in the available lead time, and taking into account a number of other factors such as the savings to purchasers in operating costs over the lifetime of the vehicle, safety, the benefits for energy security, and the significantly greater quantified benefits compared to quantified costs, EPA believes that the final standards are appropriate under EPA's section 202(a)(1)–(2) authority.

#### H. Alternatives Considered

Our analysis for the final rule of relevant existing information, public comments, and new information that became available between the proposal and final rule supports a slower implementation than included in the proposed standards; our assessment in this final rule, as described in this section II, is that the final standards provide the appropriate speed of implementation, including adequate lead time. In developing this final rule, we also developed and considered an alternative set of less stringent standards and a more gradual phase-in than the final standards in section II.F. The results of the analysis of this alternative are included in section IX of the preamble. In addition, we considered a set of more stringent standards



reflecting levels of stringency that would be achieved from extrapolating the California ACT rule to the national level.

As discussed in section II.F, we considered while developing the final standards that manufacturers choosing a compliance strategy that utilizes ZEV technologies will need time to ramp up ZEV production from the numbers of ZEVs produced today to the higher adoption rates we project may be used to comply with the final standards that begin between three and eight model years from now. Manufacturers will need to conduct research and develop electrified configurations for a diverse

set of applications. They will also need time to conduct durability assessments because downtime is very critical in the heavy-duty market. Furthermore, manufacturers will require time to make new capital investments for the manufacturing of heavy-duty battery cells and packs, motors, and other EV components, along with changing over the vehicle assembly lines to incorporate an electrified powertrain. In addition, the purchasers of HD BEVs will need time to design and install charging infrastructure at their facilities or determine their hydrogen refueling logistics for FCEVs. Therefore, we

developed and considered an alternative that reflects a more gradual phase-in of utilization of such technologies to provide even longer lead time to address such considerations. The alternative CO<sub>2</sub> emission standards shown in Table II-53 and Table II-54. We are not adopting this alternative set of standards in this final rule because, as already described, our assessment is that feasible and appropriate standards are available that provide for greater emission reductions than provided under this alternative, do so at reasonable cost, and provide sufficient lead time.

**Table II-53 Less Stringent Alternative Standards Considered for Vocational Vehicles**

Model Year	Subcategory	CI Light Heavy	CI Medium Heavy	CI Heavy Heavy	SI Light Heavy	SI Medium Heavy
2027	Urban	312	232	269	358	271
	Multi-Purpose	281	212	230	323	245
	Regional	247	196	189	275	225
2028	Urban	294	224	269	340	263
	Multi-Purpose	264	204	230	306	237
	Regional	233	190	189	261	219
2029	Urban	279	217	245	325	256
	Multi-Purpose	251	197	209	293	230
	Regional	221	183	172	249	212
2030	Urban	261	209	237	307	248
	Multi-Purpose	234	190	202	276	223
	Regional	207	177	166	235	206
2031	Urban	242	201	231	288	240
	Multi-Purpose	218	183	198	260	216
	Regional	192	170	163	220	199
2032 and later	Urban	228	194	223	274	233
	Multi-Purpose	205	176	191	247	209
	Regional	180	164	157	208	193

**Table II-54: Less Stringent Alternative Standards Considered for Tractors**

Model Year	Roof Height	Class 7 All Cab Styles	Class 8 Day Cab	Class 8 Sleeper Cab
2027	Low Roof	96.2	73.4	64.1
	Mid Roof	103.4	78.0	69.6
	High Roof	100.0	75.7	64.3
2028	Low Roof	89.5	68.3	64.1
	Mid Roof	96.2	72.5	69.6
	High Roof	93.0	70.4	64.3
2029	Low Roof	86.6	66.1	64.1
	Mid Roof	93.1	70.2	69.6
	High Roof	90.0	68.1	64.3
2030	Low Roof	82.7	63.1	60.9
	Mid Roof	88.9	67.1	66.1
	High Roof	86.0	65.1	61.1
2031	Low Roof	79.8	60.9	57.7
	Mid Roof	85.8	64.7	62.6
	High Roof	83.0	62.8	57.9
2032 and later	Low Roof	76.0	58.0	54.5
	Mid Roof	81.7	61.6	59.2
	High Roof	79.0	59.8	54.7

In the final rule analysis, we also considered standards consistent with levels of stringency that would be achieved from the California ACT rule extrapolated to the national level. The

more stringent alternative standards considered are shown in Table II-55 and Table II-56. We are not adopting standards consistent with this more stringent alternative because we

consider the final standards' stringency as the appropriate balancing of the factors, as discussed in section II.G.

**Table II-55: More Stringent Alternative Standards Considered for Vocational Vehicles**

Model Year	Subcategory	CI Light Heavy	CI Medium Heavy	CI Heavy Heavy	SI Light Heavy	SI Medium Heavy
2027	Urban	294	206	215	340	245
	Multi-Purpose	264	188	184	306	221
	Regional	233	174	151	261	203
2028	Urban	257	181	188	303	220
	Multi-Purpose	231	165	161	273	198
	Regional	204	153	132	232	182
2029	Urban	220	155	161	266	194
	Multi-Purpose	198	141	138	240	174
	Regional	175	131	113	203	160
2030	Urban	184	129	135	230	168
	Multi-Purpose	165	118	115	207	151
	Regional	146	109	95	174	138
2031	Urban	165	116	121	211	155
	Multi-Purpose	149	106	104	191	139
	Regional	131	98	85	159	127
2032 and later	Urban	147	103	108	193	142
	Multi-Purpose	132	94	92	174	127
	Regional	116	87	76	144	116

**Table II-56: More Stringent Alternative Standards Considered for Tractors**

Model Year	Roof Height	Class 7 All Cab Styles	Class 8 Day Cab	Class 8 Sleeper Cab
2027	Low Roof	81.8	62.4	54.5
	Mid Roof	87.9	66.3	59.2
	High Roof	85.0	64.3	54.7
2028	Low Roof	77.0	58.7	51.3
	Mid Roof	82.7	62.4	55.7
	High Roof	80.0	60.6	51.4
2029	Low Roof	72.2	55.1	48.1
	Mid Roof	77.6	58.5	52.2
	High Roof	75.0	56.8	48.2
2030	Low Roof	67.3	51.4	44.9
	Mid Roof	72.4	54.6	48.7
	High Roof	70.0	53.0	45.0
2031	Low Roof	62.5	47.7	41.7
	Mid Roof	67.2	50.7	45.2
	High Roof	65.0	49.2	41.8
2032 and later	Low Roof	57.7	44.0	38.5
	Mid Roof	62.0	46.8	41.8
	High Roof	60.0	45.4	38.6

**I. Small Businesses**

As proposed, qualifying small manufacturers will remain subject to the previously promulgated Phase 2 MY 2027 and later GHG vehicle emission standards, and are not subject to the Phase 3 standards unless they voluntarily decide to opt into the Phase 3 program, as discussed in this section (see 40 CFR 1037.105(b) and (h) and 1037.106(b)).<sup>822</sup> We note that this approach avoids any potential undue burden on these small entities. See 88 FR 26008. EPA may consider new GHG emission standards to apply for vehicles produced by small business vehicle manufacturers as part of a future regulatory action.

As described in RIA Chapter 9, we have identified a small number of heavy-duty vehicle manufacturers that would qualify as small manufacturers under the heavy-duty vehicle manufacturer category. Most of these small businesses currently only produce ZEVs, while one company currently produces ICE vehicles.<sup>823</sup> We thus estimate that there would only be a small emissions benefit from applying the final standards to the relatively low production volume of ICE vehicles produced by small businesses and maintaining the previously promulgated HD vehicle CO<sub>2</sub> standards for these

companies at this time would have a negligible impact on the overall GHG emission reductions that the program would otherwise achieve. We received no comments on our proposal to retain the MY 2027 and later standards for qualifying manufacturers or revise the definition of small manufacturer. The Phase 2 standards will continue to apply and any applicable small manufacturer flexibilities established under the Phase 2 program will continue to be available to small manufacturers for MY 2027 and later.

Since the Phase 2 standards are also based on a fleet average, small manufacturers can continue to average within their averaging sets to achieve the applicable standards. However, we proposed to restrict banking, trading, and the use of advanced technology credit multipliers for credits generated against the Phase 2 standards for qualifying manufacturers that utilize this small business interim provision. Under this final rule, and as explained in the proposal, qualifying small manufacturers may voluntarily certify their vehicles to the Phase 3 standards without ABT participation restrictions if they certify all their vehicle families within a given averaging set to the Phase 3 standards for the given MY. In other words, small manufacturers that opt into the Phase 3 program for a given MY for all their vehicle families within a given averaging set would be eligible for the full ABT program, including the expanded flexibilities finalized in this rule as described in section III.A.

While the new Phase 3 standards do not apply for vehicles produced by qualifying small manufacturers, we proposed and are finalizing that small manufacturers that are certifying BEVs or FCEVs would be subject to the battery durability monitor and warranty provisions described in section III.B.

**III. Compliance Provisions, Flexibilities, and Test Procedures**

In this rule, we are retaining the general compliance structure of existing 40 CFR part 1037 with some revisions described in this section. Vehicle manufacturers will continue to demonstrate that they meet emission standards using emission modeling and EPA’s Greenhouse gas Emissions Model (GEM) and will use fuel-mapping or powertrain test information from procedures established and revised in previous rulemakings.<sup>824</sup>

In section III.A, we describe the general ABT program, discrete revisions to it which we are finalizing, and how we expect manufacturers to utilize ABT to meet the final standards. In section III.A.1, we describe a revision to the

<sup>824</sup> See the HD GHG Phase 2 rule (81 FR 73478, October 25, 2016), the Heavy-Duty Engine and Vehicle Technical Amendment rule (86 FR 34308, June 29, 2021), and the HD2027 rule (88 FR 4296, January 24, 2023). As also explained in the proposal for this rulemaking, in this rulemaking EPA did not reopen any portion of our heavy-duty compliance provisions, flexibilities, and testing procedures, including those in 40 CFR parts 1037, 1036, and 1065, other than those specifically identified in the proposal as the subject of our proposal or a solicitation for comment. For example, while EPA is finalizing revisions to discrete elements of the HD ABT program, EPA did not reopen the general availability of ABT.

<sup>822</sup> See section III.C of this preamble for a description of the final revisions to the provisions for small manufacturers in 40 CFR 1037.105(b) and (h), 1037.106(b), and 1037.150(c) and (w).

<sup>823</sup> See section XI.C of this preamble for our regulatory flexibility assessment of the potential burden on small businesses.

definition of “U.S.-directed production volume” that clarifies consideration in this rulemaking of nationwide production volumes, including those that may be certified to different state emission standards.<sup>825</sup> This revised definition addresses the interaction that would otherwise result between the previous definition of U.S.-directed production volume and the California Advanced Clean Truck (ACT) regulation for HD vehicles.<sup>826</sup> Section III.A.2 includes updates to advanced technology credit provisions after considering comments received on the HD2027 NPRM (87 FR 17592, March 28, 2022) and the proposal for this rulemaking (88 FR 25926, April 27, 2023). In section III.A.3, we describe other revised flexibilities available to heavy-duty vehicle manufacturers, including an interim transitional flexibility regarding how credits could be used across averaging sets. In section III.B, we describe new durability monitoring requirements for BEVs and PHEVs, clarify existing warranty requirements for PHEVs, and describe new warranty requirements for BEVs and FCEVs. Finally, section III.C includes additional clarifying and editorial amendments we are finalizing related to the HD highway engine provisions of 40 CFR part 1036, the HD vehicle provisions of 40 CFR part 1037, the test procedures for HD engines in 40 CFR part 1065, and provisions that span multiple sectors.

*A. Revisions to the ABT Program*

The existing HD GHG Phase 2 program provides flexibilities, primarily through the HD GHG ABT program, that facilitate compliance with the emission standards. In the HD space, our use of averaging dates back to our 1985 emissions standards for highway HD engines. 50 FR 10606 (March 15, 1985) (“Emissions averaging, of both particulate and oxides of nitrogen emissions from heavy-duty engines, is allowed beginning with the 1991 model year. Averaging of NO<sub>x</sub> emissions from light-duty trucks is allowed beginning in 1988.”). Similarly, we have included banking and trading for highway HD engines in our rules dating back to 1990. 55 FR 30584 (July 26, 1990) (“This final rule announces new programs for banking and trading of particulate matter and oxides of nitrogen emission credits for gasoline-, diesel- and

methanol-powered heavy-duty engines.”). See section I of this preamble for a summary of EPA’s authority and implementation of ABT in previous rulemakings, and a more detailed description in response to comments on our authority in RTC section 10.2.1.

EPA considered averaging and the existence of the general ABT program as part of the Phase 2 standard setting process (see, e.g., 81 FR 73495 (October 25, 2016)). As explained in section II, we likewise considered averaging in the standard setting process of the Phase 3 GHG standards, and our assessment is premised upon the availability of averaging in supporting the feasibility of the final standards. While we also considered the existence of other aspects of the ABT program as supportive of the feasibility of the Phase 3 GHG standards, we did not rely on those other aspects in justifying the feasibility of the standards. In other words, the existing ABT program will continue to help provide additional flexibility in compliance for manufacturers to make necessary technological improvements and reduce the overall cost of the program, without compromising overall environmental objectives; however, the other aspects of the ABT program that are not the availability of averaging, including credit carryover, deficits, banking, and trading, were not considered in setting the numeric levels of the Phase 3 standards. Accordingly, these other aspects of ABT are severable from the Phase 3 standards.

The current HD GHG Phase 2 program also includes specific credit provisions for “advanced technologies” as identified in the Phase 2 rule (i.e., PHEVs, BEVs, and FCEVs) and separate provisions for other innovative technologies that are not reflected in GEM. As described in section II of this preamble, the revisions to the existing MY 2027 Phase 2 GHG emission standards and new standards for MYs 2028 through 2032 are supported by a modeled potential compliance pathway premised on utilization of a variety of technologies, including technologies that are considered advanced technologies in the existing HD GHG Phase 2 ABT program.<sup>827</sup>

We are generally retaining and did not reopen the existing HD GHG Phase 2 ABT program that allows for emission credits to be averaged, banked, or traded within each of the averaging sets

specified in existing 40 CFR 1037.740(a). We provide the following description of the existing ABT program for background and informational purposes only.<sup>828</sup> In brief, under the existing program, manufacturers may choose to demonstrate compliance with the applicable emission standard by using the regulatory provisions for averaging, banking, and trading.<sup>829</sup> They do so by dividing their vehicles into “families” or “subfamilies”. For each family or subfamily, the manufacturer must designate a “Family Emission Limit”, which is an “emission level . . . to serve in place of the otherwise applicable emission standard” for each family or subfamily.<sup>830</sup> The designated FEL applies to every vehicle within a family or sub-family and must be complied with throughout the vehicle’s useful life. Manufacturers choosing to demonstrate compliance with the applicable emission standards using the ABT program must show compliance based on (among other things) production levels and emissions level of FELs. See 40 CFR 1037.705(b). Each family or subfamily has a designated FEL, and credits are generated if the FEL is lower than the applicable standard, and debits are generated if the FEL is higher than the applicable standard.<sup>831</sup> The manufacturer can use those credits to offset higher emission levels from vehicles in the same averaging set such that the averaging set meets the standards on “average”, “bank” the credits for later use, or “trade” the credits to another manufacturer. In other words, under the existing ABT program, a manufacturer has two obligations—(1) all vehicles are certified to and must comply throughout their useful life with the FEL applicable to that vehicle’s family or subfamily, and (2) the manufacturer’s vehicles must comply with the applicable emission standard as a group, e.g., using a production-weighted average of the various FELs across the applicable averaging set. All vehicle families across an averaging set must show a net zero or positive credit balance as detailed in the existing regulation.<sup>832</sup> To incentivize the

<sup>828</sup> See also an expanded description of EPA’s ABT program provided as background in the HD GHG Phase 1 rule (76 FR 57238–57243).

<sup>829</sup> 40 CFR 1037.241(a)(2).

<sup>830</sup> 40 CFR 1037.801 (definition of “Family emission limit”).

<sup>831</sup> “[F]or each family or subfamily . . . positive credits [are generated] for a family or subfamily that has an FEL below the standard.” 40 CFR 1037.705(b).

<sup>832</sup> Manufacturers must show “that [the manufacturer’s] net balance of emission credits from all [the manufacturer’s] participating vehicle families in each averaging set is not negative”. 40 CFR 1037.730(c)(1), and 40 CFR 1037.241(a)(2)

<sup>825</sup> The definition update includes conforming amendments throughout the HD engine and vehicle regulations of 40 CFR parts 1036 and 1037, respectively.

<sup>826</sup> EPA granted the ACT rule waiver requested by California under CAA section 209(b) on March 30, 2023.

<sup>827</sup> As stated in the proposal, we are retaining and did not reopen the existing off-cycle provisions of 40 CFR 1037.610 that allow manufacturers to request approval for other “innovative” technologies. 88 FR 26013.

research and development of new technologies with great emission reduction potential, the existing HD vehicle ABT program also includes credit multipliers for certain advanced technologies, which we discuss further in III.A.2.

In this section III.A, we describe changes we are finalizing for three aspects of the ABT program: the applicable production volume for use in calculating ABT credits, how manufacturers can use credit multipliers for advanced technologies, and credit transfers across averaging sets. We intend for the limitations placed on credits generated from Phase 2 advanced technology credit multipliers and the transitional allowance of credit transfers across averaging sets that are finalized in this rule to be entirely separate from the Phase 3 emissions standards and other varied components of this rule, and severable from each other. Each of these two issues has been considered and adopted independently of the level of the standards, and indeed of each other. EPA's overall vehicle program continues to be fully implementable even in the absence of any one or both of these elements. All the emissions standards in the rule are feasible even without these specific flexibilities. While credits from multipliers and credit transfers across averaging sets allow flexibility in compliance options for manufacturers, they are not necessary for manufacturers to meet the emissions standards and we did not rely on them in justifying the feasibility of the standards. See preamble sections II.F and II.G and RIA Chapter 2. EPA has also considered and adopted these transitional ABT flexibilities and requirements and the remaining portions of the final rule independently, and each is severable should there be judicial review. If a court were to invalidate any one of these elements of the final rule, we intend the remainder of this action to remain effective, as we have designed the program to function even if one part of the rule is set aside. For example, if a reviewing court were to invalidate the transitional allowance of credit transfers across averaging sets, the other components of the rule, including the Phase 3 GHG standards (which are not predicated on these transitional flexibilities), remain fully operable. We did not propose or otherwise reopen, and we are not adopting any revisions

(“vehicle families within an averaging set are considered in compliance with the CO<sub>2</sub> emissions standards, if the sum of positive and negative credits for all vehicle configurations in those vehicles lead to a zero balance or a positive balance of credits”).

to the allowance that provides manufacturers three years to resolve credit deficits, as detailed in 40 CFR 1037.745. We did not reopen and are generally retaining the existing credit life of five years, as described in 40 CFR 1037.740(c), with discrete revisions beginning in MY 2027 to the availability of credits earned from advanced technology multipliers as described in section III.A.2. Similarly, we are retaining the existing ABT restrictions for vehicles certified to the custom chassis standards in 40 CFR 1037.105(h)(2). Manufacturers of custom chassis vehicles that wish to make use of the expanded flexibilities we are finalizing in this rule and describing in this section III.A, must certify the vehicles under the main program in the applicable regulatory subcategory.

#### 1. U.S.-Directed Production Volume

As described in section II.D and II.F, the Phase 3 GHG vehicle standards include consideration of nationwide production volumes. Correspondingly, we proposed and are finalizing that the GHG ABT program for compliance with those standards be applicable to the same production volumes considered in setting the standards. 88 FR 26009. The existing HD GHG Phase 2 vehicle program has certain provisions (based off the regulatory definition of “U.S.-directed production volume”) that would exclude production volumes that are certified to different state emission standards, including exclusion from participation in ABT. To address the interaction between the existing definition of U.S.-directed production volume and the California Advanced Clean Truck (ACT) regulation for HD vehicles, we proposed and are finalizing a revision to the definition of “U.S.-directed production volume” in 40 CFR 1037.801. The revision removes the final sentence of that definition, which presently states that the definition “does not include vehicles certified to state emission standards that are different than the emissions standards in this part”, and thereby amends it to remove any exclusions from the definition. In this section III.A.1, we summarize the approach used to setting the Phase 3 standards and the uncertainties that led us to revise the definition such that, within the Phase 3 standards and within the ABT GHG vehicle program, we consider nationwide production volumes that include vehicles that may be certified to state emission standards that are different than the emission standards in 40 CFR part 1037, including vehicles subject to the ACT standards.

The term U.S.-directed production volume is key in how the regulations direct manufacturers to calculate credits in the HD vehicle ABT GHG program in 40 CFR part 1037, subpart H. As noted, prior to this final rule, the existing definition of “U.S.-directed production volume” for HD vehicles explicitly excludes vehicles certified to state emission standards that differed from Federal standards.<sup>833</sup> Consequently, vehicle production volumes excluded from that term’s definition could not generate credits or deficits for purposes of the Federal program. As described in the proposal (88 FR 26009), the previous exclusion of engines and vehicles certified to different state standards did not impact the HD GHG program under parts 1036 and 1037 to-date because California adopted GHG emission standards for HD engines and vehicles that aligned with the Federal HD GHG Phase 1 and Phase 2 standards.<sup>834 835</sup> As also noted in the proposal, the revised definition would align with the approach in the LD GHG program (88 FR 26010).

As discussed in Chapter 1 of the RIA, the ACT regulation requires manufacturers to produce and sell increasing numbers of zero-emission medium- and heavy-duty highway vehicles. Given the distinct difference between what would be required under the ACT regulation compared to the existing Phase 2 and proposed Phase 3 vehicle standards, we proposed that the new definition would start with MY 2024 to provide consistent treatment of any production volumes certified to ACT. We requested comment on whether we should consider other options to transition to the new definition.

In comments, vehicle manufacturers generally supported the proposed

<sup>833</sup> Previously, 40 CFR 1037.801 defined *U.S.-directed production volume* as meaning “the number of vehicle units, subject to the requirements of this part, produced by a manufacturer for which the manufacturer has a reasonable assurance that sale was or will be made to ultimate purchasers in the United States. This does not include vehicles certified to state emission standards that are different than the emission standards in this part.” An equivalent definition of *U.S.-directed production volume* previously applied for HD engines under 40 CFR 1036.801.

<sup>834</sup> California Air Resources Board. “Final Regulation Order for Phase 1 Greenhouse Gas Regulations.” December 5, 2014, available at <https://ww2.arb.ca.gov/sites/default/files/barcu/regact/2013/hdghg2013/hdghgfrot13.pdf>.

<sup>835</sup> California Air Resources Board. “Final Regulation Order for Phase 2 Greenhouse Gas Regulations and Tractor-Trailer GHG Regulations.” April 1, 2019, available at [https://ww2.arb.ca.gov/sites/default/files/barcu/regact/2018/phase2/finalata.pdf?\\_ga=2.122416523.1825165293.1663635303-1124543041.1635770745](https://ww2.arb.ca.gov/sites/default/files/barcu/regact/2018/phase2/finalata.pdf?_ga=2.122416523.1825165293.1663635303-1124543041.1635770745).

revision to the definition and the effective date of MY 2024, with some indicating that manufacturers would need to include vehicles intended for ACT states in order to meet the Phase 3 standards and that some manufacturers have adopted ZEV technologies as a Phase 2 compliance strategy. Environmental and health NGOs generally opposed the proposed revision noting that, combined with the multipliers available for advanced technology credits in that period, the new definition would erode the Phase 3 standard stringency and result in no improvements beyond what would occur in the absence of the rule. Some of the commenters further suggested that these credits could even dilute the stringency of the Phase 2 standards, without justification, by making the revised definition effective in MY 2024. Consequently, the commenters urged that if EPA amends the definition as proposed, it either commence the change in MY 2027 rather than MY 2024 or that EPA make a corresponding adjustment in stringency of the Phase 3 national standard to include nationwide adoption rates similar to ACT.

We are adopting an amended definition of the term U.S.-directed production volume. We disagree with commenters maintaining that EPA should not change the definition because any credits generated by vehicles in ACT states would be windfalls for the Phase 3 program. First, it is not clear that ZEV sales in ACT states are automatically attributable to the ACT requirements. Manufacturers have already introduced ZEVs into the market and, given that EPA granted the waiver for ACT earlier this year, some may have done so as a Phase 2 compliance strategy.<sup>836</sup> Additionally, it is currently unclear if manufacturers' existing compliance plans to meet the Phase 2 standards in a given model year include use of all or a portion of their advanced technology credits (and associated credit multipliers) generated from nationwide production volumes. Credits generated as a result of legitimate Phase 2 compliance strategies are not windfalls and we do not have a way to accurately project or account for the balance of credits that may be available for use in MYs 2027 and later.

Furthermore, the final standards reflect nationwide production volumes. As explained in section II.F of this

preamble, for the modeled potential compliance pathway supporting the feasibility of the final standards, HD TRUCS uses nationwide production volumes to project the utilization of the ZEV technologies portion of the technology packages.<sup>837</sup> So commenters were mistaken in maintaining that the change in the definition would necessarily dilute the Phase 3 standard stringency, as the final Phase 3 standards' stringency are premised upon nationwide production volumes, consistent with the amended definition.

In response to commenters suggesting EPA adjust the stringency of Phase 3 to include nationwide adoption rates similar to ACT, we note that we developed the final rule stringency through a balanced and measured approach, based on consideration and balancing of the statutory and other relevant factors, including technical feasibility, costs, and lead time, as described in section II.G of this preamble and RTC section 2.4.

We note an additional concern with EPA adopting suggestions from commenters asking EPA to take a different Phase 3 standard setting approach and implement the Federal program with the previous definition. Even under the previous definition, manufacturers should be eligible to generate credits under the Federal program for production and sales in excess of those required by ACT in states where ACT is applicable, as otherwise our Federal program could unintentionally create a disincentive for such excess production and sales in states where ACT applies.<sup>838 839</sup> If the ACT program simply mandated "each manufacturer shall produce x number of vehicles of each type", it would be straightforward to segregate production volumes and sales destined for ACT states and exclude such volumes from standard setting and compliance. But the ACT program is not structured that simply and also provides various compliance flexibilities for manufacturers. For example, it uses a credit generating approach with similarities to the Federal ABT program,

but with consequential differences as well, including weighted amounts of credits per vehicle class, banking and trading across all vehicle classes, the ability to generate partial credits for certain vehicles, and the potential for carrying deficits into future model years. See RIA Chapter 1.3.3 for further detail on the California ACT regulation. Thus, there would be meaningful uncertainties related to segregating manufacturers' production volumes and credit balances to comply with the ACT regulation. While we project a reference case (as explained in section V of this preamble and RIA chapter 4.3.1) that includes an increase in the production of ZEVs in part reflecting compliance with ACT in states where applicable, given the flexibilities in ACT, the production volumes projected in the reference case may not match what manufacturers actually do. It is also unclear how EPA could appropriately distinguish which credits should be treated as excess and part of compliance with the Phase 3 program, and the complexity involved in such a scheme raises verification concerns.

Finally, we do not think it would be appropriate under CAA section 202(a)(1) to support the standards through a feasibility demonstration under the modeled potential compliance pathway projecting that manufacturers will sell volumes of ZEVs nationally (including in ACT states), but then prohibit manufacturers from generating and using credits based on such sales for compliance purposes. This would result in a disconnect between how EPA developed and implemented the standards, as the standard stringency reflects nationwide production volumes but implementation would exclude portions of nationwide sales. In addition, we want to minimize the impact of the uncertainty surrounding the number of states that may adopt the ACT program on manufacturer compliance planning both in the years leading up to MY 2027 and during the years of the Phase 3 program. That is, we think it is important to provide manufacturers with regulatory certainty on the impact of their products on their compliance with the Phase 3 program, and believe that it would be inappropriate for such impacts to change significantly every time a new State decided to adopt (or withdraw from) the ACT program. Furthermore, manufacturers may be motivated to produce vehicles with advanced CO<sub>2</sub> control or prevention technologies by Phase 3 and in response to other initiatives, and we want to support any U.S. adoption of these technologies by

<sup>837</sup> Specifically, the projected ZEV adoption rates in our modeled potential compliance pathway are sales-weighted by subcategory. See RIA Chapter 2 for a more detailed description of HD TRUCS and its use of MOVES 4.0 data, as well as the potential compliance pathway's technology packages.

<sup>838</sup> See comments from Navistar, Inc. (EPA-HQ-OAR-2019-0055-1318, p. 6) submitted to EPA for the HD2027 NPRM (87 FR 17592).

<sup>839</sup> We also considered that exclusion of production volumes and sales of states that adopted ACT from the Federal ABT program could unintentionally complicate or even disincentivize other state's decision making in whether to adopt ACT under CAA section 177.

<sup>836</sup> See, e.g., comments of DTNA (EPA-HQ-OAR-2022-0985-1555) and Volvo (EPA-HQ-OAR-0985-1606) asserting that OEMs have not been adopting certain technologies on which EPA predicated the Phase 2 rule and consequently have looked to other means of compliance, including utilizing ZEV technologies.

allowing manufacturers to account for their nationwide production volumes to comply with the standards of this rule. For these reasons, EPA believes the change to the definition is warranted.

In response to commenters urging that any change not occur until MY 2027, we disagree that this new definition would dilute the Phase 2 program. The Phase 2 standards were promulgated as a national program and we expect manufacturers developed their Phase 2 compliance strategies relying on the availability of credits, and in some case credit multipliers, from nationwide production. As noted, there are comments to this effect from manufacturers. While there are now new state standards and the previous definition would exclude production intended for sale in states adopting those standards, the timing of the ACT waiver approval relative to the manufacturer compliance plans would cause timing concerns in the near term if those production volumes were excluded from Phase 2 compliance.

Also, as just noted, uncertainties relating to other states adopting the ACT regulation and the timing of such adoption can cut across manufacturers' compliance plans, and this concern is especially sensitive in the near term, when manufacturers are least able to alter compliance strategies. For example, with respect to MY 2024, EPA expects that manufacturers have been planning and developing a compliant fleet for years based on the nationwide applicability of the Phase 2 program, including ABT provisions, and the lead time necessary to develop and produce heavy-duty vehicles. EPA granted the CAA section 209 waiver of preemption for the California ACT program on March 30, 2023, which is during MY 2024, and which under the prior definition of U.S.-Directed Production Volume would have caused manufacturers to not be able to generate credits for vehicles sold in states that had adopted ACT.<sup>840</sup> To suddenly deprive manufacturers of the ability to generate credits for vehicles sold in ACT states for MY 2024 during that model year would likely undermine manufacturers' long-extant compliance strategies, and given the lead time

<sup>840</sup> We note again that prior to the adoption of ACT and EPA granting the waiver for ACT, the EPA and California programs were aligned. Thus, as a practical matter, manufacturers could generate credits based on nationwide production volumes, notwithstanding the then-existing definition of "U.S.-directed production volume." From this perspective, EPA's amendment of the definition appropriately preserves the status quo whereby credits may be generated nationwide for compliance through the EPA ABT program. See Response to Comments section 10.2.

necessary for developing and producing vehicles, would not likely cause manufacturers to significantly change their product line in MY 2024.

Thus, we are finalizing a revision to the definition of "U.S.-directed production volume" in 40 CFR 1037.801 such that it represents the total nationwide production volumes, and we are making that change effective in MY 2024 to minimize the uncertainties related to how ACT will be implemented. We explain in the following section III.A.2 that the final rule includes provisions aimed at minimizing emissions impacts of credits from PHEV, BEV, and FCEV production volumes.

Finally, we note that in addition to this revision to the definition of "U.S.-directed production volume", we are finalizing additional conforming amendments throughout 40 CFR part 1037 to streamline references to the revised definition; see section III.C.3 of this preamble for further discussion on one of those revisions.<sup>841</sup>

## 2. Advanced Technology Credit Multipliers for CO<sub>2</sub> Emissions

For the HD GHG Phase 2 rule, EPA adopted credit multipliers through MY 2027 for vehicles that qualified as "advanced technology" based on the administrative record at that time (*i.e.*, PHEV, BEV, and FCEV). In the proposal for this rule (88 FR 26010), we described the HD GHG Phase 2 advanced technology credit multipliers as representing a tradeoff between incentivizing new advanced technologies that could have significant emissions benefits and providing credits that could allow higher emissions from credit-using engines and vehicles. At the time we finalized the HD GHG Phase 2 program in 2016, we estimated that there would be very little market penetration of PHEV, BEV, and FCEV in the heavy-duty market in the MY 2021 to MY 2027 timeframe when the advanced technology credit multipliers would be in effect. Additionally, the technology packages in our technical basis of the feasibility of the HD GHG Phase 2 standards did not include any of these advanced technologies.

In our assessment conducted during the development of HD GHG Phase 2, we found only one manufacturer had certified HD BEVs through MY 2016, and we projected "limited adoption of

<sup>841</sup> As discussed in section III.C.3, we are also finalizing a similar update to the heavy-duty highway engine definition of "U.S.-directed production volume" in 40 CFR 1036.801, with additional updates where it is necessary to continue to exclude production volumes intended for sale in states with different emission standards.

all-electric vehicles into the market" for MYs 2021 through 2027.<sup>842</sup> At low adoption levels, the benefits of encouraging additional utilization of these technologies outweighed negative emissions impacts of multipliers. However, as discussed in section II, manufacturers are now actively increasing their use of PHEV, BEV, and FCEV HD technologies with further support through the IRA and other actions, and we expect this growth to continue through the remaining timeframe for the HD GHG Phase 2 program and into the timeframe for this Phase 3 program.

While we did anticipate that some growth in development of these technologies would occur due to the credit incentives in the HD GHG Phase 2 final rule, we did not expect the level of innovation observed since we finalized the rule, the IRA or BIL incentives, or that California would adopt the ACT rule at the same time these advanced technology multipliers were in effect. We therefore proposed phasing out multipliers for PHEV and BEV technologies one year earlier than provided in the Phase 2 rule. After considering comments and the potential disruption to manufacturers' compliance plans for Phase 2, we are retaining the existing Phase 2 flexibility that allows manufacturers to continue to earn advanced technology credit multipliers for PHEV and BEV technologies through model year 2027. To address the concern of reduced Phase 3 stringency raised in comments, we are finalizing a provision that places certain restrictions on and specifies the circumstances when credits from multipliers may be used in model years 2027 through 2029 and eliminates the availability of credit multipliers for use in model years 2030 and later. In this section III.A.2, we present background on advanced technologies, summarize the comments that informed our final approach for credit multipliers, and describe the revisions we are finalizing related to advanced technology credits.

### i. Background on Phase 1 and Phase 2 GHG Advanced Technology Credits

In the prior HD GHG Phase 1 and Phase 2 rules, EPA adopted advanced technology credits to incentivize the long-term development of technologies that had the potential to achieve very large GHG reductions. Specifically, in HD GHG Phase 1, we provided advanced technology credits for hybrid powertrains, Rankine cycle waste heat recovery systems on engines, all-electric vehicles, and fuel cell electric vehicles

<sup>842</sup> 81 FR 73818 (October 25, 2016).

to promote the implementation of advanced technologies that were not included in our technical basis of the feasibility of the Phase 1 emission standards (see 40 CFR 86.1819–14(k)(7), 1036.150(h), and 1037.150(p)). The HD GHG Phase 2 CO<sub>2</sub> emission standards that followed Phase 1 were premised on the use of mild hybrid powertrains in vocational vehicles and waste heat

recovery systems in a subset of the engines and tractors, and we removed mild hybrid powertrains and waste heat recovery systems as options for advanced technology credits. At the time of the HD GHG Phase 2 final rule in 2016, we believed the HD GHG Phase 2 standards themselves provided sufficient incentive to develop those specific technologies. However, none of

the HD GHG Phase 2 standards were based on projected utilization of the other, even more-advanced Phase 1 advanced credit technologies (e.g., plug-in hybrid electric vehicles, all-electric vehicles, and fuel cell electric vehicles). For HD GHG Phase 2, EPA promulgated advanced technology credit multipliers through MY 2027, as shown in Table III–1 (see also 40 CFR 1037.150(p)).

**Table III-1 Advanced Technology Multipliers in Existing HD GHG Phase 2 for MYs 2021 through 2027**

Technology	Multiplier
Plug-in hybrid electric vehicles	3.5
All-electric vehicles	4.5
Fuel cell electric vehicles	5.5

As stated in the HD GHG Phase 2 rulemaking, our intention with these multipliers was to create a meaningful incentive for those manufacturers considering developing and applying these qualifying advanced technologies into their vehicles. The multipliers under the existing program are consistent with values recommended by CARB in their HD GHG Phase 2 comments.<sup>843</sup> CARB’s values were based on a cost analysis that compared the costs of these advanced technologies to costs of other GHG-reducing technologies. CARB’s cost analysis showed that multipliers in the range we ultimately promulgated as part of the HD GHG Phase 2 final rule would make these advanced technologies more competitive with the other GHG-reducing technologies and could allow manufacturers to more easily generate a viable business case to develop these advanced technologies for HD vehicles and bring them to market at a competitive price.

In establishing the multipliers in the HD GHG Phase 2 final rule, we also considered the tendency of the HD sector to lag behind the light-duty sector in the adoption of several advanced technologies. There are many possible reasons for this, such as:

- HD vehicles are more expensive than light-duty vehicles, which makes it a greater monetary risk for purchasers to invest in new technologies.
- These vehicles are primarily work vehicles, which makes predictable functionality and versatility important.
- Sales volumes are much lower for HD vehicles, especially for specialized vehicles.

At the time of the HD GHG Phase 2 rulemaking, after considering these

factors, combined with virtually non-existent adoption of the aforementioned advanced technologies in HD vehicles as of 2016, we concluded that it was unlikely that market adoption of these low GHG advanced technologies would grow significantly within the next decade without additional incentives.

As we stated in the HD GHG Phase 2 final rule preamble, our determination that it was appropriate to provide large multipliers for these advanced technologies, at least in the short term, was because these advanced technologies have the potential to lead to very large reductions in GHG emissions and fuel consumption and promote technology development substantially in the long term. 81 FR 73818. However, because the credit multipliers are so large, we also stated that they should not necessarily be made available indefinitely. Therefore, they were included in the HD GHG Phase 2 final rule as an interim program continuing only through MY 2027. 40 CFR 1037.615(a).

The HD GHG Phase 2 CO<sub>2</sub> emission credits for HD vehicles are calculated according to the existing regulations at 40 CFR 1037.705(b). For BEVs and FCEVs, the family emission level (FEL) value for CO<sub>2</sub> emissions is deemed to be 0 grams per ton-mile.<sup>844</sup> Under those existing regulations, the CO<sub>2</sub> emission credits for HD BEVs built between MY 2021 and MY 2027 would be multiplied by 4.5 (or the values shown in Table III–1 for the other technologies) and, for discussion purposes, can be visualized as split into two shares.<sup>845</sup> The first share of credits would come from the reduction in CO<sub>2</sub> emissions realized by the environment from a BEV that is not emitting from the tailpipe, represented by the first 1.0 portion of the multiplier.

Therefore, each BEV or FCEV produced receives base emission credits equivalent to the level of the standard, even before considering the effect of a multiplier. The second share of credits does not represent CO<sub>2</sub> emission reductions realized in the real world but rather, as just explained, was established by EPA to help incentivize a nascent market: in this example, the emission credits for BEVs built between MY 2021 and 2027 receive an advanced technology credit multiplier of 4.5, *i.e.*, an additional 3.5 multiple of the standard.

ii. Revisions to the Advanced Technology Credit Multipliers

We proposed to amend the existing Phase 2 rule to provide for an earlier phase out of multipliers for PHEVs and BEVs. In general, commenters’ support for the proposed approach for phasing out advanced technology credit multipliers varied (see section 10.3.1 of the RTC document for this rulemaking). Some commenters supported the proposal. Others commented that EPA should retain the multipliers through MY 2027 as finalized in the Phase 2 program, noting that manufacturers are relying on the availability of the multipliers for their compliance plans and so would need more lead time to revise their plans. Some commenters suggested that our statements in the proposal that there is sufficient incentive available for advanced technologies indicated that EPA should eliminate some or all multipliers before MY 2026. Others noted the need for continued support for manufacturers to develop these technologies, and recommended EPA extend the availability of some or all multipliers beyond MY 2027.

At proposal (88 FR 26010), we noted that revisions to credit multipliers should carefully balance several

<sup>843</sup> Letter from Michael Carter, CARB, to Gina McCarthy, Administrator, EPA and Mark Rosekind, Administrator, NHTSA, June 16, 2016. EPA Docket ID EPA–HQ–OAR–2014–0827\_attachment 2.

<sup>844</sup> 40 CFR 1037.150(f).

<sup>845</sup> See 40 CFR 1037.150(p) and 1037.705(b).



considerations. In terms of potential emissions impact, we acknowledged that a portion of the credits that result from an advanced technology multiplier do not represent CO<sub>2</sub> emission reductions realized in the real world and those excess credits could allow for backsliding of emission reductions expected from ICE vehicles. Relating to the need for continued incentives, we noted that increasing manufacturer production levels, the availability of IRA or BIL incentives, and targets set as part of California's ACT rule all indicate PHEV and BEV HD vehicles will be utilized increasingly in the near-term, reducing the need for the extra incentives provided by the advanced technology multipliers.

In the proposal, we also recognized, however, that some manufacturers' long-term product plans for PHEV or BEV technologies may have extended to model years closer to MY 2027, and we did not propose to immediately eliminate PHEV and BEV credit multipliers. 88 FR 26012. Instead, we proposed a MY 2026 phase-out for PHEV and BEV credit multipliers, one year earlier than adopted in Phase 2, in part, to limit the impact on current manufacturer product plans for the HD GHG Phase 2 standards and to provide some flexibility as manufacturers plan for the more stringent Phase 3 standards. We did not propose any changes to the advanced technology multiplier for fuel cell electric vehicles, which applies through MY 2027, noting that it was still appropriate to incentivize the development of fuel cell technology, because it has been slower to develop in the HD market, as discussed in section II (88 FR 26012). We note that the proposal regarding Phase 2's credit multipliers was limited to evaluating approaches to phase out their availability for use and we did not propose or request comment on extending credit multipliers to apply for other technologies.

In this final rule, commenters expanded on the proposed considerations. Some commenters noted that we are amending the definition of U.S. Directed Production Volume, as discussed in the section III.A.1, such that vehicle production volumes sold in California or section 177 states that adopt ACT would be included in the ABT credit calculations. These commenters indicated that continuing to allow multipliers for PHEVs and BEVs could expand banks of credits well past the point EPA contemplated when adopting the Phase 2 rule. Some of these commenters asserted that, given the Phase 2 flexibilities and the ACT requirements, manufacturers will

necessarily comply with the Phase 3 standards by virtue of complying with ACT. In contrast, several manufacturers commented that both their near-term Phase 2 and long-term compliance plans relied on the availability of credit multipliers (including use of credits generated from credit multipliers for Phase 2 compliance) and some even requested EPA extend the availability through MY 2030 to continue to incentivize the technologies. One manufacturer indicated that California's ACT program targets manufacturer sales, but that those sales only occur if customers purchase the products. This commenter noted that, while supporting regulations exist in some states, there are no nationwide initiatives to ensure sales, so it is unclear how many ZEVs will be sold as a result of ACT.

After considering the comments received on the proposal for this rule, we are not taking final action on the proposal to revise the Phase 2 rule to provide for an earlier phase out (one year early) of multipliers for PHEVs and BEVs. As such, manufacturers may continue to generate credits that include credit multipliers for PHEV, BEV, and FCEV technologies through MY 2027 as was adopted in Phase 2.<sup>846</sup> We note that our analysis of the feasibility of the Phase 3 standards did not rely on the availability of carried over credits from Phase 2 or Phase 2 credit multipliers; our assessment is that such credits will provide appropriate flexibilities for manufacturers in the transition into the early years of the Phase 3 program, as manufacturers make practical business decisions on where to apply their resources to first develop products. We also note that retaining the existing Phase 2 ABT provisions on credit multipliers should address potential concerns or uncertainties raised by manufacturers regarding their compliance plans relying on the credits generated under the existing Phase 2 credit multiplier provisions. However, as explained in the remainder of this preamble section, we are finalizing provisions to limit the potential use of credits generated from this flexibility.

We disagree with those commenters that assert manufacturers will necessarily comply with the Phase 3 standards by virtue of complying with ACT. These comments assume a given volume of Phase 2 credits will be generated and carried over into Phase 3, and thus presuppose manufacturers'

compliance strategies with both the Federal performance-based Phase 2 and 3 standards and the California ACT program. Our final rule reference case modeling is our best estimate of ZEV technology production volumes in the absence of the Phase 3 rulemaking, as supported by our analysis in preamble section V. Sales volumes could prove to be lower, however.<sup>847</sup> We also recognize that manufacturers may have different approaches and technology pathway plans to demonstrate compliance with Phase 2 as well as with ACT, as asserted by certain commenters and summarized previously in this section, and thus manufacturers may undertake different approaches than those asserted as the basis of commenters' concerns with multiplier credit volumes. EPA considered all of these comments in weighing potential limitations on ABT flexibilities for credits generated by the existing Phase 2 credit multipliers.

After balancing consideration of the concerns of disrupting on-going Phase 2 compliance strategies and the potential for multiplier credits to erode the emission benefits of the Phase 3 program, we are placing restrictions on how credits from multipliers can be used to meet the Phase 3 standards, and are additionally limiting their use to the initial model years of the Phase 3 program. As described in the remainder of this section III.A.2.ii, we are finalizing provisions that will limit when manufacturers can use credits generated from credit multipliers in MY 2027 through 2029 and eliminate the availability of those credits for use in MY 2030 and later.

As noted previously, advanced technology credits can be thought of as two portions: a base credit calculated using the equation in 40 CFR 1037.705(b) and a multiplier portion calculated using multipliers specified in 40 CFR 1037.150(p) for a given advanced technology. Our final provisions will continue to allow manufacturers to apply the base credits from advanced technologies through the 5-year credit life; however, to ensure meaningful vehicle GHG emission reductions under the Phase 3 program, we are finalizing restrictions for how manufacturers can use the multiplier portion of advanced technology credits toward Phase 3 compliance.

In MYs 2027 through 2029, manufacturers can continue to use multiplier credits to meet the Phase 3 standards; however, multiplier credits

<sup>846</sup> We are revising 40 CFR 1037.150(p) to clarify the applicable standards for calculating credits. We are finalizing parallel edits to existing 40 CFR 1037.615(a) and 1037.740(b) to clarify when the advanced technology credit calculations would apply.

<sup>847</sup> We also note that, in RIA Chapter 4.10, we conducted a reference case sensitivity analysis with lower ZEV adoption than we project will occur through compliance with CARB's ACT.

can only be applied toward Phase 3 compliance after available base credits are used. In a given model year within the timeframe this limitation applies, manufacturers quantify the credits available from advanced technologies, including from credits that were banked in previous years, and account for the base and multiplier portions of the credits. Then, for each family, they would calculate credits without consideration of credit multipliers (*i.e.*, credits and deficits from ICE vehicles, and base credits from vehicles with advanced technologies) and sum the credit quantities over all vehicle families in the averaging set.<sup>848</sup> If the credit quantity is positive, any surplus credits, including the multiplier credits, can be banked for future use. If the credit quantity for the given averaging set is negative, manufacturers must use available base credits before applying multiplier credits. Specifically, a manufacturer would apply credits in the following order of priority, while the credit quantity for the averaging set is negative:

1. Base credits banked or traded within the same averaging set.
2. Base credits earned in the same model year from other averaging sets (see section III.A.3 of this preamble).
3. Base credits banked or traded in other averaging sets and used across averaging sets as described in section III.A.3.
4. Multiplier credits within the same averaging set for the same model year.
5. Multiplier credits banked or traded within the same averaging set.
6. Multiplier credits earned in the same model year from other averaging sets.
7. Multiplier credits banked or traded in other averaging sets.

This limitation to using credits from multipliers for MYs 2027 through 2029 is intended to balance the competing concerns discussed in this section. Manufacturers would continue to have access to the full amount of credits from multipliers if needed in the early years of the Phase 3 program.<sup>849</sup> By prioritizing the use of base credits, we

<sup>848</sup> This first step is generally consistent with our historical approach to credits, which allows use of credits generated within the same model year but also first applies all such available credits through averaging to resolve credit balances for that model year before applying banked or traded credits. This approach prevents potential gaming of credit life and trading limitations. To further clarify this in the regulations, we are also adding an amendment in 40 CFR 1037.701(f) consistent with this description.

<sup>849</sup> See Brakora, Jessica. Memorandum to docket EPA-HQ-OAR-2022-0985. "Additional Considerations of ABT Provisions for HD GHG Phase 3 Final Rule". March 2024 for examples of how these provisions could apply.

are reducing the potential for multiplier credits to erode the emission benefits of the Phase 3 program, in particular in MYs beyond 2029.

We emphasize that this limitation to using credits from multipliers for MYs 2027 through 2029 is intended to apply for Phase 3 compliance. We want to preserve manufacturers' ability to implement their existing plans for complying with the Phase 2 program. Some manufacturers stated in their comments that they have included PHEV and BEV technologies in their plans to comply with Phase 2 standards and that those plans also rely on the credit multipliers for the remaining model years of the Phase 2 program. Others have indicated that credit multipliers are a critical incentive for FCEV development in the near term. To minimize the impact on manufacturers' Phase 2 compliance plans, we continue to allow full advanced technology credits, including any multiplier credits, to be used for Phase 2 compliance as currently allowed in the Phase 2 ABT program. That is, in MYs 2026 and earlier, averaged, banked, and traded Phase 2 advanced technology credits, including applicable multipliers, can be used to comply with the CO<sub>2</sub> standards in those years. In MY 2027, manufacturers will continue to have the option to earn advanced technology credits with multipliers relative to the Phase 3 standards. All multiplier credits can be used in full toward any Phase 2 deficits through MY 2029 (*i.e.*, the end of the 3-year window when manufacturers must remedy any MY 2026 Phase 2 deficits).

In MY 2030, we are phasing out the multiplier portion of any remaining advanced technology credits. Credits from Phase 2 advanced technologies will continue to be available, including those credits generated from their applicable multiplier, through MY 2029 as described previously in this section. In MY 2030 and later, manufacturers would retain any base credits previously earned from PHEV, BEV, or FCEV advanced technologies that are still within their credit life of 5 years, but manufacturers could no longer use multiplier credits for certifying model year 2030 and later vehicles. Any unused multiplier credits would expire in MY 2030.

Since some portion of the advanced technology credits have restricted or expiring use, we expect to track base credits separate from multiplier credits in evaluating compliance and will work with manufacturers to prioritize which credits are applied for a given model year consistent with the final restrictions and provisions. Finally, we

note that in section II.B of this preamble we describe part of EPA's commitment to monitor the on-going implementation of the HD vehicle GHG programs as assessing manufacturers' use of the CO<sub>2</sub> emissions ABT program. This will include evaluating manufacturers' use of advanced technology multipliers, quantifying any banked credits generated from the use of multipliers, and considering the potential for those credits to undermine the overall goals of the Phase 3 program in the MY 2027 and later time frame. If we identify a significant volume of banked credits from credit multipliers that we determine is undermining the goals of the Phase 3 program, we may consider further restrictions in a future action.

### 3. Transitional Flexibility Allowing Credit Exchange Across Averaging Sets

In recognition that the final HD GHG Phase 3 standards will require meaningful investments from manufacturers to reduce GHG emissions from HD vehicles, we are finalizing additional flexibilities to assist manufacturers in the implementation of Phase 3. Specifically, we requested comment on and are finalizing an interim (*i.e.*, temporary) flexibility for manufacturers to use certain credits across averaging sets, with limitations outlined in this section. We are retaining our current averaging set definitions and our approach that limits averaging, banking, or trading within an averaging set for credits or deficits generated from heavy-duty vehicles outside the range of model years over which this transitional allowance applies.<sup>850</sup>

In HD GHG Phase 1, we adopted an approach to allow advanced technology credits to earn a multiplier of 1.5 and be applied to any heavy-duty engine or vehicle averaging set, subject to a cap.<sup>851</sup> In HD GHG Phase 2, we discontinued the allowance to reduce the risk of market distortions if we allowed the use of the credits across averaging sets combined with the larger credit multipliers.<sup>852</sup> As discussed in section III.A.2, manufacturers will continue to have the flexibility to generate advanced technology credit multipliers through model year 2027 but those credits generated from multipliers would only be available for use through model year 2029.

We requested comment on the flexibility for credits generated from PHEV, BEV, and FCEV to be used across certain averaging sets, including for HD

<sup>850</sup> 40 CFR 1037.140(g) and 1037.740(a).

<sup>851</sup> 40 CFR 1036.740(c) and 1037.740(b).

<sup>852</sup> 81 FR 73498, October 25, 2016.

vehicles subject to 40 CFR part 1037, HD engines subject to 40 CFR part 1036, or heavy-duty vehicles subject to 40 CFR part 86, subpart S, and any limitations we should consider. 88 FR 26013. In comments, many vehicle manufacturers expressed concern over the level of the proposed standards and, for those considering a compliance pathway similar to the potential pathway EPA modeled, the uncertainties in their ability to produce enough BEV or FCEV or otherwise to meet the standards. Commenters expressing support for using credits across averaging sets generally noted that the flexibility would help manufacturers implement advanced technologies in the vehicle segments with the greatest demand or cost effectiveness. Some of these supportive commenters suggested EPA expand the flexibility beyond the examples provided in the requests for comment. Commenters opposed to allowing credit transfers across averaging sets generally expressed concern over market distortions and reduced effectiveness of the rule.

After considering comments and further evaluation of the example flexibilities included as requests for comment in the proposal, the final provision, available as an interim, transitional flexibility during model years 2027 through 2032, will allow manufacturers some flexibility to use credits generated from heavy-duty vehicles across averaging sets. In this section III.A.3, we describe how the allowance applies for heavy-duty vehicles under 40 CFR part 1037 and heavy-duty vehicles under 40 CFR part 86, subpart S. We also explain our decision not to extend this flexibility to allow heavy-duty vehicle credits for use in the heavy-duty engine averaging sets under 40 CFR part 1036. See also section 10.3.2 of the response to comments document for this rule.

**i. Applicability of the Transitional Flexibility Allowing Credit Exchange Across Averaging Sets**

The current rules provide three averaging sets for HD vehicles: Light HDV, Medium HDV, and Heavy HDV (see 40 CFR 1037.740(a)). Credits generated by vehicles may only be averaged, banked, or traded within each averaging set. *Id.* EPA sought comment on revising this limitation during the initial phase-in years of the Phase 3 program for credits generated from Phase 2's designated advanced technologies. 88 FR 26013. EPA's request for comment also included the possibility of credits generated by chassis-certified Class 2b/3 vehicles

certified under 40 CFR part 86, subpart S, being allowed to be used within the HD vehicle ABT program and credits from HD vehicles being allowed to be used within the HD engine ABT program. *Id.*

The provision that limits credit exchanges to within averaging sets is unique to the heavy-duty rules—on the light-duty vehicle side, credits can flow freely among all vehicle types. EPA implemented the limitation because heavy-duty vehicles comprise so many applications that calculations across averaging sets of, for example, operating life and load cycles could prove problematic. 76 FR 57240 (September 11, 2011). EPA has also noted manufacturer equity concerns (see, e.g., 55 FR 30586 (July 26, 1990)), whereby manufacturers with broader product lines might have an unfair advantage because of greater opportunities to average. EPA further indicated, however, that we could reassess these limitations after gaining experience administering the program. 76 FR 57240. In this rulemaking, commenters did not voice these concerns, and HD manufacturers commented that averaging across the HDV averaging sets would no longer afford competitors an unfair advantage.<sup>853</sup>

After considering comments, we are finalizing an interim provision allowing credits to be used across HD vehicle averaging sets during the MY 2027 through MY 2032 period. More specifically, during model years 2027 through 2032, manufacturers can transfer credits generated from heavy-duty vehicles in MYs 2027–2032 between all heavy-duty vehicle averaging sets in 40 CFR part 1037. Thus, credits can transfer from Light HDV to Medium HDV or Heavy HDV, from Medium HDV to Light HDV or Heavy HDV, and from Heavy HDV to Light HDV or Medium HDV. We note that we are finalizing this interim provision to include credits generated by all heavy-duty vehicles, including those using ICE-based vehicle technologies and not limited to Phase 2 advanced technologies. The broad applicability of this interim provision ensures that we continue to incentivize future vehicle technology that may generate credits against the Phase 3 standards by including it within this interim flexibility.

We also requested comment on the possibility of allowing manufacturers certifying under 40 CFR part 1037 to access credits generated by Class 2b and

3 pickup trucks and vans<sup>854</sup> (see 88 FR 26013). One manufacturer of medium-duty vehicles commented in support of that potential allowance, indicating that there is a two-year delay in adapting light-duty vehicle technology for the heavy-duty vehicle market. No other affected manufacturers commented on the issue. After considering comments, we are finalizing provisions allowing manufacturers to access credits generated by model year 2027 through 2032 medium-duty vehicles to certify heavy-duty vehicles, with some limitations as described in the following section III.A.3.ii. Specifically, we are finalizing an interim allowance for one-way credit transfers from averaging sets for medium-duty vehicles certified to 40 CFR part 86, subpart S, to averaging sets for heavy-duty vehicles certified to 40 CFR part 1037.<sup>855</sup>

As previously explained, Phase 2 credits may be banked for use in the Phase 3 program and manufacturers can continue to apply all available Phase 2 credits within the applicable averaging sets consistent with the existing ABT program. In section III.A.3.ii, we describe some limitations on the use of banked credits under this transitional flexibility.

We have calculated the range of credits that would be eligible for transfer across averaging sets and estimated the relative impact of these newly available credits, and project that use of this flexibility will have a limited impact on the stringency of the Phase 3 standards.<sup>856</sup> While we anticipate no significant negative emissions impact, we are finalizing the transitional flexibility as an interim provision, available until model year 2032, because we do not expect a continued need for such a flexibility once the Phase 3 program is fully implemented. We may consider extending the flexibility in a future rule.

**ii. Limitations of the Transitional Flexibility Allowing Credit Exchange Across Averaging Sets**

As noted in section III.A.2, we have taken steps to reduce the potential for

<sup>854</sup> The recent Light- and Medium-duty final rule now classifies these vehicles as "Medium Duty Vehicles". See Final Rule: Multi-Pollutant Emissions Standards for Model Years 2027 and Later Light-Duty and Medium-Duty Vehicles. Docket number EPA-HQ-OAR-2022-0829. Available online: <https://www.epa.gov/regulations-emissions-vehicles-and-engines/final-rule-multi-pollutant-emissions-standards-model>.

<sup>855</sup> See 40 CFR 86.1819–14 and 40 CFR 1037.150(z).

<sup>856</sup> See Brakora, Jessica. Memorandum to docket EPA-HQ-OAR-2022-0985. "Additional Considerations of ABT Provisions for HD GHG Phase 3 Final Rule". March 2024 for illustrations of how these provisions could operate in tandem.

<sup>853</sup> See, for example, comments from Volvo Group (EPA-HQ-OAR-2022-0985–1606, p 20–21).

Phase 2 advance technology multiplier credits to dilute the effective stringency of the Phase 3 standards by restricting the use of credits generated from multipliers to MYs 2027 through 2029 and phasing out their availability in MY 2030. These multiplier credit restrictions also limit potential impacts from allowing credits to exchange across averaging sets as the restrictions apply within the range of model years over which this transitional flexibility applies. In this section III.A.3.ii, we describe other specific limitations we are adopting for heavy-duty vehicles under 40 CFR part 1037 and heavy-duty vehicles under 40 CFR part 86, subpart S, to further reduce potential impacts of credit exchanges across the applicable averaging sets.

As noted previously, manufacturers may bank credits generated before MY 2027 for use in Phase 3. However, for this transitional flexibility allowing credits to exchange across averaging sets, a manufacturer may only use credits from MY 2026 and earlier vehicles if the credits were generated from vehicles certified as advanced technologies under 40 CFR part 1037.<sup>857</sup> We are extending the interim cross-averaging set flexibility to include these credits given that increased utilization of advanced technologies prior to the commencement of the Phase 3 program has the potential to lead to very large reductions in GHG emissions (as we recognized in the Phase 2 rulemaking).

The final rule includes several limitations on the flexibility to use credits to demonstrate compliance with Phase 3 standards. First, we are not extending the interim flexibility to include credits generated from MY 2026 and earlier vehicles certified to 40 CFR part 86, subpart S. Those earlier vehicles are subject to less stringent standards, which also include the allowance to generate multiplier credits for advanced technologies. Allowing heavy-duty vehicle manufacturers to access credits from these earlier medium-duty vehicles would risk substantially delaying the benefits of the Phase 3 standards. Second, we are limiting the use of credits from 40 CFR part 86, subpart S, to a one-way transfer to 40 CFR part 1037 in recognition that there is greater availability of advanced technologies in pickup trucks and vans and less need to offer a flexibility for vehicles in that market relative to the larger vehicle classes. Third, medium-duty credits may be used for demonstrating compliance only for

Light HDV or Medium HDV averaging sets; this is consistent with the request for comment in the proposed rule.

Regarding credits from vehicles certified to 40 CFR part 86, subpart S, we make two additional clarifications. First, any credits transferred under this flexibility would no longer be available for the part 86 ABT program to aid in manufacturers meeting the requirements for medium-duty vehicles. Second, vehicles defined as Medium-duty Passenger Vehicles in 40 CFR part 86, subpart S, are over 8,500 pounds GVWR but are subject to the standards that apply for light trucks and are therefore not eligible to generate credits for this transitional flexibility.

Some commenters expressed concern with the Phase 2 ABT provisions allowing credits from vocational vehicles to be used for tractors in the same weight class. They argued that a manufacturer may use vocational vehicle ZEV credits to offset tractors, thereby limiting adoption of ZEV technology in tractors. Were manufacturers to do so, this would be consistent with the original intent of the ABT program, which is to provide manufacturers the flexibility to identify which vehicle categories to apply new technologies for their specific product line to meet the standards, generally allowing them to meet standards at lower cost. As we describe later in this response, we project a limited impact on emissions from this new (and temporary) flexibility.

We also requested comment on the possibility of allowing a one-way transfer of CO<sub>2</sub> credits from heavy-duty vehicle averaging sets to heavy-duty engine averaging sets (see 88 FR 26013 seeking comment on this potential flexibility). While some commenters expressed general support for this allowance, we expect we would need to apply restrictions on the engine averaging sets where vehicle credits can be applied to limit potential disproportionate adverse emission impact on certain engine categories and FEL caps to avoid backsliding on the engine standards. At this time, we are not finalizing such a flexibility as we believe the complexity would limit the use of this flexibility relative to the other flexibilities we are finalizing in this rule.

Finally, we requested comment on capping the volume of credits that can be transferred across the HD vehicle averaging sets. 88 FR 26013. We are not including a cap on credits transferred between averaging sets in the final interim flexibility. A cap would be justified in cases where vehicles with zero or near-zero tailpipe CO<sub>2</sub> emissions

are able to offset a significant number of vehicles in any given averaging set under this flexibility. Our assessment of the effect of those vehicles does not indicate a such an offset. Furthermore, we do not want manufacturers to limit production of technologies with the potential for very large GHG emission reductions in order to be within a cap; in particular we do not want to disincentivize manufacturers from producing additional vehicles with technologies that can achieve very large GHG emissions reductions.

*B. Battery Durability Monitoring and Warranty Requirements*

This section describes the battery durability monitoring requirements that we are finalizing for BEVs and PHEVs and how warranty applies for several advanced technologies. As we explained in the proposal, BEVs, PHEVs, and FCEVs are playing an increasing role in vehicle manufacturers' compliance strategies to control GHG emissions from HD vehicles. The battery durability and warranty requirements support BEV, PHEV, and FCEV battery durability and thus support achieving the GHG emissions reductions projected by this program. Further, these requirements support the integrity of the GHG emissions credit calculations under the ABT program as these calculations are based on mileage over a vehicle's full useful life.<sup>858</sup>

At the outset we note that, in comments, the Engine Manufacturers Association (EMA) challenged EPA's authority to adopt durability and warranty requirements for these powertrains and their components. Before describing the final rule provisions relating to durability and warranty, we first address this threshold issue. EMA agrees that EPA has authority "to set lower emission standards as advancements in technology allow, even down to zero," but maintains that authority to establish useful life, durability, and warranty requirements related to such standards differs because these provisions are applicable only to "emission related" components, and BEV and FCEV powertrain components do not emit: "EPA's authority to prescribe useful life requirements under CAA section 202(d) is directly tied to the purpose of extending the time span of emission standards that limit the rate, quantity or concentration of emissions of air pollutants from new motor vehicles . . . . Since ZEV powertrains, including ZEV batteries, do not and cannot emit

<sup>857</sup> This allowance includes any credits generated from multipliers under 40 CFR part 1037 that are available for use in MYs 2027–2029.

<sup>858</sup> These two rationales are separate and independent justifications for the requirements.

any air pollutants in any quantity into the ambient air . . . , EPA does not have the authority to set emissions-related useful life requirements for BEV and FCEV powertrains or their various non-emitting components.” With regard to warranty and durability, EMA further states that “CAA section 207(a)(1) makes it clear that the scope of authorized warranties is to ensure that vehicles and engines ‘are designed, built and equipped so as to conform at the time of sale with the applicable regulations [*i.e.*, emission standards] established under section . . . [section 202(a)(1)].”<sup>859</sup>

EPA’s authority to set and enforce durability requirements for emission-related components like batteries is an integral part of its title II authority. Durability requirements ensure that vehicle manufacturers and the vehicles they produce will continue to comply with emissions standards set under 202(a) over the course of those vehicles’ useful lives. Such authority arises both out of section 202(a)(1) and 202(d) (relating to a vehicle’s useful life) and section 206(a)(1) and 206(b)(1) (relating to certification requirements for compliance).

EPA accounts for durability at certification by requiring, as part of the compliance demonstration for meeting GHG emission standards, a demonstration that emission controls will not deteriorate during useful life, such as for a battery in a hybrid or plug-in hybrid electric vehicle. 40 CFR 1036.241(c) and 1037.241(c). Durability of a ZEV battery is covered by this same provision and principle. EPA has exercised its authority to set emission durability requirements across a variety of emission-related components for decades, including electrified technology like electronic control modules (ECM). See, *e.g.*, 40 CFR 1065.915(d) (permitting ECM signals in place of Portable Emissions Measurement System (PEMS) instrument measurements); 40 CFR 1037.605 (requiring ECM programming where vehicle is speed limited to 45 mph as part of alternate standards certification).

EPA has separate authority to set warranty requirements for batteries in ZEVs and PHEVs. CAA section 207(a)(1). Providing a warranty for emission-related components like batteries precisely accomplishes the congressional purpose of assuring purchasers that vehicles will conform to applicable emission standards at time of

sale and in use. Previously, EPA has already set warranty requirements for batteries in hybrids and PHEVs. See 88 FR 4363 (discussing 40 CFR 1036.120). EPA has also previously provided warranties for other electrified technologies, such as ECMs. Indeed, Congress explicitly provided that ECMs are “specified major emissions control component[s]” for warranty purposes per section 207(i)(2).

In general, ZEV batteries, just like batteries in PHEVs and other hybrid vehicles, are emission-related components for two reasons, thus providing EPA authority to set durability and warranty requirements applicable to them. First, they are emission-related by their nature. Durability and warranty requirements for batteries are not like requiring durability and warranty for a vehicle component like a vehicle’s “windshield” or “brake pedals” that have no relevance to a vehicle’s emissions. Integrity of a battery in a vehicle with these powertrains is vital to the vehicle’s emission performance; integrity of its “brake pedals” is not. It is wrong to say that a component that allows a vehicle to operate entirely without emissions is not emission-related. See 40 CFR 1037.120(c) (“The emission-related warranty also covers other added emission-related components to the extent they are included in your application for certification, and any other components whose failure would increase a vehicle’s CO<sub>2</sub> emissions.”).<sup>860</sup>

Second, for warranty and durability purposes, EPA has consistently considered a component to be “emission related” if it relates to a manufacturer’s ability to comply with emissions standards, regardless of the form of those standards.<sup>861</sup> For standards to be meaningfully applicable across a vehicle’s useful life, EPA’s assessment of compliance with such standards necessarily includes an evaluation of the performance of the emissions control systems, which for BEVs, FCEVs, and PHEVs includes the battery system both when the vehicle is new and across its useful life. This is particularly true given the averaging form of standards that EPA uses for GHG emissions (and which EMA

continues to support) and which most manufacturers choose for demonstrating compliance. Given the fleet average nature of the standards, the Agency needs to have confidence that the emissions reductions—and thus credits generated—by each BEV, FCEV, and PHEV introduced into the fleet are reflective of the real world. This is particularly important because one of the elements of the credit generating formula is useful life of the vehicle in miles travelled, see 40 CFR 1037.705(a).

Ensuring that ZEVs and PHEVs contain durable batteries is thus essential to assuring the integrity of the averaging process: assuring that vehicles will need to perform in fact for the useful life mileage reflected in any credits they may generate. Put another way, durable batteries are a significant factor in vindicating the averaging form of the standard: that the standard is met per vehicle, and on average per fleet, throughout the vehicles’ useful life. The battery durability and warranty provisions finalized in this rulemaking allow for greater confidence that the batteries installed by vehicle manufacturers are durable and thus support the standards. Specifically, the durability regulatory provisions for batteries work to assure the integrity of the standards throughout a vehicle’s useful life, precisely in accord with the requirements of section 202(a)(1) and 202(d), and batteries are clearly emissions-related components for which warranty requirements may be set under 207(a)(1). EPA therefore disagrees with EMA that it lacks authority to adopt such standards. EMA’s assertion that these provisions are unrelated to the emission standards is consequently completely misplaced.

In addition to EPA’s general authority to promulgate durability requirements under sections 202 and 206, EPA has additional separate and specific authority to require on-board monitoring systems capable of “accurately identifying for the vehicle’s useful life as established under [section 202], emission-related systems deterioration or malfunction.” Section 202(m)(1)(A).<sup>862</sup> As we discuss at length in this section, EV batteries are “emission-related systems,” and thus EPA has the authority to set durability monitoring requirements for such

<sup>860</sup> The listed components in 40 CFR 1037.120(c)—“tires, automatic tire inflation systems, tire pressure monitoring systems, vehicle speed limiters, idle reduction systems, devices added to improve aerodynamic performance (not including standard components such as hoods or mirrors), fuel cell stacks, and RESS with hybrid systems, battery electric vehicles, and fuel cell electric vehicles “—are evidently all related to vehicular emissions.

<sup>861</sup> See 88 FR 4296, January 24, 2023.

<sup>862</sup> Section 202(m)(1)(A) specifically applies to light duty vehicles and light duty trucks, but section 202(m)(1) allows EPA to “promulgate regulations requiring manufacturers to install such onboard diagnostic systems on heavy-duty vehicles and engines,” which provides concurrent authority for the battery monitoring requirements discussed in this section.

<sup>859</sup> The comment did not address durability requirements related to PHEV components (see RTC section 11.1).

systems over the course of a vehicle's useful life.

EMA suggests that EPA does not have authority to set durability or warranty requirements because ZEV batteries are not emission-related for several reasons. First, EMA argues that because ZEVs do not themselves emit, they and their powertrain components are "not within the scope of any specific emission standards," and therefore they cannot be subject to "emissions-related" durability and warranty requirements. But EPA does have the authority to set standards for ZEVs as they are part of the "class" of regulated vehicles. In addition, all vehicles, including ZEVs, are subject to an applicable Family Emission Limit (FEL) throughout their useful life to demonstrate compliance with EPA's GHG emissions standards.<sup>863</sup>

EMA argues secondly that a component only counts as emission-related if its failure would allow the vehicle to continue operating, but with higher emissions. But nothing in the statute imposes such a limitation. Moreover, while it is true that the failure of a battery would cause the vehicle to stop operating, the same is true for some other vehicle components that have also historically been subject to durability requirements. For instance, EPA has set durability requirements for diesel engines (see 40 CFR 86.1823-08(c)), failure of which could cause the vehicle to stop operating. Similarly, Congress explicitly provided that electronic control modules (ECMs) (described in the statute as "electronic emissions control units") are "specified major emissions control component[s]" for warranty purposes per section 207(i)(2); failure of ECMs can also cause the vehicle to stop operating, and not necessarily increase the emissions of the vehicle.

EMA is also mistaken in suggesting that there is no way to warrant at time of sale that a vehicle that lacks tailpipe emissions is "designed, built, and equipped so as to conform, at time of sale with applicable regulations under [section 202(a)(1). . . and . . . for its useful life, as determined by [section 202(d)]." Section 207(a)(1). In fact, automakers warrant at the time of sale that each new vehicle is designed to

<sup>863</sup> See preamble section I.C and Response to Comments section 10.2.1 for further description of EPA's authority to set standards under section 202(a) using an averaging form, and to include ZEVs and PHEVs within a fleet average-based standard. For a more detailed description of the ABT process for HDVs, see section III.A of this preamble and section 10.2.1.d of the RTC document. EPA replies to the commenter's assertions regarding authority to establish standards for a vehicle's useful life as part of that same response to comments.

comply with all applicable emission standards and will be free from defects that may cause noncompliance. They do so with respect to all emission-related components in the manufacturer's application for certification, as noted, and which explicitly include batteries (also known as Rechargeable Energy Storage System (RESS)). See 40 CFR 1037.120(c). These provisions are readily implementable at time of sale and thereafter by reference to the applicable certified FEL and comport entirely with section 207 of the Act.

We intend for the battery durability and warranty requirements finalized in this rule to be entirely separate and severable from the revised emissions standards and other varied components of this rule, and also severable from each other. EPA has considered and adopted battery durability requirements, battery warranty requirements, and the remaining portions of the final rule independently, and each is severable should there be judicial review. If a court were to invalidate any one of these elements of the final rule, we intend the remainder of this action to remain effective, as we have designed the program to function even if one part of the rule is set aside. For example, if a reviewing court were to invalidate the battery durability requirements, we intend the other components of the rule, including the GHG standards, to remain effective.

As we explain previously in this section, for manufacturers who choose to produce BEVs, FCEVs, or PHEVs, durable batteries are important to ensuring that the manufacturer's overall compliance with fleet emissions standards would continue throughout the useful life of the vehicle. The battery durability and warranty provisions EPA is finalizing help assure this outcome. At the same time, we expect that, even if not strictly required, the majority of vehicle manufacturers would still produce vehicles containing durable batteries given their effect on vehicle performance and the competitive nature of the industry. Available data indicates that manufacturers are already providing warranty coverage similar to what is required by the final durability and warranty requirements for ZEVs and PHEVs of various sizes.<sup>864 865 866 867 868</sup> Given the

<sup>864</sup> United Nations Economic Commission for Europe Informal Working Group on Electric Vehicles and the Environment (UN ECE EVE), "Battery Durability: Review of EVE 34 discussion," May 19, 2020, p. 12. Available at <https://wiki.unece.org/download/attachments/101555222/EVE-35-03e.pdf?api=v2>.

<sup>865</sup> UK Department of Transport, "Commercial electric vehicle battery warranty analysis," April

competitive nature of the ZEV and PHEV market, we anticipate that manufacturers will continue to do so, regardless of EPA's final rule.

Moreover generally, the battery durability and warranty requirements resemble many other compliance provisions that facilitate manufacturers' ability to comply with the standards, as well as EPA's ability to assure and enforce that compliance. Were a reviewing court to invalidate any compliance provision, that would preclude the agency from applying that particular provision to assure compliance, but it would not mean that the entire regulatory framework should fall with it. Specifically, were a reviewing court to invalidate the final durability and warranty requirements, EPA would continue to have numerous tools at its disposal to assure and enforce compliance of the final standards, including the entire panoply of certification requirements, in-use testing requirements, administrative and judicial enforcement, and so forth, so as to achieve significant emissions reductions. Therefore, EPA is adopting and is capable of implementing final standards entirely separate from the battery durability and warranty requirements. The contrapositive is also true: EPA is adopting and capable of implementing the battery durability and warranty requirements entirely separate from the standards. For example, even without the final standards, we believe the enhanced battery durability and warranty requirements would serve to facilitate compliance with the existing GHG standards.

#### 1. BEV and PHEV Durability Monitoring Requirements

EPA's HD vehicle GHG emission standards apply for the regulatory useful life of the HD vehicle, consistent with CAA section 202(a)(1) ("Such standards shall be applicable to such vehicles and engines for their useful life"). Section

25, 2023. Available at <https://wiki.unece.org/download/attachments/192840855/EVE-61-08e%20-%20UK%20warranty%20analysis.pdf?api=v2>.

<sup>866</sup> CarEdge.com, "The Best Electric Vehicle Battery Warranties in 2024," January 9, 2024. Accessed on February 16, 2024 at <https://caredge.com/guides/ev-battery-warranties>.

<sup>867</sup> California Air Resources Board, "Cars and Light-Trucks are Going Zero—Frequently Asked Questions." Accessed on February 16, 2024 at <https://ww2.arb.ca.gov/resources/documents/cars-and-light-trucks-are-going-zero-frequently-asked-questions>.

<sup>868</sup> Forbes, "By The Numbers: Comparing Electric Car Warranties," October 31, 2022. Accessed on February 16, 2024 at <https://www.forbes.com/sites/jimgorzelay/2022/10/31/by-the-numbers-comparing-electric-car-warranties/?sh=2ed7a5243fd7>.

202(d) commands EPA to prescribe regulations establishing useful life for purposes of section 202(a)(1) standards. Accordingly, EPA has historically required manufacturers to demonstrate the durability of their emission control systems on vehicles, implementing these authorities as well as EPA's authority to prescribe "appropriate testing" for purposes of vehicle certification under section 206(a). See, e.g., 40 CFR 1037.205(l) (requiring applicants for certification to identify the vehicle family's deterioration factors and how the manufacturer derived those factors) and 1037.241(b)<sup>869</sup> (EPA may require engineering analysis showing that performance of emission controls will not deteriorate in use as part of certification process). Without durability demonstration requirements, EPA would not be able to assess whether vehicles originally manufactured in compliance with relevant emissions standards (including the subfamily specific Family Emission Limit (FEL) to which each vehicle is certified, for manufacturers complying using the ABT compliance alternative; see section III.A of this preamble and RTC chapter 10.2.1, section d) would remain compliant over the course of their useful life. Recognizing that BEV, PHEV, and FCEV are playing an increasing role in manufacturers' compliance strategies, and that emission credit calculations are based in part on mileage over a vehicle's useful life, the same logic applies to BEV, PHEV, and FCEV battery and powertrain durability. Under 40 CFR part 1037, subpart H, credits are calculated by determining the FEL each vehicle subfamily achieves beyond the standard and multiplying that by the production volume and a useful life mileage attributed to each vehicle subfamily.<sup>870</sup> Having a useful life mileage value for each vehicle subfamily is integral to calculating the credits attributable to that vehicle, whether those credits are used for calculating compliance through averaging, or for banking or trading.

Because vehicle manufacturers can use such emissions control technologies

<sup>869</sup> In this final action we are moving 40 CFR 1037.241(c) to 40 CFR 1037.241(b).

<sup>870</sup> More specifically, vehicle families and subfamilies are certified to the applicable standard and FEL. Conditions are placed on the certificates to ensure compliance with the fleet average after the year's production is completed. The production-weighted sum of the families and their FELs within each averaging set must be equal to or less than the applicable emission standard. The useful life values for the HD vehicle standards are located in 40 CFR 1037.105(e) and 1037.106(e). 40 CFR 1037.705(b) specifies that useful life of the vehicle, in miles, is part of the formula used to determine credit generation.

to comply with EPA standards, we proposed and are finalizing requirements to ensure that such vehicles certifying to EPA standards are durable and capable of providing the anticipated emissions reductions to which they are certified. Specifically, we are finalizing a requirement that manufacturers provide a customer-facing battery state-of-health (SOH) monitor for all heavy-duty BEVs and PHEVs. The new 40 CFR 1037.115(f) requires manufacturers to install a customer-accessible SOH monitor which estimates, monitors, and communicates the vehicle's state of certified energy (SOCE) as it is defined in 40 CFR 1037.115(f). Specifically, manufacturers would implement onboard algorithms to estimate the current state of health of the battery, in terms of the state of its usable battery energy (UBE) expressed as a percentage of the original UBE when the vehicle was new.

EPA may perform in-use testing "of any vehicle subject to the standards." 40 CFR 1037.401(a). This in-use testing is compared to the FEL to which the vehicle is certified. See 40 CFR 1037.241(a)(2) ("Note that the FEL is considered to be the applicable emissions standard for an individual configuration"). If manufacturers are complying with the standard by averaging credits, emission credits would be calculated assuming the battery sufficiently maintains its performance for the full useful life of the vehicle. Without battery-specific durability requirements applicable to such vehicles, we are mindful that there would not be a guarantee that a manufacturer's overall compliance with emission standards would continue throughout that useful life. We are finalizing new battery durability monitoring to apply for MY 2030 and later HD BEVs and PHEVs as a key step in assuring the emission reductions projected for this program will be achieved in use.

As implemented by light-duty vehicle manufacturers in current BEVs and PHEVs, lithium-ion battery technology has been shown to be effective and durable for use and we expect that this will also be the case for heavy-duty vehicles.<sup>871</sup> We recognize that the energy capacity of a battery will naturally degrade to some degree with time and usage, which can result in a reduction in driving range as the vehicle ages. See RIA Chapter 2.4.1.1.3. Excessive battery degradation in a PHEV could lead to higher fuel consumption

<sup>871</sup> See RIA Chapter 2.4.1.1.4, for how we accounted for battery deterioration in our analysis.

and increased criteria pollutant tailpipe emissions, while a degraded battery in a BEV could impact its ability to deliver the lifetime mileage expected. This effectively becomes an issue of durability if it reduces the utility of the vehicle or its useful life, and EPA will closely track developments in this area and propose modifications as they become necessary.

Vehicle and engine manufacturers are currently required to account for potential battery degradation that could result in an increase in CO<sub>2</sub> and criteria pollutant emissions when certifying hybrid or plug-in hybrid vehicles (see, e.g., existing 40 CFR 1037.241(b) and 1036.241(c)).<sup>872</sup> In addition, engine manufacturers are required to demonstrate compliance with criteria pollutant standards using fully aged emission control components that represent expected degradation during useful life (see, e.g., 40 CFR 1036.235(a)(2) and 1036.240). We considered these well-established approaches, as well as comments received, for the final battery durability monitoring requirements for HD BEVs and PHEVs.

The importance of battery durability in the context of zero- and near-zero emission vehicles, such as BEVs and PHEVs, has been cited by several authorities in recent years. In their 2021 Phase 3 report,<sup>873</sup> the National Academies of Science (NAS) identified battery durability as an important issue with the rise of electrification.<sup>874</sup> Several rulemaking bodies have also recognized the importance of battery durability in a world with rapidly increasing numbers of zero-emission vehicles. In 2015 the United Nations Economic Commission for Europe (UNECE) began studying the need for a Global Technical Regulation (GTR) governing battery durability. In April 2022 it published United Nations Global Technical Regulation No. 22, "In-

<sup>872</sup> We are removing current 40 CFR 1037.241(b) and redesignating 40 CFR 1037.241(c) to 40 CFR 1037.241(b).

<sup>873</sup> National Academies of Sciences, Engineering, and Medicine 2021. "Assessment of Technologies for Improving Light-Duty Vehicle Fuel Economy 2025–2035". Washington, DC: The National Academies Press. <https://doi.org/10.17226/26092>.

<sup>874</sup> Among the findings outlined in that report, NAS noted that: "battery capacity degradation is considered a barrier for market penetration of BEVs," (p. 5–114), and that "[knowledge of] real-world battery lifetime could have implications on R&D priorities, warranty provision, consumer confidence and acceptance, and role of electrification in fuel economy policy." (p. 5–115). NAS also noted that "life prediction guides battery sizing, warranty, and resale value [and repurposing and recycling]" (p. 5–115), and discussed at length the complexities of SOH estimation, life-cycle prediction, and testing for battery degradation (p. 5–113 to 5–115).

Vehicle Battery Durability for Electrified Vehicles,”<sup>875</sup> or GTR No. 22, which provides a regulatory structure for contracting parties to set standards for battery durability in BEVs and PHEVs.<sup>876</sup> The European Commission and other contracting parties have also recognized the importance of durability provisions and are working to adopt the GTR standards in their local regulatory structures.

EPA concurs with the emerging consensus that battery durability is an important issue. The ability of a zero-emission vehicle to achieve the expected emission reductions during its lifetime depends in part on the ability of the battery to maintain sufficient driving range, capacity, power, and general operability for a period of use comparable to that expected of a conventional vehicle. Durable and reliable electrified vehicles are therefore critical to ensuring that projected emissions reductions are achieved by this program. The durability monitoring regulations will require manufacturers of BEVs and PHEVs to develop and implement an on-board state-of-certified-energy (SOCE) monitor that can be read by the vehicle user. These requirements are similar to the battery durability monitor regulation framework developed by the UN ECE and adopted in 2022 as GTR No. 22. We did not propose and are not finalizing durability monitoring requirements for FCEV manufacturers at this time because the technology is currently still emerging in heavy-duty vehicle applications, and we are still learning what the appropriate metric might be for quantifying FCEV performance.

The Administrator has determined that GTR No. 22, which was developed with extensive input from EPA, provides an appropriate framework and set of requirements for ensuring battery durability and should be integrated into the context of this rulemaking for this purpose. The requirements and general framework of the battery durability program under this rule are therefore largely identical to those outlined in GTR No. 22 and broadly parallel the GTR in terms of the hardware, monitoring and compliance

<sup>875</sup> United Nations Economic Commission for Europe, Addendum 22: United Nations Global Technical Regulation No. 22, United Nations Global Technical Regulation on In-vehicle Battery Durability for Electrified Vehicles, April 14, 2022. Available at: [https://unece.org/sites/default/files/2022-04/ECE\\_TRANS\\_180a22e.pdf](https://unece.org/sites/default/files/2022-04/ECE_TRANS_180a22e.pdf).

<sup>876</sup> EPA representatives chaired the informal working group that developed this GTR and worked closely with global regulatory agencies and industry partners to complete its development in a form that could be adopted in various regions of the world, including potentially the United States.

requirements, the associated statistical methods and metrics that apply to determination of compliance, and criteria for establishing battery durability and monitor families.

For BEV, we requested comment as to the desirability of EPA defining a standard procedure for determining UBE. 88 FR 26015. We received comments both supporting and objecting to EPA defining such a standard test procedure. We are not finalizing a specific procedure at this time due to the range of HD BEV architectures and the limited test facilities for conducting powertrain testing of BEV with e-axes. In addition, we are not requiring pack level testing for the determination of UBE, as allowing for vehicle level testing would enable easier verification of UBE with in-use vehicles. The final rule instead requires manufacturers to develop and get EPA approval of their own test procedure for determining UBE that meets the criteria that is described in this section. With the SOCE being a relative measure of battery health and not absolute UBE, we believe that leaving the test procedure up to the manufacturer will still provide a meaningful measure of the health of the battery. We also believe that requiring the SOH to be customer-accessible will provide assurance that the SOH monitor is relatively accurate.

For PHEV, manufacturers will use the existing powertrain test procedures defined in 40 CFR 1036.545 to determine UBE, or a manufacturer-specific alternative test procedure.<sup>877</sup> The regulatory powertrain test procedures require that PHEVs be tested in charge depleting and charge sustaining modes using a range of vehicle configurations. Under the final procedure, PHEV manufacturers would select the most representative vehicle configuration to determine UBE for the powertrain family. In addition to this test procedure, the final rule allows manufacturers to develop and get EPA approval of their own test procedures for determining UBE for PHEV. We are finalizing this option since some manufacturers may use the same battery pack for their BEV and PHEV products, and using the same procedure will reduce testing burden and variability in the determination of UBE.<sup>878</sup>

<sup>877</sup> We are moving the existing powertrain procedure from its current location in 40 CFR 1037.550 to the heavy-duty highway engine provisions as a new 40 CFR 1036.545. See section III.C.3 of this preamble for more information.

<sup>878</sup> This flexibility is in response to a comment that we received from Cummins, that is summarized in RTC section 11.

Along with these provisions allowing manufacturers to develop their own test procedure for determining UBE for BEV or for PHEV, we are finalizing specific criteria for such a test procedure to ensure it produces accurate results that are representative of in-use operation. These provisions bound the parameters of each manufacturer-specific test procedure. The first requirement is that the test procedure must measure UBE by discharging the battery at a constant power that is representative of the vehicle cruising on the highway. For many HD vehicles the power to cruise on the highway would result in a C-rate between C/6 and C/2.<sup>879</sup> The second requirement is that the test is complete when the battery is not able to maintain the target power. The third requirement is that the battery energy measurements must meet the requirements defined in 40 CFR 1036.545(a)(10). The final requirement is that the SOH monitor must be able to determine the UBE within +/- 5 percent of the result of the test procedure. The finalized accuracy requirement for the SOH monitor is supported by GTR No. 22 and by comments to the proposal.

We requested comment on finalizing a state-of-certified-range (SOCR) monitor. 88 FR 26015. In response, we received one comment supporting EPA finalizing an SOCR monitor and many comments in opposition. As stated by some commenters, the range of a HD BEV is highly dependent on the duty cycle and payload of the vehicle. Since an SOCR monitor is not likely to provide useful information to the driver, we are not finalizing a requirement for an SOCR monitor at this time. A complete list of the comments and our response can be found in section 11 of the response to comments document.

We believe that the new requirement to have an SOH monitor, buttressed by the manufacturer-specific test for determining UBE, will assure that these vehicles meet standards throughout their useful life, per sections 202(a)(1) and 202(d) of the CAA. In addition, the SOH monitor should provide consumers with assurance of durability, and an ability to monitor it.

In addition, under the EPA GHG program, BEV and PHEV generate credits that can be traded among manufacturers and used to offset deficits generated by vehicles using other technologies that do not themselves meet the standards, as well as used to offset debits generated by the

<sup>879</sup> C-rate is a measure of the rate at which a battery is discharged or charged relative to its maximum capacity and has units of inverse hours. At a 2C discharge rate, it would take 0.5 hours to fully discharge a battery.



manufacturer's own fleet (*i.e.*, vehicle families across each averaging set). Part of the credit-generating calculation is the useful life of the vehicle, as specified in 40 CFR 1037.105(e) and 1037.106(e). See 40 CFR 1037.705(b) (formula). If credits generated by vehicles using these powertrains are used to offset debits created by other vehicles on an equivalent basis, it is important that the vehicles achieve this specified useful life mileage—mileage equivalent to what is expected for an ICE vehicle. For BEV and PHEV, this depends, in substantial part, on the life of the battery. The durability provisions in this final rule, plus the warranty provisions described in the following preamble section, provide additional assurance that the battery will perform over this useful life mileage. Again, the durability provisions in this rule help provide a safeguard.

## 2. Battery and Fuel Cell Electric Vehicle Component Warranty

Recognizing that BEV, PHEV, and FCEV are playing an increasing role in manufacturers' compliance strategies we proposed new warranty requirements for BEV and FCEV batteries and associated emission-related components (*e.g.*, fuel-cell stack, electric motors, and inverters) and proposed to clarify how existing warranty requirements apply for PHEVs. In response to this proposal, we received many comments supporting the proposed warranty requirements. We also received comments encouraging EPA to define which components are covered and what failures are covered under the warranty. A complete list of the comments and our responses is included in section 11.2 of the response to comments document.

In consideration of the comments and that BEV, PHEV, and FCEV are playing an increasing role in manufacturers' compliance strategies, we are identifying the high-voltage battery, and the powertrain components that depend on it (including fuel-cell stack, electric motors, and inverters), as "emission-related components" in HD vehicles under 40 CFR 1037.120(c) (components covered by warranty), as they play a critical role in reducing the vehicles' emissions and allowing BEV and FCEV to have zero tailpipe emissions in-use, see section I.B of this preamble. As EMA notes in its comments, "[t]raditional emission-related warranty requirements serve the useful purpose of motivating a trucking company to keep the emissions control systems functioning properly throughout each vehicle's useful life."

As such, we are finalizing new warranty requirements for MY 2027 and

later BEV and FCEV batteries and associated emission-related electric powertrain components (*e.g.*, fuel-cell stack, electric motors, and inverters) under the authority of CAA section 207(a)(1) and clarifying how existing warranty requirements apply for PHEVs.<sup>880</sup> The battery warranty requirements we describe in this section build on existing emissions warranty provisions for other emission-related components by establishing specific new requirements tailored to the emission control-related role of the high-voltage battery and fuel-cell stack in durability and performance of BEVs and FCEV.

EPA believes that this practice of ensuring a minimum level of warranty protection for emissions-related components on ICE vehicles, including hybrid vehicles, should be extended to the high-voltage battery and other electric powertrain components of BEVs and FCEVs for multiple reasons. Recognizing that BEVs and FCEVs are playing an increasing role in manufacturers' compliance strategies, the high-voltage battery and the powertrain components that depend on it are emission control devices critical to the operation and emission performance of BEVs and FCEVs, as they play a critical role in allowing BEVs and FCEVs to operate with zero tailpipe emissions. Further, EPA anticipates that compliance with the program is likely to be achieved with larger penetrations of BEVs and FCEVs than under the previous program. Although the projected emissions reductions are based on a spectrum of control technologies, in light of the cost-effective reductions achieved, especially by BEV and FCEVs, EPA anticipates most if not all manufacturers will include credits generated by BEVs and FCEVs as part of their compliance strategies, even if those credits are obtained from other manufacturers; thus this is a particular concern given that the calculation of credits for averaging (as well as banking and trading) depend on the battery and emission performance being maintained for the full useful life of the vehicle. Additionally, warranty provisions are a strong complement to the battery durability requirements described in the previous section. We believe that a component under warranty is more likely to be properly maintained and repaired or replaced if it fails, which would help ensure that credits granted for BEV and FCEVs sales represent real

emission reductions achieved over the life of the vehicle.

We did not propose new battery warranty requirements for PHEVs. As "hybrid system components" they already have warranty requirements under the existing regulations in 40 CFR parts 1036 and 1037. In the HD2027 low NO<sub>x</sub> rule, we finalized a provision stating that when a manufacturer's certified configuration includes hybrid system components (*e.g.*, batteries, electric motors, and inverters), those components are considered emission-related components, which would be covered under the warranty requirements (see, *e.g.*, 88 FR 4363, January 24, 2023, and 40 CFR 1036.120).

We are revising 40 CFR 1036.120(c) to clarify that the warranty requirements of 40 CFR part 1036 apply to hybrid system components for any hybrid manufacturers certifying to the part 1036 engine standards. In 40 CFR 1037.120(c), we are also finalizing our proposal to remove the sentence stating that the emission-related warranty does not need to cover components whose failure would not increase a vehicle's emissions of any regulated pollutant, and replacing this sentence with "and any other components whose failure would increase a vehicle's CO<sub>2</sub> emissions" to the existing sentence that states the emission-related warranty covers components included in the application for certification.

In response to the comments stating that EPA should define which components are covered and what failures are covered under the emissions warranty, we have made the following changes. First, we are clarifying that the RESS (also known as the high-voltage battery) and associated electric powertrain components in the vehicle's application for certification are covered under the emission-related warranty. Second, we are finalizing text in 40 CFR 1037.205(b) stating that "For any vehicle using RESS (such as hybrid vehicles, FCEV, and BEV), describe in detail all components needed to charge the system, store energy, and transmit power to move the vehicle."<sup>881</sup> By making these two changes we believe that we have defined which components are covered, while leaving the requirements general enough to cover technologies that are not currently in the market. As for the comments on defining what failures are covered under the emissions warranty, we are not

<sup>880</sup> See section I.D. of this preamble and in this section III.B for further discussion of EPA's authority under CAA section 207(a)(1).

<sup>881</sup> Rechargeable Energy Storage System (RESS) means engine or equipment components that store recovered energy for later use to propel the vehicle or accomplish a different primary function. Examples of RESS include the battery system or a hydraulic accumulator in a hybrid vehicle.

finalizing any changes, as the current warranty requirements already provide the framework for manufacturers to define the specific failures that are covered under warranty, as they have done for many years. We also received comment that only the high-voltage battery and fuel cell should be covered by the emissions warranty. Although we agree that the high-voltage battery and fuel cell should be covered, these are not the only components that enable ZEV to have a zero CO<sub>2</sub> grams per mile from the tailpipe. These reductions are also dependent on the components that allow charging the system, storing energy, and transmitting power to move the vehicle, and as such we are requiring manufacturers to include these components in the vehicle's application for certification and cover them with the emissions warranty. We are finalizing as proposed that those components be covered by the existing regulations' emissions warranty periods of 5 years or 50,000 miles for Light HDV and 5 years or 100,000 miles for Medium HDV and Heavy HDV (see revisions to 40 CFR 1037.120).

The warranty provisions are a strong complement to the proposed battery durability monitoring requirements. As explained, EPA anticipates that most if not all manufacturers would include the averaging of credits generated by BEVs and FCEVs as part of their compliance strategies for the final standards. Thus, as noted in the previous section on durability, emission credits would be calculated assuming the battery sufficiently maintains its performance for the full useful life of the vehicle. 40 CFR 1037.705(b) (formula). We believe a component under warranty is more likely to be properly maintained and repaired or replaced if it fails, which could help ensure that credits granted for BEV and FCEV production volumes represent real emission reductions achieved over the life of the vehicle. Finally, we expect many manufacturers will provide warranties beyond the existing 40 CFR 1037.120 levels for the BEV and FCEV they produce, and the new requirements to require those warranty periods and document them in the owner's manual would provide additional assurance for owners that all BEV and FCEV have the same minimum warranty period.<sup>882</sup>

<sup>882</sup> For example, the Freightliner eCascadia includes a powertrain warranty of 5 year/150,000 or 300,000 miles (depending on battery pack size). Available at: [https://dtnacontent-dtna.prd.freightliner.com/content/dam/enterprise/documents/DDCTEC%2016046%20-%20eCascadia%20Spec%20Sheet\\_6.0.pdf](https://dtnacontent-dtna.prd.freightliner.com/content/dam/enterprise/documents/DDCTEC%2016046%20-%20eCascadia%20Spec%20Sheet_6.0.pdf) (last accessed October 30, 2023). In addition, Type C BEV school bus battery warranty range five to

### C. Additional Revisions to the Regulations

In this subsection, we discuss revisions to 40 CFR parts 1036, 1037, and 1065. After consideration of comments,<sup>883</sup> many of the updates described in this section I.C.5 we are finalizing as proposed, however in some cases we have updated the final revisions from those proposed and are finalizing additional clarifications and editorial corrections. We intend for the changes to testing and other certification procedures finalized in this rule to be entirely separate from the Phase 3 emissions standards and other varied components of this rule, and severable from each other. These are changes EPA is making related to implementation of standards generally (*i.e.*, independent of the numeric stringency of the standards set in this final rule). EPA has considered and adopted changes to testing and other certification procedures and the remaining portions of the final rule independently, and each is severable should there be judicial review. If a court were to invalidate any one of these elements of the final rule, the remainder of this action remains fully operable, as we have designed the program to function even if one part of the rule is set aside.

#### 1. Updates for Cross-Sector Issues

This section includes updates that make the same or similar changes in related portions of the CFR or across multiple standard-setting parts for individual industry sectors.

##### i. LLC Cycle Smoothing and Accessory Load

We finalized a new LLC duty-cycle in the HD2027 rule that included a test procedure for smoothing the nonidle nonmotoring points immediately before and after idle segments within the duty-cycle.<sup>884</sup> It was brought to our attention that the smoothing procedure in 40 CFR 1036.514(c)(3) allows smoothing based on the idle accessory torque but says nothing about how to address the

fifteen years according to [https://www.nyapt.org/resources/Documents/WRI\\_ESB-Buyers-Guide\\_US-Market\\_2022.pdf](https://www.nyapt.org/resources/Documents/WRI_ESB-Buyers-Guide_US-Market_2022.pdf). Lastly, the Freightliner electric walk-in van includes an eight-year battery warranty according to <https://www.electricwalkinvan.com/wp-content/uploads/2022/05/MT50e-specifications-2022.pdf>.

<sup>883</sup> EPA participates in on-going Emissions Measurement & Testing Committee meetings and notes that certain clarifying and editorial revisions included in the final rule described in this section I.I.C were supported by the engine and vehicle manufacturers and other industry stakeholders participating in those meetings. See memo to docket EPA-HQ-OAR-2022-0985: Laroo, Christopher. "Test Procedure Meetings with the Engine Manufacturers Association".

<sup>884</sup> 88 FR 4296 (January 24, 2023).

contribution of curb idle transmission torque (CITT), while 40 CFR 1065.610(d)(3)(v) through (viii) requires smoothing based on CITT and says nothing about how to address idle accessory torque. This could create confusion and difficulties for common cases where CITT is required in addition to the 40 CFR 1036.514 idle accessory torques. 40 CFR 1036.514(c)(3), as currently written, would only apply if the transmission was in neutral, because it only allows you to account for the accessory load and not CITT, which was not EPA's intent. To illustrate the concern, for example, a MHD engine could have an LLC idle accessory load of 23.5 foot-pounds, which is 19 percent of a typical automatic transmission CITT of 124 foot-pounds. To resolve this potential issue, we are removing the smoothing instructions in 40 CFR 1036.514 and incorporating them into 40 CFR 1065.610.

The original intent of the 40 CFR 1065.610 duty-cycle generation procedure was to avoid discontinuities in the reference torque values. It was written with the assumption that idle load in neutral was zero, meaning the vehicle or machine idle accessory load was zero. When we introduced the required LLC idle accessory load in 40 CFR 1036.514, we failed to realize that amendments would be needed to 40 CFR 1065.610(d)(3) to clarify how to handle the accessory load in the denormalization process. The engine mapping section 40 CFR 1065.510 is another area of concern as it does not address the possibility of droop in the idle governor, which would result in different idle speeds when the transmission is in drive versus neutral. This results in an additional complication as the required idle accessory torque will be different in drive versus neutral to keep the accessory power at the level specified in table 1 to 40 CFR 1036.514(c)(4).

Paragraph (d)(4) of 40 CFR 1065.610 is a related paragraph that allows a different deviation for an optional declared minimum torque that applies to variable- and constant-speed engines and both idle and nonidle nonmotoring points in the duty-cycle. Its scope of application is wider than 40 CFR 1065.610(d)(3). Paragraph (d)(4) of 40 CFR 1065.610 applies to all nonidle nonmotoring points in the duty-cycle, not just the ones immediately preceding or following an idle segment and using it instead of paragraph (d)(3) would not get the intended constant idle accessory power loads or the intended smoothing.

There is also an existing historical conflict between 40 CFR 1065.510(f)(4)

and 1065.610(d)(4). Paragraph (f)(4) of 40 CFR 1065.510 requires that manufacturers declare non-zero idle, or minimum torques, but 40 CFR 1065.610(d)(4), permissible deviations, make their use within the duty-cycle generation optional. This results in an inconsistency between the two sections as 40 CFR 1065.510(f)(4) requires these parameters to be declared, but 40 CFR 1065.610(d)(4) does not require them to be used.

Additionally, there is a historical conflict in 40 CFR 1065.610(d)(3)(v). This paragraph, as written, includes zero percent speed and, if the paragraph is executed in the order listed, it would include idle points that were changed to neutral in the previous step for neutral while stationary transmissions. This conflict would change the torque values of those idle-in-neutral points back to the warm-idle-in-drive torque and the speed would be left unaltered at the idle-in-neutral speed. This was clearly not the intent of this paragraph, yet we note that this conflict existed already for regulations that applied to model year 1990 engines.

The smoothing of idle points also raises the need for smoothing of the few occurrences of non-idle points in the duty cycle where the vehicle may be moving, the torque converter may not be stalled, and the warm-idle-in-drive torque may not be appropriate. This would result in the smoothing of consecutive points around nonidle nonmotoring points with normalized speed at or below zero percent and reference torque from zero to the warm-idle-in-drive torque value where the reference torque is set to the warm-idle-in-drive torque value.

To address these concerns, we are revising 40 CFR 1065.510, 1065.512, and 1065.610. Note, other changes to these subsections not specifically mentioned here are edits to fix citations to relocated or new paragraphs and to improve the clarity of the test procedures. The changes to 40 CFR 1065.610 include basing the smoothing of points preceding an idle segment and following an idle segment on the warm-idle-in-drive torque value (sum of CITT and idle accessory torque). Exceptions to this are for manual transmissions and for the first 24 seconds of initial idle segments for automatic transmissions. Here the warm-idle-in-neutral torque value (idle accessory torque) is used. We are including manual transmissions in the required deviations for reference torque determination for variable-speed engines in 40 CFR 1065.610(d)(3) for completeness. The amendments to 40 CFR 1065.610(d)(3) include the option to skip these deviations for a manual

transmission where optional declared idle torque and the optional declared power are not declared (idle torque is zero). This provides labs that have not yet implemented these required deviations the option to not implement them if they only need to run tests with manual transmissions with zero idle torque. We also add manual transmissions to 40 CFR 1065.512(b)(2) where these required deviations in 40 CFR 1065.610 are cited.

We are also revising 40 CFR 1065.510(b) and (f) to address the effect of droop in the idle governor and how to determine idle speed when idle torque is a function of idle speed (where a component is specified as power or CITT is specified as a function of speed and the idle speeds need to be determined for each setpoint of the idle governor). We are also adding an option to declare the warm idle speed(s) equal to the idle speed setpoint for electronically governed variable-speed engines with an isochronous low-speed governor. Recent updates to the mapping test procedure in 40 CFR 1065.510 assumed that one could declare the warm idle speed(s) equal to the idle speed setpoint for electronically governed variable-speed engines when running the map at the minimum user-adjustable idle speed setpoint and using the map for any test.<sup>885</sup> We are finalizing the proposed changes to make it clear that this option is allowed, which would help simplify the mapping process.

To resolve the conflict between 40 CFR 1065.510(f)(4) and 1065.610(d)(4), we are moving the requirement to declare torques to 40 CFR 1065.510(f)(5), which would clarify it is optional and consistent with 40 CFR 1065.610(d)(4).

To resolve the conflict in 40 CFR 1065.610(c)(3)(v), which we are redesignating as 40 CFR 1065.610(c)(3)(vii), we are revising the applicability of the paragraph from “all points” to limit it to apply to “all nonidle nonmotoring points.” To address the smoothing of consecutive nonidle nonmotoring points that immediately follow and precede any smoothed idle points we are changing the reference torques to the warm-idle-in-drive torque value by adding a new 40 CFR 1065.610(c)(3)(xi).

We are also reorganizing 40 CFR 1036.514 and revising the section to clarify the process for cycle denormalization of speed and torque where accessory load is included and to add more specific transmission shift points for greater than 200 seconds idle

segments for LLC engine and hybrid powertrain testing. Shifting the transmission to neutral during very long idle segments is more representative of in-use operation than leaving it in drive, so we proposed and are finalizing more specific shift points instead of a range to reduce lab-to-lab variability. The new shift points include setting the reference speed and torque values to the warm-idle-in-drive values for the first three seconds and the last three seconds of the idle segment for an engine test, keeping the transmission in drive for the first 3 seconds of the idle segment, shifting the transmission from drive to park or neutral immediately after the third second in the idle segment, and shifting the transmission into drive again three seconds before the end of the idle segment.

#### ii. Calculating Greenhouse Gas Emission Rates

We are revising 40 CFR 1036.550(b)(2) and 1054.501(b)(7) to clarify that when determining the test fuel’s carbon mass fraction,  $W_C$ , the fuel properties that must be measured are  $E = 8153 \leq \alpha/E \leq$  (hydrogen) and  $\beta$  (oxygen). These paragraphs, as currently written, imply that you cannot use the default fuel properties in 40 CFR 1065.655 for  $\alpha$ ,  $\beta$ ,  $\gamma$  (sulfur), and  $\delta$  (nitrogen). The fuel property determination in 40 CFR 1065.655(e) makes it clear that if manufacturers measure fuel properties and the default  $\gamma$  and  $\delta$  values for their fuel type are zero in Table 2 to 40 CFR 1065.655, manufacturers do not need to measure those properties. The sulfur ( $\gamma$ ) and nitrogen ( $\delta$ ) content of these highly refined gasoline and diesel fuels are not enough to affect the  $W_C$  determination and the original intent was to not require their measurement. We expect the revisions to reduce confusion on the fuel properties requirement. We are also adding a reference to 40 CFR 1065.655(e) in 40 CFR 1036.550(b)(2) and 1054.501(b)(7) so that they point to the default fuel property table whose number had been previously changed and we did not make the corresponding update in 40 CFR 1036.550(b)(2) and 1054.501(b)(7).

#### iii. ABT Reporting

We are finalizing a proposed allowance for manufacturers to correct previously submitted vehicle and engine GHG ABT reports, where a mathematical or other error in the GEM-based or fleet calculations used for compliance was discovered after the September 30 deadline for submitting the final report. In the Phase 1 program, EPA chose the deadline for submitting a final GHG ABT report to coincide with

<sup>885</sup> 88 FR 4296 (January 24, 2023)

existing criteria pollutant report requirements that manufacturers follow for heavy-duty engines.<sup>886</sup> The deadline was based on our interest in manufacturers maintaining good quality assurance/quality control (QA/QC) processes in generating ABT reports. We continue to believe that aligning the ABT report deadlines for criteria and GHG pollutants can provide consistency within a manufacturer's certification and compliance processes, but further consideration of the inherent differences and complexities in how credits are calculated and accounted for in the two programs led us to consider a time window beyond 270 days for allowing corrections to the GHG report. Certifying an engine or vehicle fleet with attribute-based features (Phase 1) or GEM (Phase 2) involves a greater risk of error compared to EPA's engine or vehicle test-based programs for criteria pollutants, where direct measurement of criteria pollutant emissions at time of certification is well established. Whether an indirect, physics-based model for quantifying GHG emissions such as GEM, or a unique technology-, attribute-, or engine production volume-based credit accounting system, unintentional errors, if not detected prior to submitting the final GHG ABT report and not realized until the accounting process for the following model year was initiated, could negatively affect a manufacturer's credit balance. For example, the loss of these credits could result in a manufacturer purchasing credits or making unplanned investments in additional technologies to make up for the credits lost due to the report error.

Under the revisions to 40 CFR 1036.730(f) and 1037.730(f), EPA would consider requests to correct previously submitted MY 2021 or later ABT reports only when notified of the error within 24 months from the September 30 final report deadline. For requests to correct reports for MY 2020 or earlier, we have set an interim deadline of October 1, 2024 (see new 40 CFR 1036.150(aa) and 1037.150(y)). We believe that corrections to ABT reports, where justified, will have no impact on emissions compliance as the actual performance of a manufacturer's fleet was better than what was reported in error, and correcting the report simply adjusts the credit balance for the model year in question to the appropriate value, such that those credits can then be used in future model years.

This narrowly focused allowance for correcting accounting, typographical, or

GEM-based errors after a manufacturer submits the 270-day final report (see revisions in 40 CFR 1037.730) is intended to address the disproportionate and adverse financial impact of an unintentional error in the complex modeling and accounting processes that manufacturers use to determine compliance and credit balances for a given model year. We proposed and are finalizing a 10 percent discount to these credit corrections to the final report, which will reduce the value of the credits that are restored upon approval of the request. The 10 percent discount is intended to balance the goal of encouraging accuracy in ABT reports and use of robust QA/QC processes against the considerations for allowing manufacturers the ability to correct unforeseen errors.

iv. Migration of 40 CFR 1037.550 to 40 CFR 1036.545

We are migrating the powertrain test procedure from the heavy-duty motor vehicle regulations in 40 CFR part 1037 to the heavy-duty highway engine regulations in 40 CFR part 1036. Specifically, we are migrating the procedure from 40 CFR 1037.550 to 40 CFR 1036.545. Over the course of the development of this test procedure, its use expanded to include certification of engines to the criteria pollutant standards in 40 CFR part 1036 (including test procedures in 40 CFR 1036.510, 1036.512, and 1036.514) and the procedure can be used in place of the engine GHG testing procedures (40 CFR 1036.535 and 1036.540) for hybrid engines and hybrid powertrains. We are migrating the test procedure to 40 CFR 1036.545 as-is, with the following exceptions:

We are adding a new figure that provides an overview of the steps involved in carrying out testing under this section.

We are clarifying the use of the GEM HIL model contained within GEM Phase 2, Version 4.0 if it is used to simulate a vehicle's automatic transmission. If the engine is intended for vehicles with automatic transmissions, the manufacturer must use the cycle configuration file in GEM to change the transmission state (either in-gear or idle) as a function of time as defined by the duty cycles in 40 CFR part 1036.

We are clarifying the recommended means to control and apply the electrical accessory loads for powertrains tested over the LLC duty cycle.

We are clarifying that if the test setup has multiple locations where torque is measured and speed is controlled, the manufacturer is required to sum the

measured torque and validate that the speed control meets the requirements defined in 40 CFR 1036.545(m). Positive cycle work,  $W_{[cycle]}$ , would then be determined by integrating the sum of the power measured at each location in 40 CFR 1036.545(o)(7).

We are also clarifying that manufacturers may test the powertrain with a chassis dynamometer as long as they measure speed and torque at the powertrain's output shaft or wheel hubs.

We are replacing all references to 40 CFR 1037.550 throughout 40 CFR parts 1036 and 1037 with new references to 40 CFR 1036.545. We are clarifying that when creating GEM inputs, if speed and torque are measured at more than one location, determine  $W_{[cycle]}$  by integrating the sum of the power calculated from speed and torque measurements at each location.

Finally, we received comment from multiple stakeholders that improvements are needed to reduce the test burden of the hybrid powertrain test procedure. As discussed in RTC section 24.1.4, many of these suggested changes are out of scope for this rule. However, EPA is constantly reviewing its test procedures and in the future EPA intends to work with manufacturers and stakeholders to further streamline hybrid certification.

v. Median Calculation for Test Fuel Properties in 40 CFR 1036.550

The regulation at 40 CFR 1036.550 currently requires the use of the median value of measurements from multiple labs for the emission test fuel's carbon-mass-specific net energy content and carbon mass fraction for manufacturers to determine the corrected CO<sub>2</sub> emission rate using equation 1036.550-1 in 40 CFR 1036.550. The current procedure does not provide a method for determining the median value. We proposed to add a new calculation for the median value in the statistics calculation procedures of 40 CFR 1065.602 as a new paragraph (m) to ensure that labs are using the same method to calculate the median value. We also proposed to reference the new paragraph (m) in 40 CFR 1036.550(a)(1)(i) and (a)(2)(i) for carbon-mass-specific net energy content and carbon mass fraction, respectively. We are finalizing the new median calculation procedure as proposed.

2. Updates to 40 CFR Part 1036 Heavy-Duty Highway Engine Provisions

i. Manufacturer Run Heavy-Duty In-Use Testing

We are adding a clarification to 40 CFR 1036.405(d) regarding the starting

<sup>886</sup> See the HD GHG Phase 1 rule (76 FR 57284, September 15, 2011).

point for the 18-month window manufacturers have to complete an in-use test order. Under the current provision, the clock for the 18-month window starts after EPA has received the manufacturer's proposed plan for recruiting, screening, and selecting vehicles. There is concern that manufacturers could delay testing by unnecessarily prolonging the selection process. To alleviate this concern and keep the testing timeline within the originally intended 18-month window, we are revising the 18-month window to start when EPA issues the order for the manufacturer to test a particular engine family.

In the HD2027 final rule, we adopted a new 40 CFR 1036.420 that includes the pass criteria for individual engines tested under the manufacturer run in-use testing program. Table 1 to 40 CFR 1036.420 contains the accuracy margins for each criteria pollutant. We are correcting an inadvertent error in the final rule's amendatory text for the regulations that effects the accuracy margin for carbon monoxide (CO), which is listed in Table 1 as 0.025 g/hp-hr. The HD2027 preamble is clear that the CO accuracy margin that we finalized was intended to be 0.25 g/hp-hr and we are correcting Table 1 to reflect the value in that rule's preamble.<sup>887</sup>

ii. Low Load Cycle (LLC)—Cycle Statistics

We are updating 40 CFR 1036.514 to address the ability of gaseous fueled non-hybrid engines with single point fuel injection to pass cycle statistics to validate the LLC duty cycle. In 40 CFR 1036.514(e), we referenced, in error, the alternate cycle statistics for gaseous fueled engines with single point fuel injection in the cycle average fuel map section in 40 CFR 1036.540(d)(3) instead of adding LLC specific cycle statistics in 40 CFR 1036.514(e). We are adding a new table 2 in 40 CFR 1036.514(b) to provide cycle statistics that are identical to those used by the California Air Resources Board for the LLC and to remove the reference to 40 CFR 1036.540(d)(3) in 40 CFR 1036.514(e).

iii. Low Load Cycle (LLC)—Background Sampling

We are removing the provision in 40 CFR 1036.514(d) that allows periodic background sampling into the bag over the course of multiple test intervals

<sup>887</sup> See HD2027 final rule preamble (88 FR 4353, January 24, 2023) ("PEMS measurement allowance values in 40 CFR 86.1912 are 0.01 g/hp-hr for HC, 0.25 g/hp-hr for CO, 0.15 g/hp-hr for NO<sub>x</sub>, and 0.006 g/hp-hr for PM. We are maintaining the same values for HC, CO, and PM in this rulemaking.")

during the LLC because the allowance to do this is covered in 40 CFR 1065.140(b)(2). The LLC consists of a very long test interval and the intent of the provision was to address emission bag sampling systems that do not have enough dynamic range to sample background constantly over the entire duration of the LLC. Paragraph (b)(2) of 40 CFR 1065.140 affords many flexibilities regarding the measurement of background concentrations, including sampling over multiple test intervals as long as it does not affect manufacturers' ability to demonstrate compliance with the applicable emission standards. The final revisions to 40 CFR 1036.514(d) include additional edits for clarification and consistency with other final revisions.

iv. Determining Vehicle C Speed Values for Powertrain Testing

We are finalizing changes to 40 CFR 1036.520 to make the procedure more robust at determining a representative vehicle C speed. For powertrains where there is no power interrupt as the transmission shifts through gears, the test procedure can result in an unrepresentatively high vehicle C speed. This is because the test procedure assumes maximum powertrain power as a function of speed for each gear will start low, and then reach the peak power before dropping again. If the powertrain does not have multiple speeds where the power is equal to 98 percent of peak power, the vehicle C speed is the highest speed in top gear. The finalized changes to the procedure in 40 CFR 1036.520(j)(1) address this by using the lowest vehicle speed in top gear in place of the minimum vehicle speed where power is greater than 98 percent of peak power. We are also adding a new 40 CFR 1036.520(j)(3) to allow manufacturers to use a declared vehicle C speed instead of the measured value if the declared value is within (97.5 to 102.5) percent of the corresponding measured value.

For series hybrids the powertrain may have only one, two or three gears in the transmission or e-axle so the average of the minimum and maximum speeds where power is greater than 98 percent of peak power in top gear, may result in an unrepresentatively low vehicle C speed. To address this issue, we are finalizing a new 40 CFR 1036.520(j)(4), which directs a manufacturer to request EPA approval for a representative vehicle C speed if the procedure results in a vehicle C speed that is lower than the cruise speed of the powertrain.

v. U.S.-Directed Production Volume

In the recent HD2027 rule, we amended the heavy-duty highway engine provision in 40 CFR 1036.205 and several other sections to replace "U.S.-directed production volume" with the more general term "nationwide" where we intended manufacturers report total nationwide production volumes, including production volumes that meet different state standards.

In this rule, for the reasons explained in section I.A.1, we are finalizing a broader change to the definition in 40 CFR 1037.801 such that the phrase "U.S.-directed production volume" no longer excludes production volumes for vehicles certified to different state standards. We are similarly updating the definition of "U.S.-directed production volume" for engines in 40 CFR 1036.801 to maintain consistency between the engine and vehicle regulatory definitions. We are also reinstating, as proposed, the term "U.S.-directed production volume" where we previously used "nationwide" in 40 CFR part 1036 to avoid having two terms with the same meaning.<sup>888</sup>

As noted in the proposal, the NO<sub>x</sub> ABT program for HD engines in part 1036 excludes production volumes certified to different state standards in its credit calculations, and we proposed clarifying updates throughout 40 CFR part 1036 to ensure no change to those existing exclusions in tandem with the proposed change to the definition of the term "U.S.-directed production volume." Most notably, we proposed a new 40 CFR 1036.705(c)(4) as the location where we exclude engines certified to different state emission standards from being used to calculate emission credits in the HD engine program.<sup>889</sup> Two commenters suggested revisions to the proposed 40 CFR 1036.705(c)(4), indicating manufacturers may certify their engines to both California and Federal standards to ensure that engines can be sold nationwide. Under the proposed definition, manufacturers would not be allowed to include engines certified to the California standards in their credit calculations, even if the engine was never sold in California (or in a state that adopted California standards). After considering these comments and noting that we never intended to discourage manufacturers from certifying a

<sup>888</sup> We proposed and are finalizing revisions in 40 CFR 1036.205(v), 1036.250(a), 1036.405(a), 1036.605(e), 1036.725(b), and 1036.730(b).

<sup>889</sup> We are finalizing as proposed the revision to move the statement to keep records relating to those production volumes from its current location in 40 CFR 1036.705(c) to 40 CFR 1036.735 with the other ABT recordkeeping requirements.

complete engine family to California-level standards, we are further revising the proposed provision to exclude engines if they are certified to different state standards and intended for sale in a state that adopted those different emission standards.<sup>890</sup>

vi. Correction to NO<sub>x</sub> ABT FEL Cap

We are finalizing an amendment to 40 CFR 1036.104 to remove paragraph (c)(2)(iii) which corresponds to a FEL cap of 70 mg/hp-hr for MY 2031 and later Heavy HDE that we proposed in HD2027 but did not intend to include in the final amendatory text. In the final rule for the HD2027 rule, we did not intend to include in the final amendatory text paragraph (c)(2)(iii) alongside the final FEL cap of 50 mg/hp-hr for MY 2031 and later which applies to all HD engine service classes including Heavy HDE in paragraph (c)(2)(ii) described by EPA in the preamble and supporting rule record. We are finalizing the correction of this error and removing paragraph (c)(2)(iii). This correction will not impact the stringency of the final NO<sub>x</sub> standards because even without correction paragraph (c)(2)(ii) controls.<sup>891</sup>

vii. Rated Power and Continuous Rated Power Coefficient of Variance in 40 CFR 1036.520

We are finalizing the correction of an error and a revision to a provision we intended to include in HD2027, regarding determining power and vehicle speed values for powertrain testing. In 40 CFR 1036.520, paragraphs (h) and (i) describe how to determine rated power and continuous rated power, respectively, from the 5 Hz data in paragraph (g) averaged from the 100 Hz data collected during the test. We inadvertently left out the coefficient of variance (COV) limits of 2 percent that are needed for making the rated and continuous rated power determinations in the HD2027 final 40 CFR 1036.520(h) and (i), which were intended to be based on the COVs calculated in 40 CFR 1036.520(g) and we correctly included in the HD2027 final 40 CFR 1036.520(g). We are adding the 2 percent COV limit in 40 CFR 1036.520(h) and (i). We are

<sup>890</sup> We are finalizing as proposed revisions that replace several instances of “U.S.-directed production volume” with a more general “production volume” where the text clearly is connected to ABT or add a more specific reference to the production volume specified in 40 CFR 1036.705(c). See revisions in 40 CFR 1036.150(d) and (k), 1036.725(b), and 1036.730(b).

<sup>891</sup> As EPA explained in the NPRM and elsewhere in this final rule, EPA did not reopen the final HD2027 standards, or any other portion of that rule besides those specifically identified in the NPRM as subject to new revisions.

also finalizing the correction of a paragraph reference error in 40 CFR 1036.520(h). The paragraph references the data collected in paragraph (f)(2) of the section. The data collection takes place in paragraph (d)(2) of the section.

viii. Selection of Drive Axle Ratio and Tire Radius for Hybrid Engine and Hybrid Powertrain Testing

We are finalizing changes to the drive axle ratio and tire radius selection paragraphs in 40 CFR 1036.510(b)(2)(vii) and (viii), that includes combining the selection process into a single paragraph (b)(2)(vii). When testing hybrid engines and hybrid powertrains a series of vehicle parameters must be selected. The paragraphs for selecting drive axle ratio and tire radius are separate from each other, however the selection of the drive axle ratio must be done in conjunction with the tire radius as not all tire sizes are offered with a given drive axle ratio. We are finalizing the combination of these paragraphs into one to eliminate any possible confusion on the selection of these two parameters.

The maximum vehicle speed for SET testing of hybrid engines and powertrains is determined based on the vehicle parameters and maximum achievable speed for the configuration in 40 CFR 1036.510. This is not the case for the FTP vehicle speed which reaches a maximum of 60 miles per hour. It has been brought to our attention that there are some vehicle configurations that cannot achieve the FTP maximum speed of 60 mile per hour. To resolve this, we are finalizing changes to 40 CFR 1036.510(b)(2)(vii) that instruct the manufacturer to select a representative combination of drive axle ratio and tire size that ensure a vehicle speed of no less than 60 miles per hour. We are also finalizing the inclusion, as a reminder, that manufacturers may request approval for selected drive axle ratio and tire radius consistent with the provisions of 40 CFR 1036.210. We are also finalizing the addition of a provision for manufacturers to follow 40 CFR 1066.425(b)(5) if the hybrid powertrain or hybrid engine is used exclusively in vehicles which are not capable of reaching 60 mi/hr. This allows the manufacturer to seek approval of an alternate test cycle and cycle-validation criteria for powertrains where the representative tire radius and axle ratio do not allow the vehicle to achieve the maximum speeds of the specified test cycle.

ix. Determining Power and Vehicle Speed Values for Powertrain Testing

We are finalizing revisions to 40 CFR 1036.520(d)(2) to address the possibility of clutch slip when performing the full load acceleration with maximum driver demand at 6.0 percent road grade where the initial vehicle speed is 0 mi/hr. The revision allows hybrid engines and hybrid powertrains to increase the initial speed from 0 miles per hour to 5 miles per hour to mitigate clutch slip. This change in initial speed will reduce the extreme force on the clutch when accelerating at 6.0 percent grade. We are not finalizing the second option proposed that allowed modification of the road grade during the first 30 seconds of the full load acceleration, as the option to start at a higher initial speed will do a better job at reducing the effects of the low-end torque, which is the cause of clutch slip.

We are finalizing a revision to 40 CFR 1036.520(d)(3) to address situations where the powertrain does not reach maximum power in the highest gear 30 seconds after the grade setpoint has reached 0.0 percent. To address this we are replacing the 30 second time limit with a speed change stability limit of 0.02 m/s<sup>2</sup> which will trigger the end of the test.

x. Determining Vehicle Mass in 40 CFR 1036.510

We requested comment on updating equation 1036.510–1 of 40 CFR 1036.510 to better reflect the relationship of vehicle mass and rated power. It was brought to EPA’s attention that with the increase in rated power of heavy-duty engines, equation 1036.510–1 of 40 CFR 1036.510 might need updating to better reflect the relationship of vehicle mass and rated power. We are not making any changes to equation 1036.510–1 of 40 CFR 1036.510 at this time because we still consider it to be representative. Further, we requested comment on this issue and received no comments suggesting changes.

xi. Test Procedure for Engines Recovering Kinetic Energy for Electric Heaters

We are finalizing a clarification in the existing definition for hybrid in 40 CFR 1036.801 to add a sentence stating that systems recovering kinetic energy to power an electric heater for the aftertreatment do not qualify as a hybrid engine or hybrid powertrain. Under the existing hybrid definition, systems that recover kinetic energy, such as regenerative braking, are be considered “hybrid components” and

manufacturers were required to use the powertrain test procedures to account for the electric heater or use the engine test procedures and forfeit the emission reductions from heating the aftertreatment system. With this clarification to the hybrid definition, engines that use regenerative braking only to power an electric heater for aftertreatment devices are not considered hybrid engines and, therefore, are not required to use the powertrain test procedures; instead, those engines can use the test procedures for engines without hybrid components.

We are finalizing a supplement to the new definitions with direction for testing these systems in 40 CFR 1036.501. In the new 40 CFR 1036.501(g), we are clarifying that an electric heater for aftertreatment can be installed and functioning when creating fuel maps using 40 CFR 1036.505(b) and measuring emissions over the duty cycles specified in 40 CFR 1036.510(b), 1036.512(b), and 1036.514(b). This allowance is limited to hybrid engines where the system recovers less than 10 percent of the total positive work over each applicable transient cycle and the recovered energy is exclusively used to power an electric heater in the aftertreatment. Since the small amount of recovered energy is stored thermally and can't be used to move the vehicle, we believe that the engine test procedures are just as representative of real-world operation as the powertrain test procedures. The limit of 10 percent is based on the amount of negative work versus positive work typical of conventional engines over the transient cycle. After evaluating a range of HDE, we have observed that the negative work from the transient FTP cycle during engine motoring is less than 10 percent of the positive work of the transient FTP cycle.<sup>892</sup> In the same paragraph (g), we are finalizing an option for manufacturers to use the powertrain test procedures for these systems, which does not have the same restrictions we are finalizing for the amount of recovered energy.

We are finalizing changes to the proposed 40 CFR 1036.501(g), to clarify that for these hybrid engines, the choice to run the powertrain test procedure or the engine test procedure can be made separately for measuring emissions and fuel mapping. The allowance to choose which test procedure to use doesn't allow for a unique decision to be made

for each of the applicable duty cycles in 40 CFR part 1036. For example, you cannot run the powertrain test procedure for the FTP and run the engine test procedure for the SET. In addition, the same test procedure must be used for all pollutants. For example, you may not run the powertrain test procedure for CO<sub>2</sub> and the engine test procedure for NO<sub>x</sub>.

xii. Updates to 40 CFR Part 1036 Definitions

We are finalizing new and updated definitions in 40 CFR 1036.801 in support of several requirements we are finalizing in section II or this section III. We added a reference to two new definitions we are finalizing in 40 CFR part 1065: "Carbon-containing fuel" and "neat". The definition of carbon-containing fuel will help identify the applicable test procedures for engines using fuels that do not contain carbon and would not produce CO<sub>2</sub>. The definition of "neat" indicates that a fuel is not mixed or diluted with other fuels, which helps distinguish between fuels that contain no carbon, such as hydrogen, and fuels that contain carbon through mixing, such as hydrogen where a diesel pilot is used for combustion. We are also updating the definition for "U.S.-directed production volume" of engines to be equivalent to nationwide production, consistent with the updated definition for vehicles in part 1037.

We are consolidating the definitions of hybrid, hybrid engine, and hybrid powertrain into a single definition of "hybrid" with subparagraphs distinguishing hybrid engines and powertrains. The definition of hybrid retains most of the existing definition, except that we have removed the unnecessary "electrical" qualifier from batteries and added a statement relating to recovering energy to power an electric heater in the aftertreatment (see section I.C.2.xi of this preamble). The revised definitions for hybrid engines and powertrains, which are being finalized as subparagraphs under "hybrid", are more complementary of each other with less redundancy. As noted in section I.C.2.xi, we are finalizing updated definitions of hybrid engine and hybrid powertrain to exclude systems recovering kinetic energy for electric heaters.

We are finalizing several editorial revisions to definitions as well. We are updating the definition of mild hybrid such that it is *relating to* a hybrid engine or hybrid powertrain. We are revising the existing definition of small manufacturer to clarify that the employee and revenue limits include

the totals from *all* affiliated companies and added a reference to the definition of affiliated companies in 40 CFR 1068.30.

xiii. Miscellaneous Corrections and Clarifications in 40 CFR Part 1036

We are finalizing as proposed an update to 40 CFR 1036.150(j) to clarify that the alternate standards apply for model year 2023 and earlier loose engines, which is consistent with existing 40 CFR 86.1819–14(k)(8).

We are finalizing an update to the provision describing how to determine deterioration factors for exhaust emission standards in 40 CFR 1036.245 to clarify that it also applies for hybrid powertrains.

xiv. Off-Cycle Test Procedure for Engines That Use Fuels Other Than Carbon-Containing Fuel

We are finalizing a new 40 CFR 1036.530(j) for engines that use fuels other than carbon-containing fuel. The off-cycle test procedures in 40 CFR 1036.530 use CO<sub>2</sub> as a surrogate for engine power. This approach works for engines that are fueled with carbon-containing fuel, since power correlates to fuel mass rate and for carbon-containing fuels, fuel mass rate is proportional to the CO<sub>2</sub> mass rate of the exhaust. For fuels other than carbon-containing fuels, the fuel mass rate is not proportional to the CO<sub>2</sub> mass rate of the exhaust. To address this issue, we are finalizing that for fuels other than carbon-containing fuels, to use engine power directly instead of relying on CO<sub>2</sub> mass rate to determine engine power. For field testing where engine torque and speed are not directly measured, engine broadcasted speed and torque can be used as described in 40 CFR 1065.915(d)(5).

xv. Onboard Diagnostic and Inducement Amendments

EPA is amending specific aspects of 40 CFR 1036.110 and 1036.111 to add clarifications and correct minor errors in the OBD and inducement provisions adopted in the HD2027 final rule.<sup>893</sup> Specifically, EPA is adopting the following amendments, without change from the proposed rule except as noted.

- 40 CFR 1036.110(b)(6): Correcting a reference to the CARB regulation to be consistent with our intent as described in the preamble of the final rule (see 88 FR 4372) to not require under our regulations manufacturer self-testing

<sup>893</sup> As EPA explained in the NPRM and elsewhere in this final rule, EPA did not reopen any aspect of our OBD and inducement provisions other than those clarifications and corrections specifically identified in the NPRM for this section.

<sup>892</sup> Memorandum to Docket EPA–HQ–OAR–2022–0985: "Analysis of Motoring and Positive Cycle Work for Current Heavy-Duty Engines". James Sanchez. April 4, 2023.

and reporting requirements as referenced in 13 CCR 1971.1(l)(4).

- 40 CFR 1036.110(b)(9): Clarifying that the list of data parameters readable by a generic scan tool is limited to components that are subject to existing OBD monitoring requirements (e.g., through comprehensive component requirements in 13 CCR 1971.1(g)(3)). For example, if parking brake status was not included in an engine's OBD certificate, it would not be a required data parameter. The RTC describes a minor change from the proposed rule to clarify that OBD monitoring is relevant both for monitoring specific components, and for monitoring parameters related to those components.

- 40 CFR 1036.110(b)(11): Adding a reference to 13 CCR 1971.5. The final rule referenced 13 CCR 1971.1 to point to OBD testing deadlines; however, there are additional OBD testing deadlines specified in 1971.5.

- 40 CFR 1036.110(c)(1) and 1036.125(h)(8)(iii): Correcting terminology within these provisions by referring to inducements related to "DEF level" instead of "DEF quantity," to make the intent clearer that the system must use the level of DEF in the DEF tank for purposes of evaluating the specified inducement triggering condition. We separately refer to the quantity of DEF injection for managing the functioning of the SCR catalyst, which is unrelated to the level of DEF in the DEF tank.

- 40 CFR 1036.111: Editing for clarity to eliminate confusion with onboard diagnostic terminology. More specifically, the final rule includes edits to adjust inducement-related terminology to refer to "inducement triggering conditions" instead of "fault conditions." Inducement algorithms are executed through OBD algorithms, but the inducement triggers are separate from OBD fault conditions related to the malfunction indicator light.

- 40 CFR 1036.111(a)(2): Clarifying how to determine the inducement speed category when the vehicle has less than 30 hours of accumulated data. The regulation as adopted sets the inducement schedule based on average vehicle speed over the preceding 30 hours of non-idle operation. That instruction will cover most circumstances; however, there is no specific instruction for an inducement triggering condition that occurs before the vehicle accumulates 30 hours of non-idle operation. As described in the final rule, we depend on 30 hours of non-idle operation to establish which inducement schedule is appropriate for a vehicle. We are also aware that a newly purchased vehicle would have

accumulated several hours of very low-speed operation before being placed into service. We are therefore amending the regulation to specify that engines should not be designed to assess the speed category for inducement triggering conditions until the vehicle has accumulated 30 hours of non-idle operation. Manufacturers should instead program engines with a setting categorizing them as high-speed vehicles until they accumulate 30 hours of non-idle operation to avoid applying an inappropriate speed schedule.

- 40 CFR 1036.111(d)(1), table 2: Correcting a typographical error for the middle set of columns to read "Medium-speed" instead of repeating "Low-speed." The table was correctly published in the preamble to the final rule but was incorrectly transcribed in the Code of Federal Regulations (see 88 FR 4378). We are also adding an inadvertently omitted notation in the table to identify the placement of a footnote to the table.

- 40 CFR 1036.111(a)(1): After consideration of a comment received, we are correcting the omission of an alternative DEF level triggering condition. More specifically, this final rule includes a provision allowing for DEF supply falling to 2.5 percent of DEF tank capacity as an acceptable triggering condition for a DEF level inducement. EPA SCR certification guidance documents included a DEF level triggering condition of 2.5 percent DEF tank capacity in 2009, and manufacturers have used this strategy since that time.<sup>894</sup> In the HD2027 NPRM and final rule, we described our intention to finalize an inducement program similar to the approach described in our existing guidance. Some manufacturers may prefer to rely on percent of DEF tank capacity instead of estimating a fill level that corresponds to the time remaining before the tank is empty because there is less need to make assumptions about the vehicle's operating characteristics.

xvi. Engine Data and Information To Support Vehicle Certification

We are finalizing an update 40 CFR 1036.505 to clarify that when certifying vehicles with GEM, for any fuel type not identified in table 1 to paragraph (b)(4) of 40 CFR 1036.550, the manufacturer identifies the fuel type as diesel fuel for engines subject to compression-ignition standards, and identifies the fuel type as gasoline for engines subject to spark-

ignition standards. This change to 40 CFR 1036.505, is intended to clarify what was originally intended for fuels that are not specified in table 1 to paragraph (b)(4) of 40 CFR 1036.550. This clarification addresses the potential situation where, if a fuel is input into GEM other than the fuel types identified in table 1 to paragraph (b)(4) of 40 CFR 1036.550, GEM will output an error.

xvii. Charge-Depleting Criteria Pollutant Test Sequence—40 CFR 1065.510 Figure 1 and 40 CFR 1065.512 Figure 1

We are finalizing updates to the charge-depleting criteria pollutant test sequence figures in 40 CFR 1065.510 for the SET duty-cycle and 40 CFR 1065.512 for the FTP duty-cycle. These updates are not substantive and are intended to provide better visualization of the charge-depleting and charge-sustaining portions of the test sequences as well as which test intervals are relevant for criteria pollutant determination.

xviii. Testing Exemption for Engines Fueled With Hydrogen

As discussed in section II.D.1, hydrogen-fueled internal combustion engines (ICE) are a newer technology under development, and since neat hydrogen fuel does not contain any carbon, H2 ICE fueled with neat hydrogen produce zero HC, CH<sub>4</sub>, CO, and CO<sub>2</sub> engine-out emissions. We recognize that there may be negligible, but non-zero, CO<sub>2</sub> emissions at the tailpipe of H2 ICE that use SCR and are fueled with neat hydrogen due to contributions from the aftertreatment system from urea decomposition. Similarly, CO<sub>2</sub> emissions are attributable to the aftertreatment systems in compression-ignition ICEs. However, the contribution of CO<sub>2</sub> emission due to decomposition of the urea portion of DEF used in the aftertreatment system of diesel fueled ICE is less than 1 percent of the total.<sup>895</sup> Since hydrogen-fueled internal combustion engines must meet the same tailpipe NO<sub>x</sub> standards in 40 CFR 1036.104 as diesel fueled engines, we expect that engine out NO<sub>x</sub> will be at the same level or lower than diesel fueled engines, which would result in the same or lower DEF usage and tailpipe CO<sub>2</sub> emissions. We are therefore finalizing that tailpipe CO<sub>2</sub> emissions from engines fueled with neat hydrogen are deemed to be 3 g/hp-hr, and tailpipe

<sup>894</sup> "Inducement-Related Guidance Documents, and Workshop Presentation," EPA docket memo number EPA-HQ-OAR-2019-0055-0778, October 2021. See Docket Entry EPA-HQ-OAR-2022-0985-78383."

<sup>895</sup> See 81 FR 73553. ". . . urea typically contributes 0.2 to 0.5 percent of the total CO<sub>2</sub> emissions measured from the engine, and up to 1 percent at certain map points."



CH<sub>4</sub>, HC, and CO emissions are deemed to comply with the applicable standards.<sup>896</sup> We are finalizing 3 g/hp-hr as the default CO<sub>2</sub> emission value, since 0.5 percent of the CO<sub>2</sub> emissions of a Phase 2 compliant compression-ignition engine is less than 3 g/hp-hr. The use of the default CO<sub>2</sub> emission value of 3 g/hp-hr is optional and manufacturers may instead conduct testing to demonstrate that the CO<sub>2</sub> emissions for their engine is below 3 g/hp-hr. Note, NO<sub>x</sub> and PM emission testing is required under existing 40 CFR part 1036 for engines fueled with neat hydrogen.

xix. Emergency Vehicle Provisions

We are adding several provisions to 40 CFR part 1036 to restore what was originally adopted in 40 CFR part 86. The effort to migrate emission standards and certification requirements improperly omitted several provisions related to the allowance for manufacturers to design their engines with AECs that override a derate condition for qualifying emergency vehicles. Specifically, we are revising 40 CFR 1036.115(h)(4) to clarify that emissions standards do not apply when AECs for emergency vehicles are active. We are adding text to 40 CFR 1036.501(e) to allow manufacturers to disable such approved AECs for emergency vehicles during testing. We are also adding text to 40 CFR 1036.580(d) to instruct manufacturers to disregard approved AECs for emergency vehicles when they determine Infrequent Regeneration Adjustment Factors. Finally, we are revising the definition of “emergency vehicle” in 40 CFR 1036.801 to allow for qualifying as an emergency vehicle if it has characteristics that support an expectation that it will be used in emergency situations such that malfunctions would cause a significant risk to human life.

We are also amending 40 CFR 1036.601 to clarify that engines for emergency vehicles may need to include design features that don’t full comply with the OBD requirements in 40 CFR 1036.110. For example, the regulation requires in-cab displays with derate information for the driver, but the cab display should not include information about the schedule for pending derates an approved AEC will prevent that derate from occurring.

3. Updates to 40 CFR Part 1037 Heavy-Duty Motor Vehicle Provisions

i. Standards for Qualifying Small Businesses

As noted in section II.I, we are finalizing that qualifying small manufacturers will continue to be subject to the existing MY 2027 and later standards. We proposed revisions to 40 CFR 1037.150(c) that clarified the standards and proposed restrictions on participation in the ABT program for MYs 2027 and later for qualifying small manufacturers that utilize the interim provision. In the final rule, we have revised 40 CFR 1037.105(b) and (h) and 1037.106(b) to include the MY 2027 and later standards that apply for small manufacturers. The interim provisions of 40 CFR 1037.150(c) and (w) specify the flexibilities that continue to be available for small manufacturers. We are also finalizing as proposed the revised definition for “small manufacturer” in 40 CFR 1037.801.<sup>897</sup>

ii. Vehicles With Engines Using Fuels Other Than Carbon-Containing Fuels

In the HD2027 final rule, we adopted revisions to 40 CFR 1037.150(f) to include fuel cell electric vehicles, in addition to battery electric vehicles, in the provision that deems tailpipe emissions of regulated GHG pollutants as zero and as such does not require CO<sub>2</sub>-related emission testing. As discussed in section II.D.1, hydrogen-fueled internal combustion engines are a newer technology under development, and since hydrogen has no carbon, H<sub>2</sub> ICEs fueled with neat hydrogen produce zero HC, CH<sub>4</sub>, CO, and CO<sub>2</sub> engine-out emissions. We recognize that there may be negligible, but non-zero, CO<sub>2</sub> emissions at the tailpipe of H<sub>2</sub> ICE vehicles fueled with neat hydrogen that utilize SCR due to the aftertreatment system contribution from urea decomposition. Similarly, CO<sub>2</sub> emissions are attributable to the aftertreatment systems in ICE. These aftertreatment-based CO<sub>2</sub> emissions from HD CI engines today are treated differently in the engine and vehicle compliance programs. In the engine program, the CO<sub>2</sub> emissions from the aftertreatment are included in the measurements to demonstrate compliance with the engine CO<sub>2</sub> standards in 40 CFR part 1036. In the vehicle program, the CO<sub>2</sub> emissions from the aftertreatment are excluded

<sup>897</sup> The revision removes criteria for trailers and revenue that do not apply for the heavy-duty truck manufacturing category covered by this rule and adds a clarifying reference to what qualifies as an affiliated company for applying the specified number of employee limits.

from the fuel maps developed to demonstrate compliance with the vehicle CO<sub>2</sub> emission standards in 40 CFR part 1037. We are finalizing an approach to maintain common measurement of emissions from ICE regardless of the fuel used to power them. Therefore, we are finalizing as proposed to include vehicles using engines fueled with neat hydrogen in 40 CFR 1037.150(f) so that their CO<sub>2</sub> tailpipe emissions are deemed to be zero and manufacturers are not required to perform any engine testing for demonstrating compliance with the vehicle CO<sub>2</sub> emission standards. This final revision does not change the requirements for H<sub>2</sub> ICE engines, including those fueled with neat hydrogen, to meet the N<sub>2</sub>O GHG standards and the criteria pollutant emission standards in 40 CFR part 1036. Additionally, we are revising as proposed 40 CFR 1037.150(f) to replace “electric vehicles” with “battery electric vehicles”, and “hydrogen fuel cell vehicles” with “fuel cell electric vehicles”, consistent with final revisions to those definitions (see section I.C.3.xiii of this preamble).

iii. ABT Calculations

We proposed revisions to the definitions of two variables of the emission credit calculation for ABT in 40 CFR 1037.705. As noted in section II.C, we are not finalizing the proposed update to the emission standard variable (variable “Std”) to establish a common reference emission standard when calculating ABT emission credits for vocational vehicles with tailpipe CO<sub>2</sub> emissions deemed to be. However, we are finalizing as proposed a revision to the “Volume” variable. With the final revision to paragraph (c), we intend for 40 CFR 1037.705(c) to replace “U.S.-directed production volume” as the primary reference for the appropriate production volume to apply with respect to the ABT program and propose to generally replace throughout part 1037.

iv. U.S.-Directed Production Volume

The existing 40 CFR 1037.205, which describes requirements for the application for certification, uses the term U.S.-directed production volume. As described in section I.A.1, we are finalizing a change to the definition of “U.S.-directed production volume”, such that the term equates to nationwide production volumes that include any production volumes certified to different state standards. The revised definition does not require a change to 40 CFR 1037.205 to ensure

<sup>896</sup> See 40 CFR 1036.150(f).

manufacturers report nationwide production volumes.

We are finalizing as proposed revisions to the introductory paragraph of 40 CFR 1037.705(c), consistent with the final revisions to the corresponding HD engine provisions, to establish this paragraph as the reference for which engines are excluded from the production volume used to calculate emission credits for HD highway (see section I.C.2.v of this preamble). Similarly, final revisions include replacing several instances of “U.S.-directed production volume” with a more general “production volume” where the text clearly is connected to ABT or a more specific reference to the production volume specified in 40 CFR 1037.705(c).<sup>898</sup>

v. Revisions to Hybrid Powertrain Testing and Axle Efficiency Testing

We are finalizing the addition of a new figure to 40 CFR 1036.545 to give an overview on how to carry out hybrid powertrain testing in that section. We are finalizing in the axle efficiency test in 40 CFR 1037.560(e)(2) the use of an alternate lower gear oil temperature range on a test point by test point basis in addition to the current alternate that requires the use of the same lower temperature range for all test points within the test matrix. This provides more representative test results as not all test points within a matrix for a given axle test will result in gear oil temperatures within the same range. We are also finalizing a change to 40 CFR 1037.560(h)(1) to require that testing must be done using the same temperature range for each setpoint for all axle assemblies when developing analytically derive axle power loss maps for untested configurations within an axle family.

vi. Removal of Trailer Provisions

As part of the HD GHG Phase 2 rulemaking, we set standards for certain types of trailers used in combination with tractors (see 81 FR 73639, October 25, 2016). We are finalizing the removal of the regulatory provisions related to trailers in 40 CFR part 1037 to carry out a decision by the U.S. Court of Appeals for the D.C. Circuit, which vacated the portions of the HD GHG Phase 2 final rule that apply to trailers.<sup>899</sup> These revisions include removal of specific sections and paragraphs describing trailer provisions and related references throughout the part. Additionally, we

are finalizing new regulatory text for an existing test procedure that currently refers to a trailer test procedure. The existing 40 CFR 1037.527 describes a procedure for manufacturers to measure aerodynamic performance of their vocational vehicles by referring to the A to B testing methodology for trailers in 40 CFR 1037.525. We have removed the regulatory text describing A to B testing from the trailer procedure and moved it into 40 CFR 1037.527 (such that it replaces the cross-referencing regulatory text).

vii. Removal of 40 CFR 1037.205(q)

We have corrected an inadvertent error and have removed the existing 40 CFR 1037.205(q). This paragraph contained requirements we proposed in HD2027 but did not finalize and thus did not intend to include in the final rule’s amendatory instructions, regarding information for battery electric vehicles and fuel cell electric vehicles to show they meet the standards of 40 CFR part 1037.

viii. Adding Full Cylinder Deactivation to 40 CFR 1037.520(j)(1)

We are finalizing as proposed to credit vehicles with engines that include full cylinder deactivation during coasting at 1.5 percent. We believe this is appropriate since the same 1.5 percent credit is currently provided for tractors and vocational vehicles with neutral coasting, and both technologies reduce CO<sub>2</sub> emissions by reducing the engine braking during vehicle coasting.<sup>900</sup> Cylinder deactivation can reduce engine braking by closing both the intake and exhaust valves when there is no operator demand to reduce the pumping losses of the engine when motoring. Because of this, only vehicles with engines where both exhaust and intake valves are closed when the vehicle is coasting qualify for the 1.5 percent credit.

ix. Removal of Chassis Testing Option Under 40 CFR 1037.510 and Reference Update

We are removing the chassis dynamometer testing option for testing over the duty cycles as described in 40 CFR 1037.510(a). The chassis dynamometer test was available as an option for Phase 1 testing in 40 CFR 1037.615. We are removing it to avoid confusion as the chassis dynamometer testing option is only allowed when performing off-cycle testing following 40 CFR 1037.610 and is not allowed for

creating the cycle average fuel map for input into GEM. Note that manufacturers may continue to test vehicles on a chassis dynamometer to quantify off-cycle credits under 40 CFR 1037.610.

We are also correcting paragraph reference errors in 40 CFR 1037.510(a)(2)(iii) and (iv). These paragraphs reference the warmup procedure in 40 CFR 1036.520(c)(1). The warmup procedure is located in 40 CFR 1036.520(d).

x. Utility Factor Clarification for Testing Engines With a Hybrid Power Takeoff Shaft

We are clarifying the variable description for the utility factor fraction  $UF_{RCD}$  in 40 CFR 1037.540(f)(3)(ii). The current description references the use of an “approved utility factor curve”. The original intent was to use the power take off utility factors that reside in Appendix E to 40 CFR part 1036 to generate a utility factor curve to determine  $UF_{RCD}$ . We are clarifying this by replacing “approved utility factor curve” with a reference to the utility factors in Appendix E.

xi. Heavy-Duty Vehicles at or Below 14,000 Pounds GVWR

The final standards in this rule apply for all heavy-duty vehicles above 14,000 pounds GVWR, except as noted in existing 40 CFR 1037.150(l). We are not changing the option for manufacturers to voluntarily certify incomplete vehicles at or below 14,000 pounds GVWR to 40 CFR part 1037 instead of certifying under 40 CFR part 86, subpart S; the final standards in this rule would also apply for those incomplete heavy-duty vehicles. We are removing 40 CFR 1037.104 as proposed and refer manufacturers to 40 CFR 1037.5 for excluded vehicles.<sup>901</sup>

In a parallel rulemaking to set new emission standards for light-duty and medium-duty vehicles under 40 CFR part 86, subpart S, we proposed a requirement for complete and incomplete vehicles at or below 14,000 pounds GVWR with Gross Combined Weight Rating above 22,000 pounds to have installed engines that have been certified to the engine-based criteria emission standards in 40 CFR part 1036. Those vehicles would continue to meet GHG standards under 40 CFR 86.1819 instead of meeting the engine-based GHG standards in 40 CFR part 1036 and the vehicle-based GHG standards in 40 CFR part 1037, with one exception. The exception would be to allow an option

<sup>898</sup> See revisions in 40 CFR 1037.150(c) and 1037.730(b).

<sup>899</sup> Truck Trailer Manufacturers Association v. EPA, 17 F.4th 1198 (D.C. Cir. 2021).

<sup>900</sup> See the HD GHG Phase 2 rule (81 FR 73598, October 25, 2016), for more information on how 1.5 percent was determined for neutral coasting.

<sup>901</sup> This change includes removing the reference to 40 CFR 1037.104 in 40 CFR 1037.1.

for manufacturers of such incomplete vehicles to meet the greenhouse gas standards under 40 CFR parts 1036 and 1037 instead of meeting the chassis-based greenhouse gas standards under 40 CFR part 86, subpart S. In that parallel rulemaking, the final rule allows manufacturers the option to certify those engines to the engine-based criteria emission standards under 40 CFR part 1036 instead of certifying to chassis-based standards under 40 CFR part 86, subpart S. For manufacturers that select that option, the greenhouse gas standards apply as we just described for the proposed rule.

xii. Updates to Optional Standards for Tractors at or Above 120,000 Pounds

In HD GHG Phase 2 and in a subsequent rulemaking, we adopted optional heavy Class 8 tractor CO<sub>2</sub> emission standards for tractors with a GCWR above 120,000 pounds (see 40 CFR 1037.670).<sup>902</sup> We did this because most manufacturers tend to rely on U.S. certificates as their evidence of conformity for products sold into Canada to reduce compliance burden. Therefore, in Phase 2 we adopted provisions that allow the manufacturers the option to meet standards that reflect the appropriate technology improvements, along with the powertrain requirements that go along with higher GCWR. While these heavy Class 8 tractor standards are optional for tractors sold into the U.S. market, Canada adopted these as mandatory requirements as part of their regulatory development and consultation process. As proposed, we are adopting provisions to sunset the optional standards after MY 2026.<sup>903</sup>

xiii. Updates to 40 CFR Part 1037 Definitions

We are finalizing several updates to the definitions in 40 CFR 1037.801. As noted in section I.C.3.vi, we are removing the trailer provisions, which include removing the following definitions: Box van, container chassis, flatbed trailer, standard tractor, and tank trailer. We also are revising several definitions to remove references to trailers or trailer-specific sections, including definitions for: Class, heavy-duty vehicle, low rolling resistance tire, manufacturer, model year, Phase 1, Phase 2, preliminary approval, small

manufacturer, standard payload, tire rolling resistance, trailer, and vehicle.

We are finalizing new and updated definitions in support of several requirements in section II or this section III. We are finalizing replacement of the existing definition of “electric vehicle” with more specific definitions for the different vehicle technologies and energy sources that could be used to power these vehicles. Specifically, we are finalizing new definitions for battery electric vehicle, fuel cell electric vehicle, and plug-in hybrid electric vehicle. We are also finalizing the replacement of the existing definition of “hybrid engine or hybrid powertrain” with a definition of “hybrid” that refers to a revised definition in 40 CFR part 1036.<sup>904</sup> We are also updating the definition of U.S.-directed production volume to be equivalent to nationwide production as described section III.A.1.

We are finalizing several editorial revisions to definitions as well. We are finalizing a revision to the definition of vehicle to remove the text of existing paragraph (2)(iii) and move the main phrase of that removed paragraph (*i.e.*, “when it is first sold as a vehicle”) to the description of “complete vehicle” to further clarify that aspect of the existing definition. We are finalizing as proposed a revision to the existing definition of small manufacturer, in addition to the revisions removing reference to trailers, to clarify that the employee and revenue limits include the totals from *all* affiliated companies and added a reference to the definition of affiliated companies in 40 CFR 1068.30.

We are finalizing revisions to the definitions of “light-duty truck” and “light-duty vehicle”, by having the definitions reference the definitions in 40 CFR 86.1803–1.

xiv. Miscellaneous Corrections and Clarifications in 40 CFR Part 1037

We are finalizing revisions to several references to 40 CFR part 86 revisions. Throughout 40 CFR part 1037, we are replacing references to 40 CFR 86.1816 or 86.1819 with a more general reference to the standards of part 86, subpart S. These revisions reduce the need to update references to specific part 86 sections if new standards are added to a different section in a future rule. We are not revising any references to specific part 86 paragraphs (*e.g.*, 40 CFR 86.1819–14(j)).

We are removing the duplicative statements in 40 CFR 1037.105(c) and 1037.106(c) regarding CH<sub>4</sub> and N<sub>2</sub>O

standards from their current locations and moving it to 40 CFR 1037.101(a)(2)(i) where we currently describe the standards that apply in part 1037. We are also updating 40 CFR 1037.101(a)(2)(i) to more accurately state that only CO<sub>2</sub> standards are described in 40 CFR 1037.105 and 1037.106, by removing reference to CH<sub>4</sub> and N<sub>2</sub>O in that sentence. We are updating the section title for 40 CFR 1037.102 to include the term “Criteria” and the list of components (*i.e.*, NO<sub>x</sub>, HC, PM, and CO) covered by the section to be consistent with the naming convention used in 40 CFR part 1036.

xv. Finalized Changes for In-Use Tractor Testing in 40 CFR 1037.665

The in-use tractor testing requirements were adopted to apply only to Phase 1 and Phase 2 tractors. We proposed to extend that to Phase 3 tractors as well, but received comments describing the significant test burden and limited value in performing this testing. Based on those comments and our own evaluation of the merits of further testing, we are not taking final action on the proposed change to extend testing requirements to Phase 3 tractors.

xvi. Finalized Changes to Constraints for Vocational Regulatory Subcategories in 40 CFR 1037.150(v)

In this action we are finalizing clarifications to 40 CFR 1037.150(z).<sup>905</sup> As pointed out in comments to this rule, 40 CFR 1037.150(z) included provisions that were duplicative, potentially confusing, or not needed. To address these concerns, we are deleting the former paragraph (z)(1), which contains a requirement to select the Regional regulatory subcategory if the engine is only tested with the Supplemental Emission Test. This scenario, however, is not allowed, as 40 CFR 1036.108(a)(1) requires that vocational engines measure CO<sub>2</sub> emissions over the FTP duty cycle. We are also deleting the reference to former paragraphs (z)(1) and (3) in the former paragraph (z)(5), as we are removing paragraphs (z)(1) and the former paragraph (z)(3) provides restrictions for defining vehicles as Urban and is not applicable to defining vehicles to the Multi-purpose regulatory subcategory. Finally, we are deleting former paragraph (z)(6), as it is identical to former paragraph (z)(5).

4. Updates to 40 CFR Part 1039 Nonroad Compression-Ignition Engines

The final rule includes an amendment to 40 CFR 1039.705(b) to correct a

<sup>902</sup> 81 FR 73582 (October 25, 2016) and 86 FR 34338 (June 29, 2021).

<sup>903</sup> We removed the standards listed in the rightmost column of existing table 1 of paragraph (a) of § 1037.670; we note that the column was intended for model years 2027 and later standards but was mistakenly labeled “Model years 2026 and later”.

<sup>904</sup> See section I.C.2.xiii of this preamble for a description of the updated definition of hybrid.

<sup>905</sup> Note that 40 CFR 1037.150(z) is being moved to 40 CFR 1037.150(v).

publishing error in the equation to calculate emission credits for nonroad compression-ignition engines.

5. Updates to 40 CFR Part 1065 Engine Testing Procedures

i. Engine Testing and Certification With Fuels Other Than Carbon-Containing Fuels

Alternative fuels and fuels other than carbon-containing fuels are part of the fuel pathway for sustainable biofuel, e-fuel, and clean hydrogen development under the U.S. National Blueprint for Transportation Decarbonization.<sup>906</sup> This blueprint anticipates a mix of battery electric, sustainable fuel, and hydrogen use to achieve a net zero carbon emissions level by 2050 for the heavy-duty sector. EPA is updating 40 CFR part 1065 to facilitate certification of engines using fuels other than carbon-containing fuels for all sectors that use engine testing to show compliance with the standards. This includes a new definition of “carbon-containing fuel” in 40 CFR 1065.1001, the addition of a new paragraph (f) in 40 CFR 1065.520 that requires the selection of the chemical balance method prior to emission testing, and the addition of a new chemical balance procedure in section 40 CFR 1065.656 that is used in place of the carbon-based chemical balance procedure in 40 CFR 1065.655 when an engine is certified for operation using fuels other than carbon-containing fuels (e.g., hydrogen or ammonia).<sup>907</sup> Since these fuels do not contain carbon, the current carbon-based chemical balance cannot be used as it is designed based on comparisons of the amount of carbon in the fuel to the amount measured post combustion in the exhaust. The chemical balance for fuels other than carbon-containing fuels looks at the amount of hydrogen in the fuel versus what is measured in the exhaust. The amendments also facilitate certification of an engine on a mix of carbon-containing fuels and fuels other than carbon-containing fuels. The update to 40 CFR 1065.520(f) also requires the decision on which chemical balance to use to be based on the hydrogen-to-carbon ratio of the fuel mixture. If it is less or equal to 6, the chemical balance in 40 CFR 1065.655 must be used. The regulation at 40 CFR 1065.695, Data Requirements, was also

updated with the addition of a new paragraph (c)(9)(v) to add a requirement to in the section that describes the emission calculations used, including listing the chemical balance method used.

The addition of the certification option for fuels other than carbon-containing fuels relies on inputs requiring hydrogen, ammonia, and water concentration measurement from the exhaust. We are finalizing the addition of new sections in 40 CFR part 1065 and revisions to some existing sections to support the procedure in 40 CFR 1065.656. We are finalizing a new 40 CFR 1065.255 to provide specifications for hydrogen measurement devices, a new 40 CFR 1065.257 to provide specifications for water measurement using a Fourier Transform Infrared (FTIR) analyzer, and a new 40 CFR 1065.277 to provide specifications for ammonia measurement devices. These additions also require a new 40 CFR 1065.357 to address CO<sub>2</sub> interference when measuring water using an FTIR analyzer, a new 40 CFR 1065.377 to address H<sub>2</sub>O interference and any other interference species as deemed by the instrument manufacturer or using good engineering judgment when measuring NH<sub>3</sub> using an FTIR or laser infrared analyzers, and the addition of calibration gases for these new analyzer types to 40 CFR 1065.750. We are also adding drift check requirements to 40 CFR 1065.550(b) to address drift correction of the H<sub>2</sub>, O<sub>2</sub>, H<sub>2</sub>O, and NH<sub>3</sub> measurements needed in the 40 CFR 1065.656 procedure. We are not finalizing the addition of drift check requirements for H<sub>2</sub>, O<sub>2</sub>, H<sub>2</sub>O, and NH<sub>3</sub> measurements in 40 CFR 1065.935(g)(5)(ii) for testing with PEMS. These exhaust gas constituents are not regulated and are used in the chemical balance to facilitate dilution ratio determination for background correction and dry to wet correction. If there is any significant drift with these species, the impact will be included in the drift check verification of the regulated pollutants. We are also adding a new 40 CFR 1065.750(a)(6) to address the uncertainty of the water concentrations generated to perform the linearity verification of the water FTIR analyzer in 40 CFR 1065.257. We are finalizing two options to generate a humid gas stream. The first is via a heated bubbler where dry gas is passed through the bubbler at a controlled water temperature to generate a gas with the desired water content. The second is a device that injects heated liquid water into a gas stream. The linearity

verification requirement for the humidity generator is once a year to an uncertainty of ±3 percent;<sup>908</sup> however, we are not requiring that the calibration of the humidity generator be NIST traceable. We are finalizing a leak check requirement after the humidity generator is assembled, as these devices are typically disassembled and stored when not in use and subsequent assembly prior to use could lead to leaks in the system. We are including calculations to determine the uncertainty of the humidity generator from measurements of dewpoint and absolute pressure. We are finalizing a new definition for “carbon-containing fuel” and “lean-burn” in 40 CFR 1065.1001 to further support the addition of the certification option for engines using fuels other than carbon-containing fuels.

We are not adding any specifications for alternative test fuels, like methanol, and fuels other than carbon-containing fuels like hydrogen and ammonia, to 40 CFR part 1065, subpart H. Manufacturers certifying engines with alternative test fuels must use the provision in 40 CFR 1065.701(c) which allows the use of test fuels that we do not specify in 40 CFR part 1065, subpart H, with our approval.

ii. Engine Speed Derate for Exhaust Flow Limitation

We are finalizing a change to 40 CFR 1065.512(b)(1) to address the appearance of three options for generating new reference duty-cycle points for the engine to follow. The option in the existing 40 CFR 1065.512(b)(1)(i) is not an actual option; instead, it gives direction on how to operate the dynamometer (torque control mode). This sentence has been moved into 40 CFR 1065.512(b)(1). The two remaining options in the current 40 CFR 1065.512(b)(1)(ii) and (iii) have been redesignated as 40 CFR 1065.512(b)(1)(i) and (ii).

We are not finalizing the change we proposed to 40 CFR 1065.512(b)(1) to address cycle validation issues where an engine with power derate intended to limit exhaust mass flowrate might include controls that reduce engine speed under cold-start conditions, resulting in reduced exhaust flow that assists other aftertreatment thermal management technologies (e.g., electric heater). Upon further investigation of the test procedure, we determined that 40 CFR part 1065 already contains

<sup>906</sup> The U.S. National Blueprint for Transportation Decarbonization: A Joint Strategy to Transform Transportation. DOE/EE-2674. January 2023. Available at: <https://www.energy.gov/sites/default/files/2023-01/the-us-national-blueprint-for-transportation-decarbonization.pdf>.

<sup>907</sup> We are also finalizing a definition for “carbon-containing fuel” in 40 CFR 1036.801 that references the proposed new 40 CFR part 1065 definition.

<sup>908</sup> The verification schedule in 40 CFR 1065.750(a)(6) says: “Calibrate the humidity generator upon initial installation, within 370 days before verifying the H<sub>2</sub>O measurement of the FTIR, and after major maintenance.”.

options to address this. If the engine has the power derate feature described previously in this section, when this feature is active, the following scenarios would be applicable to enable engine testing:

1. For idle points:
  - a. For engines with an idle governor, have the dynamometer control torque and set the operator demand to minimum (same as what is currently done for most engine tests).
  - b. For engines without an idle governor (*i.e.*, no possibility of an enhanced or decreased idle governor speed), the test lab can decide whether to control speed or torque with the dyno and operator demand.
2. For non-idle-non-motoring points, have the dynamometer control torque and the operator demand control speed.
3. For motoring points, have the dynamometer control speed and set operator demand to minimum (same as what is currently done for most engine tests).

If a test lab tested an engine with power derate and took this approach and the power derate feature activates, we would expect the following to occur:

- For idle points under option 1a of the list, this feature could lower the idle governor setpoint and the dynamometer would continue to apply the reference idle torque. Presumably, any fueling limit at idle would be sufficient to keep the engine from stalling in-use and it would not stall in the test cell under this idle condition.
- For idle points under option 1b of the list, on engines without an idle governor (if this case is even practical for this technology), the fueling limit still cannot be set so low as to cause the engine to stall under idle load conditions.
- For non-idle-non-motoring points (option 2 of the list), the throttle is expected to saturate at maximum and the dynamometer will continue to try to apply the reference torque. This operation has the possibility of stalling the engine if the fueling limit is insufficient to produce the reference torque at a reduced speed and might require a stall countermeasure in the test cell controls.
- For motoring points (option 3 of the list), it is assumed the engine is already at minimum fueling (because the operator demand is at minimum) and power derate feature will have no impact on these points.

### iii. Accelerated Aftertreatment Aging

We recently finalized a new accelerated aftertreatment aging procedure for use in deterioration factor determination in 40 CFR 1065.1131

through 1065.1145. We requested comment on the need for potential changes to the procedure based on experience that manufacturers and test labs have gained since the procedure was finalized.

We are finalizing changes to 40 CFR 1065.1135, 1065.1137, 1065.1139, 1065.1141, and 1065.1145. These changes are based on EPA's consideration of comments submitted to EMA's Emission Measurement and Testing Committee (EMTC). The comments consisted of a series of updates to the affected sections listed. These updates were based on additional testing and accelerated aging model validation performed by Southwest Research Institute as part of the Diesel Aftertreatment Accelerated Aging Cycle (DAAAC) Validation Steering Committee that consists of government (EPA) and industry (EMA) representatives who were part of the original DAAAC validation study that procedures in 40 CFR 1065.1131 through 1065.1145 were based on.

Explanation of the changes to the sections listed are as follows:

- We are finalizing an editorial change to 40 CFR 1065.1135 that is the simple insertion of a comma.
- We are finalizing non-substantive wording changes to 40 CFR 1065.1137.
- We are finalizing a change to 40 CFR 1065.1137(b)(1) where we are adding "storage capacity of the more active site" as an additional recommended metric for determining the thermal reactivity coefficient for use in the Arrhenius rate law function to model cumulative thermal degradation due to catalyst heat exposure for copper-based zeolite SCR catalysts. This metric has been shown to be an effective metric for tracking thermal aging in addition to the already allowed ratio between the storage capacity of the two different storage sites.
- We are finalizing a change to 40 CFR 1065.1137(b)(2) where we are removing the 250 °C temperature target for the single storage site thermal aging metric for iron-based zeolite SCR catalysts. Advancements in this catalyst technology have led to the need for a technology formulation specific temperature as opposed to the use of a prescribed default temperature, which we are adding as part of this change.
- We are finalizing a change to 40 CFR 1065.1137(b)(3) where we are removing the use of NO<sub>x</sub> conversion at 250 °C temperature target for the single storage site thermal aging metric for vanadium SCR catalysts. Advancements in this catalyst technology have led to the need for a different approach for tracking aging to achieve sufficient

resolution. We are updating the key aging metric to Brunauer–Emmett–Teller (BET) theory for determination of surface area. We are also allowing the use of total ammonia storage capacity as a surrogate for BET measurements of surface area as the key aging metric, using a single storage site model.

- We are finalizing the addition of a new 40 CFR 1065.1137(b)(4) to add total ammonia storage capacity as a recommended key aging metric for zone-coated copper- and iron-based zeolite SCR, similar to paragraphs (b)(1) and (2) of the section. There was no option given previously for determining the key aging metric for this technology and the new addition remedies this.

- We are finalizing a change to the redesignated 40 CFR 1065.1137(b)(5) to the key aging metric NO to NO<sub>2</sub> conversion rate and HC reduction efficiency temperatures to a value less than or equal to 200 °C determined using good engineering judgement. This change resolves the inconsistencies throughout 40 CFR part 1037 regarding the temperature rate at which the conversion rate should be determined.

- We are finalizing an update to 40 CFR 1065.1137(c)(1) to change the recommended maximum time to observe changes in the aging metric from 50 hours to 64 hours as 64 hours is more in line with the pattern of increasing evenly spaced time intervals (2, 4, 8, 16, and 32 hours) given in 40 CFR 1065.1137(c)(2).

- We are finalizing the addition of new paragraphs (c)(2)(i) and (ii) to 40 CFR 1065.1137 to add processes for determining ammonia storage capacity for SCR catalysts as well as for determining oxidation conversion efficiency of NO to NO<sub>2</sub> for diesel oxidation catalysts (DOC) to assess the aging metric. These are the standard methodologies for assessing the aging metric and will provide a level playing field for test facilities carrying out accelerated aging testing.

- We are finalizing updates to 40 CFR 1065.1137, specifically new paragraphs (d)(1) through (4) to replace the use of a generalized deactivation equation for determination of catalyst deactivation rate constant,  $k_D$ , and thermal reactivity coefficient,  $E_{a,D}$ . The generalized equation was replaced with more specific processes for copper-based zeolite SCR (40 CFR 1065.1137(d)(1)), iron-based zeolite and vanadium SCR (40 CFR 1065.1137(d)(2)), zone-coated zeolite SCR (40 CFR 1065.1137(d)(3)), and diesel oxidation catalysts (40 CFR 1065.1137(d)(4)). These updates stem from the need for more detail and specificity on how to model the thermal reactivity coefficient to provide

consistency and a level playing field. For example, it provides a means to use the temperature programmed desorption (TPD) data used to generate the ammonia storage capacity values to model catalyst deactivation.

- 40 CFR 1065.1137(d)(1) for copper-based zeolite SCR requires the processing of all ammonia TPD data for each aging condition using an algorithm to fit the ammonia desorption data. We recommend using a Temkin adsorption model to quantify the ammonia TPD at each site to determine the desorption peaks of individual storage sites. We allow either the general power law expression (GPLe) or Arrhenius modeling approaches to derive the thermal reactivity coefficient,  $E_{a,D}$ . We recommend that both models are used to fit the data and that the resulting  $E_{a,D}$  values for the two methods are within 3 percent of each other as a quality assurance check. These updates stem from the need for more detail and specificity on how to model the thermal reactivity coefficient to provide consistency and a level playing field.

- 40 CFR 1065.1137(d)(2) for iron-based zeolite of vanadium SCR requires the processing of all ammonia TPD data (or BET surface area data) for each aging condition using GLPE to fit the ammonia desorption data. Global fitting is used to solve for  $E_{a,D}$  and the pre-exponential factor,  $A_D$ , by applying a generalized reduced gradient (GRG) nonlinear minimization algorithm. These updates stem from the need for more detail and specificity on how to model the thermal reactivity coefficient to provide consistency and a level playing field.

- 40 CFR 1065.1137(d)(3) for zone-coated zeolite SCR requires derivation of the thermal reactivity coefficient,  $E_{a,D}$ , for each zone of the SCR, based on 40 CFR 1065.1137(d)(1) and (2). The zone that yields the lowest  $E_{a,D}$  is used for calculating the target cumulative thermal load, as outlined in 40 CFR 1065.1139. These updates stem from the need for more detail and specificity on how to model the thermal reactivity coefficient to provide consistency and a level playing field.

- 40 CFR 1065.1137(d)(4) for diesel oxidation catalysts models the catalyst monolith as a plug flow reactor with first order reaction rate. The pre-exponential term,  $A$ , in the Arrhenius rate law function is proportional to the number of active sites and is the desired aging metric. The NO to NO<sub>2</sub> oxidation reverse light off data for each aging condition is processed by determining the average oxidation conversion efficiency at a temperature of less than or equal to 200 °C determined using

good engineering judgement and this is used to calculate the aging metric. This temperature limit change resolves the inconsistencies throughout 40 CFR part 1037 regarding the temperature rate at which the conversion rate should be determined. GPLe is used to fit the NO to NO<sub>2</sub> conversion data at each aging temperature. Global fitting is used to solve for  $E_{a,D}$  and the pre-exponential factor,  $A_D$ , by applying a generalized reduced gradient (GRG) nonlinear minimization algorithm. These updates stem from the need for more detail and specificity on how to model the thermal reactivity coefficient to provide consistency and a level playing field.

- We are finalizing the addition of new paragraphs 40 CFR 1065.1139(e)(6)(v) for heat load calculation and tuning for systems that have regeneration events and 40 CFR 1065.1139(f)(3) for heat load calculation and tuning for systems that do not have regeneration events. These additions allows a reduction in the acceleration factor from 10 to a lower number if the target cumulative deactivation for the field data,  $D_{t,field}$ , is not achievable without exceeding the catalyst temperature limits. This would be applicable, for example, for a vanadium catalyst where you might not be able to age at the target temperature because it might cause vanadium sublimation, thus you would use a lower target temperature and then increase the test time to arrive at equivalent aging. The same lower acceleration factor for thermal aging must also then be used in the chemical exposure calculations, instead of 10.

- We are finalizing the addition of a new 40 CFR 1065.1141(b)(2) to add an additional method recommendation on modification of the engine to increase oil consumption to levels required for accelerated aging in a manner such that the oil consumption is still generally representative of oil passing the piston rings into the cylinder. This method uses iterative modification of the oil control rings in one or more cylinders to reduce the spring tension on the oil control ring and provides a robust means to increase engine oil consumption.

- We are finalizing an update to 40 CFR 1065.1141(f) to recommend incorporation of a method of continuous oil consumption monitoring during accelerated aging, including validation of the monitoring method with periodic draining and weighing of the engine oil. This is to ensure that oil consumption rates are representative over the course of the accelerated aging test.

- We are finalizing an update to 40 CFR 1065.1145(d) to recommended that

if the aging cycle is paused for any reason, you resume testing at the same point in the cycle where it stopped to ensure consistent thermal and chemical exposure of the aftertreatment system.

- We are finalizing an update to 40 CFR 1065.1145(e)(2)(i) to remove the requirement to operate the engine for at least 4 hours after an oil change with the exhaust bypassing the aftertreatment system to stabilize the new oil. The Southwest Research Institute Diesel Aftertreatment Accelerated Aging Cycle (DAAAC) Validation test program did not stabilize new oil after an oil change and the validation program results to date indicate that there is no adverse effect on accelerated aging. Therefore we are removing the break in requirement to reduce test burden.

#### iv. Nonmethane Cutter Water Interference Correction

We recently finalized options and requirements for gaseous fueled engines to allow a correction for the effect of water on the nonmethane cutter (NMC) performance, as gaseous fueled engines produce much higher water content in the exhaust than gasoline or diesel fuels, impacting the final measured emission result.<sup>909</sup> The correction is done by adjusting the methane and ethane response factors used for the Total Hydrocarbon (THC) Flame Ionization Detector (FID) and the combine methane response factor and penetration fraction and combined ethane response factor and penetration fraction of the NMC FID. These response factors and penetration fractions are then used to determine NMHC and methane concentrations based on the molar water concentration in the raw or diluted exhaust. EPA is aware that test labs that have attempted to implement this correction have reported that this new option is lacking clarity with respect to the implementation of these corrections from both a procedural and emission calculation perspective. Test labs and manufacturers have also requested the option to use the water correction for all fuels, not just gaseous fuels. Test labs and manufacturers have also stated that in their view, as written, 40 CFR 1065.360(d)(12) indicates that the water correction for the methane response factor on the THC FID is required; we note that was not our intent and are finalizing updates to this section to clarify that provision.

In addition to general edits that improve the consistency of terminology and the rearrangement of some paragraphs to improve the flow of the procedure, we are making the following

<sup>909</sup> 86 FR 34543, June 29, 2021.

changes to 40 CFR 1065.360, 1065.365, and 1065.660 to address the concerns raised regarding implementation and use of the NMC performance corrections. In 40 CFR 1065.360 and 1065.365, we are allowing the optional use of the water correction for the applicable response factors and penetration fractions for engines operated on any fuel, as the use of the correction improves the quality of the emission measurement even though the effect is less pronounced for liquid fuels. In 40 CFR 1065.360, we are finalizing revisions to clarify that determination of the FID methane response factor as a function of molar water concentration is optional for all fuels. In 40 CFR 1065.365, we are removing the recommendation of a methane penetration fraction of greater than 0.85 for the NMC FID because the procedure will account for the effect of the penetration fraction regardless of the level of NMC methane penetration. We are also finalizing a corresponding change in relation to another change in this rule, such that the requirements for linearity performance of the humidity generator must meet the uncertainty requirements in 40 CFR 1065.750(a)(6) that we have added to address the accuracy of humidity generators used in the calibration of the FTIRs used for water measurement. In 40 CFR 1065.660, we are modifying equations 1065.660–2 and 1065.660–9 by adding the variable for the methane response factor and penetration fraction for the NMC FID back into the equations, which we previously removed for simplification because the value was set to a constant of one. This modification has no effect on the outcome of the calculations if the effect of water on the NMC performance is not being accounted for because the procedure directs that the methane response factor and penetration fraction for the NMC FID are set to one. If the effect of water is being accounted for, these modified equations make it easier to understand the requirements of the procedure.

v. ISO 8178 Exceptions in 40 CFR 1065.601

Paragraph (c)(1) of 40 CFR 1065.601 allows the use of ISO 8178 mass-based emission calculations instead of the calculations specified in 40 CFR part 1065, subpart G, with two exceptions. We are updating the section reference to the exception in 40 CFR 1065.601(c)(1)(i) for NO<sub>x</sub> humidity and temperature correction from ISO 8178–1 Section 14.4 to ISO 8178–4 Section 9.1.6 to address updates made to ISO 8178 over the last 20 years that changed the location of this correction. We are

also removing the exception for the use of the particulate correction factor for humidity in ISO 8178–1 Section 15.1 because this correction factor no longer exists in ISO 8178.

vi. Work System Boundary in 40 CFR 1065.210

Figure 1 to paragraph (a) of 40 CFR 1065.210 provides diagrams for the work inputs, outputs, and system boundaries for engines. We are updating the diagram for liquid cooled engines in figure 1 to paragraph (a) of 40 CFR 1065.210 to include electric heaters that use work from an external power source. We are also updating 40 CFR 1065.210(a) to include an example of an engine exhaust electrical heater and direction on how to simulate the efficiency of the electrical generator, to account for the work of the electrical heater. We are finalizing an efficiency of 67 percent, as this is the value used in 40 CFR 86.1869–12(b)(4)(xiii) as the baseline alternator efficiency when determining off-cycle improvements of high efficiency alternators.

vii. Fuel and Diesel Exhaust Fluid Composition in 40 CFR 1065.655

We are finalizing updates to the elemental mass fraction variables in 40 CFR 1065.655(e) to clarify that these are measured values that are used to calculate the elemental ratios in the fuel mixture. Not the default values from table 2 of 40 CFR 1065.655. We are also finalizing updates to the variable description for carbon mass fraction for equation 1065.655–25 in 40 CFR 1065.655(f)(3). This update clarifies that the carbon mass fraction used in the equation is the one determined in 40 CFR 1065.655(d).

viii. NO<sub>2</sub>-to-NO Converter Conversion Verification in 40 CFR 1065.378

We are finalizing an update to the NO<sub>x</sub> converter efficiency check in 40 CFR 1065.378, adding an exception as a new paragraph (e)(3) to address instances where the peak total NO<sub>2</sub> concentration expected during the emission test will be high and the ozonator used in the converter efficiency check cannot generate enough NO<sub>2</sub> to approximate this level. With this change, a lab may request EPA approval to use an NO<sub>2</sub> gas in lieu of generating NO<sub>2</sub> from NO gas using an ozonator.

High peak total NO<sub>2</sub> emission concentrations could occur when performing OBD system certification where, for example, a manufacturer could be testing failed components that result in high NO<sub>2</sub> to NO<sub>x</sub> ratio with high total NO<sub>x</sub> (around 2000 ppm) or when measuring NO<sub>x</sub> from raw exhaust

where a high NO<sub>2</sub> spike might occur. Ozonators in chemiluminescent analyzers are generally not designed to generate that high of an NO<sub>2</sub> concentration during the NO<sub>x</sub> efficiency test (the step in § 1065.378(d)(3)(iv)). The update to 40 CFR part 1065 to allow the use of a high concentration NO<sub>2</sub> gas will alleviate these concerns.

ix. Formaldehyde Gas Blend Accuracy in 40 CFR 1065.750

We are finalizing the removal of formaldehyde from the gas mixture in 40 CFR 1065.750(a)(3)(xiii). There is no standard for formaldehyde from NIST and the preference is to gravimetrically blend it under the “other similar standards” provision in 40 CFR 1065.750(a)(4). Removing formaldehyde here increases the allowable blend tolerance from ±1 percent to ±3 percent of the NIST accepted value in addition to allowing the use of “other similar standards”, as this gas standard now must meet the requirements of 40 CFR 1065.750(a)(4). Formaldehyde did not appear on its own in 40 CFR 1065.750(a)(3), but rather as part of a gas mixture of 11 gasses in 40 CFR 1065.750(a)(3)(xiii). The gas blend in 40 CFR 1065.750(a)(3)(xiii) is for calibration of an FTIR when the FTIR additive method is used for determination of NMHC from gaseous fueled engines. Formaldehyde in an individual gas blend is already covered by 40 CFR 1065.750(a)(4). The removal of formaldehyde from the gas blend in 40 CFR 1065.750(a)(3)(xiii) now allows it to be blended based on the provisions in 40 CFR 1065.750(a)(4) and it can still be included in the gas mixture in 40 CFR 1065.750(a)(3)(xiii) for calibration of the FTIR.

x. Drift Validation of Emissions in 40 CFR 1065.672

We are finalizing an update to 40 CFR 1065.672(c) to delete occurrences of “brake-specific” as it relates to emission calculations for drift validation. Paragraph (c) currently references brake-specific emission calculations in 40 CFR 1065.650. 40 CFR 1065.650 includes calculations of mass emissions in addition to brake-specific emissions. Off-cycle emission testing requires calculation Bin 1 emissions rates that are in mass per unit time. This change will make the use of 40 CFR 1065.672 more universal and apply to mass emission rates and not just brake-specific emission rates.

**IV. Program Costs**

In this section, we present the costs we estimate will be incurred by manufacturers and purchasers of HD

vehicles impacted by the final standards. We also present the social costs of the final standards. Our analyses characterize the costs of the potential compliance pathway's technology packages described in section II.F of the preamble; however, as we note there, manufacturers may elect to comply using a different combination of HD vehicle and engine technologies than what we have modeled. We present these costs not only in terms of the upfront incremental technology cost differences between an HD BEV or FCEV powertrain and a comparable HD ICE powertrain,<sup>910</sup> but also how those costs will change in years following implementation due to learning-by-doing effects. These technology costs are presented in terms of direct manufacturing costs (DMC) and associated indirect costs. These direct and indirect costs when summed and multiplied by vehicle sales are referred to as "technology package costs" in this section, and when estimated relative to the reference case<sup>911</sup> represent the estimated costs incurred by manufacturers (*i.e.*, regulated entities) to comply with the final standards should a manufacturer choose to comply using the compliance pathway EPA modeled as one means of showing the standards' feasibility.

More specifically, we break the costs into the following categories and subcategories:

1. Technology Package Costs, which are the sum of DMC and indirect costs. This may also be called the package retail price equivalent (package RPE). This includes:

a. DMC, which include the costs of materials and labor to produce a product or piece of technology.

b. Indirect costs, which include research and development (R&D), warranty, corporate operations (such as salaries, pensions, health care costs, dealer support, and marketing), and profits.<sup>912</sup> We estimate indirect costs using RPE markups.

<sup>910</sup> Baseline vehicles are ICE vehicles meeting the previous MY 2027 Phase 2 standards discussed in RIA Chapter 2.2.2 and the HD2027 Low NO<sub>x</sub> standards discussed in RIA Chapter 2.3.2.

<sup>911</sup> As discussed in RIA Chapter 4.2.2, the reference case or scenario is a no-action scenario that represents emissions in the U.S. without the final rulemaking. Note, reference case cost estimates also include costs associated with replacing a comparable ICE powertrain baseline vehicle with a BEV or FCEV powertrain for ZEV adoption rates in the reference case.

<sup>912</sup> Technology costs represent costs that manufacturers are expected to attempt to recapture via new vehicle sales. As such, profits are included in the indirect cost calculation. Clearly, profits are not a "cost" of compliance—EPA is not imposing new regulations to force manufacturers to make a profit. However, profits are necessary for

2. Manufacturer Costs, or "manufacturer RPE," which is the package RPE less any applicable battery tax credits. This includes:

a. Package RPE. Traditionally, the package RPE is the manufacturer RPE in EPA cost analyses for HD standards.

b. Battery tax credit from IRA section 13502, "Advanced Manufacturing Production Credit," which serves to reduce manufacturer costs. The battery tax credit is described further in sections ES and II of this preamble and Chapters 1 and 2 of the RIA.

3. Purchaser Costs, which are the sum of purchaser (1) upfront costs (which include the upfront vehicle costs (manufacturer (also referred to as purchaser) RPE plus applicable Federal excise and state sales taxes less any applicable vehicle tax credit) plus applicable EVSE costs), and (2) operating costs. This includes:

a. Manufacturer RPE. In other words, the purchaser incurs the manufacturer's package costs less any applicable battery tax credits. We refer to this as the "manufacturer RPE" in relation to the manufacturer and, at times, the "purchaser RPE" in relation to the purchaser. These two terms are equivalent in this analysis.

b. Vehicle tax credit from IRA section 13403, "Qualified Commercial Clean Vehicles," which serve to reduce purchaser costs. The vehicle tax credit is described further in sections I and II of this preamble and Chapters 1 and 2 of the RIA.

c. Electric Vehicle Supply Equipment (EVSE) costs, which are the costs associated with charging equipment installed at depots. Our EVSE cost estimates include indirect costs so are sometimes referred to as "EVSE RPE."

d. EVSE tax credit from IRA section 13404, "Alternative Fuel Refueling Property Credit," which serve to reduce purchaser costs. The EVSE tax credit is described further in sections I and II of this preamble and Chapters 1 and 2 of the RIA.

e. Federal excise tax and state sales tax, which are upfront costs incurred for select vehicles for excise tax and for all heavy-duty vehicles for sales tax.

f. Purchaser upfront vehicle costs, which include the manufacturer (also referred to as purchaser) RPE plus EVSE costs plus applicable Federal excise and state sales taxes less any applicable vehicle tax credits.

manufacturers in the heavy-duty industry, a competitive for-profit industry, to sustain their operations. As such, manufacturers are expected to make a profit on the compliant vehicles they sell, and we therefore include those profits in estimating technology costs.

g. Operating costs, which include fuel costs (including costs for diesel, gasoline, CNG, electricity [which varies depending on whether the vehicle is charged at a depot or at a public charging facility], and hydrogen), costs for diesel exhaust fluid (DEF), maintenance and repair costs, insurance, battery replacement costs, ICE vehicle engine rebuild costs, and EVSE replacement costs.

4. Social Costs, which are the sum of package RPE, EVSE RPE, and operating costs and computed on at a fleet level on an annual basis. Note that fuel taxes, Federal excise tax, state sales tax and battery, vehicle and EVSE tax credits are not included in the social costs. Taxes, registration fees, and tax credits are transfers as opposed to social costs. Social costs include:

a. Package RPE (which excludes applicable tax credits).

b. EVSE RPE (which excludes applicable tax credits).

c. Operating costs which include pre-tax fuel costs, electricity costs (including those associated with electrification infrastructure and a public charging network), DEF costs, insurance, maintenance and repair costs, battery replacement costs, ICE vehicle engine rebuild costs, and EVSE replacement costs.

We describe these costs and present our cost estimates in the text that follows, after we discuss the relevant IRA tax credits and how we have considered them in our estimates. All costs are presented in 2022 dollars (2022\$), unless noted otherwise. For both the reference and final standards scenarios, we used the MOVES outputs discussed in RIA Chapter 4<sup>913</sup> to compute technology costs and operating costs as well as social costs on an annual basis. The costs and tax credits are estimated on a per vehicle basis and do not change between the reference and final standards cases, but the estimated vehicle populations of the ICE vehicles, BEVs or FCEVs do change between the reference and final standards cases. The modeled potential compliance pathway's technology packages project an increase in BEV and FCEV sales and a decrease in ICE vehicle sales in the final standards case compared to the reference case and these changes in vehicle populations are the determining factor for total cost differences between the reference and final standards cases.

In general, the final rule cost analysis methodology mirrors the approach we

<sup>913</sup> As discussed in RIA Chapter 4.2.2, the final standards scenario or case represents emissions in the U.S. with the final HD GHG Phase 3 standards.



took for the proposal, with some updates to our modeling. Our final rule analysis was conducted using the latest dollar value, 2022\$, which represents an update from the 2021\$ used in the NPRM analysis. Many of our direct manufacturing costs of technologies have been revised based on consideration of comments and data received, as discussed in more detail in preamble section II. Similarly, the operating costs including fuel prices, electricity prices (now for both depot and public charging), and hydrogen prices have been updated, including to reflect the latest projections, as described in RIA Chapter 2. The purchaser costs for the final rule reflect the Move to first inclusion of insurance costs, sales tax, and the Federal excise tax as applicable, also described in that Chapter 2. The maintenance and repair costs for vocational ICE vehicles have been reduced, after consideration of comments. This change led to a decrease in the M&R costs of the BEVs and FCEVs accordingly,<sup>914</sup> but in addition we applied higher M&R costs for BEVs and FCEVs in the early years of the Phase 3 program. These changes are explained in more detail in RIA Chapter 2. Finally, battery replacement, ICE vehicle engine rebuilds, and EVSE replacements are additional operating costs in the final rule that were not included in the NPRM. It is worth noting that, as described in preamble section V, the overall cost savings of the final program are lower than the proposal due to the increased number of ZEVs considered in the reference case

<sup>914</sup> As described in the NPRM and in this section IV, our methodology to estimate BEV and FCEV maintenance costs involves multiplying diesel vehicle maintenance costs by a factor based on cited research.

(reflecting manufacturers' compliance with the ACT program in California and in the seven other states and a lower, non-zero level of ZEV adoption in the other 42 states as discussed in preamble section V.A) and a slower phase in of final standards.

Note that the analysis that follows sometimes presents undiscounted costs and sometimes presents discounted costs. We discount future costs and benefits to properly characterize their value in the present or, as directed by the Office of Management and Budget in the currently applicable Circular A-4 (2003), in the year costs and benefits begin. Also, in that same guidance, OMB directs use of both 3 and 7 percent discount rates as we have done with some exceptions.<sup>915</sup> While we were conducting the analysis for this rule, OMB finalized an update to Circular A-4 (2023),<sup>916</sup> in which it recommended the general application of a 2-percent discount rate to costs and benefits. The January 1, 2025, effective date of the updated Circular A-4 means that the updated Circular A-4 does not apply to this rulemaking, we have also included 2 percent discount rates in our analysis. Present and annualized values are abbreviated as PV and AV throughout the document tables in this section.

<sup>915</sup> See Advisory Circular A-4, Office of Management and Budget, September 17, 2003.

<sup>916</sup> See updated Advisory Circular A-4, Office of Management and Budget, November 9, 2023. The effective date of the updated Circular is March 1, 2024, for regulatory analyses received by OMB in support of proposed rules, interim final rules, and direct final rules, and January 1, 2025, for regulatory analyses received by OMB in support of other final rules. In other words, the updated Circular applies to the regulatory analyses for draft proposed rules that are formally submitted to OIRA after February 29, 2024, and for draft final rules that are formally submitted to OIRA after December 31, 2024.

We received various costs-related comments for vehicle costs, EVSE costs, state sales tax, Federal excise tax, maintenance and repair, insurance, fuel and charging costs, as well as comments regarding the implications of the IRA and BIL. Many of these comments are summarized and responded to in preamble section II, and the detailed comments and our responses are in RTC sections 2 and 3. Any applicable changes to costs discussed in those sections and RIA Chapter 2 are reflected in the rest of this preamble section and in RIA Chapter 3.

In addition, we received comments on learning and RPE, and those comments are addressed in this section and in RTC section 12. Briefly, for RPE, commenters argued that EPA used too low of a factor and based the RPE on dated information, but commenters did not provide better, more recent, or additional data. We therefore continue to consider our NPRM approach to be appropriate and provide more recent supporting data in section 14.2 of the RTC. For the learning curve used in the NPRM, there was generally agreement across commenters on this issue that some accounting for savings reflecting learning was appropriate. However, some commenters acknowledged savings over time attributed to learning by doing but maintained that the learning process has commenced already since heavy-duty BEVs are already being produced and sold. After consideration of comments that BEV learning has begun, for the final rule, we shifted the battery learning onto the flatter portion of the learning curve used in the proposal as shown in Figure IV-1. Details of this adjustment are in Chapter 2.4 of the RIA.

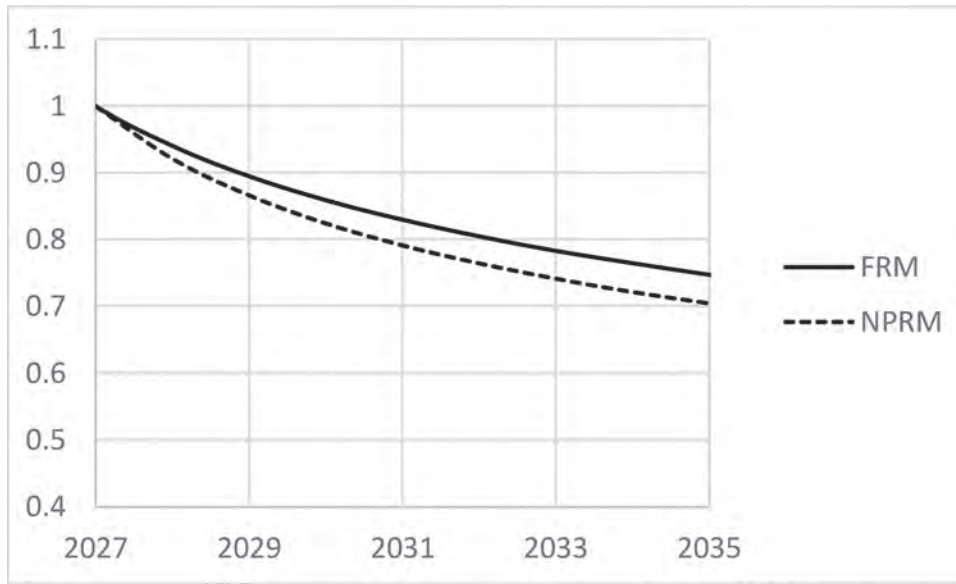

Figure IV-1 BEV Learning Factors in the FRM and NPRM

We also received comment about inclusion of dealer costs and we estimate them as a portion of RPE in the indirect manufacturing costs of technology package costs in the final rule, as discussed in section IV.B.2 and in Chapter 3 of the RIA.

**A. IRA Tax Credits**

Our cost analysis quantitatively includes consideration of three IRA tax credits, specifically the “Advanced Manufacturing Production Credit,” “Qualified Commercial Clean Vehicles,” and “Alternative Fuel Refueling Property Credit” applied to battery cost, vehicle purchase cost, and EVSE purchase cost respectively (sections II.E.1, II.E.2, II.E.3, and II.E.4 of the preamble and Chapters 1.3.2 and 2.4.3 of the RIA). We note that a detailed discussion of how these tax credits were considered in our analysis of costs in our technology packages may be found in section II.E of the preamble and Chapter 2.4.3 of the RIA. The battery tax credit is expected to reduce manufacturer costs, and in turn purchaser costs, as discussed in section IV.C. The vehicle tax credit and EVSE tax credit are also expected to reduce purchaser costs, as discussed in section IV.D.2. For the cost analysis discussed in this section IV, the battery tax credit, vehicle tax credit and EVSE tax credit were estimated for MYs 2027 through 2032 and then aggregated for each MOVES source type and regulatory class.

**B. Technology Package Costs**

Technology package costs include estimated technology costs associated

with compliance with the final MY 2027 and later CO<sub>2</sub> emission standards (see Chapter 3 of the RIA) based on the projected technology packages modeled for the potential compliance pathway. Individual technology piece costs are presented in Chapters 2 of the RIA. In general, for the first MY of each final emission standard, the per vehicle individual technology piece costs consist of the DMC estimated for each vehicle in the model year of the final standards and are used as a starting point in estimating both the technology package costs and the total incremental costs. Following each year of when costs are first incurred, we have applied a learning effect to represent the cost reductions expected to occur via the “learning by doing” phenomenon.<sup>917</sup> However, for the final rule, we started the BEV learning scale in MY 2026, rather than MY 2027 after consideration of comments received that BEV learning may begin before MY 2027. This was implemented by recalculating the BEV learning scalars, such that MY 2027 is equal to a learning value of 1 but retaining the growth rate as if the scalar started in MY 2026. See RIA Chapter 3.2.1 for a more detailed description of how this was implemented. The “learning by doing” phenomenon is the process by which doing something over and over results in learning how to do that thing more efficiently which, in turn, leads to reduced resource usage, *i.e.*, cost savings. The DMC as modified

year-by-year by a learning factor provides a year-over-year cost for each technology as applied to new vehicle production, which EPA then used to calculate total technology package costs of the final standards.

This technology package cost calculation approach presumes that the projected technologies (*i.e.*, those in the particular technology package developed by EPA as a potential compliance pathway to support the feasibility of the final standards) will be purchased by the vehicle original equipment manufacturers (OEMs) from their suppliers. So, while the DMC estimates for the OEM in section IV.B.1 include the indirect costs and profits incurred by the supplier, the indirect cost markups we apply in section IV.B.2 cover the indirect costs incurred by OEMs to incorporate the new technologies into their vehicles and the profit margins for the OEM typical of the heavy-duty vehicle industry. To address these OEM indirect costs, we then applied industry standard RPE markup factors to the DMC to estimate indirect costs associated with the new technology. These factors represent an average price, or RPE, for products assuming all products recapture costs in the same way. We recognize that this is rarely the actual case since manufacturers typically have different pricing strategies for different products. For that reason, the RPE should not be considered the price for each individual technology package but instead should be considered more like the average price needed to recapture both costs and profits to support ongoing business

<sup>917</sup> “Cost Reduction through Learning in Manufacturing Industries and in the Manufacture of Mobile Sources, Final Report and Peer Review Report,” EPA-420-R-16-018, November 2016.

operations. Both the learning effects applied to direct costs and the application of markup factors to estimate indirect costs are consistent with the cost estimation approaches used in EPA’s past HD GHG regulatory programs.<sup>918</sup> The sum of the DMC and indirect costs represents our estimate of technology “package costs” or “package RPE” per vehicle year-over-year. These per vehicle technology package costs are multiplied by estimated sales for the final standards and reference scenarios. Then the total technology package-related costs for manufacturers (total package costs or total package RPE) associated with the final HD GHG Phase 3 standards is the difference between the final standards and reference scenarios.

1. Direct Manufacturing Costs

To produce a unit of output, manufacturers incur direct and indirect manufacturing costs. DMC include cost of materials and labor costs. Indirect manufacturing costs are discussed in the following section, IV.B.2. The DMCs presented here include the incremental technology piece costs associated with compliance with the final standards as compared to the technology piece costs associated with the comparable baseline vehicle.<sup>919</sup> Our modeled potential compliance pathway to meet the final standards are technology packages that include both ICE vehicle and ZEV technologies. In our analysis, the ICE vehicles include a suite of technologies that represent a vehicle that meets the previous MY 2027 Phase 2 CO<sub>2</sub> emission standards. Therefore, our direct manufacturing costs for the ICE vehicles are considered to be \$0 because our projected technology package did not add additional CO<sub>2</sub>-reducing technologies to the ICE vehicles beyond those in the baseline vehicle (we note that even though such improvements were not included in the modeled potential compliance pathway, additional improvements and technologies for vehicles with ICE are feasible and manufacturers could utilize such technologies to meet the final standards; see preamble section II.F for examples of additional potential compliance pathways that include technologies for vehicles with ICE with such improvements). The DMC of the BEVs or FCEVs could be thought of as

the technology piece costs of replacing a comparable ICE powertrain baseline vehicle with a BEV or FCEV powertrain. Note, reference case costs estimates also include costs associated with replacing a comparable ICE powertrain baseline vehicle with a BEV or FCEV powertrain for ZEV adoption rates in the reference case.

We have estimated the DMC by estimating the cost of removing the cost of the ICE powertrain, and adding the cost of a BEV or FCEV powertrain, as presented in Chapter 2 and 3 of the RIA. In other words, net incremental costs reflect adding the total costs of components added to the powertrain to make it a BEV or FCEV, as well as removing the total costs of components removed from a comparable ICE baseline vehicle to make it a BEV or FCEV.

Chapter 4 of the RIA contains a description of the MOVES vehicle source types and regulatory classes. In short, we estimate costs in MOVES for vehicle source types that have both regulatory class populations and associated emission inventories. Also, throughout this section, LHD refers to light heavy-duty vehicles, MHD refers to medium heavy-duty vehicles, and HHD refers to heavy heavy-duty vehicles.<sup>920</sup>

The direct costs are then adjusted to account for learning effects on BEV, FCEV and ICE vehicle powertrains on an annual basis going forward beginning with the first year of the analysis, e.g., MY 2027, for the final standards and reference scenarios. Overall, under the modeled potential compliance pathway we anticipate the number of ICE powertrains (including engines and transmissions) manufactured each year will decrease as more ZEVs enter the market. Due to decreasing production of ICE powertrains, this scenario may lead to slower cost reductions going forward than would typically occur from learning-by-doing in the context of component costs for ICE powertrains. On the other hand, with the inclusion of new hardware costs projected in our HD2027 final rule’s modeled potential compliance pathway to meet the HD2027 emission standards, we expect learning effects will reduce the incremental cost of these technologies. Chapter 2 and 3 of the RIA includes a detailed description of the approach used to apply learning effects in this analysis and reflects consideration of the comments received on our approach to learning. The resultant DMC per

vehicle and how those costs decrease over time on a fleet level are presented in section IV.E.1 of this preamble.

2. Indirect Manufacturing Costs

Indirect manufacturing costs are all the costs associated with producing the unit of output that are not direct manufacturing costs—for example, they may be related to research and development (R&D), warranty, corporate operations (such as salaries, pensions, health care costs, dealer support, and marketing) and profits. An example of a R&D cost for these final standards includes the engineering resources required to develop a battery state of health monitor as described in preamble section III.B.1. An example of a warranty cost is the future cost covered by the manufacturer to repair defective BEV or FCEV components and meet the warranty requirements discussed in section III.B.2. Indirect costs are generally recovered by allocating a share of the indirect costs to each unit of goods sold. Although direct costs can be allocated to each unit of goods sold, it is more challenging to account for indirect costs allocated to a unit of goods sold. To ensure that regulatory analyses capture the changes in indirect costs, markup factors (which relate total indirect costs to total direct costs) have been developed and used by EPA and other stakeholders. These factors are often referred to as RPE multipliers and are typically applied to direct costs to estimate indirect costs. RPE multipliers provide, at an aggregate level, the proportionate share of revenues relative shares of revenue where:

$$\begin{aligned} \text{Revenue} &= \text{Direct Costs} + \text{Indirect Costs} \\ \text{Revenue/Direct Costs} &= 1 + \text{Indirect Costs/Direct Costs} = \text{RPE multiplier} \end{aligned}$$

Resulting in:

$$\text{Indirect Costs} = \text{Direct Costs} \times (\text{RPE} - 1)$$

If the relationship between revenues and direct costs (i.e., RPE multiplier) can be shown to equal an average value over time, then an estimate of direct costs can be multiplied by that average value to estimate revenues, or total costs. Further, that difference between estimated revenues, or total costs, and estimated direct costs can be taken as the indirect costs. Cost analysts and regulatory agencies have frequently used these multipliers to predict the resultant impact on costs associated with manufacturers’ responses to regulatory requirements and we are using that approach in this analysis.

The final cost analysis estimates indirect costs by applying the RPE markup factor used in past EPA rulemakings (such as those setting GHG standards for heavy-duty vehicles and

<sup>918</sup> See the Phase 1 heavy-duty greenhouse gas rule (76 FR beginning at 57319, September 15, 2011); the Phase 2 heavy-duty greenhouse gas rule (81 FR 73863, October 25, 2016).

<sup>919</sup> Baseline vehicles are ICE vehicles meeting the previous MY 2027 Phase 2 standards discussed in RIA Chapter 2.2.2 and the HD2027 Low NO<sub>x</sub> standards discussed in RIA Chapter 2.3.2.

<sup>920</sup> As explained in preamble section V, MOVES vehicle definitions encompass the regulatory subcategories of the final standards but are not identical to them.

engines).<sup>921</sup> The markup factors are based on company filings with the Securities and Exchange Commission for several engine and engine/vehicle

manufacturers in the heavy-duty industry.<sup>922</sup> The RPE factors for the HD vehicle industry as a whole are shown in Table IV-1. Also shown in Table IV-

1 are the RPE factors for light-duty vehicle manufacturers.<sup>923</sup>

**Table IV-1 Retail Price Equivalent Factors in the Heavy-Duty and Light-Duty Industries**

Cost Contributor	HD Truck Industry <sup>a</sup>	LD Vehicle Industry
Direct manufacturing cost	1.00	1.00
Warranty	0.03	0.03
R&D	0.05	0.05
Other (admin, retirement, health, dealer, etc.)	0.29	0.36
Profit (cost of capital)	0.05	0.06
RPE	1.42	1.50

<sup>a</sup> Note that the report used the term “HD Truck” while EPA generally uses the term “HD vehicle;” they are equivalent when referring to this report.

For this analysis, EPA based indirect cost estimates for diesel and compressed natural gas (CNG) regulatory classes on the HD Truck Industry RPE value shown in Table IV-1. We are using an RPE of 1.42 to compute the indirect costs associated with the replacement of a diesel-fueled or CNG-fueled powertrain with a BEV or FCEV powertrain. For this analysis, EPA based indirect cost estimates for gasoline regulatory classes on the LD Vehicle RPE value shown in Table IV-1 because the engines and vehicles more closely match those built by LD vehicle manufacturers. We are using an RPE of 1.5 to compute the indirect costs associated with the replacement of a gasoline-fueled powertrain with a BEV or FCEV powertrain. The heavy-duty vehicle industry is becoming more vertically integrated and the direct and indirect manufacturing costs we are analyzing are those that reflect the technology packages costs OEMs would try to recover at the end purchaser, or retail,

level. For that reason, we believe the two respective vehicle industry RPE values represent the most appropriate factors for this analysis. EPA received comments on RPE and commenters argued that EPA used too low of a factor and based the RPE on dated information. After consideration of the comment, EPA has clarified that the RPE accounts for dealer costs, as described in this section. Including this clarification, EPA finds that the multiplier we used is appropriate and based on robust data and analysis. Moreover, commenters did not provide better, more recent, or additional data to update values for RPE, and EPA is not aware of any such data. Therefore, we continue with the approach used in the NPRM.

EPA received comment that dealers may encounter new costs when new products are introduced (which we refer to in this rulemaking as “dealer new vehicle selling costs”), such as technician training to repair ZEVs. After

consideration of comment, EPA is clarifying that we accounted for these costs in the RPE multipliers.<sup>924</sup> The heavy-duty RPE in Table IV-1 is based on values from the report, “Heavy Duty Truck Retail Price Equivalent and Indirect Cost Multipliers,”<sup>925</sup> which contains detailed cost contributor subcategories, including costs associated with dealer support. Within the dealer support costs, the contribution of new dealer selling costs in the RPE mark-up includes a 6 percent markup over manufacturing cost for dealer new vehicle selling costs, from the “Other” cost contributor shown in Table IV-1.

Dealer new vehicle selling costs for CY 2027 through 2032 are shown in Table IV-2. We calculated the dealer new vehicle selling costs as 6 percent of the total direct cost calculated for the final standards. Table IV-2 also shows the undiscounted sum of dealer new vehicle selling costs from CY 2027 to 2032.

**Table IV-2 Dealer new vehicle selling costs for final standards, undiscounted in Millions of 2022\$<sup>a</sup>**

Calendar Year	Dealer new vehicle selling costs for final standards
2027	\$20
2028	\$21
2029	\$17
2030	\$26
2031	\$30
2032	\$35
Sum of 2027 to 2032	\$150

<sup>a</sup> Values rounded to two significant digits.

<sup>921</sup> 76 FR 57322; 81 FR 73863.

<sup>922</sup> Heavy Duty Truck Retail Price Equivalent and Indirect Cost Multipliers, Draft Report, July 2010.

<sup>923</sup> Rogozhin, A., et al., Using indirect cost multipliers to estimate the total cost of adding new

technology in the automobile industry. International Journal of Production Economics (2009), doi:10.1016/j.ijpe.2009.11.031.

<sup>924</sup> See also preamble section II.E.5 explaining that our cost savings estimates for maintenance and

repair reflect a later start date for BEVs and FCEVs to account for the need for initial technician training.

<sup>925</sup> Heavy Duty Truck Retail Price Equivalent and Indirect Cost Multipliers, Draft Report, July 2010.

3. Vehicle Technology Package RPE

Table IV-3 presents the total fleet-wide incremental technology costs estimated for the final standards relative to the reference case for the projected adoption of ZEVs in our technology package on an annual basis. As previously explained in this section, the costs shown in Table IV-3 reflect marginal direct and indirect manufacturing costs of the technology

package for the final standards as compared to the baseline vehicle.

It is important to note that these are costs and not prices. As we explained previously in this section, we do not attempt to estimate how manufacturers will price their products in the technology package costs. Manufacturers may pass costs along to purchasers via price increases that reflect actual incremental costs to manufacture a ZEV when compared to

a comparable ICE vehicle. However, manufacturers may also price products higher or lower than what would be necessary to account for the incremental cost difference. EPA is not attempting to mirror, predict, or otherwise approximate individual companies' marketing strategies in estimating costs for the modeled potential compliance pathway.<sup>926</sup>

**BILLING CODE 6560-50-P**

<sup>926</sup> We have likewise noted that our modeled potential compliance pathway is just one potential means manufacturers may use to meet the final standards. By law, EPA must consider the compliance costs of standards, and to do so, must develop a potential compliance pathway for such standards in order to estimate those costs.

**Table IV-3 Total Fleet-Wide Incremental Technology Costs for ZEVs, for the Final Standards Relative to the Reference Case Millions of 2022\$<sup>a</sup>**

Calendar Year	Vehicle Package RPE
2027	\$30
2028	-\$14
2029	-\$85
2030	\$160
2031	\$270
2032	\$480
2033	\$310
2034	\$260
2035	\$160
2036	\$23
2037	-\$25
2038	-\$140
2039	-\$230
2040	-\$260
2041	-\$330
2042	-\$400
2043	-\$390
2044	-\$450
2045	-\$510
2046	-\$490
2047	-\$530
2048	-\$560
2049	-\$590
2050	-\$570
2051	-\$590
2052	-\$620
2053	-\$640
2054	-\$610
2055	-\$590
PV, 2%	-\$4,200
PV, 3%	-\$3,200
PV, 7%	-\$1,000
AV, 2%	-\$190
AV, 3%	-\$170
AV, 7%	-\$83

<sup>a</sup> Values rounded to two significant digits; negative values denote lower costs, i.e., savings in expenditures.

*C. Manufacturer Costs*

1. Relationship to Technology Package RPE

The manufacturer costs in EPA’s past HD GHG rulemaking cost analyses on an average-per-vehicle basis was only the average-per-vehicle technology package RPE described in section II.F. However, in the cost analysis for this final rule, we are also taking into account the IRA battery tax credit in our estimates of manufacturer costs (also referred to in

this section as manufacturer’s RPE), as we expect the battery tax credit to reduce manufacturer costs, and in turn purchaser costs. The DMCs without the battery tax credit are included in section IV.E.1.

2. Battery Tax Credit

Table IV–4 shows the annual estimated fleet-wide battery tax credits from IRA section 13502, “Advanced Manufacturing Production Credit,” for the final standards relative to the

reference case in 2022\$ under the potential compliance pathway. These estimates were based on the detailed discussion in RIA Chapter 2 of how we considered battery tax credits. Both BEVs and FCEVs include a battery in the powertrain system that may meet the IRA battery tax credit requirements if the applicable criteria are met. The battery tax credits begin to phase down starting in CY 2030 and expire after CY 2032.

**Table IV-4 Battery Tax Credit in Millions of 2022\$ for the Final Standards Relative to the Reference Case<sup>a</sup>**

Calendar Year	Battery Tax Credits
2027	\$67
2028	\$130
2029	\$200
2030	\$290
2031	\$440
2032	\$380
2033 and later	\$0
PV, 2%	\$1,400
PV, 3%	\$1,300
PV, 7%	\$1,100
AV, 2%	\$63
AV, 3%	\$69
AV, 7%	\$92

<sup>a</sup> Values rounded to two significant digits.

**3. Manufacturer RPE**

The manufacturer RPE for BEVs is calculated by subtracting the battery tax credit in Table IV-4 from the corresponding technology package RPE from Table IV-3 and the resultant

manufacturer RPE is shown in Table IV-5. Table IV-5 reflects learning effects on vehicle package RPE and battery tax credits from CY 2027 through 2055. The sum of the vehicle package RPE and battery tax credits for each year is

shown in the manufacturer RPE column. The difference in manufacturer RPE under the potential compliance pathway between the final standards and reference case is presented in Table IV-5.

**Table IV-5 Total Vehicle Package RPE, Battery Tax Credits, and Manufacturer RPE (including Battery Tax Credits) for the Final Standards Relative to the Reference Case, All Regulatory Classes and All Fuels, Millions of 2022\$<sup>a</sup>**

Calendar Year	Vehicle Package RPE	Battery Tax Credits	Manufacturer RPE
2027	\$30	-\$67	-\$37
2028	-\$14	-\$130	-\$140
2029	-\$85	-\$200	-\$290
2030	\$160	-\$290	-\$130
2031	\$270	-\$440	-\$170
2032	\$480	-\$380	\$100
2033	\$310	\$0	\$310
2034	\$260	\$0	\$260
2035	\$160	\$0	\$160
2036	\$23	\$0	\$23
2037	-\$25	\$0	-\$25
2038	-\$140	\$0	-\$140
2039	-\$230	\$0	-\$230
2040	-\$260	\$0	-\$260
2041	-\$330	\$0	-\$330
2042	-\$400	\$0	-\$400
2043	-\$390	\$0	-\$390
2044	-\$450	\$0	-\$450
2045	-\$510	\$0	-\$510
2046	-\$490	\$0	-\$490
2047	-\$530	\$0	-\$530
2048	-\$560	\$0	-\$560
2049	-\$590	\$0	-\$590
2050	-\$570	\$0	-\$570
2051	-\$590	\$0	-\$590
2052	-\$620	\$0	-\$620
2053	-\$640	\$0	-\$640
2054	-\$610	\$0	-\$610
2055	-\$590	\$0	-\$590
PV, 2%	-\$4,200	-\$1,400	-\$5,500
PV, 3%	-\$3,200	-\$1,300	-\$4,500
PV, 7%	-\$1,000	-\$1,100	-\$2,100
AV, 2%	-\$190	-\$63	-\$250
AV, 3%	-\$170	-\$69	-\$240
AV, 7%	-\$83	-\$92	-\$170

<sup>a</sup> Values rounded to two significant digits; negative values denote lower costs, i.e., savings in expenditures.

*D. Purchaser Costs*

1. Purchaser RPE

The purchaser RPE is the estimated upfront vehicle cost paid by the purchaser prior to considering the IRA vehicle tax credits. Note, as explained in section IV.C, we do consider the IRA battery tax credit in estimating the manufacturer RPE, which in this analysis we then consider to be equivalent to the purchaser RPE because we assume full pass-through of the IRA

battery tax credit from the manufacturer to the purchaser. In other words, in this analysis, the manufacturer RPE and purchaser RPE are equivalent terms. The purchaser RPEs reflect the same values as the corresponding manufacturer RPEs presented in section IV.C.3.

2. Vehicle Purchase Tax Credit

Table IV-6 shows the annual estimated vehicle tax credit for BEVs and FCEVs from IRA section 13403, “Qualified Commercial Clean Vehicles,”

for the final standards relative to the reference case, in 2022\$ under the potential compliance pathway. These estimates were based on the detailed discussion in RIA Chapter 2 of how we considered vehicle tax credits. The vehicle tax credits carry through to MY 2032 with the value diminishing over time as vehicle costs decrease due to the learning effect as shown in RIA Chapter 2. Beginning in CY 2033, the tax credit program expires.



**Table IV-6 Vehicle Tax Credit in Millions 2022\$ for the Final Standards Relative to the Reference Case<sup>a</sup>**

Calendar Year	Tax Credit
2027	\$39
2028	\$23
2029	\$10
2030	\$180
2031	\$450
2032	\$940
2033 and later	\$0
PV, 2%	\$1,500
PV, 3%	\$1,400
PV, 7%	\$1,100
AV, 2%	\$67
AV, 3%	\$73
AV, 7%	\$93

<sup>a</sup> Values rounded to two significant digits.

**3. Electric Vehicle Supply Equipment Costs**

As we included in the analysis for the NPRM, we accounted for the EVSE hardware and associated installation costs for equipment installed at depots, as described in Chapter 2.6 of the RIA. For the final rule, we have also included BEVs that would solely depend on public charging in the technology package to support the final standards. The purchasers of these vehicles would not incur an upfront cost to purchase and install EVSE. As discussed in RIA Chapter 2.4.4.2 for public charging and in Chapter 2.5.3 for FCEVs, we included the respective infrastructure cost in our retail electricity prices per kwh and retail prices per kg of hydrogen in our

operating costs. These end user costs include the production, distribution, storage, and dispensing at a public charging or fueling station. This approach is consistent with the method we use in HD TRUCS for comparable ICE vehicles, where the equivalent diesel fuel costs are included in the diesel fuel price instead of accounting for the costs of fuel stations separately.

The depot EVSE cost estimates include both direct and indirect costs and are sometimes referred to in these final standards as EVSE RPE costs. As discussed in RIA Chapter 2.6.2, we increased the depot EVSE costs for the final rule to reflect consideration of the cost data we received in comments. For these EVSE cost estimates, we project

that up to two vehicles can share one DCFC port if there is sufficient dwell time for both vehicles to meet their daily charging needs for vocational vehicles and up to four for tractors.<sup>927</sup> While fleet owners may also choose to share Level 2 chargers across vehicles, we are conservatively assigning one Level 2 charger per vehicle. As discussed in the RIA, we assume that EVSE costs are incurred by purchasers, *i.e.*, heavy-duty vehicle purchasers/owners. We analyzed EVSE costs in 2022\$ on a fleet-wide basis under the potential compliance pathway for this analysis. The annual costs associated with EVSE in the final standards relative to the reference case are shown in Table IV-7.

<sup>927</sup> We note that for some of the vehicle types we evaluated, more than two vehicles could share a

DCFC port and still meet their daily electricity consumption needs.

**Table IV-7 Depot EVSE Costs for the Final Standards Relative to the Reference Case, Millions 2022\$<sup>a</sup>**

Calendar Year	EVSE RPE Costs
2027	\$440
2028	\$610
2029	\$730
2030	\$630
2031	\$1,300
2032	\$2,000
2033	\$1,900
2034	\$1,700
2035	\$1,600
2036	\$1,600
2037	\$1,500
2038	\$1,500
2039	\$1,500
2040	\$1,500
2041	\$1,500
2042	\$1,400
2043	\$1,400
2044	\$1,400
2045	\$1,400
2046	\$1,300
2047	\$1,300
2048	\$1,300
2049	\$1,300
2050	\$1,200
2051	\$1,200
2052	\$1,200
2053	\$1,200
2054	\$1,200
2055	\$1,100
PV, 2%	\$28,000
PV, 3%	\$25,000
PV, 7%	\$15,000
AV, 2%	\$1,300
AV, 3%	\$1,300
AV, 7%	\$1,300

<sup>a</sup> Values rounded to two significant digits.

4. EVSE Tax Credit

Table IV-8 shows the annual estimated EVSE tax credit from IRA section 13404, “Alternative Fuel

Refueling Property Credit,” for the final standards relative to the reference case, in 2022\$ under the potential compliance pathway. These estimates were based on the detailed discussion in

RIA Chapter 2 of how we considered EVSE tax credits. The EVSE tax credits carry through to MY 2032. Beginning in CY 2033, the tax credit program expires.

**Table IV-8 EVSE Tax Credit in Millions 2022\$ for the Final Standards Relative to the Reference Case<sup>a</sup>**

Calendar Year	Tax Credit
2027	\$79
2028	\$110
2029	\$130
2030	\$110
2031	\$240
2032	\$360
2033 and later	\$0
PV, 2%	\$950
PV, 3%	\$910
PV, 7%	\$770
AV, 2%	\$43
AV, 3%	\$47
AV, 7%	\$63

<sup>a</sup> Values rounded to two significant digits.

5. Federal Excise Tax, State Sales Tax

As discussed in preamble section II.E.5, in the NPRM we did not account for the upfront taxes paid by the purchaser of the vehicle. Several commenters raised concerns about additional costs that were not included in HD TRUCS for the proposal. The concern raised by the greatest number of commenters was the additional cost from Federal excise tax and state sales

tax because of higher BEV and FCEV upfront vehicle cost under the potential compliance pathway. We agree with the commenters that the cost analysis should include the impact of the FET and State Sales Tax on purchasers. For the final rule, we added FET and state sale tax as a part of the purchaser upfront vehicle cost calculation. A FET of 12 percent was applied to the upfront powertrain technology retail price equivalent for Class 8 heavy-duty

vehicles and all tractors, as discussed in RIA Chapter 2.4.3.2. Similarly, a state tax of 5.02 percent, the average sales tax in the U.S. for heavy-duty vehicles discussed in RIA Chapter 2.4.3.1, was applied to the upfront powertrain technology retail price equivalent and was added to all vehicles for the final rule analysis. Table IV-9 shows the estimated state sales tax and Federal excise tax by calendar year for the final standards relative to the reference case.

**Table IV-9 Incremental Federal Excise Tax and State Sales Tax for the Final Standards Relative to the Reference Case for in Millions 2022\$<sup>a</sup>**

Calendar Year	State Sales Taxes	Federal Excise Taxes
2027	-\$1.9	\$1.1
2028	-\$7.2	-\$0.90
2029	-\$14	-\$7.6
2030	-\$6.4	\$16
2031	-\$8.7	\$44
2032	\$5	\$110
2033	\$15	\$120
2034	\$13	\$110
2035	\$8	\$99
2036	\$1.1	\$88
2037	-\$1.3	\$82
2038	-\$7	\$73
2039	-\$12	\$64
2040	-\$13	\$61
2041	-\$17	\$54
2042	-\$20	\$47
2043	-\$20	\$45
2044	-\$23	\$39
2045	-\$26	\$33
2046	-\$25	\$32
2047	-\$27	\$28
2048	-\$28	\$24
2049	-\$30	\$19
2050	-\$28	\$20
2051	-\$30	\$17
2052	-\$31	\$13
2053	-\$32	\$10
2054	-\$30	\$11
2055	-\$30	\$11
PV, 2%	-\$280	\$990
PV, 3%	-\$230	\$890
PV, 7%	-\$110	\$580
AV, 2%	-\$13	\$45
AV, 3%	-\$12	\$46
AV, 7%	-\$8.8	\$47

<sup>a</sup> Values rounded to two significant digits; negative values denote lower costs, i.e., savings in expenditures.

**6. Purchaser Upfront Costs**

The expected upfront incremental costs to the purchaser include the purchaser upfront vehicle costs plus the purchaser upfront EVSE costs as applicable, after tax credits and including FET and sales state tax, under the potential compliance pathway. In other words, the estimated purchaser

upfront incremental costs include the purchaser RPE discussed in section IV.D.1 less the vehicle tax credit discussed in section IV.D.2 plus the EVSE RPE in IV.D.3 less the EVSE tax credit in section IV.D.4 and plus the Federal excise tax and state sales tax in section IV.D.5. Table IV-10 shows the estimated incremental upfront purchaser costs for BEVs and FCEVs by

calendar year for the final standards relative to the reference case. Note that EVSE costs are associated only with BEVs using depot charging; FCEVs and BEVs solely using public charging do not have any associated upfront EVSE costs because those costs are reflected in the public hydrogen refueling and charging electricity costs.

**Table IV-10 Incremental Purchaser Upfront Costs for the Final Standards Relative to the Reference Case for in Millions 2022S<sup>a</sup>**

Calendar Year	Purchaser RPE	Vehicle Purchase Tax Credit	State Sales Taxes	Federal Excise Taxes	EVSE Costs for Depot Charging	EVSE Tax Credit	Total Upfront Purchaser Cost
2027	-\$37	-\$39	-\$1.9	\$1.1	\$440	-\$79	\$280
2028	-\$140	-\$23	-\$7.2	-\$0.90	\$610	-\$110	\$330
2029	-\$290	-\$10	-\$14	-\$7.6	\$730	-\$130	\$280
2030	-\$130	-\$180	-\$6.4	\$16	\$630	-\$110	\$210
2031	-\$170	-\$450	-\$8.7	\$44	\$1,300	-\$240	\$500
2032	\$100	-\$940	\$5	\$110	\$2,000	-\$360	\$920
2033	\$310	\$0	\$15	\$120	\$1,900	\$0	\$2,300
2034	\$260	\$0	\$13	\$110	\$1,700	\$0	\$2,100
2035	\$160	\$0	\$8	\$99	\$1,600	\$0	\$1,800
2036	\$23	\$0	\$1.1	\$88	\$1,600	\$0	\$1,700
2037	-\$25	\$0	-\$1.3	\$82	\$1,500	\$0	\$1,600
2038	-\$140	\$0	-\$7	\$73	\$1,500	\$0	\$1,500
2039	-\$230	\$0	-\$12	\$64	\$1,500	\$0	\$1,300
2040	-\$260	\$0	-\$13	\$61	\$1,500	\$0	\$1,300
2041	-\$330	\$0	-\$17	\$54	\$1,500	\$0	\$1,200
2042	-\$400	\$0	-\$20	\$47	\$1,400	\$0	\$1,100
2043	-\$390	\$0	-\$20	\$45	\$1,400	\$0	\$1,100
2044	-\$450	\$0	-\$23	\$39	\$1,400	\$0	\$960
2045	-\$510	\$0	-\$26	\$33	\$1,400	\$0	\$860
2046	-\$490	\$0	-\$25	\$32	\$1,300	\$0	\$850
2047	-\$530	\$0	-\$27	\$28	\$1,300	\$0	\$780
2048	-\$560	\$0	-\$28	\$24	\$1,300	\$0	\$710
2049	-\$590	\$0	-\$30	\$19	\$1,300	\$0	\$650
2050	-\$570	\$0	-\$28	\$20	\$1,200	\$0	\$650
2051	-\$590	\$0	-\$30	\$17	\$1,200	\$0	\$610
2052	-\$620	\$0	-\$31	\$13	\$1,200	\$0	\$560
2053	-\$640	\$0	-\$32	\$10	\$1,200	\$0	\$510
2054	-\$610	\$0	-\$30	\$11	\$1,200	\$0	\$530
2055	-\$590	\$0	-\$30	\$11	\$1,100	\$0	\$530
PV, 2%	-\$5,500	-\$1,500	-\$280	\$990	\$28,000	-\$950	\$21,000
PV, 3%	-\$4,500	-\$1,400	-\$230	\$890	\$25,000	-\$910	\$19,000
PV, 7%	-\$2,100	-\$1,100	-\$110	\$580	\$15,000	-\$770	\$12,000
AV, 2%	-\$250	-\$67	-\$13	\$45	\$1,300	-\$43	\$970
AV, 3%	-\$240	-\$73	-\$12	\$46	\$1,300	-\$47	\$970
AV, 7%	-\$170	-\$93	-\$8.8	\$47	\$1,300	-\$63	\$960

<sup>a</sup> Values rounded to two significant digits; negative values denote lower costs, i.e., savings in expenditures.

**BILLING CODE 6560-50-C**

**7. Operating Costs**

We have estimated six types of operating costs associated with the final HD GHG Phase 3 emission standards and our potential compliance pathway's projected technology packages that includes ICE, BEV and FCEV

powertrains. These six types of operating costs include changes in fuel costs of BEVs and FCEVs compared to comparable ICE vehicles, avoided diesel exhaust fluid (DEF) consumption by BEVs and FCEVs compared to comparable diesel-fueled ICE vehicles, reduced maintenance and repair costs of BEVs and FCEVs as compared to

comparable ICE vehicles, changes to insurance costs of BEVs and FCEVs as compared to comparable ICE vehicles, battery replacement and ICE engine rebuild costs and EVSE replacement costs. To estimate fuel, DEF and maintenance and repair costs of ICE vehicles, EPA used the results of MOVES runs, as discussed in RIA

Chapter 4, to estimate costs associated with fuel consumption, DEF consumption, and VMT. Similarly, the electricity, hydrogen fuel, and maintenance and repair costs of BEVs and FCEVs were calculated based on the MOVES outputs for fuel/electricity consumption and VMT. EPA added insurance costs for all vehicle types for the final rule analysis based on the incremental upfront cost (purchaser RPE) of the vehicle and calculated for each year a vehicle is operating. For the final rule cost analysis in this section of the preamble, we also accounted for the costs to rebuild diesel engines and battery replacement costs and EVSE replacement costs. We have estimated the net effect on fuel costs, DEF costs, maintenance and repair costs, insurance, battery replacements, engine rebuilds, and EVSE replacements. We describe our approach in this section (IV.D.7).

Additional details on our methodology and estimates of operating costs per mile impacts are included in RIA Chapter 3.4 as well as insurance, ICE engine rebuilds, BEV battery replacement, and EVSE replacement costs. Chapter 4 of the RIA contains a description of the MOVES vehicle source types and regulatory classes. In short, we estimate costs based on MOVES vehicle source types that have both regulatory class populations and associated emission inventories.

i. Costs Associated With Fuel Usage

Costs associated with fuel usage are presented in two ways: on an annual basis for aggregate costs of all vehicles and on a per mile basis for a specific model year in each MOVES source type and regulatory class. The annual costs are presented in section IV.E.3 to show the overall fuel costs of the policy case compared to the reference case for pre-tax fuel. The costs on a per mile basis are given as an example what a specific MY vehicle in a given MOVES source type and regulatory class could estimate to pay on a per mile basis based on the VMT and total cost of all fuel at retail prices used from the first year the vehicle is in operation until CY 2055.

To determine the total costs associated with fuel usage for MY 2032 vehicles, the fuel usage for each MOVES source type and regulatory class was multiplied by the fuel price from the AEO 2023 reference case for diesel, gasoline, and CNG prices over from CY 2032 to CY 2055.<sup>928</sup> Fuel costs per gallon and kWh are discussed in RIA Chapter 2. We used retail fuel prices since we expect that retail fuel prices are the prices paid by owners of these ICE vehicles. For electric vehicle costs, the electricity prices used estimates of the cost per kWh of charging at depot and public charge points along with estimates of the share of charging by

each source type at those respective charge points. The development of the costs per kWh is presented in RIA Chapter 2.4.4.2 and the values used to estimate program costs are shown in Table IV–11. For hydrogen vehicle fuel costs, we used the hydrogen prices presented in RIA Chapter 2.5.3.1 and presented in RIA Chapter 3 and shown in Table IV–12. To calculate the average cost per mile of fuel usage for each scenario, MOVES source type and regulatory class, EPA divided the fuel cost by the VMT for each of the MY 2032 vehicles starting in CY 2032 until CY 2055. The estimates of fuel cost per mile for MY 2032 vehicles under the final rule are shown in Table IV–13, Table IV–14, and Table IV–15 for 2 percent, 3 percent and 7 percent discounting, respectively. Values shown as a dash (“-”) in Table IV–13, Table IV–14, and Table IV–15 represent cases where a given MOVES source type and regulatory class did not use a specific fuel type for MY 2032 vehicles.<sup>929</sup>

The number of ICE vehicles decrease and ZEV increase in the final standards case compared to the reference case therefore the fuel costs for all vehicles are less in final standards case when computed on an annual basis as shown in section IV.E.3 for pre-tax fuel.

**BILLING CODE 6560–50–P**

<sup>928</sup> Reference Case Projection Tables, U.S. Energy Information Administration. Annual Energy Outlook 2023.

<sup>929</sup> For example, there were no vehicles in our MOVES runs for the transit bus source type in the LHD45 regulatory class that were diesel-fueled, so the value in the table is represented as a dash (“-”).

**Table IV-11 Electricity Prices by Type of Charge Point (2022\$ per kWh)<sup>a</sup>**

Calendar Year	Depot Charging	Public Charging
2027	\$0.1236	\$0.1960
2028	\$0.1236	\$0.1960
2029	\$0.1209	\$0.1933
2030	\$0.1183	\$0.1907
2031	\$0.1181	\$0.1905
2032	\$0.1179	\$0.1903
2033	\$0.1177	\$0.1902
2034	\$0.1176	\$0.1900
2035	\$0.1174	\$0.1898
2036	\$0.1172	\$0.1897
2037	\$0.1171	\$0.1895
2038	\$0.1170	\$0.1894
2039	\$0.1168	\$0.1892
2040	\$0.1167	\$0.1891
2041	\$0.1161	\$0.1885
2042	\$0.1155	\$0.1879
2043	\$0.1149	\$0.1873
2044	\$0.1143	\$0.1867
2045	\$0.1137	\$0.1861
2046	\$0.1128	\$0.1852
2047	\$0.1119	\$0.1843
2048	\$0.1110	\$0.1834
2049	\$0.1101	\$0.1826
2050	\$0.1093	\$0.1817
2051	\$0.1093	\$0.1817
2052	\$0.1093	\$0.1817
2053	\$0.1093	\$0.1817
2054	\$0.1093	\$0.1817
2055	\$0.1093	\$0.1817

<sup>a</sup> Values rounded to 4 significant digits

**Table IV-12 Hydrogen Price (2022\$ per kg)**

Calendar Year	Price
2030	\$6.00
2031	\$5.60
2032	\$5.20
2033	\$4.80
2034	\$4.40
2035 and later	\$4.00

**Table IV-13 Retail Fuel Cost Per Mile for Model Year 2032 Vehicles from Calendar Years 2023 to 2055 for each MOVES Source Type and Regulatory Class by Fuel Type for the Final Standards<sup>a</sup> (cents/mile in 2022\$, 2% discounting)**

MOVES Source Type	Regulatory Class	Diesel	Gasoline	Electricity	CNG	Hydrogen
Other Buses	LHD45	-	44.4	10.3	-	-
	MHD67	36.0	-	15.2	-	-
	HHD8	40.6	-	22.5	47.4	18.7
Transit Bus	LHD45	-	44.0	12.3	-	-
	MHD67	36.1	-	16.1	-	-
	Urban Bus	38.2	-	16.0	43.9	-
School Bus	LHD45	-	31.4	8.4	-	-
	MHD67	28.5	33.4	10.8	-	-
	HHD8	30.0	-	14.6	35.7	-
Refuse Truck	MHD67	38.9	46.5	15.6	-	-
	HHD8	40.5	-	16.9	47.7	-
Single Unit Short-haul Truck	LHD45	19.0	27.5	7.6	-	-
	MHD67	28.4	34.4	13.0	-	-
	HHD8	34.6	-	17.3	41.3	-
Single Unit Long-haul Truck	LHD45	17.8	26.1	7.8	-	-
	MHD67	26.6	32.1	14.3	-	-
	HHD8	32.2	-	20.8	38.8	-
Combination Short-haul Truck	MHD67	37.9	-	40.8	-	37.8
	HHD8	40.3	-	45.7	45.3	39.4
Combination Long-haul Truck	MHD67	37.5	-	50.0	-	33.4
	HHD8	38.3	-	51.1	42.4	34.1

<sup>a</sup> Values rounded to the nearest tenth of a cent; blank values represent cases where a given MOVES source type and regulatory class did not use a specific fuel type.

**Table IV-14 Retail Fuel Cost Per Mile for Model Year 2032 Vehicles from Calendar Year 2032 to 2055 for each MOVES Source Type and Regulatory Class by Fuel Type<sup>a</sup> (cents/mile in 2022\$, 3% discounting)**

MOVES Source Type	Regulatory Class	Diesel	Gasoline	Electricity	CNG	Hydrogen
Other Buses	LHD45	-	38.6	8.9	-	-
	MHD67	31.4	-	13.2	-	-
	HHD8	35.3	-	19.5	41.2	16.3
Transit Bus	LHD45	-	38.4	10.7	-	-
	MHD67	31.5	-	14.0	-	-
	Urban Bus	33.3	-	14.0	38.3	-
School Bus	LHD45	-	27.3	7.3	-	-
	MHD67	24.8	29.1	9.4	-	-
	HHD8	26.1	-	12.7	31.1	-
Refuse Truck	MHD67	34.1	40.7	13.7	-	-
	HHD8	35.5	-	14.8	41.8	-
Single Unit Short-haul Truck	LHD45	16.8	24.4	6.8	-	-
	MHD67	25.2	30.5	11.5	-	-
	HHD8	30.7	-	15.3	36.6	-
Single Unit Long-haul Truck	LHD45	15.9	23.3	6.9	-	-
	MHD67	23.7	28.6	12.8	-	-
	HHD8	28.7	-	18.5	34.6	-
Combination Short-haul Truck	MHD67	33.8	-	36.3	-	33.7
	HHD8	36.0	-	40.7	40.4	35.2
Combination Long-haul Truck	MHD67	33.2	-	44.1	-	29.5
	HHD8	33.8	-	45.0	37.4	30.1

<sup>a</sup> Values rounded to the nearest tenth of a cent; blank values represent cases where a given MOVES source type and regulatory class did not use a specific fuel type.



**Table IV-15 Retail Fuel Cost Per Mile for Model Year 2032 Vehicles from Calendar Year 2032 to 2055 for each MOVES Source Type and Regulatory Class by Fuel Type<sup>a</sup> (cents/mile in 2022\$, 7% discounting)**

MOVES Source Type	Regulatory Class	Diesel	Gasoline	Electricity	CNG	Hydrogen
Other Buses	LHD45	-	23.1	5.3	-	-
	MHD67	18.8	-	7.9	-	-
	HHD8	21.2	-	11.7	24.7	9.8
Transit Bus	LHD45	-	23.2	6.5	-	-
	MHD67	19.1	-	8.5	-	-
	Urban Bus	20.2	-	8.5	23.2	-
School Bus	LHD45	-	16.4	4.4	-	-
	MHD67	14.9	17.4	5.6	-	-
	HHD8	15.6	-	7.6	18.6	-
Refuse Truck	MHD67	21.0	25.0	8.4	-	-
	HHD8	21.8	-	9.1	25.7	-
Single Unit Short-haul Truck	LHD45	10.8	15.6	4.3	-	-
	MHD67	16.1	19.5	7.3	-	-
	HHD8	19.6	-	9.8	23.3	-
Single Unit Long-haul Truck	LHD45	10.3	15.1	4.5	-	-
	MHD67	15.4	18.6	8.3	-	-
	HHD8	18.6	-	12.0	22.4	-
Combination Short-haul Truck	MHD67	22.1	-	23.6	-	22.1
	HHD8	23.5	-	26.5	26.4	23.1
Combination Long-haul Truck	MHD67	20.9	-	27.7	-	18.7
	HHD8	21.3	-	28.3	23.6	19.1

<sup>a</sup> Values rounded to the nearest tenth of a cent; blank values represent cases where a given MOVES source type and regulatory class did not use a specific fuel type.

**BILLING CODE 6560-50-C**

ii. Costs Associated With Diesel Exhaust Fluid

DEF consumption costs in heavy-duty vehicles were estimated in the HD2027 final rule.<sup>930</sup> We are applying the same methodology in this analysis to estimate the total costs of DEF under the final HD GHG Phase 3 standards. Costs associated with DEF are presented in two ways in a similar manner for fuel costs: on an annual basis for aggregate costs of all vehicles and on a per mile basis for a specific model year in each MOVES source type and regulatory class. The annual costs are presented in section IV.E.3 to show the overall DEF costs of the policy case compared to the reference case. The costs on a per mile basis presented here are given as an example what a specific MY vehicle in a given MOVES source type and regulatory class could estimate to pay on a per mile basis based on the VMT and total cost of all DEF used from the first year the vehicle is in operation

until CY 2055. Note that the DEF consumption rates do not change between the policy and reference scenarios, but the total number of miles traveled by vehicles consuming DEF does change between scenarios. Therefore, the DEF costs per mile are intended to allow a vehicle user an estimate typical costs related to DEF usage and the aggregate annual costs show the impacts of the final standards compared and reference case.

An example of cost estimates of DEF on a per mile basis for MY 2032 vehicles is provided in Table IV-16, Table IV-17, and Table IV-18 for 2 percent, 3 percent, and 7 percent discounting, respectively. DEF costs per mile were estimated by first the totaling DEF costs for MY 2032 vehicles by taking the DEF usage for each MOVES source type and regulatory class and multiplying by the DEF price from CY 2032 to CY 2055.<sup>931</sup> Then to calculate the average cost of DEF per mile, the total DEF cost was divided by the total VMT for each MOVES Source Type and regulatory

class of MY 2032 vehicles from CY 2032 to CY 2055. The DEF cost was computed for the final standards case under the potential compliance pathway for each fuel type. Several source types and regulatory classes contain no diesel-fueled ICE vehicles and therefore no DEF consumption costs. Values shown as a dash “-” in Table IV-16, Table IV-17, and Table IV-18 represent cases where a given MOVES source type and regulatory class did not use a specific fuel type. Table IV-16, Table IV-17, and Table IV-18 have values of 0 for gasoline, electricity, CNG and hydrogen as those vehicles do not consume any DEF and therefore do not incur any cost per mile.

The number of diesel vehicles decrease in the final standards case compared to the reference case therefore the total DEF costs for all vehicles are less in final standards case when computed on an annual basis as shown in section IV.E.3.

**BILLING CODE 6560-50-P**

<sup>930</sup> 88 FR 4296, January 24, 2023.

<sup>931</sup> This analysis uses the DEF prices presented in the NCP Technical Support Document (see

“Nonconformance Penalties for On-highway Heavy-duty Diesel Engines: Technical Support Document,” EPA-420-R-12-014) with growth

beyond 2042 projected at the same 1.3 percent rate as noted in the NCP TSD. Note that the DEF prices used update the NCP TSD’s 2011 prices to 2022\$.

**Table IV-16 DEF Cost Per Mile for Model Year 2032 Vehicles from Calendar Year 2032 to 2055 for each MOVES Source Type and Regulatory Class by Fuel Type for the Final Standards<sup>a</sup> (cents/mile in 2022\$, 2% discounting)**

MOVES Source Type	Regulatory Class	Diesel	Gasoline	Electricity	CNG	Hydrogen
Other Buses	LHD45	-	0	0	-	-
	MHD67	2.25	-	0	-	-
	HHD8	2.53	-	0	0	0
Transit Bus	LHD45	-	0	0	-	-
	MHD67	2.24	-	0	-	-
	Urban Bus	2.38	-	0	0	-
School Bus	LHD45	-	0	0	-	-
	MHD67	1.77	0	0	-	-
	HHD8	1.88	-	0	0	-
Refuse Truck	MHD67	2.40	0	0	-	-
	HHD8	2.50	-	0	0	-
Single Unit Short-haul Truck	LHD45	1.16	0	0	-	-
	MHD67	1.73	0	0	-	-
	HHD8	2.11	-	0	0	-
Single Unit Long-haul Truck	LHD45	1.08	0	0	-	-
	MHD67	1.61	0	0	-	-
	HHD8	1.96	-	0	0	-
Combination Short-haul Truck	MHD67	2.30	-	0	-	0
	HHD8	2.43	-	0	0	0
Combination Long-haul Truck	MHD67	2.30	-	0	-	0
	HHD8	2.34	-	0	0	0

<sup>a</sup> Values rounded to the nearest hundredth of a cent; blank values represent cases where a given MOVES source type and regulatory class did not use a specific fuel type.

**Table IV-17 DEF Cost Per Mile for Model Year 2032 Vehicles From Calendar Year 2032 to 2055 for each MOVES Source Type and Regulatory Class by Fuel Type for the Final Standards<sup>a</sup> (cents/mile in 2022\$, 3% discounting)**

MOVES Source Type	Regulatory Class	Diesel	Gasoline	Electricity	CNG	Hydrogen
Other Buses	LHD45	-	0	0	-	-
	MHD67	1.95	-	0	-	-
	HHD8	2.19	-	0	0	0
Transit Bus	LHD45	-	0	0	-	-
	MHD67	1.95	-	0	-	-
	Urban Bus	2.07	-	0	0	-
School Bus	LHD45	-	0	0	-	-
	MHD67	1.54	0	0	-	-
	HHD8	1.63	-	0	0	-
Refuse Truck	MHD67	2.10	0	0	-	-
	HHD8	2.18	-	0	0	-
Single Unit Short-haul Truck	LHD45	1.03	0	0	-	-
	MHD67	1.53	0	0	-	-
	HHD8	1.87	-	0	0	-
Single Unit Long-haul Truck	LHD45	0.96	0	0	-	-
	MHD67	1.43	0	0	-	-
	HHD8	1.74	-	0	0	-
Combination Short-haul Truck	MHD67	2.05	-	0	-	0
	HHD8	2.17	-	0	0	0
Combination Long-haul Truck	MHD67	2.03	-	0	-	0
	HHD8	2.06	-	0	0	0

<sup>a</sup> Values rounded to the nearest hundredth of a cent; blank values (“-”) represent cases where a given MOVES source type and regulatory class did not use a specific fuel type.

**Table IV-18 DEF Cost Per Mile for Model Year 2032 Vehicles During the First 23 Years for each MOVES Source Type and Regulatory Class by Fuel Type the Final Standards<sup>a</sup> (cents/mile in 2022\$, 7% discounting)**

MOVES Source Type	Regulatory Class	Diesel	Gasoline	Electricity	CNG	Hydrogen
Other Buses	LHD45	-	0	0	-	-
	MHD67	1.15	-	0	-	-
	HHD8	1.30	-	0	0	0
Transit Bus	LHD45	-	0	0	-	-
	MHD67	1.17	-	0	-	-
	Urban Bus	1.24	-	0	0	-
School Bus	LHD45	-	0	0	-	-
	MHD67	0.91	0	0	-	-
	HHD8	0.96	-	0	0	-
Refuse Truck	MHD67	1.28	0	0	-	-
	HHD8	1.33	-	0	0	-
Single Unit Short-haul Truck	LHD45	0.65	0	0	-	-
	MHD67	0.97	0	0	-	-
	HHD8	1.18	-	0	0	-
Single Unit Long-haul Truck	LHD45	0.62	0	0	-	-
	MHD67	0.93	0	0	-	-
	HHD8	1.12	-	0	0	-
Combination Short-haul Truck	MHD67	1.32	-	0	-	0
	HHD8	1.40	-	0	0	0
Combination Long-haul Truck	MHD67	1.26	-	0	-	0
	HHD8	1.29	-	0	0	0

<sup>a</sup> Values rounded to the hundredth tenth of a cent; blank values “-” represent cases where a given MOVES source type and regulatory class did not use a specific fuel type and represent cases where there was no DEF consumed.

iii. Costs Associated With Maintenance and Repair

We assessed the estimated maintenance and repair costs of HD ICE vehicles, BEVs and FCEVs for the reference case and the final standards case under the potential compliance pathway. After consideration of comments, we have reduced the maintenance and repair costs for vocational ICE vehicles in the final rule. This change led to a decrease in the M&R costs of the BEVs and FCEVs accordingly. We made further changes to M&R costs for BEVs and FCEVs in the early years of the Phase 3 program such

that the M&R savings do not accrue as quickly as they did in our NPRM analysis. The results of our analysis show that maintenance and repair costs associated with HD BEVs and FCEVs are estimated to be lower than maintenance and repair costs associated with comparable ICE vehicles. The methodology for how we calculated maintenance and repair costs were estimated is discussed in RIA Chapter 2.3.4.2, 2.4.4.1, 2.5.3.2 and Chapter 3 of the RIA.

Maintenance and repair cost in cents per mile were computed in a similar manner as fuel and DEF costs. The cost of maintenance and repairs in cents per

mile for MY 2032 vehicles in each MOVES source type and regulatory class by fuel type for the final standards are shown in Table IV-19, Table IV-20, and Table IV-21 for 2-percent, 3-percent and 7-percent discount rates, respectively. Table IV-19, Table IV-20, and Table IV-21 demonstrate higher costs per mile of ICE vehicles compared to ZEV. The number of ICE vehicles decrease and ZEV increase in the final standards case compared to the reference case therefore the total maintenance and repair costs for all vehicles are less in final standards case when computed on an annual basis as shown in section IV.E.3.

**Table IV-19 Maintenance and Repair Per Mile for Model Year 2032 Vehicles from Calendar Year 2032 to 2055 for each MOVES Source Type and Regulatory Class by Fuel Type for the Final Standards<sup>a</sup> (cents/mile in 2022\$, 2% discounting)**

MOVES Source Type	Regulatory Class	Diesel	Gasoline	Electricity	CNG	Hydrogen
Other Buses	LHD45	-	30.5	21.6	-	-
	MHD67	30.5	-	21.6	-	-
	HHD8	30.5	-	21.6	30.5	23.1
Transit Bus	LHD45	-	29.9	21.2	-	-
	MHD67	29.9	-	21.2	-	-
	Urban Bus	29.9	-	21.2	29.9	-
School Bus	LHD45	-	30.5	21.7	-	-
	MHD67	30.5	30.5	21.7	-	-
	HHD8	30.5	-	21.7	30.5	-
Refuse Truck	MHD67	29.0	29.0	20.6	-	-
	HHD8	29.0	-	20.6	29.0	-
Single Unit Short-haul Truck	LHD45	26.6	26.6	18.9	-	-
	MHD67	26.6	26.6	18.9	-	-
	HHD8	26.6	-	18.9	26.6	-
Single Unit Long-haul Truck	LHD45	25.5	25.5	18.1	-	-
	MHD67	25.5	25.5	18.1	-	-
	HHD8	25.5	-	18.1	25.5	-
Combination Short-haul Truck	MHD67	25.2	-	17.9	-	19.3
	HHD8	25.2	-	17.9	25.2	19.3
Combination Long-haul Truck	MHD67	27.5	-	19.5	-	20.9
	HHD8	27.5	-	19.5	27.5	20.9

<sup>a</sup> Values rounded to the nearest tenth of a cent; blank values represent cases where a given MOVES source type and regulatory class did not use a specific fuel type.

**Table IV-20 Maintenance and Repair Per Mile for Model Year 2032 Vehicles from Calendar Year 2032 to 2055 for each MOVES Source Type and Regulatory Class by Fuel Type for the Final Standards<sup>a</sup> (cents/mile in 2022\$, 3% discounting)**

MOVES Source Type	Regulatory Class	Diesel	Gasoline	Electricity	CNG	Hydrogen
Other Buses	LHD45	-	25.7	18.3	-	-
	MHD67	25.7	-	18.3	-	-
	HHD8	25.7	-	18.3	25.7	19.5
Transit Bus	LHD45	-	25.3	18.0	-	-
	MHD67	25.3	-	18.0	-	-
	Urban Bus	25.3	-	18.0	25.3	-
School Bus	LHD45	-	25.7	18.3	-	-
	MHD67	25.7	25.7	18.3	-	-
	HHD8	25.7	-	18.3	25.7	-
Refuse Truck	MHD67	24.7	24.7	17.5	-	-
	HHD8	24.7	-	17.5	24.7	-
Single Unit Short-haul Truck	LHD45	23.0	23.0	16.3	-	-
	MHD67	23.0	23.0	16.3	-	-
	HHD8	23.0	-	16.3	23.0	-
Single Unit Long-haul Truck	LHD45	22.2	22.2	15.8	-	-
	MHD67	22.2	22.2	15.8	-	-
	HHD8	22.2	-	15.8	22.2	-
Combination Short-haul Truck	MHD67	22.0	-	15.6	-	16.8
	HHD8	22.0	-	15.6	22.0	16.8
Combination Long-haul Truck	MHD67	23.6	-	16.8	-	18.0
	HHD8	23.6	-	16.8	23.6	18.0

<sup>a</sup> Values rounded to the nearest tenth of a cent; blank values (“-”) represent cases where a given MOVES source type and regulatory class did not use a specific fuel type.

**Table IV-21 Maintenance and Repair Per Mile for Model Year 2032 Vehicles from Calendar Year 2032 to 2055 for each MOVES Source Type and Regulatory Class by Fuel Type for the Final Standards<sup>a</sup> (cents/mile in 2022\$, 7% discounting)**

MOVES Source Type	Regulatory Class	Diesel	Gasoline	Electricity	CNG	Hydrogen
Other Buses	LHD45	-	13.7	9.7	-	-
	MHD67	13.7	-	9.7	-	-
	HHD8	13.7	-	9.7	13.7	10.4
Transit Bus	LHD45	-	13.6	9.7	-	-
	MHD67	13.6	-	9.7	-	-
	Urban Bus	13.6	-	9.7	13.6	-
School Bus	LHD45	-	13.7	9.7	-	-
	MHD67	13.7	13.7	9.7	-	-
	HHD8	13.7	-	9.7	13.7	-
Refuse Truck	MHD67	13.7	13.7	9.7	-	-
	HHD8	13.7	-	9.7	13.7	-
Single Unit Short-haul Truck	LHD45	13.4	13.4	9.5	-	-
	MHD67	13.4	13.4	9.5	-	-
	HHD8	13.4	-	9.5	13.4	-
Single Unit Long-haul Truck	LHD45	13.2	13.2	9.4	-	-
	MHD67	13.2	13.2	9.4	-	-
	HHD8	13.2	-	9.4	13.2	-
Combination Short-haul Truck	MHD67	13.2	-	9.4	-	10.2
	HHD8	13.2	-	9.4	13.2	10.2
Combination Long-haul Truck	MHD67	13.5	-	9.6	-	10.3
	HHD8	13.5	-	9.6	13.5	10.3

<sup>a</sup> Values rounded to the nearest tenth of a cent; blank values (“-”) represent cases where a given MOVES source type and regulatory class did not use a specific fuel type.

iv. Costs Associated With Insurance

As discussed in preamble section II.E.5, we did not take into account the cost of insurance on the user in the NPRM. A few commenters suggested we should consider the addition of insurance cost because the incremental cost of insurance for the ZEVs will be higher than for ICE vehicles. We agree that insurance costs may differ between vehicles, and this is a cost that will be

seen by the operator. Therefore, for the final rule analysis, we included the incremental insurance costs of a ZEV relative to a comparable ICE vehicle under the potential compliance pathway by incorporating an annual insurance cost equal to 3 percent of initial upfront vehicle technology RPE cost, as described in section II.E.5 of the preamble. This annual cost was applied for each operating year of the vehicle.

To calculate the year over year insurance costs, 3 percent of the initial vehicle technology package RPE was multiplied by estimated sales for the final standards and reference case and were computed each year a vehicle was operational. Then the difference between the final standards case and reference case insurance costs are shown on an annual basis in Table IV-22.

**Table IV-22 Annual Insurance Costs for the Final Standards Relative to the Reference Case, Millions of 2022\$<sup>a</sup>**

Calendar Year	Insurance
2027	-\$1.1
2028	-\$5.4
2029	-\$14
2030	-\$18
2031	-\$23
2032	-\$20
2033	-\$11
2034	-\$3.3
2035	\$1.8
2036	\$2.7
2037	\$3.4
2038	-\$1.4
2039	-\$7.7
2040	-\$15
2041	-\$26
2042	-\$38
2043	-\$49
2044	-\$63
2045	-\$78
2046	-\$93
2047	-\$110
2048	-\$130
2049	-\$140
2050	-\$160
2051	-\$180
2052	-\$190
2053	-\$210
2054	-\$230
2055	-\$250
PV, 2%	-\$1,300
PV, 3%	-\$1,000
PV, 7%	-\$460
AV, 2%	-\$60
AV, 3%	-\$55
AV, 7%	-\$38

<sup>a</sup> Values show 2 significant digits; negative values denote lower costs, i.e., savings in expenditures.

v. Costs Associated With State Registration Fees on ZEVs

As discussed in preamble section II.E.5, we did not take into account the cost of state registration fees on ZEVs in the NPRM. Commenters suggested we should consider the addition of state registration fees on ZEVs because some states have adopted state ZEV

registration fees in some cases to replace gasoline and diesel road tax revenue. Currently, many states do not have any additional registration fee for EVs. For the states that do, the registration fees are generally between \$50 and \$225 per year. While EPA cannot predict whether and to what extent other states will enact EV registration fees, we have nonetheless conservatively added an

annual additional registration fee to all ZEV vehicles of \$100 in our cost analysis. This annual cost was applied for each operating year of the vehicle. Then the difference between the final standards case and reference case for state registration fees on BEVs costs are shown on an annual basis in Table IV-23.

**Table IV-23 Annual State Registration Fees on ZEVs Costs for the Final Standards Relative to the Reference Case, Millions of 2022\$<sup>a</sup>**

Calendar Year	State Registration Fees on ZEVs
2027	\$2.6
2028	\$5.6
2029	\$8.9
2030	\$13
2031	\$22
2032	\$36
2033	\$49
2034	\$62
2035	\$74
2036	\$85
2037	\$97
2038	\$110
2039	\$120
2040	\$130
2041	\$140
2042	\$150
2043	\$160
2044	\$160
2045	\$170
2046	\$180
2047	\$190
2048	\$190
2049	\$200
2050	\$210
2051	\$210
2052	\$220
2053	\$220
2054	\$220
2055	\$230
PV, 2%	\$2,500
PV, 3%	\$2,100
PV, 7%	\$1,000
AV, 2%	\$110
AV, 3%	\$110
AV, 7%	\$85

<sup>a</sup> Values show 2 significant digits.

vi. Costs Associated With Battery Replacement and Engine Rebuild

As discussed in preamble section II.E.6, we did not take into account the cost of battery replacement and engine rebuild on the user in the NPRM. In the

final rule, after consideration of comment, we added battery replacement and engine rebuild costs. Table IV-24 shows the annual estimated battery replacement and engine rebuild costs on an annual basis relative to the reference case under the potential compliance

pathway. Battery replacement and engine rebuild frequency and costs depend on MOVES vehicle source type and regulatory class. Details about the year of replacement or rebuild and associated costs are discussed in RIA 3.<sup>932</sup>

<sup>932</sup> Sanchez, James. Memorandum to docket EPA-HQ-OAR-2022-0985. "Estimating Battery

Replacement and Engine Rebuild Costs". February 23, 2023.



**Table IV-24 Battery Replacement and Engine Rebuild Costs for the Final Standards Relative to the Reference Case, Millions of 2022\$<sup>a</sup>**

Calendar Year	Battery Replacement and Engine Rebuild
2027	\$0
2028	\$0
2029	\$0
2030	\$0
2031	\$0
2032	\$0
2033	\$0
2034	\$0
2035	\$0
2036	\$0
2037	-\$3.7
2038	-\$2.9
2039	-\$22
2040	-\$47
2041	-\$98
2042	-\$210
2043	-\$370
2044	-\$340
2045	-\$270
2046	-\$150
2047	-\$150
2048	-\$150
2049	-\$150
2050	-\$150
2051	-\$150
2052	-\$150
2053	-\$150
2054	-\$150
2055	-\$140
PV, 2%	-\$1,900
PV, 3%	-\$1,500
PV, 7%	-\$720
AV, 2%	-\$86
AV, 3%	-\$80
AV, 7%	-\$58

<sup>a</sup> Values show 2 significant digits; negative values denote lower costs, i.e., savings in expenditures.

vii. Costs Associated With EVSE Replacement

As discussed in preamble section II.E.6, we did not take into account the cost of EVSE replacement on the user in the NPRM. In the final rule, after consideration of comment, we added EVSE replacement. There is limited data

on the expected lifespan of charging infrastructure. We make the simplifying assumption that all depot EVSE ports have a 15-year equipment lifetime.<sup>933</sup> After that, we assume they must be replaced at full cost. This assumption likely overestimates costs as some EVSE providers may opt to upgrade existing equipment rather than incur the cost of

a full replacement. Some installation costs such as trenching or electrical upgrades may also not be needed for the replacement. Table IV-25 shows the annual estimated EVSE replacement costs on annual basis relative to the reference case under the potential compliance pathway.

<sup>933</sup> Borlaug, B., Salisbury, S., Gerdes, M., and Muratori, M. "Levelized Cost of Charging Electric

Vehicles in the United States," 2020. Available

online: <https://www.sciencedirect.com/science/article/pii/S2542435120302312?via%3Dihub>.

**Table IV-25 EVSE Replacement Costs for the Final Standards Relative to the Reference Case, Millions of 2022\$<sup>a</sup>**

Calendar Year	EVSE Replacement
2027	\$0
2028	\$0
2029	\$0
2030	\$0
2031	\$0
2032	\$0
2033	\$0
2034	\$0
2035	\$0
2036	\$0
2037	\$0
2038	\$0
2039	\$0
2040	\$0
2041	\$370
2042	\$520
2043	\$610
2044	\$530
2045	\$1,100
2046	\$1,700
2047	\$1,600
2048	\$1,500
2049	\$1,300
2050	\$1,300
2051	\$1,300
2052	\$1,300
2053	\$1,300
2054	\$1,300
2055	\$1,300
PV, 2%	\$11,000
PV, 3%	\$8,700
PV, 7%	\$3,700
AV, 2%	\$500
AV, 3%	\$450
AV, 7%	\$300

<sup>a</sup> Values show 2 significant digits.

**E. Social Costs**

To compute the social costs of the final rulemaking, we added the estimated total vehicle technology package RPE from section IV.B.3, total operating costs from section IV.D.7, and total EVSE RPE from section IV.D.3. We note that the fuel costs in this subsection’s social cost analysis are estimated pre-tax rather than what the purchaser will pay (*i.e.*, the retail fuel

price). All of the costs are computed for the MOVES reference and final standards cases and cost impacts are presented as the difference between the final standards and reference case. Additionally, the battery tax credit, vehicle tax credit, EVSE tax credit, excise taxes, sales taxes, and state registration fees on ZEVs are not included in the social costs analysis discussed in this subsection.

**1. Total Vehicle Technology Package RPE**

Table IV-26 reflects learning effects on DMC and indirect costs from 2027 through 2055. The sum of the DMC and indirect manufacturing cost for each year is shown in the “Total Technology Package Costs” column and reflects the difference in total cost between the final standards and reference case in the specific calendar year.

**Table IV-26 Total Technology Cost Impacts of the Final Standards Relative to the Reference Case, All Regulatory Classes and All Fuels, Millions of 2022\$<sup>a</sup>**

Calendar Year	Direct Manufacturing Costs	Indirect Costs	Total Technology Package Costs
2027	\$21	\$9	\$30
2028	-\$9.7	-\$4.1	-\$14
2029	-\$60	-\$25	-\$85
2030	\$120	\$49	\$160
2031	\$190	\$79	\$270
2032	\$340	\$140	\$480
2033	\$220	\$91	\$310
2034	\$180	\$76	\$260
2035	\$110	\$47	\$160
2036	\$16	\$6.8	\$23
2037	-\$18	-\$7.5	-\$25
2038	-\$98	-\$41	-\$140
2039	-\$160	-\$69	-\$230
2040	-\$180	-\$76	-\$260
2041	-\$230	-\$98	-\$330
2042	-\$290	-\$120	-\$400
2043	-\$280	-\$120	-\$390
2044	-\$320	-\$130	-\$450
2045	-\$360	-\$150	-\$510
2046	-\$350	-\$150	-\$490
2047	-\$370	-\$160	-\$530
2048	-\$390	-\$170	-\$560
2049	-\$420	-\$180	-\$590
2050	-\$400	-\$170	-\$570
2051	-\$420	-\$180	-\$590
2052	-\$440	-\$180	-\$620
2053	-\$450	-\$190	-\$640
2054	-\$430	-\$180	-\$610
2055	-\$420	-\$170	-\$590
PV, 2%	-\$2,900	-\$1,200	-\$4,200
PV, 3%	-\$2,300	-\$950	-\$3,200
PV, 7%	-\$720	-\$300	-\$1,000
AV, 2%	-\$130	-\$56	-\$190
AV, 3%	-\$120	-\$49	-\$170
AV, 7%	-\$59	-\$25	-\$83

<sup>a</sup> Values show 2 significant digits; negative values denote lower costs, i.e., savings in expenditures.

2. Total EVSE RPE

Building on the analysis presented in section IV.D.3 that discusses EVSE RPE cost per vehicle for depot charging, the annual EVSE RPE was estimated by multiplying EVSE RPE on a per vehicle

basis by the modeled number of BEV sales in MOVES. Table IV-27 shows the undiscounted annual EVSE RPE cost for the final standards relative to the reference case. The number of EVSE are expected to increase over time for the final standards relative to the reference

case. This is due to the expected increase in BEVs requiring EVSE in our modeled potential compliance pathway's technology packages. Thus, our modeled compliance pathway for the final standards shows increased EVSE cost over time.

**Table IV-27 Total EVSE RPE Cost Impacts of the Final Standards Relative to the Reference Case, All Regulatory Classes and All Fuels, Millions of 2022\$<sup>a</sup>**

Calendar Year	Total EVSE RPE Cost Impacts
2027	\$440
2028	\$610
2029	\$730
2030	\$630
2031	\$1,300
2032	\$2,000
2033	\$1,900
2034	\$1,700
2035	\$1,600
2036	\$1,600
2037	\$1,500
2038	\$1,500
2039	\$1,500
2040	\$1,500
2041	\$1,500
2042	\$1,400
2043	\$1,400
2044	\$1,400
2045	\$1,400
2046	\$1,300
2047	\$1,300
2048	\$1,300
2049	\$1,300
2050	\$1,200
2051	\$1,200
2052	\$1,200
2053	\$1,200
2054	\$1,200
2055	\$1,100
PV, 2%	\$28,000
PV, 3%	\$25,000
PV, 7%	\$15,000
AV, 2%	\$1,300
AV, 3%	\$1,300
AV, 7%	\$1,300

<sup>a</sup> Values show 2 significant digits.

3. Total Operating Costs

EPA computed annual fuel costs across the national fleet for each fuel type for the final standards and reference cases by multiplying the amount of fuel consumed for each vehicle modeled in MOVES by the cost of each fuel type. Table IV-28 shows the undiscounted annual fuel savings for

the final standards relative to the reference case for each fuel type. Using projected fuel prices from AEO 2023 and the estimated electricity and hydrogen prices as discussed in section IV.D.7.i, the total, national fleet-wide costs of electricity and hydrogen consumption increase over time while the costs for diesel, gasoline, and CNG consumption decrease over time, as

shown on an annual basis in Table IV-28. This is due to the expected increase in BEVs and FCEVs in our modeled potential compliance pathway resulting in fewer diesel, gasoline, and CNG vehicles in the final standards case compared to the reference case. The net effect of the final standards shows increased operating cost savings over time.

**Table IV-28 Annual Undiscounted Pre-Tax Fuel Costs for the Final Standards Relative to the Reference Case, Millions of 2022\$<sup>a</sup>**

Calendar Year	Diesel	Gasoline	CNG	Electricity	Hydrogen	Sum
2027	-\$100	-\$59	\$0	\$76	\$0	-\$84
2028	-\$260	-\$110	-\$2	\$200	\$0	-\$170
2029	-\$480	-\$170	-\$3	\$370	\$0	-\$280
2030	-\$930	-\$220	-\$6	\$880	\$100	-\$170
2031	-\$1,900	-\$350	-\$11	\$1,900	\$290	-\$110
2032	-\$3,800	-\$560	-\$20	\$3,700	\$650	\$37
2033	-\$5,600	-\$760	-\$29	\$5,500	\$970	\$120
2034	-\$7,400	-\$930	-\$38	\$7,300	\$1,200	\$170
2035	-\$9,200	-\$1,100	-\$47	\$9,100	\$1,400	\$160
2036	-\$11,000	-\$1,200	-\$57	\$11,000	\$1,700	\$350
2037	-\$12,000	-\$1,300	-\$66	\$12,000	\$2,000	\$490
2038	-\$14,000	-\$1,400	-\$76	\$14,000	\$2,300	\$640
2039	-\$15,000	-\$1,500	-\$85	\$15,000	\$2,500	\$810
2040	-\$16,000	-\$1,600	-\$95	\$16,000	\$2,700	\$980
2041	-\$17,000	-\$1,700	-\$100	\$17,000	\$2,900	\$990
2042	-\$18,000	-\$1,800	-\$110	\$18,000	\$3,100	\$1,100
2043	-\$19,000	-\$1,800	-\$120	\$19,000	\$3,300	\$1,100
2044	-\$19,000	-\$1,800	-\$130	\$19,000	\$3,400	\$1,200
2045	-\$20,000	-\$1,900	-\$140	\$20,000	\$3,500	\$1,200
2046	-\$20,000	-\$1,900	-\$150	\$20,000	\$3,600	\$880
2047	-\$21,000	-\$1,900	-\$160	\$20,000	\$3,700	\$800
2048	-\$21,000	-\$2,000	-\$170	\$20,000	\$3,700	\$670
2049	-\$21,000	-\$2,000	-\$180	\$20,000	\$3,800	\$540
2050	-\$21,000	-\$2,000	-\$190	\$20,000	\$3,800	\$430
2051	-\$21,000	-\$2,000	-\$210	\$20,000	\$3,900	\$420
2052	-\$21,000	-\$2,000	-\$220	\$20,000	\$3,900	\$410
2053	-\$22,000	-\$2,100	-\$230	\$20,000	\$4,000	\$390
2054	-\$22,000	-\$2,100	-\$240	\$20,000	\$4,000	\$370
2055	-\$22,000	-\$2,100	-\$260	\$20,000	\$4,000	\$350

<sup>a</sup> Values rounded to two significant digits; negative values denote lower costs, i.e., savings in expenditures.

Annual DEF costs for diesel vehicles were computed for the final standards and reference cases by multiplying the modeled amount of DEF consumed by

the cost DEF. Table IV-29 shows the annual savings associated with less DEF consumption in the final standards relative to the reference case; note that

non-diesel vehicles are shown for completeness with no savings since those vehicles do not consume DEF.

**Table IV-29 Annual Undiscounted DEF Costs for the Final Standards Relative to the Reference Case, Millions of 2022\$<sup>a</sup>**

Calendar Year	Diesel	Gasoline, CNG, Electric, Hydrogen Vehicles	Sum
2027	-\$6	\$0	-\$6
2028	-\$17	\$0	-\$17
2029	-\$32	\$0	-\$32
2030	-\$61	\$0	-\$61
2031	-\$130	\$0	-\$130
2032	-\$250	\$0	-\$250
2033	-\$380	\$0	-\$380
2034	-\$500	\$0	-\$500
2035	-\$630	\$0	-\$630
2036	-\$740	\$0	-\$740
2037	-\$860	\$0	-\$860
2038	-\$960	\$0	-\$960
2039	-\$1,100	\$0	-\$1,100
2040	-\$1,200	\$0	-\$1,200
2041	-\$1,200	\$0	-\$1,200
2042	-\$1,300	\$0	-\$1,300
2043	-\$1,400	\$0	-\$1,400
2044	-\$1,400	\$0	-\$1,400
2045	-\$1,500	\$0	-\$1,500
2046	-\$1,500	\$0	-\$1,500
2047	-\$1,600	\$0	-\$1,600
2048	-\$1,600	\$0	-\$1,600
2049	-\$1,600	\$0	-\$1,600
2050	-\$1,700	\$0	-\$1,700
2051	-\$1,700	\$0	-\$1,700
2052	-\$1,700	\$0	-\$1,700
2053	-\$1,800	\$0	-\$1,800
2054	-\$1,800	\$0	-\$1,800
2055	-\$1,800	\$0	-\$1,800

<sup>a</sup> Values rounded to two significant digits; negative values denote lower costs, i.e., savings in expenditures.

EPA computed annual maintenance and repair costs on an annual basis for all vehicles modeled in MOVES based on the total annual VMT, vehicle type and vehicle age as discussed in preamble section V and RIA Chapters 2 and 3. Table IV-30 presents the maintenance and repair costs associated with the final rulemaking. The maintenance and repair costs are

attributable to changes in new BEV, FCEV, and ICE vehicle sales and populations. EPA has not projected any changes to the maintenance and repair costs on a per mile basis for each vehicle powertrain type between the final standards and reference case, but as more HD ZEVs enter the HD fleet in our modeled potential compliance pathway, the total maintenance and

repair costs for the fleet of those vehicles correspondingly increases. The opposite is true for diesel, gasoline, and CNG vehicles in that potential compliance pathway as there become fewer of these vehicles in the fleet, such that their total maintenance and repair costs decrease.

**Table IV-30 Annual Undiscounted Maintenance & Repair Costs for the Final Standards Relative to the Reference Case, Millions of 2022\$<sup>a</sup>**

Calendar Year	Diesel	Gasoline	CNG	Electricity	Hydrogen	Sum
2027	-\$49	-\$23	\$0	\$63	\$0	-\$9
2028	-\$130	-\$51	\$0	\$160	\$0	-\$28
2029	-\$250	-\$84	-\$1	\$280	\$0	-\$64
2030	-\$480	-\$120	-\$2	\$450	\$24	-\$130
2031	-\$950	-\$190	-\$4	\$790	\$76	-\$280
2032	-\$1,800	-\$310	-\$7	\$1,400	\$190	-\$580
2033	-\$2,800	-\$440	-\$11	\$2,100	\$310	-\$900
2034	-\$4,000	-\$570	-\$15	\$2,900	\$450	-\$1,300
2035	-\$5,300	-\$710	-\$21	\$3,800	\$580	-\$1,700
2036	-\$6,700	-\$850	-\$26	\$4,700	\$750	-\$2,200
2037	-\$8,100	-\$990	-\$32	\$5,600	\$940	-\$2,600
2038	-\$9,500	-\$1,100	-\$39	\$6,500	\$1,100	-\$3,000
2039	-\$11,000	-\$1,300	-\$46	\$7,400	\$1,300	-\$3,400
2040	-\$12,000	-\$1,400	-\$53	\$8,200	\$1,500	-\$3,900
2041	-\$13,000	-\$1,500	-\$60	\$9,100	\$1,700	-\$4,300
2042	-\$15,000	-\$1,600	-\$67	\$9,800	\$1,800	-\$4,600
2043	-\$16,000	-\$1,700	-\$75	\$11,000	\$2,000	-\$5,000
2044	-\$17,000	-\$1,800	-\$82	\$11,000	\$2,200	-\$5,300
2045	-\$17,000	-\$1,800	-\$90	\$12,000	\$2,300	-\$5,500
2046	-\$18,000	-\$1,900	-\$97	\$12,000	\$2,400	-\$5,700
2047	-\$19,000	-\$2,000	-\$100	\$12,000	\$2,500	-\$5,900
2048	-\$19,000	-\$2,000	-\$110	\$13,000	\$2,600	-\$6,100
2049	-\$20,000	-\$2,000	-\$120	\$13,000	\$2,700	-\$6,200
2050	-\$20,000	-\$2,100	-\$130	\$13,000	\$2,800	-\$6,400
2051	-\$21,000	-\$2,100	-\$140	\$14,000	\$2,900	-\$6,500
2052	-\$21,000	-\$2,200	-\$150	\$14,000	\$2,900	-\$6,600
2053	-\$21,000	-\$2,200	-\$150	\$14,000	\$3,000	-\$6,700
2054	-\$22,000	-\$2,200	-\$160	\$14,000	\$3,100	-\$6,800
2055	-\$22,000	-\$2,200	-\$170	\$14,000	\$3,100	-\$6,900

<sup>a</sup> Values rounded to two significant digits; negative values denote lower costs, i.e., savings in expenditures.

Annual insurance costs were computed by EPA on an annual basis for all vehicles modeled in MOVES based on the purchaser RPE, as discussed RIA Chapter 2 and 3. Table IV-31 presents the insurance costs associated with the final rulemaking. The insurance costs are attributable to changes in new BEV,

FCEV, and ICE vehicle sales and populations in our modeled potential compliance pathway. EPA has not projected any changes to the insurance for each vehicle powertrain type between the final standards and reference case, but as more HD ZEVs enter the HD fleet, the total insurance

costs for the fleet of those vehicles correspondingly increases. The opposite is true for diesel, gasoline, and CNG vehicles in our modeled potential compliance pathway as there become fewer of these vehicles in the fleet, such that the total insurance costs for the fleet of those vehicles decreases.

**Table IV-31 Annual Undiscounted Insurance Costs for the Final Standards Relative to the Reference Case, Millions of 2022\$<sup>a</sup>**

Calendar Year	Diesel	Gasoline	CNG	Electricity	Hydrogen	Sum
2027	\$0	\$0	\$0	-\$1	\$0	-\$1
2028	\$0	\$0	\$0	-\$5	\$0	-\$5
2029	\$0	\$0	\$0	-\$14	\$0	-\$14
2030	\$0	\$0	\$0	-\$21	\$3	-\$18
2031	\$0	\$0	\$0	-\$32	\$8	-\$23
2032	\$0	\$0	\$0	-\$40	\$20	-\$20
2033	\$0	\$0	\$0	-\$41	\$30	-\$11
2034	\$0	\$0	\$0	-\$44	\$41	-\$3
2035	\$0	\$0	\$0	-\$48	\$50	\$2
2036	\$0	\$0	\$0	-\$56	\$59	\$3
2037	\$0	\$0	\$0	-\$65	\$68	\$3
2038	\$0	\$0	\$0	-\$77	\$76	-\$1
2039	\$0	\$0	\$0	-\$90	\$83	-\$8
2040	\$0	\$0	\$0	-\$100	\$89	-\$15
2041	\$0	\$0	\$0	-\$120	\$95	-\$26
2042	\$0	\$0	\$0	-\$140	\$100	-\$38
2043	\$0	\$0	\$0	-\$150	\$110	-\$49
2044	\$0	\$0	\$0	-\$170	\$110	-\$63
2045	\$0	\$0	\$0	-\$190	\$110	-\$78
2046	\$0	\$0	\$0	-\$210	\$120	-\$93
2047	\$0	\$0	\$0	-\$230	\$120	-\$110
2048	\$0	\$0	\$0	-\$250	\$120	-\$130
2049	\$0	\$0	\$0	-\$270	\$130	-\$140
2050	\$0	\$0	\$0	-\$290	\$130	-\$160
2051	\$0	\$0	\$0	-\$310	\$130	-\$180
2052	\$0	\$0	\$0	-\$330	\$130	-\$190
2053	\$0	\$0	\$0	-\$350	\$130	-\$210
2054	\$0	\$0	\$0	-\$360	\$130	-\$230
2055	\$0	\$0	\$0	-\$380	\$130	-\$250

<sup>a</sup> Values rounded to two significant digits; negative values denote lower costs, i.e., savings in expenditures.

Battery replacement and engine rebuild costs were computed on an annual basis for select BEV vehicles modeled in MOVES in the year a BEV/FCEV reaches its replacement age, as discussed in RIA Chapter 2 and 3. The battery replacement costs are attributable to changes in BEV age and

populations under the modeled potential compliance pathway. EPA has not projected any changes to the battery replacement costs for each vehicle powertrain type between the final standards and reference case, but as more HD ZEVs enter the HD fleet, the total battery replacement costs for the

fleet of those vehicles correspondingly increases. Similarly, ICE engine rebuild costs are applied to ICE vehicles once the vehicle reaches its replacement age. Table IV-32 presents the battery replacement and engine rebuild costs associated with the final rulemaking.



**Table IV-32 Annual Undiscounted Battery Replacement and Engine Rebuild Costs for the Final Standards Relative to the Reference Case, Millions of 2022\$<sup>a</sup>**

Calendar Year	Diesel	Gasoline	CNG	Electricity	Hydrogen	Sum
2027	\$0	\$0	\$0	\$0	\$0	\$0
2028	\$0	\$0	\$0	\$0	\$0	\$0
2029	\$0	\$0	\$0	\$0	\$0	\$0
2030	\$0	\$0	\$0	\$0	\$0	\$0
2031	\$0	\$0	\$0	\$0	\$0	\$0
2032	\$0	\$0	\$0	\$0	\$0	\$0
2033	\$0	\$0	\$0	\$0	\$0	\$0
2034	\$0	\$0	\$0	\$0	\$0	\$0
2035	\$0	\$0	\$0	\$0	\$0	\$0
2036	\$0	\$0	\$0	\$0	\$0	\$0
2037	\$0	-\$4	\$0	\$0	\$0	-\$4
2038	\$0	-\$3	\$0	\$0	\$0	-\$3
2039	-\$20	-\$2	\$0	\$0	\$0	-\$22
2040	-\$46	-\$1	\$0	\$0	\$0	-\$47
2041	-\$97	-\$9	\$0	\$8	\$0	-\$98
2042	-\$210	-\$16	-\$1	\$17	\$0	-\$210
2043	-\$380	-\$14	-\$1	\$22	\$0	-\$370
2044	-\$390	-\$12	-\$1	\$59	\$0	-\$340
2045	-\$400	-\$10	-\$1	\$130	\$0	-\$270
2046	-\$400	-\$10	-\$1	\$260	\$0	-\$150
2047	-\$390	-\$10	-\$2	\$260	\$0	-\$150
2048	-\$390	-\$10	-\$2	\$260	\$0	-\$150
2049	-\$390	-\$9	-\$2	\$250	\$0	-\$150
2050	-\$390	-\$9	-\$2	\$250	\$0	-\$150
2051	-\$390	-\$9	-\$2	\$250	\$0	-\$150
2052	-\$390	-\$9	-\$2	\$250	\$0	-\$150
2053	-\$390	-\$9	-\$2	\$250	\$0	-\$150
2054	-\$380	-\$8	-\$2	\$250	\$0	-\$150
2055	-\$380	-\$8	-\$2	\$250	\$0	-\$140

<sup>a</sup> Values rounded to two significant digits; negative values denote lower costs, i.e., savings in expenditures.

EVSE replacement costs were computed on an annual basis for all BEV modeled in MOVES in the year an EVSE reaches its replacement age, as discussed in RIA Chapter 2 and 3. The EVSE replacement costs are attributable to changes in BEV populations under

the modeled potential compliance pathway. EPA has not projected any changes to a single EVSE replacement cost between the final standards and reference case, but as more HD ZEVs enter the HD fleet, the total number of EVSE increases. For this reason, there

will be more EVSE to replace in the final standards compared to the reference case. Table IV-33 presents the EVSE replacement costs associated with the final rulemaking.

**Table IV-33 Annual Undiscounted EVSE Replacement Costs for the Final Standards Relative to the Reference Case, Millions of 2022\$<sup>a</sup>**

Calendar Year	Diesel	Gasoline	CNG	Electricity	Hydrogen	Sum
2027	\$0	\$0	\$0	\$0	\$0	\$0
2028	\$0	\$0	\$0	\$0	\$0	\$0
2029	\$0	\$0	\$0	\$0	\$0	\$0
2030	\$0	\$0	\$0	\$0	\$0	\$0
2031	\$0	\$0	\$0	\$0	\$0	\$0
2032	\$0	\$0	\$0	\$0	\$0	\$0
2033	\$0	\$0	\$0	\$0	\$0	\$0
2034	\$0	\$0	\$0	\$0	\$0	\$0
2035	\$0	\$0	\$0	\$0	\$0	\$0
2036	\$0	\$0	\$0	\$0	\$0	\$0
2037	\$0	\$0	\$0	\$0	\$0	\$0
2038	\$0	\$0	\$0	\$0	\$0	\$0
2039	\$0	\$0	\$0	\$0	\$0	\$0
2040	\$0	\$0	\$0	\$0	\$0	\$0
2041	\$0	\$0	\$0	\$370	\$0	\$370
2042	\$0	\$0	\$0	\$520	\$0	\$520
2043	\$0	\$0	\$0	\$610	\$0	\$610
2044	\$0	\$0	\$0	\$530	\$0	\$530
2045	\$0	\$0	\$0	\$1,100	\$0	\$1,100
2046	\$0	\$0	\$0	\$1,700	\$0	\$1,700
2047	\$0	\$0	\$0	\$1,600	\$0	\$1,600
2048	\$0	\$0	\$0	\$1,500	\$0	\$1,500
2049	\$0	\$0	\$0	\$1,300	\$0	\$1,300
2050	\$0	\$0	\$0	\$1,300	\$0	\$1,300
2051	\$0	\$0	\$0	\$1,300	\$0	\$1,300
2052	\$0	\$0	\$0	\$1,300	\$0	\$1,300
2053	\$0	\$0	\$0	\$1,300	\$0	\$1,300
2054	\$0	\$0	\$0	\$1,300	\$0	\$1,300
2055	\$0	\$0	\$0	\$1,300	\$0	\$1,300

<sup>a</sup> Values rounded to two significant digits; negative values denote lower costs, i.e., savings in expenditures.

4. Total Social Costs

Adding together the cost elements outlined in sections IV.E.1, IV.E.2, and IV.E.3, we estimated the total social costs associated with the final CO<sub>2</sub> standards which reflect our modeled potential compliance pathway; these total social costs associated with the final standards relative to the reference

case are shown in Table IV-34. Table IV-34 presents costs in 2022\$ in undiscounted annual values along with net present values at 2-percent, 3-percent and 7-percent discount rates with values discounted to the 2027 calendar year. In addition, the battery tax credit, vehicle tax credit, EVSE tax credit, sales taxes, Federal excise tax and state registration fees for ZEVs are

not included in the social costs analysis discussed in this subsection because taxes, registration fees, and tax credits are transfers and not social costs.

As shown in Table IV-34, starting in 2035, our analysis demonstrates that total program costs under the final standards scenario are lower than the total program costs under the reference case.

**Table IV-34 Total Technology Package, Operating Cost, and EVSE Cost Impacts of the Final Standards Relative to the Reference Case, All Regulatory Classes and All Fuels, Millions of 2022\$<sup>a</sup>**

Calendar Year	Total Technology Package Costs	Total Operating Costs	Total EVSE RPE Costs	Sum
2027	\$30	-\$100	\$440	\$370
2028	-\$14	-\$220	\$610	\$380
2029	-\$85	-\$390	\$730	\$260
2030	\$160	-\$380	\$630	\$410
2031	\$270	-\$540	\$1,300	\$1,100
2032	\$480	-\$810	\$2,000	\$1,700
2033	\$310	-\$1,200	\$1,900	\$1,000
2034	\$260	-\$1,600	\$1,700	\$360
2035	\$160	-\$2,200	\$1,600	-\$450
2036	\$23	-\$2,500	\$1,600	-\$950
2037	-\$25	-\$3,000	\$1,500	-\$1,400
2038	-\$140	-\$3,300	\$1,500	-\$2,000
2039	-\$230	-\$3,700	\$1,500	-\$2,400
2040	-\$260	-\$4,100	\$1,500	-\$2,900
2041	-\$330	-\$4,300	\$1,500	-\$3,100
2042	-\$400	-\$4,600	\$1,400	-\$3,500
2043	-\$390	-\$5,100	\$1,400	-\$4,000
2044	-\$450	-\$5,400	\$1,400	-\$4,400
2045	-\$510	-\$5,100	\$1,400	-\$4,200
2046	-\$490	-\$4,900	\$1,300	-\$4,100
2047	-\$530	-\$5,400	\$1,300	-\$4,600
2048	-\$560	-\$5,800	\$1,300	-\$5,100
2049	-\$590	-\$6,300	\$1,300	-\$5,600
2050	-\$570	-\$6,600	\$1,200	-\$5,900
2051	-\$590	-\$6,800	\$1,200	-\$6,100
2052	-\$620	-\$7,000	\$1,200	-\$6,400
2053	-\$640	-\$7,100	\$1,200	-\$6,600
2054	-\$610	-\$7,300	\$1,200	-\$6,700
2055	-\$590	-\$7,400	\$1,100	-\$6,900
PV, 2%	-\$4,200	-\$76,000	\$28,000	-\$52,000
PV, 3%	-\$3,200	-\$63,000	\$25,000	-\$42,000
PV, 7%	-\$1,000	-\$32,000	\$15,000	-\$18,000
AV, 2%	-\$190	-\$3,500	\$1,300	-\$2,400
AV, 3%	-\$170	-\$3,300	\$1,300	-\$2,200
AV, 7%	-\$83	-\$2,600	\$1,300	-\$1,400

<sup>a</sup> Values rounded to two significant digits; negative values denote lower costs, i.e., savings in expenditures.

BILLING CODE 6560-50-C

**V. Estimated Emission Impacts From the Final Standards**

We project that the final CO<sub>2</sub> standards will result in downstream emission reductions of GHGs<sup>934</sup> from heavy-duty vehicles. Downstream emission processes are those that come directly from a vehicle, such as tailpipe exhaust, crankcase exhaust, evaporative emissions, and refueling emissions. While the final standards do not directly

<sup>934</sup> Although the final standards do not directly address non-CO<sub>2</sub> GHGs, we anticipate that the final standards will result in reductions of downstream emissions of non-CO<sub>2</sub> GHGs.

address criteria pollutants or air toxics, we project that they will also result in reductions of downstream emissions of both criteria pollutants and air toxics. We project that these anticipated emission reductions will be achieved through increased adoption of HD vehicle and engine technologies to reduce GHG emissions. Examples of these GHG-reducing technologies that manufacturers may choose to adopt include ICE vehicle technologies, heavy-duty battery electric vehicle (BEV) technologies and fuel cell vehicle (FCEV) technologies. We projected the emission reductions from the modeled potential compliance pathway's

technology packages described in section II. As we note there, manufacturers may elect to comply using a different combination of HD vehicle and engine technologies than we modeled. In fact, we developed additional example potential compliance pathways that meet the final Phase 3 MY 2027 through MY 2032 and later CO<sub>2</sub> emission standards (see preamble section II.F.3). These pathways would achieve the same level of vehicle CO<sub>2</sub> emission reductions and downstream CO<sub>2</sub> emission reductions discussed in this section.

With the modeled increase in adoption of GHG reducing technologies,

including heavy-duty BEVs and FCEVs (together referred to as ZEVs), the final standards will also impact upstream emissions of GHGs and other pollutants. Upstream emissions sources are those that do not come from the vehicle itself but are attributable to a vehicle, such as from electricity generation for charging BEVs, the production of hydrogen used to fuel FCEVs, and emissions generated during petroleum-based fuel production and distribution. We estimated the impacts of the final standards on emissions from electricity generation units (EGUs) and on emissions from fuel refineries.

In general, the final rule emissions inventory analysis methodology mirrors the approach we took for the proposal, with some updates to our modeling and assumptions. First, we utilized the most recent version of EPA's Motor Vehicle Emission Simulator (MOVES) model. Second, we updated the reference case<sup>935</sup> in several ways, including accounting for EPA granting California the preemption waiver for its ACT rule under CAA section 209(b).<sup>936</sup> Third, we performed new Integrated Planning Model (IPM) runs to evaluate power sector emission impacts. Fourth, we changed our assumptions about refinery throughput to better account for U.S. exports of gasoline and diesel. These changes are explained in more detail in section V.A and RIA Chapter 4.

To estimate the downstream emission reductions from the final standards, we used MOVES4.R3, which was created based on the latest major public version of MOVES, MOVES4.0.0, and contains various updates including updates to the adoption rate and energy consumption of heavy-duty electric vehicles. These model updates are summarized in Chapter 4.2 of the RIA, and MOVES4.0.0 data and algorithms are described in detail in the technical

<sup>935</sup> The reference case is a baseline scenario that represents the U.S. without the final rule.

<sup>936</sup> 88 FR 20688, April 6, 2023.

reports that are available online and in the docket for this rulemaking.<sup>937 938</sup>

To estimate upstream EGU emission impacts from the final standards, we used the 2022 post-IRA version of the Integrated Planning Model (IPM), which is a linear programming model that forecasts EGU operation and emissions by calculating the most cost-effective way for the electricity generation and transmission system to meet its total demand. IPM accounts for many variables that impact the operation and emissions of EGUs, including total energy demand (including reserve requirements and peak load demand), planned EGU retirements, final rules that impact EGU operation, fuel prices, and infrastructure buildout costs, and congressional action like the Inflation Reduction Act. More details on IPM and the inputs and post-processing used to evaluate the impact of the final standards on EGU emissions can be found in the Chapter 4.2.4 of the RIA.

To estimate upstream refinery impacts from the final standards, we adjusted an existing refinery inventory from the emissions modeling platform<sup>939</sup> to reflect updated onroad fuel demand from heavy-duty vehicles. The refinery inventory adjustments were developed using MOVES projections of liquid fuel demand for both the reference case and the final standards. More details on the refinery impacts methodology can be found in Chapter 4.2.5 of the RIA.

We received several comments on the scope of upstream emissions to be

<sup>937</sup> See <https://www.epa.gov/moves/moves-onroad-technical-reports#moves4>.

<sup>938</sup> Murray, Evan. Memorandum to Docket EPA-HQ-OAR-2022-0985. "MOVES4.0.0 Technical Reports". February 2024.

<sup>939</sup> The emissions modeling platform is a product of the National Emissions Inventory Collaborative consistent of more than 245 employees of state and regional air agencies, EPA, and Federal Land Management agencies. It includes a full suite of base year (2016) and projection year (2023 and 2028) emission inventories modeled using EPA's full suite of emissions modeling tools, including MOVES, SMOKE, and CMAQ. <https://www.epa.gov/air-emissions-modeling/2016v3-platform>.

considered and estimated by EPA. The modeling for the final rule includes the three most significant sectors in terms of understanding the impact of the standards on overall emissions (downstream, EGUs and refineries). We did not estimate impacts on emissions from other sectors with comparatively smaller potential impacts, like those related to the extraction or transportation of fuels for either EGUs or refineries.<sup>940</sup> Detailed discussion of the comments we received on upstream modeling and our responses can be found in Chapter 13 of the RTC.

#### A. Model Inputs

##### 1. MOVES Inputs

We used MOVES to evaluate the downstream emissions impact of the final standards relative to a reference case. MOVES defines vehicles using a combination of source type and regulatory class, where source type roughly defines a vehicle's vocation or usage pattern, and regulatory class roughly defines a vehicle's gross vehicle weight rating (GVWR) or weight class. Table V-1 defines MOVES heavy-duty source types and Table V-2 defines MOVES heavy-duty regulatory classes.<sup>941 942 943</sup>

<sup>940</sup> We included upstream emissions from FCEVs in our EGU emissions modeling, as is discussed in Chapter 4 of the RIA and later in section V.A.2.

<sup>941</sup> MOVES vehicle definitions encompass the regulatory subcategories of the final standards but are not identical to them. The technology evaluation in HD TRUCS uses 101 vehicle types which can be mapped to MOVES source types and regulatory classes, but no single vehicle type in HD TRUCS corresponds to any single source type or regulatory class. In relation to the final standards, we synonymize combination short-haul tractors (MOVES source type 61) with day cabs and combination long-haul tractors (MOVES source type 62) with sleeper cabs.

<sup>942</sup> 40 CFR 86.091-2. Available online: <https://www.govinfo.gov/content/pkg/CFR-1998-title40-vol12/pdf/CFR-1998-title40-vol12-sec86-091-2.pdf>.

<sup>943</sup> U.S. EPA. "Frequently Asked Questions about Heavy-Duty 'Glider Vehicles' and 'Glider Kits'". July 2015. Available online: <https://nepis.epa.gov/Exec/ZyPDF.cgi?Dockey=P100MUVI.PDF>.

**Table V-1 MOVES Heavy-Duty Source Type Definitions**

sourceTypeID	Source Type Description
31	Passenger Truck
32	Light Commercial Truck
41	Other Bus
42	Transit Bus
43	School Bus
51	Refuse Truck
52	Single Unit Short-haul Truck
53	Single Unit Long-haul Truck
54	Motor Home
61	Combination Short-haul Truck
62	Combination Long-haul Truck

**Table V-2 MOVES Heavy-Duty Regulatory Class Definitions**

regClassID	Regulatory Class Name	Regulatory Class Description and GVWR Range
42	LHD45	Class 4 and 5 Trucks and engine-certified Class 3 Trucks 14,000 lbs < GVWR ≤ 19,500 lbs
46	MHD67	Class 6 and 7 Trucks 19,500 lbs < GVWR ≤ 33,000 lbs
47	HHD8	Class 8a and 8b Trucks GVWR > 33,000 lbs
48	Urban Bus	Urban Bus (see 40 CFR 86.091-2)
49	Gliders	Glider Vehicles (see EPA-420-F-15-904)

In modeling heavy-duty ZEV populations in the reference case, a scenario that represents the United States without the final standards, we considered several different factors related to purchaser acceptance of new technologies as discussed in RIA Chapter 2, along with three factors described in this section and in greater detail in RIA Chapter 1.

First, the market has evolved such that early HD ZEV models are in use today for some applications and HD ZEVs are expected to expand to many more applications, as discussed in RIA Chapters 1.1, 1.5, and 1.7. Additionally, manufacturers have already made substantial investments in ZEV technologies and have announced plans to rapidly increase those investments

over the next decade. Second, the IRA and the BIL provide many monetary incentives for the production and purchase of ZEVs in the heavy-duty market, as well as incentives for electric vehicle charging infrastructure. Third, there have been actions by states to accelerate the adoption of heavy-duty ZEVs. Notably, absent the final standards, the State of California’s Advanced Clean Trucks (ACT) program imposes minimum ZEV sales requirements beginning in model year 2024 in California and states that have adopted the program under CAA section 177. EPA granted the waiver of preemption for California’s ACT rule waiver under CAA section 209(b) on March 30, 2023.<sup>944</sup>

Our reference case for this final rulemaking shows increased ZEV adoption for all heavy-duty vehicle types compared to our reference case for the NPRM. First, the reference case includes the ACT program, as suggested by many commenters and as EPA indicated would be likely at proposal.<sup>945</sup> The reference case for this final rule thus reflects manufacturers’ compliance with the ACT program in California and in the seven other states that have finalized adoption of ACT.<sup>946</sup> As explained further in this section, it also includes a lower, non-zero level of ZEV adoption in the other 42 states. The national reference case HD ZEV adoption rates, based on a sales-weighting of state-specific adoption rates, are presented in Table V-3.

<sup>944</sup> 88 FR 20688, April 6, 2023.

<sup>945</sup> EPA granted California’s waiver request on March 30, 2023, which left EPA insufficient time to develop an updated reference case for inclusion in the proposal. See 88 FR 25989.

<sup>946</sup> At the time we performed the inventory modeling analysis, seven states had adopted ACT in addition to California. Oregon, Washington, New York, New Jersey, and Massachusetts adopted ACT beginning in MY 2025 while Vermont adopted ACT beginning in MY 2026 and Colorado in MY 2027. Three other states, New Mexico, Maryland, and Rhode Island adopted ACT (beginning in MY 2027) in November and December of 2023, but there was not sufficient time for us to incorporate them as ACT states in our modeling.

Further discussion of the reference case ZEV adoption we modeled in MOVES can be found in RIA Chapter 4.2.21 and breakdowns of ZEV adoption rates by model year, source type, regulatory class, and location can be found in RIA Appendix B.

**Table V-3 National Heavy-Duty ZEV Adoption in the Reference Case**

Model Year <sup>a</sup>	LHD Vocational	MHD Vocational	HHD Vocational	Short-Haul Tractors	Long-Haul Tractors
2024	3.2%	2.2%	1.1%	1.0%	0.0%
2025	5.4%	3.7%	2.4%	2.2%	0.0%
2026	6.4%	4.4%	2.8%	3.2%	0.0%
2027	10.1%	6.9%	4.6%	4.7%	0.4%
2028	15.2%	10.4%	6.9%	6.1%	0.7%
2029	20.2%	13.8%	9.2%	7.4%	1.3%
2030	25.2%	17.2%	11.4%	8.7%	1.9%
2031	27.6%	18.9%	12.5%	9.3%	3.7%
2032	30.1%	20.5%	13.6%	10.4%	4.7%
2033	33.1%	22.6%	14.9%	10.5%	4.8%
2034	36.2%	24.9%	16.2%	10.8%	4.9%
2035	39.5%	27.2%	17.5%	11.0%	5.0%
...	...	...	...	...	...
2055	52.0%	37.3%	20.3%	15.1%	7.2%

<sup>a</sup> The ZEV adoption rates for model years 2036 through 2054 increase linearly between the adoption rates in model years 2035 and 2055. RIA Appendix B presents the adoption rates for each model year from 2024 through 2055.

Several commenters noted that our reference case should quantitatively reflect not only the anticipated ZEV sales from the ACT rule in California and other states which have adopted it, but also ZEV adoption resulting from numerous other factors. The commenters specifically suggested to include (1) state policies such as California’s Advanced Clean Fleets<sup>947</sup> and Innovative Clean Transit rules and the NESCAUM MHD ZEV MOU;<sup>948</sup> (2) manufacturer, fleet, and government commitments for producing and procuring ZEVs; (3) adoption for vehicles that reach cost parity with conventional vehicles; and (4) the billions of dollars of programs to support HD ZEV deployment in the BIL and the IRA. Our revised reference case for this final rulemaking includes greater HD ZEV adoption than the reference case in the NPRM for the reasons cited in the preceding paragraphs.

We reviewed the literature to evaluate future HD ZEV projections in the

absence of a Phase 3 regulation. We found that the literature had varied projections. For instance, the National Renewable Energy Laboratory (NREL) conducted an analysis in early 2022, prior to the IRA, that projected 22 percent HD ZEV sales by 2030 and 98 percent sales by 2040, along with 100 percent of bus sales being ZEVs by 2030.<sup>949</sup> This analysis assumed economics alone drive adoption (*i.e.*, total cost of ownership), and therefore they did not consider non-financial factors such ZEV product research and development timelines, ZEV manufacturing timelines, the availability of ZEV models, manufacturing or infrastructure constraints, driver preferences, and other factors. ACT Research also conducted an analysis prior to IRA and projected HD ZEV sales of 24 percent in 2024, 26 percent in 2030, and 34 percent in 2031.<sup>950</sup> The International Council for Clean Transportation (ICCT) published a pair of analyses in early 2023 and projected a variety of

scenarios.<sup>951 952</sup> Specifically, they projected that in 2030, HD ZEV sales would reach 10 to 51 percent for Class 4–8 trucks, 2 to 34 percent for buses, 16 to 44 percent for short-haul tractors, and 0 to 16 percent for long-haul tractors, with adoption rates generally increasing in future years. The range in their values results from two scenarios. The lower adoption rates represent inclusion of only the regulatory baseline, including the ACT rule and Innovative Clean Transit rule. The higher adoption rates represent their aforementioned regulatory baseline as well as additional market growth driven primarily by the market’s response to incentives in the IRA. EDF and ERM conducted a follow-up analysis of their HD ZEV sales projections after the IRA passed in 2022.<sup>953</sup> They project several scenarios

<sup>947</sup> EPA received a waiver request under CAA section 209(b) and 209(e) from California for the ACF rule on November 15, 2023 (see <https://www.epa.gov/state-and-local-transportation/vehicle-emissions-california-waivers-and-authorizations#current>). EPA is currently reviewing the waiver request for the CA ACF rule. Because EPA action on California’s waiver request is pending, we did not include the full effects of ACF in the reference case.

<sup>948</sup> NESCAUM MOU, available at <https://www.nescaum.org/documents/mhdv-zev-mou-20220329.pdf>.

<sup>949</sup> Ledna, Catherine, et al. “Decarbonizing Medium- & Heavy-Duty On-Road Vehicles: Zero-Emission Vehicles Cost Analysis.” March 2022. Slide 25. Available online: <https://www.nrel.gov/docs/fy22osti/82081.pdf>.

<sup>950</sup> Lockridge, Deborah. “ACT: Third of Class 4–8 Vehicles to be Battery-Electric in 10 Years.” June 2021. Available online: <https://www.truckinginfo.com/10144947/act-third-of-class-4-8-vehicles-to-be-battery-electric-in-10-years>.

<sup>951</sup> Ragon, Pierre-Louis, Buysse, Claire, Sen, Arijit, Meyer, Michelle, Benoit, Jonathan, Miller, Josh, Rodriguez, Felipe. “Potential Benefits of the U.S. Phase 3 Greenhouse Gas Emissions Regulation for Heavy-Duty Vehicles.” International Council on Clean Transportation. April 2023. Available online: <https://theicct.org/wp-content/uploads/2023/04/hdv-phase3-ghg-standards-benefits-apr23.pdf>.

<sup>952</sup> Slowik, Peter et al. “Analyzing the Impact of the Inflation Reduction Act on Electric Vehicle Uptake in the United States.” International Council on Clean Transportation and Energy Innovation Policy & Technology LLC. January 2023. Available online: <https://theicct.org/wp-content/uploads/2023/01/ira-impact-evs-us-jan23.pdf>.

<sup>953</sup> Robo, Ellen and Dave Seamonds. Technical Memo to Environmental Defense Fund: Investment Reduction Act Supplemental Assessment: Analysis of Alternative Medium- and Heavy-Duty Zero-Emission Vehicle Business-As-Usual Scenarios.

which range between 11 and 42 percent HD ZEV sales in 2029 when including long-haul tractors. The EDF/ERM analysis found that IRA will help accelerate ZEV adoption due to the purchasing incentives, which drives HD ZEVs to reach upfront vehicle cost parity at least five years sooner than without the IRA incentives. The ACT Research, ICCT, and EDF/ERM projections, similar to the 2022 NREL study, also did not consider several important real-world factors noted, which would in general be expected to slow down or reduce ZEV sales.

We note that our reference case projection of ZEV adoption in this final rulemaking includes less aggressive ZEV adoption than urged by a number of commenters or when compared to the studies from NREL, ACT Research, ICCT, and EDF/ERM because we consider real-world factors submitted to the record by other commenters, such as the considerations we described that NREL did not consider in their projections. Therefore, while we think our reference case projection appropriately weighs the relevant real-world factors compared to the more limited set of factors considered in these studies and comments, we may be

projecting emission reductions due to the final standards that are greater than could be expected using a reference case that reflects higher levels of ZEV adoption in the HD market absent our rule. At the same time, our use of this reference case would also overestimate the costs of compliance of this final rule if the market would achieve higher levels of ZEV adoption than we project in the absence of our final standards.<sup>954</sup>

In modeling the control case (*i.e.*, the effect of the final standards), we analyze the impact of the final CO<sub>2</sub> emission standards on a heavy-duty fleet that is projected in our potential compliance pathway to include both ICE vehicles and an increase in ZEV adoption consistent with our technology packages described in preamble section II. Our modeling of the ICE vehicle portions of the technology packages reflect CO<sub>2</sub> emission improvements projected in previously promulgated standards, notably HD GHG Phase 2; thus, we do not model an increase in ICE vehicle efficiency resulting from the final standards. Future HD ZEV populations in MOVES for the final standards scenario were estimated at the national level using HD TRUCS based on the technology assessment for BEVs and

FCEVs discussed in section II of this preamble and in RIA Chapter 2. We calculated ZEV adoption by assuming that a) in no combination of MY, source type, regulatory class, and location (*i.e.*, states that have or have not adopted ACT) would ZEV adoption in the control case be lower than in the reference case, and b) HD ZEV sales would first meet the requirements of the ACT rule in California and the states which have adopted the ACT rule under CAA section 177, and then sales would increase further in all other states consistent with our projections of national ZEV adoption in our principal modelled compliance pathway (described in section II and RIA Chapter 2).

Table V-4 shows the ZEV adoption rates used in modeling the final standards in MOVES from 2027 through 2032. We calculated ZEV adoption rates for the alternative using a similar methodology and those rates are discussed in section IX. Further discussion of the ZEV adoption rates we modeled can be found in RIA Chapter 4.2.3 and breakdowns of ZEV adoption rates by technology, model year, source type, regulatory class, and location can be found in RIA Appendix B.

**Table V-4 National Heavy-Duty ZEV Adoption in the Control Case**

Model Year	LHD Vocational	MHD Vocational	HHD Vocational <sup>a</sup>	Short-Haul Tractors	Long-Haul Tractors <sup>b</sup>
2027	18.4%	13.5%	4.6%	5.3%	0.4%
2028	23.6%	16.7%	9.4%	8.4%	0.7%
2029	28.8%	20.0%	11.9%	11.9%	1.3%
2030	34.0%	23.2%	14.5%	16.3%	6.2%
2031	47.5%	32.0%	20.1%	27.7%	12.5%
2032	61.2%	40.7%	25.7%	39.9%	25.0%

<sup>a</sup> As explained in section II, for HHD vocational vehicles, we are not finalizing revisions to the Phase 2 standards for MY 2027. ZEV adoption for these vehicles in this model year was set to be equal to the reference case.

<sup>b</sup> For sleeper cab tractors, which are represented by long-haul tractors (source type 62) in MOVES, we did not propose and are not finalizing revisions to MY 2027 standards or new standards for MYs 2028 or 2029. ZEV adoption for this source type in these model years was set to be equal to the reference case.

2. Upstream Modeling

We used the 2022 post-IRA version of IPM to estimate the EGU emissions associated with the additional energy demand from increased HD ZEV adoption. Relative to the NPRM, we performed new IPM runs for updated

reference and control cases that all account for the IRA. Because of the lead times necessary to complete our IPM modeling for the final rulemaking analysis, we developed IPM inputs for draft interim reference and control scenarios which do not directly

correspond to the ZEV adoption rates and energy demand for the reference and control cases described in section V.A.1.

The differences between the draft interim and final scenarios are small compared to the difference between IPM

ERM. August 19, 2022. Page 9. Available online: <https://www.erm.com/contentassets/154d08e0d0674752925cd82c66b3e2b1/edf-zev-baseline-technical-memo-addendum.pdf>.

<sup>954</sup> We also received comment questioning how many ZEVs will be sold nationwide as a result of

ACT (see RTC section 2.4). Given the comments on variability in HD ZEV adoption projections absent the final standards, and the corresponding potential uncertainty in the reference case, we also performed a sensitivity analysis using a reference case that has lower HD ZEV adoption compared to the final rule reference case presented here, as we expected such

a scenario may result in a greater magnitude of costs. We present this sensitivity analysis in RIA Chapter 4.10, where we demonstrate that program costs are reasonable when compared to a reference case that has lower HD ZEV adoption than presented here.

defaults and the final scenarios. Therefore, we evaluated that we could use the draft interim IPM results to calculate adjusted inventories that provide a good approximation of the EGU emissions impact of the final standards. The details of this methodology can be found in Chapter 4.2.4 of the RIA.

To account for upstream emissions from the production of hydrogen used to fuel FCEVs, we made a simplifying assumption in modeling the final standards that all hydrogen used for FCEVs would be produced via electrolysis of water using electricity from the grid and can therefore be entirely represented as additional demand to EGUs and modeled using IPM. We developed a scaling factor to account for the mass of hydrogen that would need to be produced to meet the FCEV energy demand calculated by MOVES.

We received comments noting that hydrogen in the U.S. today is primarily produced via steam methane reforming (SMR), largely as part of petroleum refining and ammonia production. Given the BIL and IRA provisions that meaningfully incentivize reducing the emissions and carbon intensity of hydrogen production, as well as new transportation and other demand drivers and potential future regulation, we anticipate more hydrogen will be produced by electrolysis in the future. However, to evaluate the upstream impacts of FCEVs more fully under different scenarios, for the final rule analysis, we also performed a comparative analysis of upstream emissions under different hydrogen production pathways. The comparative analysis offers a qualitative range for the upstream emissions that are projected from increased FCEV adoption in the potential compliance pathway's technology package demonstrating the feasibility of the final standards. More details on our upstream analysis of emissions from FCEVs, including the derivation of the scaling factors for hydrogen produced by electrolysis and the emission factors for hydrogen

produced via SMR, are documented in Chapter 4.2.4 of the RIA.

The emission impacts presented in this section are based on the electrolysis scenario, but emission comparisons between the electrolysis and SMR scenarios can be found in Chapter 4.8 of the RIA. The comparative analysis shows that the relative emissions of producing hydrogen via SMR versus electrolysis change over time. Compared to grid-based electrolysis, we estimate SMR to have lower emissions in earlier years and higher emissions in later years.

To estimate refinery emission impacts from the final standards, we adjusted an existing refinery inventory from the emissions modeling platform to reflect updated onroad fuel demand from heavy-duty vehicles. The refinery inventory adjustments were developed using MOVES projections of liquid fuel demand for both the reference case and the final standards. Our refinery emission methodology is discussed in detail in Chapter 4.2.5 of the RIA.

In the NPRM analysis we assumed that 93 percent of the drop in domestic demand would be reflected in reduced refinery activity. We received several comments noting that, in response to lower domestic demand, U.S. refineries would increase exports and continue refining similar volumes of liquid fuels. After consideration of these comments, for the final rule, we projected that 50 percent of the drop in domestic demand would be reflected in reduced refinery activity. There remains large uncertainty about how the U.S. refining sector will respond to greater electrification in the onroad sector, and Chapter 4.9 of the RIA includes a sensitivity analysis that assumes that 20 percent of the drop in domestic demand would be reflected in reduced refinery activity.

*B. Estimated Emission Impacts From the Final Standards*

This final rule includes CO<sub>2</sub> emission standards for MYs 2027 through 2032 and beyond. Our modeled potential compliance pathway to demonstrate the feasibility of these final standards

includes both ICE vehicles and an increase in ZEV adoption consistent with our technology packages described in preamble section II. Because ZEVs do not produce any tailpipe emissions, we expect reductions in downstream GHG emissions as well as reductions in downstream emissions of criteria pollutants and air toxics. In our analysis, operation of HD ZEVs increases emissions from EGUs but leads to reduced emissions from refineries.

We present downstream emission reductions in section V.B.1 and upstream emission impacts in section V.B.2. Section V.B.3 presents the net emission impacts of the final standards. The impact of the final standards on cumulative GHG emissions are presented in section V.B.4. The downstream and upstream impacts of the alternative are discussed in section IX.

Because all our modeling is done for a full national domain, emissions impacts cover the full national inventory. Emissions impacts in other domains, such as particular regions or localities in the United States, are likely to differ from the impacts presented here.

1. Estimated Impacts on Downstream Emissions

Our estimates of the downstream emission reductions of GHGs that will result from the final standards relative to the reference case are presented in Table V-5 for calendar years 2035, 2045, and 2055. Total GHG emissions, or CO<sub>2</sub> equivalent (CO<sub>2</sub>e), are calculated by summing all GHG emissions multiplied by their 100-year global warming potentials (GWP). The GWP values used in Table V-5 are consistent with the 2014 IPCC Fifth Assessment Report (AR5).<sup>955</sup>

<sup>955</sup> IPCC, 2014: Climate Change 2014: Synthesis Report. Contribution of Working Groups I, II and III to the Fifth Assessment Report of the Intergovernmental Panel on Climate Change [Core Writing Team, R.K. Pachauri and L.A. Meyer (eds.)]. Available online: [https://www.ipcc.ch/site/assets/uploads/2018/02/SYR\\_AR5\\_FINAL\\_full.pdf](https://www.ipcc.ch/site/assets/uploads/2018/02/SYR_AR5_FINAL_full.pdf).



**Table V-5 Annual Downstream Heavy-Duty GHG Emission Reductions from the Final Standards in Calendar Years 2035, 2045, and 2055**

Pollutant	100-year GWP	CY 2035 Reductions		CY 2045 Reductions		CY 2055 Reductions	
		Million Metric Tons	Percent	Million Metric Tons	Percent	Million Metric Tons	Percent
Carbon Dioxide (CO <sub>2</sub> )	1	32.5	9%	66.3	19%	70.0	20%
Methane (CH <sub>4</sub> )	28	0.002	3%	0.006	10%	0.009	12%
Nitrous Oxide (N <sub>2</sub> O)	265	0.005	9%	0.01	19%	0.01	20%
CO <sub>2</sub> Equivalent (CO <sub>2</sub> e)	---	33.8	9%	69.1	19%	73.0	20%

In 2055, we estimate that the final standards will reduce downstream emissions of CO<sub>2</sub> from heavy-duty vehicles by 20 percent, methane by 12 percent, and nitrous oxide by 20 percent, resulting in a reduction of 20 percent for total CO<sub>2</sub> equivalent emissions from heavy-duty vehicles. Table V-5 also shows that most of the GHG emission reductions are from CO<sub>2</sub>, which represents approximately 96 percent of all heavy-duty GHG emission reductions from the final standards.

We note that these reductions are lower in the final rule than the proposal. We modeled the proposed standards with our updated FRM methodologies and reference case. The results are presented in RIA Chapter 4.11 and demonstrate that the emission impact differences are primarily due to the increased number of ZEVs considered in the reference case (as discussed earlier in this preamble section V.A) and do not indicate that the final standards are

meaningfully less stringent than the proposed standards.

We expect the final CO<sub>2</sub> emission standards will also result in reductions of non-GHG pollutants. Table V-6 presents our estimates of the downstream emission reductions of criteria pollutants and air toxics from heavy-duty vehicles that will result from the final standards in calendar years 2035, 2045, and 2055 relative to the reference case.

**Table V-6 Annual Downstream Heavy-Duty Emission Reductions from the Final Standards in Calendar Years 2035, 2045, and 2055 for Criteria Pollutants and Air Toxics**

Pollutant	CY 2035 Reductions		CY 2045 Reductions		CY 2055 Reductions	
	U.S. Tons	Percent	U.S. Tons	Percent	U.S. Tons	Percent
Oxides of Nitrogen (NO <sub>x</sub> )	10,801	3%	47,027	16%	54,268	20%
Particulate Matter (PM <sub>2.5</sub> ) <sup>a</sup>	126	2%	302	5%	331	5%
Volatile Organic Compounds (VOC)	3,014	6%	6,426	17%	7,242	20%
Sulfur Dioxide (SO <sub>2</sub> )	126	9%	256	19%	270	20%
Carbon Monoxide (CO)	49,273	6%	117,155	17%	131,014	19%
1,3-Butadiene	7	11%	14	27%	14	27%
Acetaldehyde	62	6%	138	17%	160	17%
Benzene	38	8%	80	22%	82	25%
Formaldehyde	41	4%	100	14%	126	15%
Naphthalene <sup>b</sup>	3	5%	6	22%	6	23%

<sup>a</sup> PM<sub>2.5</sub> estimates include both exhaust and non-exhaust emissions. RIA Chapters 4.1 and 4.3 contain a more detailed discussion of these impacts.

<sup>b</sup> Naphthalene includes both gas and particle phase emissions.

In 2055, we estimate the final standards will reduce heavy-duty vehicle emissions of NO<sub>x</sub> by 20 percent,<sup>956</sup> PM<sub>2.5</sub> by 5 percent, VOC by 20 percent, and SO<sub>2</sub> by 20 percent. Reductions in air toxics in 2055 range from 15 percent for formaldehyde to 27 percent for 1,3-butadiene. Again, it is worth noting that these reductions are similarly lower in the final rule than the proposal primarily due to the increased number of ZEVs considered in the reference case. Our increased reference case ZEV adoption is greatest for light and medium heavy-duty vehicles,

which means LHD and MHD gasoline vehicles make up a much smaller portion of the HD fleet in the final reference case than in our NPRM reference case. Therefore, emissions reductions for pollutants which are driven by emissions from gasoline vehicles, most notably PM<sub>2.5</sub> and VOCs, are much smaller in our final analysis than our NPRM analysis. This is discussed in more detail in RIA Chapter 4.

Chapter 4.3 of the RIA contains more details on downstream emission reductions by vehicle type, fuel type, and emission process, as well as year-

over-year impacts from 2027 through 2055.

**2. Estimated Impacts on Upstream Emissions**

The final standards are projected to increase emissions from EGUs. Our estimates of the additional GHG emissions from EGUs due to the final standards, relative to the reference case, are presented in Table V-7 for calendar years 2035, 2045, and 2055, in million metric tons (MMT). Our estimates for additional criteria pollutant emissions are presented in Table V-8.

<sup>956</sup> The version of MOVES used to model the final standards includes the HD2027 Low NO<sub>x</sub> standards

(88 FR 4296, March 27, 2023), so it is accounted for in the reference case. NO<sub>x</sub> reductions presented

here are incremental to the impacts from that final rule.

**Table V-7 Annual GHG Emission Increases from EGUs from the Final Standards in Calendar Years 2035, 2045, and 2055**

Pollutant	100-year GWP	Additional EGU Emissions (MMT)		
		CY 2035	CY 2045	CY 2055
Carbon Dioxide (CO <sub>2</sub> )	1	29.3	14.5	12.9
Methane (CH <sub>4</sub> )	28	0.00186	0.00033	0.00026
Nitrous Oxide (N <sub>2</sub> O)	265	0.00026	0.00004	0.00003
CO <sub>2</sub> Equivalent (CO <sub>2</sub> e)	---	29.4	14.5	12.9

**Table V-8 Annual Criteria Pollutant Emission Increases from EGUs from the Final Standards in Calendar Years (CYs) 2035, 2045, and 2055**

Pollutant	Additional EGU Emissions (U.S. Tons)		
	CY 2035	CY 2045	CY 2055
Oxides of Nitrogen (NO <sub>x</sub> )	9,719	1,588	1,520
Particulate Matter (PM <sub>2.5</sub> )	1,418	596	513
Volatile Organic Compounds (VOC)	467	347	196
Sulfur Dioxide (SO <sub>2</sub> )	11,726	648	69

In 2055, we estimate the final standards will increase EGU emissions of CO<sub>2</sub> by 12.9 million metric tons, compared to 29.3 million metric tons in 2035. There are similar trends for all other pollutants. EGU impacts decrease over time because of changes in the projected power generation mix as

electricity generation uses less fossil fuels. Chapter 4.4 of the RIA contains more details and discussion of the impacts of the final CO<sub>2</sub> emission standards on EGU emissions, including year-over-year impacts from 2027 through 2055.

We expect the final standards to lead to a decrease in refinery emissions.

Table V-9 presents the estimated impact of the final standards on GHG emissions from refineries (in metric tons) and Table V-10 presents the estimated impact on criteria pollutant emissions (in U.S. tons) from refineries, both relative to the reference case.

**Table V-9 Annual GHG Emission Reductions from Refineries Due to the Final Standards in Calendar Years 2035, 2045, and 2055**

Pollutant	100-year GWP	Refinery Emission Reductions (Metric Tons)		
		CY 2035	CY 2045	CY 2055
Carbon Dioxide (CO <sub>2</sub> )	1	331,008	649,943	690,477
Methane (CH <sub>4</sub> )	28	17	32	34
Nitrous Oxide (N <sub>2</sub> O)	265	3	6	6
CO <sub>2</sub> Equivalent (CO <sub>2</sub> e)	---	332,240	652,343	693,016

**Table V-10 Annual Criteria Pollutant Emission Reductions from Refineries Due to the Final Standards in Calendar Years (CYs) 2035, 2045, and 2055**

Pollutant	Refinery Emission Reductions (U.S. Tons)		
	CY 2035	CY 2045	CY 2055
Oxides of Nitrogen (NO <sub>x</sub> )	148	288	304
Particulate Matter (PM <sub>2.5</sub> )	34	66	70
Volatile Organic Compounds (VOC)	112	216	226
Sulfur Dioxide (SO <sub>2</sub> )	46	89	94

Like downstream emissions, we expect refinery emission reductions to increase over time as HD ZEV adoption increases, thus reducing demand for refined fossil fuels and the crude oil from which they are produced. For example, we expect refinery emissions of carbon dioxide to decrease by 331 thousand metric tons in 2035 and 690 thousand metric tons in 2055.

3. Estimated Impacts on Combined Downstream and Upstream Emissions

While we present a net emissions impact of the final CO<sub>2</sub> emission standards, it is important to note that some upstream emission sources are not included in the estimates. This is discussed in detail in Chapter 4 of the RIA.

Table V-11 shows a summary of our modeled downstream, upstream, and net GHG emission impacts of the final

standards relative to the reference case (*i.e.*, the emissions inventory in the absence of the final standards), in million metric tons, for calendar years 2035, 2045, and 2055. Table V-12 contains a summary of the modeled net impacts of the final standards on criteria pollutant emissions. As discussed in section II.G, EPA's assessment is that these net impacts are supportive of the final standards.

BILLING CODE 6560-50-P

**Table V-11 Annual Net Impacts<sup>a</sup> on GHG Emissions from the Final Standards in Calendar Years (CYs) 2035, 2045, and 2055**

Pollutant	GWP	Calendar Year	Emission Impact (MMT)			
			Downstream	EGU	Refinery	Net
Carbon Dioxide (CO <sub>2</sub> )	1	2035	-32.5	29.3	-0.3	-3.5
		2045	-66.3	14.5	-0.6	-52.4
		2055	-70.0	12.9	-0.7	-57.8
Methane (CH <sub>4</sub> )	28	2035	-0.002	0.002	0.000	0.000
		2045	-0.006	0.000	0.000	-0.006
		2055	-0.010	0.000	0.000	-0.009
Nitrous Oxide (N <sub>2</sub> O)	265	2035	-0.005	0.000	0.000	-0.005
		2045	-0.010	0.000	0.000	-0.010
		2055	-0.010	0.000	0.000	-0.010
CO <sub>2</sub> Equivalent (CO <sub>2</sub> e)	---	2035	-33.8	29.4	-0.3	-4.7
		2045	-69.1	14.5	-0.7	-55.2
		2055	-73.0	12.9	-0.7	-60.8

<sup>a</sup> We present emissions reductions as negative numbers and emission increases as positive numbers.

**Table V-12 Annual Net Impacts<sup>a</sup> on Criteria Pollutant Emissions from the Final Standards in Calendar Years (CYs) 2035, 2045, and 2055**

Pollutant	Calendar Year	Emission Impact (U.S. Tons)			
		Downstream	EGU	Refinery	Net
Oxides of Nitrogen (NO <sub>x</sub> )	2035	-10,801	9,719	-148	-1,230
	2045	-47,027	1,588	-288	-45,728
	2055	-54,268	1,520	-304	-53,051
Particulate Matter (PM <sub>2.5</sub> )	2035	-126	1,418	-34	1,258
	2045	-302	596	-66	227
	2055	-331	513	-70	113
Volatile Organic Compounds (VOC)	2035	-3,014	467	-112	-2,659
	2045	-6,426	347	-216	-6,295
	2055	-7,242	196	-226	-7,272
Sulfur Dioxide (SO <sub>2</sub> )	2035	-126	11,726	-46	11,554
	2045	-256	648	-89	304
	2055	-270	69	-94	-295

<sup>a</sup> We present emissions reductions as negative numbers and emission increases as positive numbers.

In 2055, we estimate the final standards will result in a net decrease of 61 million metric tons of GHG emissions. We also estimate net decreases in emissions of NO<sub>x</sub>, VOC, and SO<sub>2</sub> in 2055. However, we estimate a net increase in PM<sub>2.5</sub> emissions.

In general, net emission impacts are determined by the interaction of two effects. First, HD ZEV adoption increases over time, thus reducing downstream and refinery emissions. Second, the increase in EGU emissions declines over time as the electricity grid becomes cleaner due to EGU regulations and the future power generation mix

changes, in part driven by the IRA. These effects can balance differently for different pollutants.

Downstream emissions are a more significant source of GHG, NO<sub>x</sub>, and VOC emissions, so net reductions grow over time. However, EGUs are a more significant source of SO<sub>2</sub> emissions (largely driven by coal combustion) and PM<sub>2.5</sub> emissions (largely driven by coal and natural gas combustion). We estimate a net increase in SO<sub>2</sub> emissions in 2035 and 2045 but a net decrease in 2055 as coal is phased out of the electricity sector. Natural gas remains an important fuel for electricity generation,

which is why we estimate a net increase in PM<sub>2.5</sub> in all years. However, consistent with the trends for other pollutants, the magnitude of the PM<sub>2.5</sub> emission increases diminish over time.

#### 4. Cumulative GHG Emission Impacts

The warming impacts of GHGs are cumulative. Table V-13, Table V-14, and Table V-15 present the cumulative GHG impacts that we model will result from the final standards between 2027 through 2055 for downstream emissions, EGU emissions, and refinery emissions, respectively, relative to the reference case.

**Table V-13 Cumulative 2027-2055 Downstream Heavy-Duty GHG Emission Reductions from the Final Standards**

Pollutant	Reduction in MMT	Percent
Carbon Dioxide (CO <sub>2</sub> )	1,347	13%
Methane (CH <sub>4</sub> )	0.127	7%
Nitrous Oxide (N <sub>2</sub> O)	0.199	13%
CO <sub>2</sub> Equivalent (CO <sub>2</sub> e)	1,404	13%

**Table V-14 Cumulative 2027-2055 GHG Emission Increases from EGUs from the Final Standards**

Pollutant	Increase in MMT
Carbon Dioxide (CO <sub>2</sub> )	391.4
Methane (CH <sub>4</sub> )	0.018
Nitrous Oxide (N <sub>2</sub> O)	0.002
CO <sub>2</sub> Equivalent (CO <sub>2</sub> e)	392.5

**Table V-15 Cumulative 2027-2055 GHG Emission Reductions from Refineries from the Final Standards**

Pollutant	Reduction in MMT
Carbon Dioxide (CO <sub>2</sub> )	13.4
Methane (CH <sub>4</sub> )	0.0007
Nitrous Oxide (N <sub>2</sub> O)	0.0001
CO <sub>2</sub> Equivalent (CO <sub>2</sub> e)	13.5

Overall, we estimate the final standards will reduce net GHG

emissions by just over 1 billion metric tons between 2027 and 2055, relative to

the reference case, as is presented in Table V-16.

**Table V-16 Cumulative 2027-2055 Net GHG Emission Impacts<sup>a</sup> (in MMT) Reflecting the Final Standards**

Pollutant	Downstream	EGU	Refineries	Net
Carbon Dioxide (CO <sub>2</sub> )	-1,347	391	-13	-969
Methane (CH <sub>4</sub> )	-0.127	0.018	-0.001	-0.109
Nitrous Oxide (N <sub>2</sub> O)	-0.199	0.002	0.000	-0.197
CO <sub>2</sub> Equivalent (CO <sub>2</sub> e)	-1,404	393	-13	-1,025

<sup>a</sup> We present emissions reductions as negative numbers and emission increases as positive numbers.

**VI. Climate, Health, Air Quality, Environmental Justice, and Economic Impacts**

In this section, we discuss the impacts of the final rule on climate change, health and environmental effects, environmental justice, and oil and electricity and hydrogen consumption. We also discuss our approaches to analyzing the impact of this rule on the heavy-duty vehicle market and employment.

*A. Climate Change Impacts*

Elevated concentrations of greenhouse gases (GHGs) have been warming the planet, leading to changes in the Earth’s climate that are occurring at a pace and in a way that threatens human health, society, and the natural environment. While EPA is not making any new scientific or factual findings with regard to the well-documented impact of GHG emissions on public health and welfare in support of this rule, EPA is providing

in this section a brief scientific background on climate change to offer additional context for this rulemaking and to help the public understand the environmental impacts of GHGs.

Extensive information on climate change is available in the scientific assessments and the EPA documents that are briefly described in this section, as well as in the technical and scientific information supporting them. One of those documents is EPA’s 2009 Endangerment and Cause or Contribute Findings for Greenhouse Gases Under section 202(a) of the CAA (74 FR 66496, December 15, 2009) (“2009 Endangerment Finding”). In the 2009 Endangerment Finding, the Administrator found under section 202(a) of the CAA that elevated atmospheric concentrations of six key well-mixed GHGs—CO<sub>2</sub>, methane (CH<sub>4</sub>), nitrous oxide (N<sub>2</sub>O), HFCs, perfluorocarbons (PFCs), and sulfur hexafluoride (SF<sub>6</sub>)—“may reasonably be

anticipated to endanger the public health and welfare of current and future generations” (74 FR 66523). The 2009 Endangerment Finding, together with the extensive scientific and technical evidence in the supporting record, documented that climate change caused by human emissions of GHGs threatens the public health of the U.S. population. It explained that by raising average temperatures, climate change increases the likelihood of heat waves, which are associated with increased deaths and illnesses (74 FR 66497). While climate change also increases the likelihood of reductions in cold-related mortality, evidence indicates that the increases in heat mortality will be larger than the decreases in cold mortality in the U.S. (74 FR 66525). The 2009 Endangerment Finding further explained that compared with a future without climate change, climate change is expected to increase tropospheric ozone pollution over broad areas of the U.S., including

in the largest metropolitan areas with the worst tropospheric ozone problems, and thereby increase the risk of adverse effects on public health (74 FR 66525). Climate change is also expected to cause more intense hurricanes and more frequent and intense storms of other types and heavy precipitation, with impacts on other areas of public health, such as the potential for increased deaths, injuries, infectious and waterborne diseases, and stress-related disorders (74 FR 66525). Children, the elderly, and the poor are among the most vulnerable to these climate-related health effects (74 FR 66498).

The 2009 Endangerment Finding also documented, together with the extensive scientific and technical evidence in the supporting record, that climate change touches nearly every aspect of public welfare<sup>957</sup> in the U.S., including: Changes in water supply and quality due to changes in drought and extreme rainfall events; increased risk of storm surge and flooding in coastal areas and land loss due to inundation; increases in peak electricity demand and risks to electricity infrastructure; and the potential for significant agricultural disruptions and crop failures (though offset to some extent by carbon fertilization). These impacts are also global and may exacerbate problems outside the U.S. that raise humanitarian, trade, and national security issues for the U.S. (74 FR 66530).

In 2016, the Administrator issued a similar finding for GHG emissions from aircraft under section 231(a)(2)(A) of the CAA.<sup>958</sup> In the 2016 Endangerment Finding, the Administrator found that the body of scientific evidence amassed in the record for the 2009 Endangerment Finding compellingly supported a similar endangerment finding under CAA section 231(a)(2)(A), and also found that the science assessments released between the 2009 and the 2016 Findings “strengthen and further support the judgment that GHGs in the atmosphere may reasonably be anticipated to endanger the public

<sup>957</sup> The CAA states in section 302(h) that “[a]ll language referring to effects on welfare includes, but is not limited to, effects on soils, water, crops, vegetation, manmade materials, animals, wildlife, weather, visibility, and climate, damage to and deterioration of property, and hazards to transportation, as well as effects on economic values and on personal comfort and well-being, whether caused by transformation, conversion, or combination with other air pollutants.” 42 U.S.C. 7602(h).

<sup>958</sup> “Finding that Greenhouse Gas Emissions From Aircraft Cause or Contribute to Air Pollution That May Reasonably Be Anticipated to Endanger Public Health and Welfare.” 81 FR 54422, August 15, 2016. (“2016 Endangerment Finding”).

health and welfare of current and future generations” (81 FR 54424).

Since the 2016 Endangerment Finding, the climate has continued to change, with new observational records being set for several climate indicators such as global average surface temperatures, GHG concentrations, and sea level rise. Additionally, major scientific assessments continue to be released that further advance our understanding of the climate system and the impacts that GHGs have on public

<sup>959</sup> USGCRP, 2017: *Climate Science Special Report: Fourth National Climate Assessment*, Volume I [Wuebbles, D.J., D.W. Fahey, K.A. Hibbard, D.J. Dokken, B.C. Stewart, and T.K. Maycock (eds.)]. U.S. Global Change Research Program, Washington, DC, USA, 470 pp, doi: 10.7930/J0964J6.

<sup>960</sup> USGCRP, 2016: *The Impacts of Climate Change on Human Health in the United States: A Scientific Assessment*. Crimmins, A., J. Balbus, J.L. Gamble, C.B. Beard, J.E. Bell, D. Dodgen, R.J. Eisen, N. Fann, M.D. Hawkins, S.C. Herring, L. Jantarasami, D.M. Mills, S. Saha, M.C.

<sup>961</sup> USGCRP, 2018: *Impacts, Risks, and Adaptation in the United States: Fourth National Climate Assessment, Volume II* [Reidmiller, D.R., C.W. Avery, D.R. Easterling, K.E. Kunkel, K.L.M. Lewis, T.K. Maycock, and B.C. Stewart (eds.)]. U.S. Global Change Research Program, Washington, DC, USA, 1515 pp. doi:10.7930/NCA4.2018.

<sup>962</sup> IPCC, 2018: *Global Warming of 1.5°C*. An IPCC Special Report on the impacts of global warming of 1.5°C above pre-industrial levels and related global greenhouse gas emission pathways, in the context of strengthening the global response to the threat of climate change, sustainable development, and efforts to eradicate poverty [Masson-Delmotte, V., P. Zhai, H.-O. Pörtner, D. Roberts, J. Skea, P.R. Shukla, A. Pirani, W. Moufouma-Okia, C. Péan, R. Pidcock, S. Connors, J.B.R. Matthews, Y. Chen, X. Zhou, M.I. Gomis, E. Lonnoy, T. Maycock, M. Tignor, and T. Waterfield (eds.)].

<sup>963</sup> IPCC, 2019: *Climate Change and Land: an IPCC special report on climate change, desertification, land degradation, sustainable land management, food security, and greenhouse gas fluxes in terrestrial ecosystems* [P.R. Shukla, J. Skea, E. Calvo Buendia, V. Masson-Delmotte, H.-O. Pörtner, D. C. Roberts, P. Zhai, R. Slade, S. Connors, R. van Diemen, M. Ferrat, E. Haughey, S. Luz, S. Neogi, M. Pathak, J. Petzold, J. Portugal Pereira, P. Vyas, E. Huntley, K. Kissick, M. Belkacemi, J. Malley, (eds.)].

<sup>964</sup> IPCC, 2019: *IPCC Special Report on the Ocean and Cryosphere in a Changing Climate* [H.-O. Pörtner, D.C. Roberts, V. Masson-Delmotte, P. Zhai, M. Tignor, E. Poloczanska, K. Mintenbeck, A. Alegria, M. Nicolai, A. Okem, J. Petzold, B. Rama, N.M. Weyer (eds.)].

<sup>965</sup> IPCC, 2023: *Summary for Policymakers*. In: *Climate Change 2023: Synthesis Report*. Contribution of Working Groups I, II and III to the Sixth Assessment Report of the Intergovernmental Panel on Climate Change [Core Writing Team, H. Lee and J. Romero (eds.)]. IPCC, Geneva, Switzerland, pp. 1–34, doi:10.59327/IPCC/AR6–9789291691647.001.

<sup>966</sup> National Academies of Sciences, Engineering, and Medicine. 2016. *Attribution of Extreme Weather Events in the Context of Climate Change*. Washington, DC: The National Academies Press. <https://doi.org/10.17226/21852>.

<sup>967</sup> National Academies of Sciences, Engineering, and Medicine. 2017. *Valuing Climate Damages: Updating Estimation of the Social Cost of Carbon Dioxide*. Washington, DC: The National Academies Press. <https://doi.org/10.17226/24651>.

health and welfare both for current and future generations. These updated observations and projections document the rapid rate of current and future climate change both globally and in the U.S.<sup>959 960 961 962 963 964 965 966 967 968 969 970 971</sup>

The most recent information demonstrates that the climate is continuing to change in response to the human-induced buildup of GHGs in the atmosphere. These recent assessments show that atmospheric concentrations of GHGs have risen to a level that has no precedent in human history and that they continue to climb, primarily because of both historical and current anthropogenic emissions, and that these elevated concentrations endanger our health by affecting our food and water sources, the air we breathe, the weather we experience, and our interactions with the natural and built environments. For example, atmospheric concentrations of one of these GHGs, CO<sub>2</sub>, measured at Mauna Loa in Hawaii and at other sites around the world reached 419 parts per million (ppm) in 2022 (nearly 50 percent higher than preindustrial levels)<sup>972</sup> and have continued to rise at a rapid rate. Global average temperature has increased by about 1.1 °C (2.0 °F) in the 2011–2020 decade relative to 1850–1900.<sup>973</sup> The years 2015–2022 were the warmest 8 years in the 1880–2022 record.<sup>974</sup> The IPCC determined (with medium

<sup>968</sup> National Academies of Sciences, Engineering, and Medicine. 2019. *Climate Change and Ecosystems*. Washington, DC: The National Academies Press. <https://doi.org/10.17226/25504>.

<sup>969</sup> Blunden, J., T. Boyer, and E. Bartow-Gillies, Eds., 2023: “State of the Climate in 2022”. Bull. Amer. Meteor. Soc., 104 (9), Si–S501 <https://doi.org/10.1175/2023BAMSStateoftheClimate>.

<sup>970</sup> EPA. 2021. *Climate Change and Social Vulnerability in the United States: A Focus on Six Impacts*. U.S. Environmental Protection Agency, EPA 430–R–21–003.

<sup>971</sup> Jay, A.K., A.R. Crimmins, C.W. Avery, T.A. Dahl, R.S. Dodder, B.D. Hamlington, A. Lustig, K. Marvel, P.A. Méndez-Lazaro, M.S. Osler, A. Terando, E.S. Weeks, and A. Zycherman, 2023: Ch. 1. Overview: Understanding risks, impacts, and responses. In: *Fifth National Climate Assessment*. Crimmins, A.R., C.W. Avery, D.R. Easterling, K.E. Kunkel, B.C. Stewart, and T.K. Maycock, Eds. U.S. Global Change Research Program, Washington, DC, USA. <https://doi.org/10.7930/NCA5.2023.CH1>.

<sup>972</sup> [https://gml.noaa.gov/webdata/ccgg/trends/co2/co2\\_annmean\\_mlo.txt](https://gml.noaa.gov/webdata/ccgg/trends/co2/co2_annmean_mlo.txt).

<sup>973</sup> IPCC, 2021: *Summary for Policymakers*. In: *Climate Change 2021: The Physical Science Basis*. Contribution of Working Group I to the Sixth Assessment Report of the Intergovernmental Panel on Climate Change [Masson-Delmotte, V., P. Zhai, A. Pirani, S.L. Connors, C. Péan, S. Berger, N. Caud, Y. Chen, L. Goldfarb, M.I. Gomis, M. Huang, K. Leitzell, E. Lonnoy, J.B.R. Matthews, T.K. Maycock, T. Waterfield, O. Yelekçi, R. Yu, and B. Zhou (eds.)]. Cambridge University Press, Cambridge, United Kingdom and New York, NY, USA, pp. 3–32, doi:10.1017/9781009157896.001.

<sup>974</sup> Blunden, et al. 2023.

confidence) that this past decade was warmer than any multi-century period in at least the past 100,000 years.<sup>975</sup> Global average sea level has risen by about 8 inches (about 21 centimeters (cm)) from 1901 to 2018, with the rate from 2006 to 2018 (0.15 inches/year or 3.7 millimeters (mm)/year) almost twice the rate over the 1971 to 2006 period, and three times the rate of the 1901 to 2018 period.<sup>976</sup> The rate of sea level rise over the 20th century was higher than in any other century in at least the last 2,800 years.<sup>977</sup> Higher CO<sub>2</sub> concentrations have led to acidification of the surface ocean in recent decades to an extent unusual in the past 65 million years, with negative impacts on marine organisms that use calcium carbonate to build shells or skeletons.<sup>978</sup> Arctic sea ice extent continues to decline in all months of the year; the most rapid reductions occur in September (very likely almost a 13 percent decrease per decade between 1979 and 2018) and are unprecedented in at least 1,000 years.<sup>979</sup> Human-induced climate change has led to heatwaves and heavy precipitation becoming more frequent and more intense, along with increases in agricultural and ecological droughts<sup>980</sup> in many regions.<sup>981</sup>

The assessment literature demonstrates that modest additional amounts of warming may lead to a climate different from anything humans have ever experienced. The 2022 CO<sub>2</sub> concentration of 419 ppm is already higher than at any time in the last 2 million years.<sup>982</sup> If concentrations exceed 450 ppm, they would likely be higher than any time in the past 23 million years:<sup>983</sup> at the current rate of increase of more than 2 ppm a year, this would occur in about 15 years. While GHGs are not the only factor that controls climate, it is illustrative that 3 million years ago (the last time CO<sub>2</sub> concentrations were above 400 ppm) Greenland was not yet completely covered by ice and still supported

forests, while 23 million years ago (the last time concentrations were above 450 ppm) the West Antarctic ice sheet was not yet developed, indicating the possibility that high GHG concentrations could lead to a world that looks very different from today and from the conditions in which human civilization has developed. If the Greenland and Antarctic ice sheets were to melt substantially, sea levels would rise dramatically—the IPCC estimated that over the next 2,000 years, sea level will rise by 7 to 10 feet even if warming is limited to 1.5 °C (2.7 °F), from 7 to 20 feet if limited to 2 °C (3.6 °F), and by 60 to 70 feet if warming is allowed to reach 5 °C (9 °F) above preindustrial levels.<sup>984</sup> For context, almost all of the city of Miami is less than 25 feet above sea level, and the 4th National Climate Assessment (NCA4) stated that 13 million Americans would be at risk of migration due to 6 feet of sea level rise.

The NCA4 found that it is very likely (greater than 90 percent likelihood) that by mid-century, the Arctic Ocean will be almost entirely free of sea ice by late summer for the first time in about 2 million years.<sup>985</sup> Coral reefs will be at risk for almost complete (99 percent) losses with 1 °C (1.8 °F) of additional warming from today (2 °C or 3.6 °F since preindustrial). At this temperature, between 8 and 18 percent of animal, plant, and insect species could lose over half of the geographic area with suitable climate for their survival, and 7 to 10 percent of rangeland livestock would be projected to be lost.<sup>986</sup> The IPCC similarly found that climate change has caused substantial damages and increasingly irreversible losses in terrestrial, freshwater, and coastal and open ocean marine ecosystems.

Every additional increment of temperature comes with consequences. For example, the half degree of warming from 1.5 to 2 °C (0.9 °F of warming from 2.7 °F to 3.6 °F) above preindustrial temperatures is projected on a global scale to expose 420 million more people to extreme heatwaves at least once every five years, and 62 million more people to exceptional heatwaves at least once every five years (where heatwaves are defined based on a heat wave magnitude index which takes into account duration and intensity—using this index, the 2003 French heat wave that led to almost 15,000 deaths would be classified as an “extreme heatwave” and the 2010 Russian heatwave which led to thousands of deaths and extensive wildfires would be classified as

“exceptional”). It would increase the frequency of sea-ice-free Arctic summers from once in 100 years to once in a decade. It could lead to 4 inches of additional sea level rise by the end of the century, exposing an additional 10 million people to risks of inundation as well as increasing the probability of triggering instabilities in either the Greenland or Antarctic ice sheets. Between half a million and a million additional square miles of permafrost would thaw over several centuries. Risks to food security would increase from medium to high for several lower-income regions in the Sahel, southern Africa, the Mediterranean, central Europe, and the Amazon. In addition to food security issues, this temperature increase would have implications for human health in terms of increasing ozone concentrations, heatwaves, and vector-borne diseases (for example, expanding the range of the mosquitoes which carry dengue fever, chikungunya, yellow fever, and the Zika virus, or the ticks which carry Lyme, babesiosis, or Rocky Mountain Spotted Fever).<sup>987</sup> Moreover, every additional increment in warming leads to larger changes in extremes, including the potential for events unprecedented in the observational record. Every additional degree will intensify extreme precipitation events by about 7 percent. The peak winds of the most intense tropical cyclones (hurricanes) are projected to increase with warming. In addition to a higher intensity, the IPCC found that precipitation and frequency of rapid intensification of these storms has already increased, the movement speed has decreased, and elevated sea levels have increased coastal flooding, all of which make these tropical cyclones more damaging.<sup>988</sup>

The NCA4 also evaluated a number of impacts specific to the U.S. Severe drought and outbreaks of insects like the mountain pine beetle have killed hundreds of millions of trees in the western U.S. Wildfires have burned more than 3.7 million acres in 14 of the 17 years between 2000 and 2016, and Federal wildfire suppression costs were about a billion dollars annually.<sup>989</sup> The National Interagency Fire Center has documented U.S. wildfires since 1983, and the 10 years with the largest acreage burned have all occurred since 2004.<sup>990</sup> Wildfire smoke degrades air quality, increasing health risks, and more

<sup>975</sup> IPCC, 2021.

<sup>976</sup> IPCC, 2021.

<sup>977</sup> USGCRP, 2018: *Impacts, Risks, and Adaptation in the United States: Fourth National Climate Assessment, Volume II* [Reidmiller, D.R., C.W. Avery, D.R. Easterling, K.E. Kunkel, K.L.M. Lewis, T.K. Maycock, and B.C. Stewart (eds.)]. U.S. Global Change Research Program, Washington, DC, USA, 1515 pp. doi:10.7930/NCA4.2018.

<sup>978</sup> IPCC, 2018.

<sup>979</sup> IPCC, 2021.

<sup>980</sup> These are drought measures based on soil moisture.

<sup>981</sup> IPCC, 2021.

<sup>982</sup> Annual Mauna Loa CO<sub>2</sub> concentration data from [https://gml.noaa.gov/webdata/ccgg/trends/co2/co2\\_annmean\\_mlo.txt](https://gml.noaa.gov/webdata/ccgg/trends/co2/co2_annmean_mlo.txt), accessed September 9, 2023.

<sup>983</sup> IPCC, 2013.

<sup>984</sup> IPCC, 2021.

<sup>985</sup> USGCRP, 2018.

<sup>986</sup> IPCC, 2018.

<sup>987</sup> IPCC, 2018.

<sup>988</sup> IPCC, 2021.

<sup>989</sup> USGCRP, 2018.

<sup>990</sup> NIFC (National Interagency Fire Center). 2021. Total wildland fires and acres (1983–2020). Accessed August 2021. [www.nifc.gov/fireInfo/fireInfo\\_stats\\_totalFires.html](http://www.nifc.gov/fireInfo/fireInfo_stats_totalFires.html).

frequent and severe wildfires due to climate change would further diminish air quality, increase incidences of respiratory illness, impair visibility, and disrupt outdoor activities, sometimes thousands of miles from the location of the fire. Meanwhile, sea level rise has amplified coastal flooding and erosion impacts, requiring the installation of costly pump stations, flooding streets, and increasing storm surge damages. Tens of billions of dollars of U.S. real estate could be below sea level by 2050 under some scenarios. Increased frequency and duration of drought will reduce agricultural productivity in some regions, accelerate depletion of water supplies for irrigation, and expand the distribution and incidence of pests and diseases for crops and livestock. The NCA4 also recognized that climate change can increase risks to national security, both through direct impacts on military infrastructure and by affecting factors such as food and water availability that can exacerbate conflict outside U.S. borders. Droughts, floods, storm surges, wildfires, and other extreme events stress nations and people through loss of life, displacement of populations, and impacts on livelihoods.<sup>991</sup>

EPA modeling efforts can further illustrate how these impacts from climate change may be experienced across the U.S. EPA's Framework for Evaluating Damages and Impacts (FrEDI)<sup>992</sup> uses information from over 30 peer-reviewed climate change impact studies to project the physical and economic impacts of climate change to the U.S. resulting from future temperature changes. These impacts are projected for specific regions within the U.S. and for more than 20 impact categories, which span a large number of sectors of the U.S. economy.<sup>993</sup> Using

this framework, the EPA estimates that global emission projections, with no additional mitigation, will result in significant climate-related damages to the U.S.<sup>994</sup> These damages to the U.S. would mainly be from increases in lives lost due to increases in temperatures, as well as impacts to human health from increases in climate-driven changes in air quality, dust and wildfire smoke exposure, and incidence of suicide. Additional major climate-related damages would occur to U.S. infrastructure such as roads and rail, as well as transportation impacts and coastal flooding from sea level rise, increases in property damage from tropical cyclones, and reductions in labor hours worked in outdoor settings and buildings without air conditioning. These impacts are also projected to vary from region to region with the Southeast, for example, projected to see some of the largest damages from sea level rise, the West Coast projected to experience damages from wildfire smoke more than other parts of the country, and the Northern Plains states projected to see a higher proportion of damages to rail and road infrastructure. While information on the distribution of climate impacts helps to better understand the ways in which climate change may impact the U.S., recent analyses are still only a partial assessment of climate impacts relevant to U.S. interests and do not reflect increased damages that occur due to interactions between different sectors impacted by climate change or all the ways in which physical impacts of climate change occurring abroad have spillover effects in different regions of the U.S.

Some GHGs also have impacts beyond those mediated through climate change. For example, elevated concentrations of CO<sub>2</sub> stimulate plant growth (which can be positive in the case of beneficial species, but negative in terms of weeds and invasive species, and can also lead to a reduction in plant micronutrients<sup>995</sup>) and cause ocean acidification. Nitrous oxide depletes the

[www.epa.gov/cira/fredi](http://www.epa.gov/cira/fredi). Documentation has been subject to both a public review comment period and an independent expert peer review, following EPA peer-review guidelines.

<sup>994</sup> Compared to a world with no additional warming after the model baseline (1986–2005).

<sup>995</sup> Ziska, L., A. Crimmins, A. Auclair, S. DeGrasse, J.F. Garofalo, A.S. Khan, I. Loladze, A.A. Pérez de León, A. Showler, J. Thurston, and I. Walls, 2016: Ch. 7: *Food Safety, Nutrition, and Distribution. The Impacts of Climate Change on Human Health in the United States: A Scientific Assessment*. U.S. Global Change Research Program, Washington, DC, 189–216. [https://health2016.globalchange.gov/low/ClimateHealth2016\\_07\\_Food\\_small.pdf](https://health2016.globalchange.gov/low/ClimateHealth2016_07_Food_small.pdf).

levels of protective stratospheric ozone.<sup>996</sup>

Transportation is the largest U.S. source of GHG emissions, representing 29 percent of total GHG emissions.<sup>997</sup> Within the transportation sector, heavy-duty vehicles are the second largest contributor to GHG emissions and are responsible for 25 percent of GHG emissions in the sector.<sup>998</sup> The GHG emission reductions resulting from compliance with this final rule will significantly reduce the volume of GHG emissions from this sector. Section VI.D.2 of this preamble discusses impacts of GHG emissions on individuals living in socially and economically vulnerable communities. While EPA did not conduct modeling to specifically quantify changes in climate impacts resulting from this rule in terms of avoided temperature change or sea-level rise, we did quantify climate benefits by monetizing the emission reductions through the application of estimates of the social cost of greenhouse gases (SC-GHGs), as described in section VII.A of this preamble.

These scientific assessments, the EPA analyses, and documented observed changes in the climate of the planet and of the U.S. present clear support regarding the current and future dangers of climate change and the importance of GHG emissions mitigation.

#### *B. Health and Environmental Effects Associated With Exposure to Non-GHG Pollutants*

The non-GHG emissions that will be impacted by this rule contribute, directly or via secondary formation, to concentrations of pollutants in the air which affect human and environmental health. These pollutants include particulate matter, ozone, sulfur oxides, carbon monoxide and air toxics.

#### *1. Background on Criteria and Air Toxics Pollutants Impacted by This Rule*

##### *i. Particulate Matter*

Particulate matter (PM) is a complex mixture of solid particles and liquid droplets distributed among numerous atmospheric gases which interact with solid and liquid phases. Particles in the atmosphere range in size from less than 0.01 to more than 10 micrometers (µm)

<sup>996</sup> WMO (World Meteorological Organization), *Scientific Assessment of Ozone Depletion: 2018, Global Ozone Research and Monitoring Project—Report No. 58*, 588 pp., Geneva, Switzerland, 2018.

<sup>997</sup> EPA (2023). *Inventory of U.S. Greenhouse Gas Emissions and Sinks: 1990–2021* (EPA-430-R-23-002, published April 2023).

<sup>998</sup> EPA (2023). *Inventory of U.S. Greenhouse Gas Emissions and Sinks: 1990–2021* (EPA-430-R-23-002, published April 2023).

<sup>991</sup> USGCRP, 2018.

<sup>992</sup> (1) Hartin, C., et al. (2023). Advancing the estimation of future climate impacts within the United States. *Earth Syst. Dynam.*, 14, 1015–1037, <https://doi.org/10.5194/esd-14-1015-2023>. (2) *Supplementary Material for the Regulatory Impact Analysis for the Supplemental Proposed Rulemaking, “Standards of Performance for New, Reconstructed, and Modified Sources and Emissions Guidelines for Existing Sources: Oil and Natural Gas Sector Climate Review,”* Docket ID No. EPA-HQ-OAR-2021-0317, September 2022, (3) *The Long-Term Strategy of the United States: Pathways to Net-Zero Greenhouse Gas Emissions by 2050*. Published by the U.S. Department of State and the U.S. Executive Office of the President, Washington, DC. November 2021, (4) *Climate Risk Exposure: An Assessment of the Federal Government's Financial Risks to Climate Change*, White Paper, Office of Management and Budget, April 2022.

<sup>993</sup> EPA (2021). *Technical Documentation on the Framework for Evaluating Damages and Impacts (FrEDI)*. U.S. Environmental Protection Agency, EPA 430-R-21-004, available at <https://>

in diameter.<sup>999</sup> Atmospheric particles can be grouped into several classes according to their aerodynamic diameter and physical sizes. Generally, the three broad classes of particles include ultrafine particles (UFPs, generally considered as particles with a diameter less than or equal to 0.1 μm [typically based on physical size, thermal diffusivity, or electrical mobility]), “fine” particles (PM<sub>2.5</sub>; particles with a nominal mean aerodynamic diameter less than or equal to 2.5 μm), and “thoracic” particles (PM<sub>10</sub>; particles with a nominal mean aerodynamic diameter less than or equal to 10 μm). Particles that fall within the size range between PM<sub>2.5</sub> and PM<sub>10</sub>, are referred to as “thoracic coarse particles” (PM<sub>10–2.5</sub>, particles with a nominal mean aerodynamic diameter greater than 2.5 μm and less than or equal to 10 μm). EPA currently has NAAQS for PM<sub>2.5</sub> and PM<sub>10</sub>.<sup>1000</sup>

Most particles are found in the lower troposphere, where they can have residence times ranging from a few hours to weeks. Particles are removed from the atmosphere by wet deposition, such as when they are carried by rain or snow, or by dry deposition, when particles settle out of suspension due to gravity. Atmospheric lifetimes are generally longest for PM<sub>2.5</sub>, which often remains in the atmosphere for days to weeks before being removed by wet or dry deposition.<sup>1001</sup> In contrast, atmospheric lifetimes for UFP and PM<sub>10–2.5</sub> are shorter. Within hours, UFP can undergo coagulation and condensation that lead to formation of larger particles in the accumulation mode or can be removed from the atmosphere by evaporation, deposition, or reactions with other atmospheric components. PM<sub>10–2.5</sub> are also generally removed from the atmosphere within hours through wet or dry deposition.<sup>1002</sup>

<sup>999</sup> U.S. EPA. Policy Assessment (PA) for the Review of the National Ambient Air Quality Standards for Particulate Matter (Final Report, 2020). U.S. Environmental Protection Agency, Washington, DC, EPA/452/R–20/002, 2020.

<sup>1000</sup> Regulatory definitions of PM size fractions, and information on reference and equivalent methods for measuring PM in ambient air, are provided in 40 CFR parts 50, 53, and 58. With regard to NAAQS which provide protection against health and welfare effects, the 24-hour PM<sub>10</sub> standard provides protection against effects associated with short-term exposure to thoracic coarse particles (*i.e.*, PM<sub>10–2.5</sub>).

<sup>1001</sup> U.S. EPA. Integrated Science Assessment (ISA) for Particulate Matter (Final Report, 2019). U.S. Environmental Protection Agency, Washington, DC, EPA/600/R–19/188, 2019. Table 2–1.

<sup>1002</sup> U.S. EPA. Integrated Science Assessment (ISA) for Particulate Matter (Final Report, 2019). U.S. Environmental Protection Agency, Washington, DC, EPA/600/R–19/188, 2019. Table 2–1.

Particulate matter consists of both primary and secondary particles. Primary particles are emitted directly from sources, such as combustion-related activities (*e.g.*, industrial activities, motor vehicle operation, biomass burning), while secondary particles are formed through atmospheric chemical reactions of gaseous precursors (*e.g.*, sulfur oxides (SO<sub>x</sub>), oxides of nitrogen (NO<sub>x</sub>) and volatile organic compounds (VOCs)).

ii. Ozone

Ground-level ozone pollution forms in areas with high concentrations of ambient NO<sub>x</sub> and VOCs when solar radiation is strong. Major U.S. sources of NO<sub>x</sub> are highway and nonroad motor vehicles, engines, power plants and other industrial sources; natural sources, such as soil, vegetation, and lightning, are smaller sources. Vegetation is the dominant source of VOCs in the United States. Volatile consumer and commercial products, such as propellants and solvents, highway and nonroad vehicles, engines, fires, and industrial sources also contribute to the atmospheric burden of VOCs at ground-level.

The processes underlying ozone formation, transport, and accumulation are complex. Ground-level ozone is produced and destroyed by an interwoven network of free radical reactions involving the hydroxyl radical (OH), NO, NO<sub>2</sub>, and complex reaction intermediates derived from VOCs. Many of these reactions are sensitive to temperature and available sunlight. High ozone events most often occur when ambient temperatures and sunlight intensities remain high for several days under stagnant conditions. Ozone and its precursors can also be transported hundreds of miles downwind, which can lead to elevated ozone levels in areas with otherwise low VOC or NO<sub>x</sub> emissions. As an air mass moves and is exposed to changing ambient concentrations of NO<sub>x</sub> and VOCs, the ozone photochemical regime (relative sensitivity of ozone formation to NO<sub>x</sub> and VOC emissions) can change.

When ambient VOC concentrations are high, comparatively small amounts of NO<sub>x</sub> catalyze rapid ozone formation. Without available NO<sub>x</sub>, ground-level ozone production is severely limited, and VOC reductions would have little impact on ozone concentrations. Photochemistry under these conditions is said to be “NO<sub>x</sub>-limited.” When NO<sub>x</sub> levels are sufficiently high, faster NO<sub>2</sub> oxidation consumes more radicals, dampening ozone production. Under these “VOC-limited” conditions (also referred to as “NO<sub>x</sub>-saturated”

conditions), VOC reductions are effective in reducing ozone, and NO<sub>x</sub> can react directly with ozone, resulting in suppressed ozone concentrations near NO<sub>x</sub> emission sources. Under these NO<sub>x</sub>-saturated conditions, NO<sub>x</sub> reductions can increase local ozone under certain circumstances, but overall ozone production (considering downwind formation) decreases and, even in VOC-limited areas, NO<sub>x</sub> reductions are not expected to increase ozone levels if the NO<sub>x</sub> reductions are sufficiently large—large enough for photochemistry to become NO<sub>x</sub>-limited.

iii. Oxides of nitrogen (NO<sub>x</sub>) refers to nitric oxide (NO) and nitrogen dioxide (NO<sub>2</sub>). Most NO<sub>2</sub> is formed in the air through the oxidation of NO emitted when fuel is burned at a high temperature. NO<sub>2</sub> is a criteria pollutant, regulated for its adverse effects on public health and the environment, and highway vehicles are an important contributor to NO<sub>2</sub> emissions. NO<sub>x</sub>, along with VOCs, are the two major precursors of ozone, and NO<sub>x</sub> is also a major contributor to secondary PM<sub>2.5</sub> formation.

iv. Sulfur Oxides

Sulfur dioxide (SO<sub>2</sub>), a member of the sulfur oxide (SO<sub>x</sub>) family of gases, is formed from burning fuels containing sulfur (*e.g.*, coal or oil), extracting gasoline from oil, or extracting metals from ore. SO<sub>2</sub> and its gas phase oxidation products can dissolve in water droplets and further oxidize to form sulfuric acid which reacts with ammonia to form sulfates, which are important components of ambient PM.

v. Carbon Monoxide

Carbon monoxide (CO) is a colorless, odorless gas formed by incomplete combustion of carbon-containing fuels and by photochemical reactions in the atmosphere. Nationally, particularly in urban areas, the majority of CO emissions to ambient air come from mobile sources.<sup>1003</sup>

vi. Diesel Exhaust

Diesel exhaust is a complex mixture composed of particulate matter, carbon dioxide, oxygen, nitrogen, water vapor, carbon monoxide, nitrogen compounds, sulfur compounds and numerous low-molecular-weight hydrocarbons. A number of these gaseous hydrocarbon

<sup>1003</sup> U.S. EPA, (2010). Integrated Science Assessment for Carbon Monoxide (Final Report). U.S. Environmental Protection Agency, Washington, DC, EPA/600/R–09/019F, 2010. <http://cfpub.epa.gov/ncea/cfm/recordisplay.cfm?deid=218686>. See section 2.1.



components are individually known to be toxic, including aldehydes, benzene and 1,3-butadiene. The diesel particulate matter present in diesel exhaust consists mostly of fine particles (less than 2.5 µm), of which a significant fraction is ultrafine particles (less than 0.1 µm). These particles have a large surface area which makes them an excellent medium for adsorbing organics, and their small size makes them highly respirable. Many of the organic compounds present in the gases and on the particles, such as polycyclic organic matter, are individually known to have mutagenic and carcinogenic properties.

Diesel exhaust varies significantly in chemical composition and particle sizes between different engine types (heavy-duty, light-duty), engine operating conditions (idle, acceleration, deceleration), and fuel formulations (high/low sulfur fuel). Also, there are emissions differences between on-road and nonroad engines because the nonroad engines are generally of older technology. After being emitted in the engine exhaust, diesel exhaust undergoes dilution as well as chemical and physical changes in the atmosphere. The lifetimes of the components present in diesel exhaust range from seconds to months.

vii. Air Toxics

The most recent available data indicate that millions of Americans live in areas where air toxics pose potential health concerns.<sup>1004</sup> <sup>1005</sup> The levels of air toxics to which people are exposed vary depending on where people live and work and the kinds of activities in which they engage, as discussed in detail in EPA's 2007 Mobile Source Air Toxics Rule.<sup>1006</sup> According to EPA's 2017 National Emissions Inventory (NEI), mobile sources were responsible for 39 percent of outdoor anthropogenic toxic emissions. Further, mobile sources were the largest contributor to national average risk of cancer and immunological and respiratory health effects from directly emitted pollutants, according to EPA's Air Toxics Screening

Assessment (AirToxScreen) for 2019.<sup>1007</sup> <sup>1008</sup> Mobile sources are also significant contributors to precursor emissions which react to form air toxics.<sup>1009</sup> Formaldehyde is the largest contributor to cancer risk of all 72 pollutants quantitatively assessed in the 2019 AirToxScreen. Mobile sources were responsible for 26 percent of primary anthropogenic emissions of this pollutant in the 2017 NEI and are significant contributors to formaldehyde precursor emissions. Benzene is also a large contributor to cancer risk, and mobile sources account for about 60 percent of average exposure to ambient concentrations.

2. Health Effects Associated With Exposure to Non-GHG Pollutants

Heavy-duty vehicles emit non-GHG pollutants that contribute to ambient concentrations of ozone, PM, NO<sub>2</sub>, SO<sub>2</sub>, CO, and air toxics. This section of the preamble discusses the health effects associated with exposure to these pollutants. Although the discussion which follows largely deals with the effects of these pollutants on the general population, we note at the outset that certain populations are especially vulnerable and susceptible to effects from exposure to these pollutants. Children are one such population, and they are especially vulnerable because they generally breathe more relative to their size than adults; consequently, they may be exposed to relatively higher amounts of air pollution.<sup>1010</sup> Children also tend to breathe through their mouths more than adults, and their nasal passages are less effective at removing pollutants, which leads to greater lung deposition of some pollutants such as PM.<sup>1011</sup> <sup>1012</sup>

<sup>1007</sup> U.S. EPA. (2022) 2019 AirToxScreen: Assessment Results. <https://www.epa.gov/AirToxScreen/2019-airtoxscreen-assessment-results>.

<sup>1008</sup> AirToxScreen also includes estimates of risk attributable to background concentrations, which includes contributions from long-range transport, persistent air toxics, and natural sources; as well as secondary concentrations, where toxics are formed via secondary formation. Mobile sources substantially contribute to long-range transport and secondarily formed air toxics.

<sup>1009</sup> Rich Cook, Sharon Phillips, Madeleine Strum, Alison Eyth & James Thurman (2020): Contribution of mobile sources to secondary formation of carbonyl compounds, Journal of the Air & Waste Management Association, DOI: 10.1080/10962247.2020.1813839.

<sup>1010</sup> EPA (2009) Metabolically-derived ventilation rates: A revised approach based upon oxygen consumption rates. Washington, DC: Office of Research and Development. EPA/600/R-06/129F. [http://cfpub.epa.gov/nceda/cfm/recor\\_display.cfm?deid=202543](http://cfpub.epa.gov/nceda/cfm/recor_display.cfm?deid=202543).

<sup>1011</sup> U.S. EPA Integrated Science Assessment for Particulate Matter (Final Report, 2019). U.S. Environmental Protection Agency, Washington, DC, EPA/600/R-19/188, 2019. Chapter 4 "Overall Conclusions" p. 4-1.

Furthermore, air pollutants may pose health risks specific to children because children's bodies are still developing.<sup>1013</sup> For example, during periods of rapid growth such as fetal development, infancy and puberty, their developing systems and organs may be more easily harmed.<sup>1014</sup> <sup>1015</sup> See EPA's Report "America's Children and the Environment," which presents national trends on air pollution and other contaminants and environmental health of children.<sup>1016</sup>

i. Particulate Matter

Scientific evidence spanning animal toxicological, controlled human exposure, and epidemiologic studies shows that exposure to ambient PM is associated with a broad range of health effects. These health effects are discussed in detail in the Integrated Science Assessment for Particulate Matter, which was finalized in December 2019 (2019 p.m. ISA), with a more targeted evaluation of studies published since the literature cutoff date of the 2019 p.m. ISA in the Supplement to the Integrated Science Assessment for PM (Supplement).<sup>1017</sup> <sup>1018</sup> The PM ISA characterizes the causal nature of relationships between PM exposure and broad health categories (e.g., cardiovascular effects, respiratory effects, etc.) using a weight-of-evidence approach.<sup>1019</sup> Within this

<sup>1012</sup> Foos, B.; Marty, M.; Schwartz, J.; Bennet, W.; Moya, J.; Jarabek, A.M.; Salmon, A.G. (2008) Focusing on children's inhalation dosimetry and health effects for risk assessment: An introduction. J Toxicol Environ Health 71A: 149-165.

<sup>1013</sup> Children's environmental health includes conception, infancy, early childhood and through adolescence until 21 years of age as described in the EPA Memorandum: Issuance of EPA's 2021 Policy on Children's Health. October 5, 2021. Available at <https://www.epa.gov/system/files/documents/2021-10/2021-policy-on-childrens-health.pdf>.

<sup>1014</sup> EPA (2006) A Framework for Assessing Health Risks of Environmental Exposures to Children. EPA, Washington, DC, EPA/600/R-05/093F, 2006.

<sup>1015</sup> U.S. Environmental Protection Agency. (2005). Supplemental guidance for assessing susceptibility from early-life exposure to carcinogens. Washington, DC: Risk Assessment Forum. EPA/630/R-03/003F. [https://www3.epa.gov/airtoxics/childrens\\_supplement\\_final.pdf](https://www3.epa.gov/airtoxics/childrens_supplement_final.pdf).

<sup>1016</sup> U.S. EPA. America's Children and the Environment. Available at: <https://www.epa.gov/americaschildrenenvironment>.

<sup>1017</sup> U.S. EPA. Integrated Science Assessment (ISA) for Particulate Matter (Final Report, 2019). U.S. Environmental Protection Agency, Washington, DC, EPA/600/R-19/188, 2019.

<sup>1018</sup> U.S. EPA. Supplement to the 2019 Integrated Science Assessment for Particulate Matter (Final Report, 2022). U.S. Environmental Protection Agency, Washington, DC, EPA/635/R-22/028, 2022.

<sup>1019</sup> The causal framework draws upon the assessment and integration of evidence from across scientific disciplines, spanning atmospheric chemistry, exposure, dosimetry and health effects

Continued

characterization, the PM ISA summarizes the health effects evidence for short-term (*i.e.*, hours up to one month) and long-term (*i.e.*, one month to years) exposures to PM<sub>2.5</sub>, PM<sub>10-2.5</sub>, and ultrafine particles and concludes that exposures to ambient PM<sub>2.5</sub> are associated with a number of adverse health effects. The discussion in this section VI.B.2.i highlights the PM ISA's conclusions and summarizes additional information from the Supplement where appropriate, pertaining to the health effects evidence for both short- and long-term PM exposures. Further discussion of PM-related health effects can also be found in the 2022 Policy Assessment for the review of the PM NAAQS.<sup>1020</sup>

EPA has concluded that recent evidence in combination with evidence evaluated in the 2009 p.m. ISA supports a “causal relationship” between both long- and short-term exposures to PM<sub>2.5</sub> and premature mortality and cardiovascular effects and a “likely to be causal relationship” between long- and short-term PM<sub>2.5</sub> exposures and respiratory effects.<sup>1021</sup> Additionally, recent experimental and epidemiologic studies provide evidence supporting a “likely to be causal relationship” between long-term PM<sub>2.5</sub> exposure and nervous system effects and between long-term PM<sub>2.5</sub> exposure and cancer. Because of remaining uncertainties and limitations in the evidence base, EPA determined a “suggestive of, but not sufficient to infer, a causal relationship” for long-term PM<sub>2.5</sub> exposure and reproductive and developmental effects (*i.e.*, male/female reproduction and fertility; pregnancy and birth outcomes), long- and short-term exposures and

studies (*i.e.*, epidemiologic, controlled human exposure, and animal toxicological studies), and assess the related uncertainties and limitations that ultimately influence our understanding of the evidence. This framework employs a five-level hierarchy that classifies the overall weight-of-evidence with respect to the causal nature of relationships between criteria pollutant exposures and health and welfare effects using the following categorizations: causal relationship; likely to be causal relationship; suggestive of, but not sufficient to infer, a causal relationship; inadequate to infer the presence or absence of a causal relationship; and not likely to be a causal relationship (U.S. EPA) (2019). Integrated Science Assessment for Particulate Matter (Final Report). U.S. Environmental Protection Agency, Washington, DC, EPA/600/R-19/188, Section P. 3.2.3).

<sup>1020</sup> U.S. EPA. Policy Assessment (PA) for the Reconsideration of the National Ambient Air Quality Standards for Particulate Matter (Final Report, 2022). U.S. Environmental Protection Agency, Washington, DC, EPA-452/R-22-004, 2022.

<sup>1021</sup> U.S. EPA (2009). Integrated Science Assessment for Particulate Matter (Final Report). U.S. Environmental Protection Agency, Washington, DC, EPA/600/R-08/139F.

metabolic effects, and short-term exposure and nervous system effects.

As discussed extensively in the 2019 p.m. ISA and the Supplement, recent studies continue to support a “causal relationship” between short- and long-term PM<sub>2.5</sub> exposures and mortality.<sup>1022 1023</sup> For short-term PM<sub>2.5</sub> exposure, multi-city studies, in combination with single- and multi-city studies evaluated in the 2009 p.m. ISA, provide evidence of consistent, positive associations across studies conducted in different geographic locations, populations with different demographic characteristics, and studies using different exposure assignment techniques. Additionally, the consistent and coherent evidence across scientific disciplines for cardiovascular morbidity, including exacerbations of chronic obstructive pulmonary disease (COPD) and asthma, provide biological plausibility for cause-specific mortality and ultimately total mortality. Recent epidemiologic studies evaluated in the Supplement, including studies that employed alternative methods for confounder control, provide additional support to the evidence base that contributed to the 2019 p.m. ISA conclusion for short-term PM<sub>2.5</sub> exposure and mortality.

The 2019 p.m. ISA concluded a “causal relationship” between long-term PM<sub>2.5</sub> exposure and mortality. In addition to reanalyzes and extensions of the American Cancer Society (ACS) and Harvard Six Cities (HSC) cohorts, multiple new cohort studies conducted in the United States and Canada consisting of people employed in a specific job (*e.g.*, teacher, nurse), and that apply different exposure assignment techniques, provide evidence of positive associations between long-term PM<sub>2.5</sub> exposure and mortality. Biological plausibility for mortality due to long-term PM<sub>2.5</sub> exposure is provided by the coherence of effects across scientific disciplines for cardiovascular morbidity, particularly for coronary heart disease, stroke, and atherosclerosis, and for respiratory morbidity, particularly for the development of COPD. Additionally, recent studies provide evidence indicating that as long-term PM<sub>2.5</sub> concentrations decrease there is an increase in life expectancy. Recent cohort studies evaluated in the

<sup>1022</sup> U.S. EPA. Integrated Science Assessment (ISA) for Particulate Matter (Final Report, 2019). U.S. Environmental Protection Agency, Washington, DC, EPA/600/R-19/188, 2019.

<sup>1023</sup> U.S. EPA. Supplement to the 2019 Integrated Science Assessment for Particulate Matter (Final Report, 2022). U.S. Environmental Protection Agency, Washington, DC, EPA/635/R-22/028, 2022.

Supplement, as well as epidemiologic studies that conducted accountability analyses or employed alternative methods for confounder controls, support and extend the evidence base that contributed to the 2019 p.m. ISA conclusion for long-term PM<sub>2.5</sub> exposure and mortality.

A large body of studies examining both short- and long-term PM<sub>2.5</sub> exposure and cardiovascular effects supports and extends the evidence base evaluated in the 2009 p.m. ISA. The strongest evidence for cardiovascular effects in response to short-term PM<sub>2.5</sub> exposures is for ischemic heart disease and heart failure. The evidence for short-term PM<sub>2.5</sub> exposure and cardiovascular effects is coherent across scientific disciplines and supports a continuum of effects ranging from subtle changes in indicators of cardiovascular health to serious clinical events, such as increased emergency department visits and hospital admissions due to cardiovascular disease and cardiovascular mortality. For long-term PM<sub>2.5</sub> exposure, there is strong and consistent epidemiologic evidence of a relationship with cardiovascular mortality. This evidence is supported by epidemiologic and animal toxicological studies demonstrating a range of cardiovascular effects including coronary heart disease, stroke, impaired heart function, and subclinical markers (*e.g.*, coronary artery calcification, atherosclerotic plaque progression), which collectively provide coherence and biological plausibility. Recent epidemiologic studies evaluated in the Supplement, as well as studies that conducted accountability analyses or employed alternative methods for confounder control, support and extend the evidence base that contributed to the 2019 p.m. ISA conclusion for both short- and long-term PM<sub>2.5</sub> exposure and cardiovascular effects.

Studies evaluated in the 2019 PM ISA continue to provide evidence of a “likely to be causal relationship” between both short- and long-term PM<sub>2.5</sub> exposure and respiratory effects. Epidemiologic studies provide consistent evidence of a relationship between short-term PM<sub>2.5</sub> exposure and asthma exacerbation in children and COPD exacerbation in adults as indicated by increases in emergency department visits and hospital admissions, which is supported by animal toxicological studies indicating worsening allergic airways disease and subclinical effects related to COPD. Epidemiologic studies also provide evidence of a relationship between short-term PM<sub>2.5</sub> exposure and respiratory mortality. However, there is

inconsistent evidence of respiratory effects, specifically lung function declines and pulmonary inflammation, in controlled human exposure studies. With respect to long term PM<sub>2.5</sub> exposure, epidemiologic studies conducted in the United States and abroad provide evidence of a relationship with respiratory effects, including consistent changes in lung function and lung function growth rate, increased asthma incidence, asthma prevalence, and wheeze in children; acceleration of lung function decline in adults; and respiratory mortality. The epidemiologic evidence is supported by animal toxicological studies, which provide coherence and biological plausibility for a range of effects including impaired lung development, decrements in lung function growth, and asthma development.

Since the 2009 PM ISA, a growing body of scientific evidence examined the relationship between long-term PM<sub>2.5</sub> exposure and nervous system effects, resulting for the first time in a causality determination for this health effects category of a “likely to be causal relationship.” The strongest evidence for effects on the nervous system comes from epidemiologic studies that consistently report cognitive decrements and reductions in brain volume in adults. The effects observed in epidemiologic studies in adults are supported by animal toxicological studies demonstrating effects on the brain of adult animals including inflammation, morphologic changes, and neurodegeneration of specific regions of the brain. There is more limited evidence for neurodevelopmental effects in children, with some studies reporting positive associations with autism spectrum disorder and others providing limited evidence of an association with cognitive function. While there is some evidence from animal toxicological studies indicating effects on the brain (*i.e.*, inflammatory and morphological changes) to support a biologically plausible pathway for neurodevelopmental effects, epidemiologic studies are limited due to their lack of control for potential confounding by copollutants, the small number of studies conducted, and uncertainty regarding critical exposure windows.

Building off the decades of research demonstrating mutagenicity, DNA damage, and other endpoints related to genotoxicity due to whole PM exposures, recent experimental and epidemiologic studies focusing specifically on PM<sub>2.5</sub> provide evidence of a relationship between long-term

PM<sub>2.5</sub> exposure and cancer. Epidemiologic studies examining long-term PM<sub>2.5</sub> exposure and lung cancer incidence and mortality provide evidence of generally positive associations in cohort studies spanning different populations, locations, and exposure assignment techniques. Additionally, there is evidence of positive associations with lung cancer incidence and mortality in analyses limited to never smokers. The epidemiologic evidence is supported by both experimental and epidemiologic evidence of genotoxicity, epigenetic effects, carcinogenic potential, and that PM<sub>2.5</sub> exhibits several characteristics of carcinogens, which collectively provides biological plausibility for cancer development and resulted in the conclusion of a “likely to be causal relationship.”

For the additional health effects categories evaluated for PM<sub>2.5</sub> in the 2019 PM ISA, experimental and epidemiologic studies provide limited and/or inconsistent evidence of a relationship with PM<sub>2.5</sub> exposure. As a result, the 2019 PM ISA concluded that the evidence is “suggestive of, but not sufficient to infer a causal relationship” for short-term PM<sub>2.5</sub> exposure and metabolic effects and nervous system effects and for long-term PM<sub>2.5</sub> exposures and metabolic effects as well as reproductive and developmental effects.

In addition to evaluating the health effects attributed to short- and long-term exposure to PM<sub>2.5</sub>, the 2019 PM ISA also conducted an extensive evaluation as to whether specific components or sources of PM<sub>2.5</sub> are more strongly related with health effects than PM<sub>2.5</sub> mass. An evaluation of those studies resulted in the 2019 PM ISA concluding that “many PM<sub>2.5</sub> components and sources are associated with many health effects, and the evidence does not indicate that any one source or component is consistently more strongly related to health effects than PM<sub>2.5</sub> mass.”<sup>1024</sup>

For both PM<sub>10-2.5</sub> and UFPs, for all health effects categories evaluated, the 2019 PM ISA concluded that the evidence was “suggestive of, but not sufficient to infer, a causal relationship” or “inadequate to determine the presence or absence of a causal relationship.” For PM<sub>10-2.5</sub>, although a Federal Reference Method was instituted in 2011 to measure PM<sub>10-2.5</sub> concentrations nationally, the causality determinations reflect that the same

uncertainty identified in the 2009 PM ISA with respect to the method used to estimate PM<sub>10-2.5</sub> concentrations in epidemiologic studies persists. Specifically, across epidemiologic studies, different approaches are used to estimate PM<sub>10-2.5</sub> concentrations (*e.g.*, direct measurement of PM<sub>10-2.5</sub>, difference between PM<sub>10</sub> and PM<sub>2.5</sub> concentrations), and it remains unclear how well correlated PM<sub>10-2.5</sub> concentrations are both spatially and temporally across the different methods used.

For UFPs, which have often been defined as particles less than 0.1 μm, the uncertainty in the evidence for the health effect categories evaluated across experimental and epidemiologic studies reflects the inconsistency in the exposure metric used (*i.e.*, particle number concentration, surface area concentration, mass concentration) as well as the size fractions examined. In epidemiologic studies the size fraction examined can vary depending on the monitor used and exposure metric, with some studies examining number count over the entire particle size range, while experimental studies that use a particle concentrator often examine particles up to 0.3 μm. Additionally, due to the lack of a monitoring network, there is limited information on the spatial and temporal variability of UFPs within the U.S., as well as population exposures to UFPs, which adds uncertainty to epidemiologic study results.

The 2019 PM ISA cites extensive evidence indicating that “both the general population as well as specific populations and life stages are at risk for PM<sub>2.5</sub>-related health effects.”<sup>1025</sup> For example, in support of its “causal” and “likely to be causal” determinations, the ISA cites substantial evidence for (1) PM-related mortality and cardiovascular effects in older adults; (2) PM-related cardiovascular effects in people with pre-existing cardiovascular disease; (3) PM-related respiratory effects in people with pre-existing respiratory disease, particularly asthma exacerbations in children; and (4) PM-related impairments in lung function growth and asthma development in children. The ISA additionally notes that stratified analyses (*i.e.*, analyses that directly compare PM-related health effects across groups) provide strong evidence for racial and ethnic differences in PM<sub>2.5</sub> exposures and in the risk of PM<sub>2.5</sub>-related health effects, specifically within Hispanic and non-

<sup>1024</sup> U.S. EPA. Integrated Science Assessment (ISA) for Particulate Matter (Final Report, 2019). U.S. Environmental Protection Agency, Washington, DC, EPA/600/R-19/188, 2019.

<sup>1025</sup> U.S. EPA. Integrated Science Assessment (ISA) for Particulate Matter (Final Report, 2019). U.S. Environmental Protection Agency, Washington, DC, EPA/600/R-19/188, 2019.

Hispanic Black populations, with some evidence of increased risk for populations of low socioeconomic status. Recent studies evaluated in the Supplement support the conclusion of the 2019 PM ISA with respect to disparities in both PM<sub>2.5</sub> exposure and health risk by race and ethnicity and provide additional support for disparities for populations of lower socioeconomic status.<sup>1026</sup> Additionally, evidence spanning epidemiologic studies that conducted stratified analyses, experimental studies focusing on animal models of disease or individuals with pre-existing disease, dosimetry studies, as well as studies focusing on differential exposure suggest that populations with pre-existing cardiovascular or respiratory disease, populations that are overweight or obese, populations that have particular genetic variants, and current/former smokers could be at increased risk for adverse PM<sub>2.5</sub>-related health effects. The 2022 Policy Assessment for the review of the PM NAAQS also highlights that factors that may contribute to increased risk of PM<sub>2.5</sub>-related health effects include life stage (children and older adults), pre-existing diseases (cardiovascular disease and respiratory disease), race/ethnicity, and socioeconomic status.<sup>1027</sup>

ii. Ozone

This section provides a summary of the health effects associated with exposure to ambient concentrations of ozone.<sup>1028</sup> The information in this section is based on the information and conclusions in the April 2020 Integrated Science Assessment for Ozone (Ozone ISA).<sup>1029</sup> The Ozone ISA concludes that human exposures to ambient concentrations of ozone are associated with a number of adverse health effects and characterizes the weight of evidence

for these health effects.<sup>1030</sup> The discussion in this section VI.B.2.ii highlights the Ozone ISA's conclusions pertaining to health effects associated with both short-term and long-term periods of exposure to ozone.

For short-term exposure to ozone, the Ozone ISA concludes that respiratory effects, including lung function decrements, pulmonary inflammation, exacerbation of asthma, respiratory-related hospital admissions, and mortality, are causally associated with ozone exposure. It also concludes that metabolic effects, including metabolic syndrome (*i.e.*, changes in insulin or glucose levels, cholesterol levels, obesity, and blood pressure) and complications due to diabetes are likely to be causally associated with short-term exposure to ozone and that evidence is suggestive of a causal relationship between cardiovascular effects, central nervous system effects and total mortality and short-term exposure to ozone.

For long-term exposure to ozone, the Ozone ISA concludes that respiratory effects, including new onset asthma, pulmonary inflammation, and injury, are likely to be causally related with ozone exposure. The Ozone ISA characterizes the evidence as suggestive of a causal relationship for associations between long-term ozone exposure and cardiovascular effects, metabolic effects, reproductive and developmental effects, central nervous system effects and total mortality. The evidence is inadequate to infer a causal relationship between chronic ozone exposure and increased risk of cancer.

Finally, interindividual variation in human responses to ozone exposure can result in some groups being at increased risk for detrimental effects in response to exposure. In addition, some groups are at increased risk of exposure due to their activities, such as outdoor workers and children. The Ozone ISA identified several groups that are at increased risk for ozone-related health effects. These groups are people with asthma, children and older adults, individuals with reduced intake of certain nutrients (*i.e.*, Vitamins C and E), outdoor workers, and individuals having certain genetic variants related to oxidative metabolism or inflammation. Ozone exposure

during childhood can have lasting effects through adulthood. Such effects include altered function of the respiratory and immune systems. Children absorb higher doses (normalized to lung surface area) of ambient ozone, compared to adults, due to their increased time spent outdoors, higher ventilation rates relative to body size, and a tendency to breathe a greater fraction of air through the mouth.<sup>1031</sup> Children also have a higher asthma prevalence compared to adults. Recent epidemiologic studies provide generally consistent evidence that long-term ozone exposure is associated with the development of asthma in children. Studies comparing age groups reported higher magnitude associations for short-term ozone exposure and respiratory hospital admissions and emergency room visits among children than among adults. Panel studies also provide support for experimental studies with consistent associations between short-term ozone exposure and lung function and pulmonary inflammation in healthy children. Additional children's vulnerability and susceptibility factors are listed in section XI.B.2 of the preamble.

iii.

The most recent review of the health effects of oxides of nitrogen completed by EPA can be found in the 2016 Integrated Science Assessment for Oxides of Nitrogen—Health Criteria (Oxides of Nitrogen ISA).<sup>1032</sup> The primary source of NO<sub>2</sub> is motor vehicle emissions, and ambient NO<sub>2</sub> concentrations tend to be highly correlated with other traffic-related pollutants. Thus, a key issue in characterizing the causality of NO<sub>2</sub>-health effect relationships was evaluating the extent to which studies supported an effect of NO<sub>2</sub> that is independent of other traffic-related pollutants. EPA concluded that the findings for asthma exacerbation integrated from epidemiologic and

<sup>1026</sup> U.S. EPA. Supplement to the 2019 Integrated Science Assessment for Particulate Matter (Final Report, 2022). U.S. Environmental Protection Agency, Washington, DC, EPA/635/R-22/028, 2022.

<sup>1027</sup> U.S. EPA. Policy Assessment (PA) for the Reconsideration of the National Ambient Air Quality Standards for Particulate Matter (Final Report, 2022). U.S. Environmental Protection Agency, Washington, DC, EPA-452/R-22-004, 2022, p. 3-53.

<sup>1028</sup> Human exposure to ozone varies over time due to changes in ambient ozone concentration and because people move between locations which have notably different ozone concentrations. Also, the amount of ozone delivered to the lung is influenced not only by the ambient concentrations but also by the breathing route and rate.

<sup>1029</sup> U.S. EPA. Integrated Science Assessment (ISA) for Ozone and Related Photochemical Oxidants (Final Report). U.S. Environmental Protection Agency, Washington, DC, EPA/600/R-20/012, 2020.

<sup>1030</sup> The ISA evaluates evidence and draws conclusions on the causal relationship between relevant pollutant exposures and health effects, assigning one of five "weight of evidence" determinations: causal relationship, likely to be a causal relationship, suggestive of a causal relationship, inadequate to infer a causal relationship, and not likely to be a causal relationship. For more information on these levels of evidence, please refer to Table II in the Preamble of the ISA.

<sup>1031</sup> Children are more susceptible than adults to many air pollutants because of differences in physiology, higher per body weight breathing rates and consumption, rapid development of the brain and bodily systems, and behaviors that increase chances for exposure. Even before birth, the developing fetus may be exposed to air pollutants through the mother that affect development and permanently harm the individual. Infants and children breathe at much higher rates per body weight than adults, with infants under one year of age having a breathing rate up to five times that of adults. In addition, children breathe through their mouths more than adults and their nasal passages are less effective at removing pollutants, which leads to a higher deposition fraction in their lungs.

<sup>1032</sup> U.S. EPA. Integrated Science Assessment for Oxides of Nitrogen—Health Criteria (2016 Final Report). U.S. Environmental Protection Agency, Washington, DC, EPA/600/R-15/068, 2016.

controlled human exposure studies provided evidence that is sufficient to infer a causal relationship between respiratory effects and short-term NO<sub>2</sub> exposure. The strongest evidence supporting an independent effect of NO<sub>2</sub> exposure comes from controlled human exposure studies demonstrating increased airway responsiveness in individuals with asthma following ambient-relevant NO<sub>2</sub> exposures. The coherence of this evidence with epidemiologic findings for asthma hospital admissions and emergency department visits as well as lung function decrements and increased pulmonary inflammation in children with asthma describe a plausible pathway by which NO<sub>2</sub> exposure can cause an asthma exacerbation. The 2016 ISA for Oxides of Nitrogen also concluded that there is likely to be a causal relationship between long-term NO<sub>2</sub> exposure and respiratory effects. This conclusion is based on new epidemiologic evidence for associations of NO<sub>2</sub> with asthma development in children combined with biological plausibility from experimental studies.

In evaluating a broader range of health effects, the 2016 ISA for Oxides of Nitrogen concluded that evidence is “suggestive of, but not sufficient to infer, a causal relationship” between short-term NO<sub>2</sub> exposure and cardiovascular effects and mortality and between long-term NO<sub>2</sub> exposure and cardiovascular effects and diabetes, birth outcomes, and cancer. In addition, the scientific evidence is inadequate (insufficient consistency of epidemiologic and toxicological evidence) to infer a causal relationship for long-term NO<sub>2</sub> exposure with fertility, reproduction, and pregnancy, as well as with postnatal development. A key uncertainty in understanding the relationship between these non-respiratory health effects and short- or long-term exposure to NO<sub>2</sub> is co-pollutant confounding, particularly by other roadway pollutants. The available evidence for non-respiratory health effects does not adequately address whether NO<sub>2</sub> has an independent effect or whether it primarily represents effects related to other or a mixture of traffic-related pollutants.

The 2016 ISA for Oxides of Nitrogen concluded that people with asthma, children, and older adults are at increased risk for NO<sub>2</sub>-related health effects. In these groups and lifestages, NO<sub>2</sub> is consistently related to larger effects on outcomes related to asthma exacerbation, for which there is confidence in the relationship with NO<sub>2</sub> exposure.

#### iv. Sulfur Oxides

This section provides an overview of the health effects associated with SO<sub>2</sub>. Additional information on the health effects of SO<sub>2</sub> can be found in the 2017 Integrated Science Assessment for Sulfur Oxides—Health Criteria (SO<sub>x</sub> ISA).<sup>1033</sup> Following an extensive evaluation of health evidence from animal toxicological, controlled human exposure, and epidemiologic studies, the EPA has concluded that there is a causal relationship between respiratory health effects and short-term exposure to SO<sub>2</sub>. The immediate effect of SO<sub>2</sub> on the respiratory system in humans is bronchoconstriction. People with asthma are more sensitive to the effects of SO<sub>2</sub>, likely resulting from preexisting inflammation associated with this disease. In addition to those with asthma (both children and adults), there is suggestive evidence that all children and older adults may be at increased risk of SO<sub>2</sub>-related health effects. In free-breathing laboratory studies involving controlled human exposures to SO<sub>2</sub>, respiratory effects have consistently been observed following 5–10 min exposures at SO<sub>2</sub> concentrations ≥400 ppb in people with asthma engaged in moderate to heavy levels of exercise, with respiratory effects occurring at concentrations as low as 200 ppb in some individuals with asthma. A clear concentration-response relationship has been demonstrated in these studies following exposures to SO<sub>2</sub> at concentrations between 200 and 1000 ppb, both in terms of increasing severity of respiratory symptoms and decrements in lung function, as well as the percentage of individuals with asthma adversely affected. Epidemiologic studies have reported positive associations between short-term ambient SO<sub>2</sub> concentrations and hospital admissions and emergency department visits for asthma and for all respiratory causes, particularly among children and older adults (≥65 years). The studies provide supportive evidence for the causal relationship.

For long-term SO<sub>2</sub> exposure and respiratory effects, the EPA has concluded that the evidence is suggestive of a causal relationship. This conclusion is based on new epidemiologic evidence for positive associations between long-term SO<sub>2</sub> exposure and increases in asthma incidence among children, together with animal toxicological evidence that provides a pathophysiologic basis for

<sup>1033</sup> U.S. EPA. Integrated Science Assessment (ISA) for Sulfur Oxides—Health Criteria (Final Report, Dec 2017). U.S. Environmental Protection Agency, Washington, DC, EPA/600/R-17/451, 2017.

the development of asthma. However, uncertainty remains regarding the influence of other pollutants on the observed associations with SO<sub>2</sub> because these epidemiologic studies have not examined the potential for co-pollutant confounding.

Consistent associations between short-term exposure to SO<sub>2</sub> and mortality have been observed in epidemiologic studies with larger effect estimates reported for respiratory mortality than for cardiovascular mortality. While this finding is consistent with the demonstrated effects of SO<sub>2</sub> on respiratory morbidity, uncertainty remains with respect to the interpretation of these observed mortality associations due to potential confounding by various copollutants. Therefore, the EPA has concluded that the overall evidence is suggestive of a causal relationship between short-term exposure to SO<sub>2</sub> and mortality.

#### v. Carbon Monoxide

Information on the health effects of carbon monoxide (CO) can be found in the January 2010 Integrated Science Assessment for Carbon Monoxide (CO ISA).<sup>1034</sup> The CO ISA presents conclusions regarding the presence of causal relationships between CO exposure and categories of adverse health effects.<sup>1035</sup> This section provides a summary of the health effects associated with exposure to ambient concentrations of CO, along with the CO ISA conclusions.<sup>1036</sup>

Controlled human exposure studies of subjects with coronary artery disease show a decrease in the time to onset of exercise-induced angina (chest pain) and electrocardiogram changes following CO exposure. In addition, epidemiologic studies presented in the CO ISA observed associations between short-term CO exposure and cardiovascular morbidity, particularly increased emergency room visits and hospital admissions for coronary heart disease (including ischemic heart

<sup>1034</sup> U.S. EPA (2010). Integrated Science Assessment for Carbon Monoxide (Final Report). U.S. Environmental Protection Agency, Washington, DC, EPA/600/R-09/019F, 2010.

<sup>1035</sup> The ISA evaluates the health evidence associated with different health effects, assigning one of five “weight of evidence” determinations: causal relationship, likely to be a causal relationship, suggestive of a causal relationship, inadequate to infer a causal relationship, and not likely to be a causal relationship. For definitions of these levels of evidence, please refer to section 1.6 of the ISA.

<sup>1036</sup> Personal exposure includes contributions from many sources, and in many different environments. Total personal exposure to CO includes both ambient and non-ambient components; and both components may contribute to adverse health effects.

disease, myocardial infarction, and angina). Some epidemiologic evidence is also available for increased hospital admissions and emergency room visits for congestive heart failure and cardiovascular diseases as a whole. The CO ISA concludes that a causal relationship is likely to exist between short-term exposures to CO and cardiovascular morbidity. It also concludes that available data are inadequate to conclude that a causal relationship exists between long-term exposures to CO and cardiovascular morbidity.

Animal studies show various neurological effects with in-utero CO exposure. Controlled human exposure studies report central nervous system and behavioral effects following low-level CO exposures, although the findings have not been consistent across all studies. The CO ISA concludes that the evidence is suggestive of a causal relationship with both short- and long-term exposure to CO and central nervous system effects.

A number of studies cited in the CO ISA have evaluated the role of CO exposure in birth outcomes such as preterm birth or cardiac birth defects. There is limited epidemiologic evidence of a CO-induced effect on preterm births and birth defects, with weak evidence for a decrease in birth weight. Animal toxicological studies have found perinatal CO exposure to affect birth weight, as well as other developmental outcomes. The CO ISA concludes that the evidence is suggestive of a causal relationship between long-term exposures to CO and developmental effects and birth outcomes.

Epidemiologic studies provide evidence of associations between short-term CO concentrations and respiratory morbidity such as changes in pulmonary function, respiratory symptoms, and hospital admissions. A limited number of epidemiologic studies considered copollutants such as ozone, SO<sub>2</sub>, and PM in two-pollutant models and found that CO risk estimates were generally robust, although this limited evidence makes it difficult to disentangle effects attributed to CO itself from those of the larger complex air pollution mixture. Controlled human exposure studies have not extensively evaluated the effect of CO on respiratory morbidity. Animal studies at levels of 50–100 ppm CO show preliminary evidence of altered pulmonary vascular remodeling and oxidative injury. The CO ISA concludes that the evidence is suggestive of a causal relationship between short-term CO exposure and respiratory morbidity, and inadequate to conclude that a causal relationship

exists between long-term exposure and respiratory morbidity.

Finally, the CO ISA concludes that the epidemiologic evidence is suggestive of a causal relationship between short-term concentrations of CO and mortality. Epidemiologic evidence suggests an association exists between short-term exposure to CO and mortality, but limited evidence is available to evaluate cause-specific mortality outcomes associated with CO exposure. In addition, the attenuation of CO risk estimates which was often observed in co-pollutant models contributes to the uncertainty as to whether CO is acting alone or as an indicator for other combustion-related pollutants. The CO ISA also concludes that there is not likely to be a causal relationship between relevant long-term exposures to CO and mortality.

#### vi. Diesel Exhaust

In EPA's 2002 Diesel Health Assessment Document (Diesel HAD), exposure to diesel exhaust was classified as likely to be carcinogenic to humans by inhalation from environmental exposures, in accordance with the revised draft 1996/1999 EPA cancer guidelines.<sup>1037 1038</sup> A number of other agencies (National Institute for Occupational Safety and Health, the International Agency for Research on Cancer, the World Health Organization, California EPA, and the U.S. Department of Health and Human Services) made similar hazard classifications prior to 2002. EPA also concluded in the 2002 Diesel HAD that it was not possible to calculate a cancer unit risk for diesel exhaust due to limitations in the exposure data for the occupational groups or the absence of a dose-response relationship.

In the absence of a cancer unit risk, the Diesel HAD sought to provide additional insight into the significance of the diesel exhaust cancer hazard by estimating possible ranges of risk that might be present in the population. An exploratory analysis was used to characterize a range of possible lung cancer risk. The outcome was that environmental risks of cancer from long-term diesel exhaust exposures could plausibly range from as low as 10<sup>-5</sup> to as high as 10<sup>-3</sup>. Because of

<sup>1037</sup> U.S. EPA. (1999). Guidelines for Carcinogen Risk Assessment. Review Draft. NCEA-F-0644, July. Washington, DC: U.S. EPA. Retrieved on March 19, 2009 from <http://cfpub.epa.gov/ncea/cfm/recordisplay.cfm?deid=54932>.

<sup>1038</sup> U.S. EPA (2002). Health Assessment Document for Diesel Engine Exhaust. EPA/600/8-90/057F Office of research and Development, Washington DC. Retrieved on March 17, 2009, from <http://cfpub.epa.gov/ncea/cfm/recordisplay.cfm?deid=29060>. pp. 1-1 1-2.

uncertainties, the analysis acknowledged that the risks could be lower than 10<sup>-5</sup>, and a zero risk from diesel exhaust exposure could not be ruled out.

Noncancer health effects of acute and chronic exposure to diesel exhaust emissions are also of concern to EPA. EPA derived a diesel exhaust reference concentration (RfC) from consideration of four well-conducted chronic rat inhalation studies showing adverse pulmonary effects. The RfC is 5 µg/m<sup>3</sup> for diesel exhaust measured as diesel particulate matter. This RfC does not consider allergenic effects such as those associated with asthma or immunologic or the potential for cardiac effects. There was emerging evidence in 2002, discussed in the Diesel HAD, that exposure to diesel exhaust can exacerbate these effects, but the exposure-response data were lacking at that time to derive an RfC based on these then-emerging considerations. The Diesel HAD states, "With [diesel particulate matter] being a ubiquitous component of ambient PM, there is an uncertainty about the adequacy of the existing [diesel exhaust] noncancer database to identify all of the pertinent [diesel exhaust]-caused noncancer health hazards." The Diesel HAD also notes "that acute exposure to [diesel exhaust] has been associated with irritation of the eye, nose, and throat, respiratory symptoms (cough and phlegm), and neurophysiological symptoms such as headache, lightheadedness, nausea, vomiting, and numbness or tingling of the extremities." The Diesel HAD notes that the cancer and noncancer hazard conclusions applied to the general use of diesel engines then on the market and as cleaner engines replace a substantial number of existing ones, the applicability of the conclusions would need to be reevaluated.

It is important to note that the Diesel HAD also briefly summarizes health effects associated with ambient PM and discusses EPA's then-annual PM<sub>2.5</sub> NAAQS of 15 µg/m<sup>3</sup>. In 2012, EPA revised the level of the annual PM<sub>2.5</sub> NAAQS to 12 µg/m<sup>3</sup> and in 2024 EPA revised the level of the annual PM<sub>2.5</sub> NAAQS to 9.0 µg/m<sup>3</sup>.<sup>1039</sup> There is a large and extensive body of human data showing a wide spectrum of adverse health effects associated with exposure to ambient PM, of which diesel exhaust is an important component. The PM<sub>2.5</sub> NAAQS provides protection from the health effects attributed to exposure to PM<sub>2.5</sub>. The contribution of diesel PM to

<sup>1039</sup> <https://www.epa.gov/pm-pollution/national-ambient-air-quality-standards-naaqs-pm>.

total ambient PM varies in different regions of the country and also within a region from one area to another. The contribution can be high in near-roadway environments, for example, or in other locations where diesel engine use is concentrated.

Since 2002, several new studies have been published which continue to report increased lung cancer risk associated with occupational exposure to diesel exhaust from older engines. Of particular note since 2011 are three new epidemiology studies which have examined lung cancer in occupational populations, including truck drivers, underground nonmetal miners, and other diesel motor-related occupations. These studies reported increased risk of lung cancer related to exposure to diesel exhaust, with evidence of positive exposure-response relationships to varying degrees.<sup>1040 1041 1042</sup> These newer studies (along with others that have appeared in the scientific literature) add to the evidence EPA evaluated in the 2002 Diesel HAD and further reinforce the concern that diesel exhaust exposure likely poses a lung cancer hazard. The findings from these newer studies do not necessarily apply to newer technology diesel engines (*i.e.*, heavy-duty highway engines from 2007 and later model years) since the newer engines have large reductions in the emission constituents compared to older technology diesel engines.

In light of the growing body of scientific literature evaluating the health effects of exposure to diesel exhaust, in June 2012 the World Health Organization's International Agency for Research on Cancer (IARC), a recognized international authority on the carcinogenic potential of chemicals and other agents, evaluated the full range of cancer-related health effects data for diesel engine exhaust. IARC concluded that diesel exhaust should be regarded as "carcinogenic to humans."<sup>1043</sup> This designation was an

<sup>1040</sup> Garshick, Eric, Francine Laden, Jaime E. Hart, Mary E. Davis, Ellen A. Eisen, and Thomas J. Smith. 2012. Lung cancer and elemental carbon exposure in trucking industry workers. *Environmental Health Perspectives* 120(9): 1301–1306.

<sup>1041</sup> Silverman, D.T., Samanic, C.M., Lubin, J.H., Blair, A.E., Stewart, P.A., Vermeulen, R., & Attfield, M.D. (2012). The diesel exhaust in miners study: a nested case-control study of lung cancer and diesel exhaust. *Journal of the National Cancer Institute*.

<sup>1042</sup> Olsson, Ann C., et al. "Exposure to diesel motor exhaust and lung cancer risk in a pooled analysis from case-control studies in Europe and Canada." *American journal of respiratory and critical care medicine* 183.7 (2011): 941–948.

<sup>1043</sup> IARC [International Agency for Research on Cancer]. (2013). Diesel and gasoline engine exhausts and some nitroarenes. IARC Monographs Volume 105. Online at <http://monographs.iarc.fr/ENG/Monographs/vol105/index.php>.

update from its 1988 evaluation that considered the evidence to be indicative of a "probable human carcinogen."

vii. Air Toxics

Heavy-duty engine emissions contribute to ambient levels of air toxics that are known or suspected human or animal carcinogens or that have noncancer health effects. These compounds include, but are not limited to, acetaldehyde, benzene, 1,3-butadiene, formaldehyde, and naphthalene. These compounds were all identified as national cancer risk drivers or contributors in the 2019 Air Toxics Screening Assessment (AirToxScreen).<sup>1044 1045</sup>

a. Acetaldehyde

Acetaldehyde is classified in EPA's IRIS database as a probable human carcinogen, based on nasal tumors in rats, and is considered toxic by the inhalation, oral, and intravenous routes.<sup>1046</sup> The inhalation unit risk estimate (URE) in IRIS for acetaldehyde is  $2.2 \times 10^{-6}$  per  $\mu\text{g}/\text{m}^3$ .<sup>1047</sup>

Acetaldehyde is reasonably anticipated to be a human carcinogen by the NTP in the 14th Report on Carcinogens and is classified as possibly carcinogenic to humans (Group 2B) by the IARC.<sup>1048 1049</sup> The primary noncancer effects of exposure to acetaldehyde vapors include irritation of the eyes, skin, and respiratory tract.<sup>1050</sup> In short-term (4 week) rat studies, degeneration of olfactory epithelium was observed at

<sup>1044</sup> U.S. EPA (2022) Technical Support Document EPA's Air Toxics Screening Assessment. 2018 AirToxScreen TSD. [https://www.epa.gov/system/files/documents/2023-02/AirToxScreen\\_2018%20TSD.pdf](https://www.epa.gov/system/files/documents/2023-02/AirToxScreen_2018%20TSD.pdf).

<sup>1045</sup> U.S. EPA (2023) 2019 AirToxScreen Risk Drivers. <https://www.epa.gov/AirToxScreen/airtoxscreen-risk-drivers>.

<sup>1046</sup> U.S. EPA (1991). Integrated Risk Information System File of Acetaldehyde. Research and Development, National Center for Environmental Assessment, Washington, DC. This material is available electronically at [https://cfpub.epa.gov/ncea/iris2/chemicalLanding.cfm?substance\\_nmbr=290](https://cfpub.epa.gov/ncea/iris2/chemicalLanding.cfm?substance_nmbr=290).

<sup>1047</sup> U.S. EPA (1991). Integrated Risk Information System File of Acetaldehyde. This material is available electronically at [https://cfpub.epa.gov/ncea/iris2/chemicalLanding.cfm?substance\\_nmbr=290](https://cfpub.epa.gov/ncea/iris2/chemicalLanding.cfm?substance_nmbr=290).

<sup>1048</sup> NTP (National Toxicology Program). 2016. Report on Carcinogens, Fourteenth Edition.; Research Triangle Park, NC: U.S. Department of Health and Human Services, Public Health Service. <https://ntp.niehs.nih.gov/go/roc14>.

<sup>1049</sup> International Agency for Research on Cancer (IARC). (1999). Re-evaluation of some organic chemicals, hydrazine, and hydrogen peroxide. IARC Monographs on the Evaluation of Carcinogenic Risk of Chemical to Humans, Vol 71. Lyon, France.

<sup>1050</sup> U.S. EPA (1991). Integrated Risk Information System File of Acetaldehyde. This material is available electronically at [https://cfpub.epa.gov/ncea/iris2/chemicalLanding.cfm?substance\\_nmbr=290](https://cfpub.epa.gov/ncea/iris2/chemicalLanding.cfm?substance_nmbr=290).

various concentration levels of acetaldehyde exposure.<sup>1051</sup> Data from these studies were used by EPA to develop an inhalation reference concentration of  $9 \mu\text{g}/\text{m}^3$ . Some asthmatics have been shown to be a sensitive subpopulation to decrements in functional expiratory volume (FEV1 test) and bronchoconstriction upon acetaldehyde inhalation.<sup>1052</sup> Children, especially those with diagnosed asthma, may be more likely to show impaired pulmonary function and symptoms of asthma than are adults following exposure to acetaldehyde.<sup>1053</sup>

b. Benzene

EPA's Integrated Risk Information System (IRIS) database lists benzene as a known human carcinogen (causing leukemia) by all routes of exposure and concludes that exposure is associated with additional health effects, including genetic changes in both humans and animals and increased proliferation of bone marrow cells in mice.<sup>1054 1055 1056</sup> EPA states in its IRIS database that data indicate a causal relationship between benzene exposure and acute lymphocytic leukemia and suggest a relationship between benzene exposure and chronic non-lymphocytic leukemia and chronic lymphocytic leukemia. EPA's IRIS documentation for benzene also lists a range of  $2.2 \times 10^{-6}$  to  $7.8 \times 10^{-6}$  per  $\mu\text{g}/\text{m}^3$  as the unit risk estimate (URE) for benzene.<sup>1057 1058</sup> The

<sup>1051</sup> Appleman, L.M., R.A. Woutersen, and V.J. Feron. (1982). Inhalation toxicity of acetaldehyde in rats. I. Acute and subacute studies. *Toxicology*. 23: 293–297.

<sup>1052</sup> Myou, S.; Fujimura, M.; Nishi K.; Ohka, T.; and Matsuda, T. (1993). Aerosolized acetaldehyde induces histamine-mediated bronchoconstriction in asthmatics. *Am. Rev. Respir. Dis.* 148(4 Pt 1): 940–943.

<sup>1053</sup> California OEHHA, 2014. TSD for Noncancer RELs: Appendix D. Individual, Acute, 8-Hour, and Chronic Reference Exposure Level Summaries. December 2008 (updated July 2014). <https://oehha.ca.gov/media/downloads/cnr/appendixd1final.pdf>.

<sup>1054</sup> U.S. EPA. (2000). Integrated Risk Information System File for Benzene. This material is available electronically at: [https://cfpub.epa.gov/ncea/iris2/chemicalLanding.cfm?substance\\_nmbr=276](https://cfpub.epa.gov/ncea/iris2/chemicalLanding.cfm?substance_nmbr=276).

<sup>1055</sup> International Agency for Research on Cancer. (1982). IARC monographs on the evaluation of carcinogenic risk of chemicals to humans, Volume 29, Some industrial chemicals and dyestuffs, International Agency for Research on Cancer, World Health Organization, Lyon, France 1982.

<sup>1056</sup> Irons, R.D.; Stillman, W.S.; Colagiovanni, D.B.; Henry, V.A. (1992). Synergistic action of the benzene metabolite hydroquinone on myelopoietic stimulating activity of granulocyte/macrophage colony-stimulating factor in vitro. *Proc. Natl. Acad. Sci.* 89:3691–3695.

<sup>1057</sup> A unit risk estimate is defined as the increase in the lifetime risk of cancer of an individual who is exposed for a lifetime to  $1 \mu\text{g}/\text{m}^3$  benzene in air.

<sup>1058</sup> U.S. EPA. (2000). Integrated Risk Information System File for Benzene. This material is available

Continued

International Agency for Research on Cancer (IARC) has determined that benzene is a human carcinogen, and the U.S. Department of Health and Human Services (DHHS) has characterized benzene as a known human carcinogen.<sup>1059 1060</sup>

A number of adverse noncancer health effects, including blood disorders such as preleukemia and aplastic anemia, have also been associated with long-term exposure to benzene.<sup>1061 1062</sup> The most sensitive noncancer effect observed in humans, based on current data, is the depression of the absolute lymphocyte count in blood.<sup>1063 1064</sup> EPA's inhalation reference concentration (RfC) for benzene is 30  $\mu\text{g}/\text{m}^3$ . The RfC is based on suppressed absolute lymphocyte counts seen in humans under occupational exposure conditions. In addition, studies sponsored by the Health Effects Institute (HEI) provide evidence that biochemical responses occur at lower levels of benzene exposure than previously known.<sup>1065 1066 1067 1068</sup> EPA's IRIS

electronically at: [https://cfpub.epa.gov/ncea/iris2/chemicalLanding.cfm?substance\\_nmbr=276](https://cfpub.epa.gov/ncea/iris2/chemicalLanding.cfm?substance_nmbr=276).

<sup>1059</sup> International Agency for Research on Cancer (IARC, 2018. Monographs on the evaluation of carcinogenic risks to humans, volume 120. World Health Organization—Lyon, France. <http://publications.iarc.fr/Book-And-Report-Series/Iarc-Monographs-On-The-Identification-Of-Carcinogenic-Hazards-To-Humans/Benzene-2018>.

<sup>1060</sup> NTP (National Toxicology Program). 2016. Report on Carcinogens, Fourteenth Edition.; Research Triangle Park, NC: U.S. Department of Health and Human Services, Public Health Service. <https://ntp.niehs.nih.gov/go/roct14>.

<sup>1061</sup> Aksoy, M. (1989). Hematotoxicity and carcinogenicity of benzene. *Environ. Health Perspect.* 82: 193–197. EPA–HQ–OAR–2011–0135.

<sup>1062</sup> Goldstein, B.D. (1988). Benzene toxicity. *Occupational medicine. State of the Art Reviews.* 3: 541–554.

<sup>1063</sup> Rothman, N., G.L. Li, M. Dosemeci, W.E. Bechtold, G.E. Marti, Y.Z. Wang, M. Linet, L.Q. Xi, W. Lu, M.T. Smith, N. Titenko-Holland, L.P. Zhang, W. Blot, S.N. Yin, and R.B. Hayes. (1996). Hematototoxicity among Chinese workers heavily exposed to benzene. *Am. J. Ind. Med.* 29: 236–246.

<sup>1064</sup> U.S. EPA (2002). Toxicological Review of Benzene (Noncancer Effects). Environmental Protection Agency, Integrated Risk Information System (IRIS), Research and Development, National Center for Environmental Assessment, Washington DC. This material is available electronically at [https://cfpub.epa.gov/ncea/iris/iris\\_documents/documents/toxreviews/0276tr.pdf](https://cfpub.epa.gov/ncea/iris/iris_documents/documents/toxreviews/0276tr.pdf).

<sup>1065</sup> Qu, O.; Shore, R.; Li, G.; Jin, X.; Chen, C.L.; Cohen, B.; Melikian, A.; Eastmond, D.; Rappaport, S.; Li, H.; Rupa, D.; Suramaya, R.; Songnian, W.; Huifant, Y.; Meng, M.; Winnik, M.; Kwok, E.; Li, Y.; Mu, R.; Xu, B.; Zhang, X.; Li, K. (2003). HEI Report 115, Validation & Evaluation of Biomarkers in Workers Exposed to Benzene in China.

<sup>1066</sup> Qu, Q., R. Shore, G. Li, X. Jin, L.C. Chen, B. Cohen, et al. (2002). Hematological changes among Chinese workers with a broad range of benzene exposures. *Am. J. Industr. Med.* 42: 275–285.

<sup>1067</sup> Lan, Qing, Zhang, L., Li, G., Vermeulen, R., et al. (2004). Hematotoxically in Workers Exposed to Low Levels of Benzene. *Science* 306: 1774–1776.

<sup>1068</sup> Turtletaub, K.W. and Mani, C. (2003). Benzene metabolism in rodents at doses relevant to

program has not yet evaluated these new data. EPA does not currently have an acute reference concentration for benzene. The Agency for Toxic Substances and Disease Registry (ATSDR) Minimal Risk Level (MRL) for acute inhalation exposure to benzene is 29  $\mu\text{g}/\text{m}^3$  for 1–14 days exposure.<sup>1069 1070</sup>

There is limited information from two studies regarding an increased risk of adverse effects to children whose parents have been occupationally more exposed to benzene.<sup>1071 1072</sup> Data from animal studies have shown benzene exposures result in damage to the hematopoietic (blood cell formation) system during development.<sup>1073 1074 1075</sup> Also, key changes related to the development of childhood leukemia occur in the developing fetus.<sup>1076</sup> Several studies have reported that genetic changes related to eventual leukemia development occur before birth. For example, there is one study of genetic changes in twins who developed T cell leukemia at nine years of age.<sup>1077</sup>

#### c. 1,3-Butadiene

EPA has characterized 1,3-butadiene as carcinogenic to humans by

human exposure from Urban Air. Research Reports Health Effect Inst. Report No.113.

<sup>1069</sup> U.S. Agency for Toxic Substances and Disease Registry (ATSDR). (2007). Toxicological profile for benzene. Atlanta, GA: U.S. Department of Health and Human Services, Public Health Service. <http://www.atsdr.cdc.gov/ToxProfiles/tp3.pdf>.

<sup>1070</sup> A minimal risk level (MRL) is defined as an estimate of the daily human exposure to a hazardous substance that is likely to be without appreciable risk of adverse noncancer health effects over a specified duration of exposure.

<sup>1071</sup> Corti, M; Snyder, CA. (1996) Influences of gender, development, pregnancy and ethanol consumption on the hematotoxicity of inhaled 10 ppm benzene. *Arch Toxicol* 70:209–217.

<sup>1072</sup> McKinney P.A.; Alexander, F.E.; Cartwright, R.A.; et al. (1991) Parental occupations of children with leukemia in west Cumbria, north Humberside, and Gateshead, *Br Med J* 302:681–686.

<sup>1073</sup> Keller, KA; Snyder, CA. (1986) Mice exposed in utero to low concentrations of benzene exhibit enduring changes in their colony forming hematopoietic cells. *Toxicology* 42:171–181.

<sup>1074</sup> Keller, KA; Snyder, CA. (1988) Mice exposed in utero to 20 ppm benzene exhibit altered numbers of recognizable hematopoietic cells up to seven weeks after exposure. *Fundam Appl Toxicol* 10:224–232.

<sup>1075</sup> Corti, M; Snyder, CA. (1996) Influences of gender, development, pregnancy and ethanol consumption on the hematotoxicity of inhaled 10 ppm benzene. *Arch Toxicol* 70:209–217.

<sup>1076</sup> U. S. EPA. (2002). Toxicological Review of Benzene (Noncancer Effects). National Center for Environmental Assessment, Washington, DC. Report No. EPA/635/R-02/001F. [https://cfpub.epa.gov/ncea/iris/iris\\_documents/documents/toxreviews/0276tr.pdf](https://cfpub.epa.gov/ncea/iris/iris_documents/documents/toxreviews/0276tr.pdf).

<sup>1077</sup> Ford, AM; Pombo-de-Oliveira, MS; McCarthy, KP; MacLean, JM; Carrico, KC; Vincent, RF; Greaves, M. (1997) Monoclonal origin of concordant T-cell malignancy in identical twins. *Blood* 89:281–285.

inhalation.<sup>1078 1079</sup> The IARC has determined that 1,3-butadiene is a human carcinogen, and the U.S. DHHS has characterized 1,3-butadiene as a known human carcinogen.<sup>1080 1081 1082 1083</sup> There are numerous studies consistently demonstrating that 1,3-butadiene is metabolized into genotoxic metabolites by experimental animals and humans. The specific mechanisms of 1,3-butadiene-induced carcinogenesis are unknown; however, the scientific evidence strongly suggests that the carcinogenic effects are mediated by genotoxic metabolites. Animal data suggest that females may be more sensitive than males for cancer effects associated with 1,3-butadiene exposure; there are insufficient data in humans from which to draw conclusions about sensitive subpopulations. The URE for 1,3-butadiene is  $3 \times 10^{-5}$  per  $\mu\text{g}/\text{m}^3$ .<sup>1084</sup> 1,3-butadiene also causes a variety of reproductive and developmental effects in mice; no human data on these effects are available. The most sensitive effect was ovarian atrophy observed in a lifetime bioassay of female mice.<sup>1085</sup>

<sup>1078</sup> U.S. EPA. (2002). Health Assessment of 1,3-Butadiene. Office of Research and Development, National Center for Environmental Assessment, Washington Office, Washington, DC. Report No. EPA600–P–98–001F. This document is available electronically at [https://cfpub.epa.gov/ncea/iris\\_drafts/recorddisplay.cfm?deid=54499](https://cfpub.epa.gov/ncea/iris_drafts/recorddisplay.cfm?deid=54499).

<sup>1079</sup> U.S. EPA. (2002) “Full IRIS Summary for 1,3-butadiene (CASRN 106–99–0)” Environmental Protection Agency, Integrated Risk Information System (IRIS), Research and Development, National Center for Environmental Assessment, Washington, DC [https://cfpub.epa.gov/ncea/iris2/chemicalLanding.cfm?substance\\_nmbr=139](https://cfpub.epa.gov/ncea/iris2/chemicalLanding.cfm?substance_nmbr=139).

<sup>1080</sup> International Agency for Research on Cancer (IARC). (1999). Monographs on the evaluation of carcinogenic risk of chemicals to humans, Volume 71, Re-evaluation of some organic chemicals, hydrazine and hydrogen peroxide, World Health Organization, Lyon, France.

<sup>1081</sup> International Agency for Research on Cancer (IARC). (2008). Monographs on the evaluation of carcinogenic risk of chemicals to humans, 1,3-Butadiene, Ethylene Oxide and Vinyl Halides (Vinyl Fluoride, Vinyl Chloride and Vinyl Bromide) Volume 97, World Health Organization, Lyon, France.

<sup>1082</sup> NTP (National Toxicology Program). 2016. Report on Carcinogens, Fourteenth Edition.; Research Triangle Park, NC: U.S. Department of Health and Human Services, Public Health Service. <https://ntp.niehs.nih.gov/go/roct14>.

<sup>1083</sup> International Agency for Research on Cancer (IARC). (2012). Monographs on the evaluation of carcinogenic risk of chemicals to humans, Volume 100F chemical agents and related occupations, World Health Organization, Lyon, France.

<sup>1084</sup> U.S. EPA. (2002). “Full IRIS Summary for 1,3-butadiene (CASRN 106–99–0)” Environmental Protection Agency, Integrated Risk Information System (IRIS), Research and Development, National Center for Environmental Assessment, Washington, DC [https://cfpub.epa.gov/ncea/iris2/chemicalLanding.cfm?substance\\_nmbr=139](https://cfpub.epa.gov/ncea/iris2/chemicalLanding.cfm?substance_nmbr=139).

<sup>1085</sup> Bevan, C.; Stadler, J.C.; Elliot, G.S.; et al. (1996). Subchronic toxicity of 4-vinylcyclohexene in rats and mice by inhalation. *Fundam. Appl. Toxicol.* 32:1–10.



Based on this critical effect and the benchmark concentration methodology, an RFC for chronic health effects was calculated at 0.9 ppb (approximately 2 µg/m<sup>3</sup>).

d. Formaldehyde

In 1991, EPA concluded that formaldehyde is a Class B1 probable human carcinogen based on limited evidence in humans and sufficient evidence in animals.<sup>1086</sup> An inhalation URE for cancer and a reference dose for oral noncancer effects were developed by EPA and posted on the IRIS database. Since that time, the NTP and IARC have concluded that formaldehyde is a known human carcinogen.<sup>1087 1088 1089</sup>

The conclusions by IARC and NTP reflect the results of epidemiologic research published since 1991 in combination with previous and more recent animal, human and mechanistic evidence. Research conducted by the National Cancer Institute reported an increased risk of nasopharyngeal cancer and specific lymphohematopoietic malignancies among workers exposed to formaldehyde.<sup>1090 1091 1092</sup> A National Institute of Occupational Safety and Health study of garment workers also reported increased risk of death due to leukemia among workers exposed to formaldehyde.<sup>1093</sup> Extended follow-up of a cohort of British chemical workers did not report evidence of an increase in nasopharyngeal or lymphohematopoietic cancers, but a

continuing statistically significant excess in lung cancers was reported.<sup>1094</sup> Finally, a study of embalmers reported formaldehyde exposures to be associated with an increased risk of myeloid leukemia but not brain cancer.<sup>1095</sup>

Health effects of formaldehyde in addition to cancer were reviewed by the Agency for Toxic Substances and Disease Registry in 1999, supplemented in 2010, and by the World Health Organization.<sup>1096 1097 1098</sup> These organizations reviewed the scientific literature concerning health effects linked to formaldehyde exposure to evaluate hazards and dose response relationships and defined exposure concentrations for minimal risk levels (MRLs). The health endpoints reviewed included sensory irritation of eyes and respiratory tract, reduced pulmonary function, nasal histopathology, and immune system effects. In addition, research on reproductive and developmental effects and neurological effects was discussed along with several studies that suggest that formaldehyde may increase the risk of asthma—particularly in the young.

In June 2010, EPA released a draft Toxicological Review of Formaldehyde—Inhalation Assessment through the IRIS program for peer review by the National Research Council (NRC) and public comment.<sup>1099</sup> That draft assessment reviewed more recent research from animal and human studies on cancer and other health effects. The NRC released their review report in April 2011.<sup>1100</sup> EPA addressed

the NRC (2011) recommendations and applied systematic review methods to the evaluation of the available noncancer and cancer health effects evidence and released a new draft IRIS Toxicological Review of Formaldehyde—Inhalation in April 2022.<sup>1101</sup> In this draft, updates to the 1991 IRIS finding include a stronger determination of the carcinogenicity of formaldehyde inhalation to humans, as well as characterization of its noncancer effects to propose an overall reference concentration for inhalation exposure. The National Academies of Sciences, Engineering, and Medicine released their review of EPA’s 2022 Draft Formaldehyde Assessment in August 2023, concluding that EPA’s “findings on formaldehyde hazard and quantitative risk are supported by the evidence identified.”<sup>1102</sup> EPA is currently revising the draft IRIS assessment in response to comments received.<sup>1103</sup>

e. Naphthalene

Naphthalene is found in small quantities in gasoline and diesel fuels. Naphthalene emissions have been measured in larger quantities in both gasoline and diesel exhaust compared with evaporative emissions from mobile sources, indicating it is primarily a product of combustion.

Acute (short-term) exposure of humans to naphthalene by inhalation, ingestion, or dermal contact is associated with hemolytic anemia and damage to the liver and the nervous system.<sup>1104</sup> Chronic (long term) exposure of workers and rodents to naphthalene has been reported to cause cataracts and retinal damage.<sup>1105</sup>

Draft IRIS Assessment of Formaldehyde. Washington DC: National Academies Press. [http://books.nap.edu/openbook.php?record\\_id=13142](http://books.nap.edu/openbook.php?record_id=13142).

<sup>1101</sup> U.S. EPA. 2022. IRIS Toxicological Review of Formaldehyde-Inhalation (External Review Draft, 2022). U.S. Environmental Protection Agency, Washington, DC, EPA/635/R-22/039.

<sup>1102</sup> National Academies of Sciences, Engineering, and Medicine. 2023. Review of EPA’s 2022 Draft Formaldehyde Assessment. Washington, DC: The National Academies Press. <https://doi.org/10.17226/27153>.

<sup>1103</sup> For more information, see [https://cfpub.epa.gov/ncea/iris\\_drafts/recordisplay.cfm?deid=248150#](https://cfpub.epa.gov/ncea/iris_drafts/recordisplay.cfm?deid=248150#).

<sup>1104</sup> U.S. EPA. 1998. Toxicological Review of Naphthalene (Reassessment of the Inhalation Cancer Risk), Environmental Protection Agency, Integrated Risk Information System, Research and Development, National Center for Environmental Assessment, Washington, DC. This material is available electronically at [https://cfpub.epa.gov/ncea/iris\\_drafts/recordisplay.cfm?deid=56434](https://cfpub.epa.gov/ncea/iris_drafts/recordisplay.cfm?deid=56434).

<sup>1105</sup> U.S. EPA. 1998. Toxicological Review of Naphthalene (Reassessment of the Inhalation Cancer Risk), Environmental Protection Agency, Integrated Risk Information System, Research and Development, National Center for Environmental

<sup>1086</sup> EPA. Integrated Risk Information System. Formaldehyde (CASRN 50–00–0) [https://cfpub.epa.gov/ncea/iris2/chemicalLanding.cfm?substance\\_nmbr=419](https://cfpub.epa.gov/ncea/iris2/chemicalLanding.cfm?substance_nmbr=419).

<sup>1087</sup> NTP (National Toxicology Program). 2016. Report on Carcinogens, Fourteenth Edition.; Research Triangle Park, NC: U.S. Department of Health and Human Services, Public Health Service. <https://ntp.niehs.nih.gov/go/roc14>.

<sup>1088</sup> IARC Monographs on the Evaluation of Carcinogenic Risks to Humans Volume 88 (2006): Formaldehyde, 2-Butoxyethanol and 1-tert-Butoxypropan-2-ol.

<sup>1089</sup> IARC Monographs on the Evaluation of Carcinogenic Risks to Humans Volume 100F (2012): Formaldehyde.

<sup>1090</sup> Hauptmann, M.; Lubin, J.H.; Stewart, P.A.; Hayes, R.B.; Blair, A. 2003. Mortality from lymphohematopoietic malignancies among workers in formaldehyde industries. *Journal of the National Cancer Institute* 95: 1615–1623.

<sup>1091</sup> Hauptmann, M.; Lubin, J.H.; Stewart, P.A.; Hayes, R.B.; Blair, A. 2004. Mortality from solid cancers among workers in formaldehyde industries. *American Journal of Epidemiology* 159: 1117–1130.

<sup>1092</sup> Beane Freeman, L.E.; Blair, A.; Lubin, J.H.; Stewart, P.A.; Hayes, R.B.; Hoover, R.N.; Hauptmann, M. 2009. Mortality from lymphohematopoietic malignancies among workers in formaldehyde industries: The National Cancer Institute cohort. *J. National Cancer Inst.* 101: 751–761.

<sup>1093</sup> Pinkerton, L.E. 2004. Mortality among a cohort of garment workers exposed to formaldehyde: an update. *Occup. Environ. Med.* 61: 193–200.

<sup>1094</sup> Coggon, D, EC Harris, J Poole, KT Palmer. 2003. Extended follow-up of a cohort of British chemical workers exposed to formaldehyde. *J National Cancer Inst.* 95:1608–1615.

<sup>1095</sup> Hauptmann, M.; Stewart P.A.; Lubin J.H.; Beane Freeman, L.E.; Hornung, R.W.; Herrick, R.F.; Hoover, R.N.; Fraumeni, J.F.; Hayes, R.B. 2009. Mortality from lymphohematopoietic malignancies and brain cancer among embalmers exposed to formaldehyde. *Journal of the National Cancer Institute* 101:1696–1708.

<sup>1096</sup> ATSDR. 1999. Toxicological Profile for Formaldehyde, U.S. Department of Health and Human Services (HHS), July 1999.

<sup>1097</sup> ATSDR. 2010. Addendum to the Toxicological Profile for Formaldehyde. U.S. Department of Health and Human Services (HHS), October 2010.

<sup>1098</sup> IPCS. 2002. Concise International Chemical Assessment Document 40. Formaldehyde. World Health Organization.

<sup>1099</sup> EPA (U.S. Environmental Protection Agency). 2010. Toxicological Review of Formaldehyde (CAS No. 50–00–0)—Inhalation Assessment: In Support of Summary Information on the Integrated Risk Information System (IRIS). External Review Draft. EPA/635/R-10/002A. U.S. Environmental Protection Agency, Washington DC [online]. Available: [http://cfpub.epa.gov/ncea/iris\\_drafts/recordisplay.cfm?deid=223614](http://cfpub.epa.gov/ncea/iris_drafts/recordisplay.cfm?deid=223614).

<sup>1100</sup> NRC (National Research Council). 2011. Review of the Environmental Protection Agency’s

Continued

Children, especially neonates, appear to be more susceptible to acute naphthalene poisoning based on the number of reports of lethal cases in children and infants (hypothesized to be due to immature naphthalene detoxification pathways).<sup>1106</sup> EPA released an external review draft of a reassessment of the inhalation carcinogenicity of naphthalene based on a number of recent animal carcinogenicity studies.<sup>1107</sup> The draft reassessment completed external peer review.<sup>1108</sup> Based on external peer review comments received, EPA is developing a revised draft assessment that considers inhalation and oral routes of exposure, as well as cancer and noncancer effects.<sup>1109</sup> The external review draft does not represent official agency opinion and was released solely for the purposes of external peer review and public comment. The NTP listed naphthalene as “reasonably anticipated to be a human carcinogen” in 2004 on the basis of bioassays reporting clear evidence of carcinogenicity in rats and some evidence of carcinogenicity in mice.<sup>1110</sup> California EPA has released a new risk assessment for naphthalene, and the IARC has reevaluated naphthalene and re-classified it as Group 2B: possibly carcinogenic to humans.<sup>1111</sup>

Naphthalene also causes a number of non-cancer effects in animals following chronic and less-than-chronic exposure, including abnormal cell changes and

Assessment, Washington, DC. This material is available electronically at [https://cfpub.epa.gov/ncea/iris\\_drafts/recordisplay.cfm?deid=56434](https://cfpub.epa.gov/ncea/iris_drafts/recordisplay.cfm?deid=56434).

<sup>1106</sup> U.S. EPA. (1998). Toxicological Review of Naphthalene (Reassessment of the Inhalation Cancer Risk), Environmental Protection Agency, Integrated Risk Information System, Research and Development, National Center for Environmental Assessment, Washington, DC. This material is available electronically at [https://cfpub.epa.gov/ncea/iris\\_drafts/recordisplay.cfm?deid=56434](https://cfpub.epa.gov/ncea/iris_drafts/recordisplay.cfm?deid=56434).

<sup>1107</sup> U.S. EPA. (1998). Toxicological Review of Naphthalene (Reassessment of the Inhalation Cancer Risk), Environmental Protection Agency, Integrated Risk Information System, Research and Development, National Center for Environmental Assessment, Washington, DC. This material is available electronically at [https://cfpub.epa.gov/ncea/iris\\_drafts/recordisplay.cfm?deid=56434](https://cfpub.epa.gov/ncea/iris_drafts/recordisplay.cfm?deid=56434).

<sup>1108</sup> Oak Ridge Institute for Science and Education. (2004). External Peer Review for the IRIS Reassessment of the Inhalation Carcinogenicity of Naphthalene. August 2004. <http://cfpub.epa.gov/ncea/cfm/recordisplay.cfm?deid=84403>.

<sup>1109</sup> U.S. EPA. (2018) See: [https://cfpub.epa.gov/ncea/iris2/chemicalLanding.cfm?substance\\_nmbr=436](https://cfpub.epa.gov/ncea/iris2/chemicalLanding.cfm?substance_nmbr=436).

<sup>1110</sup> NTP (National Toxicology Program). 2016. Report on Carcinogens, Fourteenth Edition.; Research Triangle Park, NC: U.S. Department of Health and Human Services, Public Health Service. <https://ntp.niehs.nih.gov/go/roc14>.

<sup>1111</sup> International Agency for Research on Cancer (IARC). (2002). Monographs on the Evaluation of the Carcinogenic Risk of Chemicals for Humans. Vol. 82. Lyon, France.

growth in respiratory and nasal tissues.<sup>1112</sup> The current EPA IRIS assessment includes noncancer data on hyperplasia and metaplasia in nasal tissue that form the basis of the inhalation RfC of 3 µg/m<sup>3</sup>.<sup>1113</sup> The ATSDR MRL for acute and intermediate duration oral exposure to naphthalene is 0.6 mg/kg/day based on maternal toxicity in a developmental toxicology study in rats.<sup>1114</sup> ATSDR also derived an ad hoc reference value of 6 × 10<sup>-2</sup> mg/m<sup>3</sup> for acute (≤24-hour) inhalation exposure to naphthalene in a Letter Health Consultation dated March 24, 2014 to address a potential exposure concern in Illinois.<sup>1115</sup> The ATSDR acute inhalation reference value was based on a qualitative identification of an exposure level interpreted not to cause pulmonary lesions in mice. More recently, EPA developed acute RfCs for 1-, 8-, and 24-hour exposure scenarios; the ≤24-hour reference value is 2 × 10<sup>-2</sup> mg/m<sup>3</sup>.<sup>1116</sup> EPA’s acute RfCs are based on a systematic review of the literature, benchmark dose modeling of naphthalene-induced nasal lesions in rats, and application of a PBPK (physiologically based pharmacokinetic) model.

#### viii. Exposure and Health Effects Associated With Traffic

Locations near major roadways generally have elevated concentrations of many air pollutants emitted from motor vehicles. Hundreds of studies have been published in peer-reviewed journals, concluding that concentrations of CO, CO<sub>2</sub>, NO, NO<sub>2</sub>, benzene, aldehydes, particulate matter, black carbon, and many other compounds are elevated in ambient air within approximately 300–600 meters (about

<sup>1112</sup> U. S. EPA. (1998). Toxicological Review of Naphthalene, Environmental Protection Agency, Integrated Risk Information System, Research and Development, National Center for Environmental Assessment, Washington, DC. This material is available electronically at [https://cfpub.epa.gov/ncea/iris\\_drafts/recordisplay.cfm?deid=56434](https://cfpub.epa.gov/ncea/iris_drafts/recordisplay.cfm?deid=56434).

<sup>1113</sup> U.S. EPA. (1998). Toxicological Review of Naphthalene. Environmental Protection Agency, Integrated Risk Information System (IRIS), Research and Development, National Center for Environmental Assessment, Washington, DC [https://cfpub.epa.gov/ncea/iris\\_drafts/recordisplay.cfm?deid=56434](https://cfpub.epa.gov/ncea/iris_drafts/recordisplay.cfm?deid=56434).

<sup>1114</sup> ATSDR. Toxicological Profile for Naphthalene, 1-Methylnaphthalene, and 2-Methylnaphthalene (2005). <https://www.atsdr.cdc.gov/ToxProfiles/tp67-p.pdf>.

<sup>1115</sup> ATSDR. Letter Health Consultation, Radiac Abrasives, Inc., Chicago, Illinois (2014). [https://www.atsdr.cdc.gov/HAC/pha/RadiacAbrasives/Radiac%20Abrasives,%20Inc.%20%20LHC%20\(Final\)%20%2003-24-2014%20\(2\)\\_508.pdf](https://www.atsdr.cdc.gov/HAC/pha/RadiacAbrasives/Radiac%20Abrasives,%20Inc.%20%20LHC%20(Final)%20%2003-24-2014%20(2)_508.pdf).

<sup>1116</sup> U. S. EPA. Derivation of an acute reference concentration for inhalation exposure to naphthalene. Report No. EPA/600/R-21/292. <https://cfpub.epa.gov/ncea/risk/recordisplay.cfm?deid=355035>.

1,000–2,000 feet) of major roadways. The highest concentrations of most pollutants emitted directly by motor vehicles are found within 50 meters (about 165 feet) of the edge of a roadway’s traffic lanes.

A large-scale review of air quality measurements in the vicinity of major roadways between 1978 and 2008 concluded that the pollutants with the steepest concentration gradients in vicinities of roadways were CO, ultrafine particles, metals, elemental carbon (EC), NO, NO<sub>x</sub>, and several VOCs.<sup>1117</sup> These pollutants showed a large reduction in concentrations within 100 meters downwind of the roadway. Pollutants that showed more gradual reductions with distance from roadways included benzene, NO<sub>2</sub>, PM<sub>2.5</sub>, and PM<sub>10</sub>. In reviewing the literature, Karner et al. (2010) reported that results varied based on the method of statistical analysis used to determine the gradient in pollutant concentration. More recent studies of traffic-related air pollutants continue to report sharp gradients around roadways, particularly within

<sup>1117</sup> Karner, A.A.; Eisinger, D.S.; Niemeier, D.A. (2010). Near-roadway air quality: synthesizing the findings from real-world data. *Environ Sci Technol* 44: 5334–5344.

<sup>1118</sup> McDonald, B.C.; McBride, Z.C.; Martin, E.W.; Harley, R.A. (2014) High-resolution mapping of motor vehicle carbon dioxide emissions. *J. Geophys. Res. Atmos.*, 119, 5283–5298, doi:10.1002/2013JD021219.

<sup>1119</sup> Kimbrough, S.; Baldauf, R.W.; Hagler, G.S.W.; Shores, R.C.; Mitchell, W.; Whitaker, D.A.; Croghan, C.W.; Vallero, D.A. (2013) Long-term continuous measurement of near-road air pollution in Las Vegas: seasonal variability in traffic emissions impact on air quality. *Air Qual Atmos Health* 6: 295–305. DOI 10.1007/s11869-012-0171-x.

<sup>1120</sup> Kimbrough, S.; Palma, T.; Baldauf, R.W. (2014) Analysis of mobile source air toxics (MSATs)—Near-road VOC and carbonyl concentrations. *Journal of the Air & Waste Management Association*, 64:3, 349–359, DOI: 10.1080/10962247.2013.863814.

<sup>1121</sup> Kimbrough, S.; Owen, R.C.; Snyder, M.; Richmond-Bryant, J. (2017) NO to NO<sub>2</sub> Conversion Rate Analysis and Implications for Dispersion Model Chemistry Methods using Las Vegas, Nevada Near-Road Field Measurements. *Atmos Environ* 165: 23–24.

<sup>1122</sup> Apte, J.S.; Messier, K.P.; Gani, S.; Brauer, M.; Kirchstetter, T.W.; Lunden, M.M.; Marshall, J.D.; Portier, C.J.; Vermeulen, R.C.H.; Hamburg, S.P. (2017) High-Resolution Air Pollution Mapping with Google Street View Cars: Exploiting Big Data. *Environ Sci Technol* 51: 6999–7008. <https://doi.org/10.1021/acs.est.7b00891>.

<sup>1123</sup> Gu, P.; Li, H.Z.; Ye, Q.; et al. (2018) Intercity variability of particulate matter is driven by carbonaceous sources and correlated with land-use variables. *Environ Sci Technol* 52: 11545–11554. [Online at <http://dx.doi.org/10.1021/acs.est.8b03833>].

<sup>1124</sup> Hilker, N.; Wang, J.W.; Jong, C-H.; Healy, R.M.; Sofowote, U.; Debosz, J.; Su, Y.; Noble, M.; Munoz, A.; Doerkson, G.; White, L.; Audette, C.; Herod, D.; Brook, J.R.; Evans, G.J. (2019) Traffic-related air pollution near roadways: discerning local impacts from background. *Atmos. Meas. Tech.*, 12, 5247–5261. <https://doi.org/10.5194/amt-12-5247-2019>.

several hundred meters.<sup>1118 1119 1120 1121 1122 1123 1124 1125</sup> There is evidence that EPA's regulations for vehicles have lowered the near-road concentrations and gradients.<sup>1126</sup> Starting in 2010, EPA required through the NAAQS process that air quality monitors be placed near high-traffic roadways for determining concentrations of CO, NO<sub>2</sub>, and PM<sub>2.5</sub>. The monitoring data for NO<sub>2</sub> and CO indicate that in urban areas, monitors near roadways often report the highest concentrations.<sup>1127 1128</sup>

For pollutants with relatively high background concentrations relative to near-road concentrations, detecting concentration gradients can be difficult. For example, many carbonyls have high background concentrations because of photochemical breakdown of precursors from many different organic compounds. However, several studies have measured carbonyls in multiple weather conditions and found higher concentrations of many carbonyls downwind of roadways.<sup>1129 1130</sup> These findings suggest a substantial roadway source of these carbonyls.

In the past 30 years, many studies have been published with results reporting that populations who live, work, or go to school near high-traffic roadways experience higher rates of numerous adverse health effects, compared to populations far away from

major roads.<sup>1131</sup> In addition, numerous studies have found adverse health effects associated with spending time in traffic, such as commuting or walking along high-traffic roadways, including studies among children.<sup>1132 1133 1134 1135</sup>

Numerous reviews of this body of health literature have been published. In a 2022 final report, an expert panel of the Health Effects Institute (HEI) employed a systematic review focusing on selected health endpoints related to exposure to traffic-related air pollution.<sup>1136</sup> The HEI panel concluded that there was a high level of confidence in evidence between long-term exposure to traffic-related air pollution and health effects in adults, including all-cause, circulatory, and ischemic heart disease mortality.<sup>1137</sup> The panel also found that there is a moderate-to-high level of confidence in evidence of associations with asthma onset and acute respiratory infections in children and lung cancer and asthma onset in adults. The panel concluded that there was a moderate level of evidence of associations with small for gestational age births, but low-to-moderate confidence for other birth

outcomes (term birth weight and preterm birth). This report follows on an earlier expert review published by HEI in 2010, where it found strongest evidence for asthma-related traffic impacts. Other literature reviews have been published with conclusions generally similar to the HEI panels'.<sup>1138 1139 1140 1141</sup> Additionally, in 2014, researchers from the U.S. Centers for Disease Control and Prevention (CDC) published a systematic review and meta-analysis of studies evaluating the risk of childhood leukemia associated with traffic exposure and reported positive associations between postnatal proximity to traffic and leukemia risks, but no such association for prenatal exposures.<sup>1142</sup> The U.S. Department of Health and Human Services' National Toxicology Program published a monograph including a systematic review of traffic-related air pollution and its impacts on hypertensive disorders of pregnancy. The National Toxicology Program concluded that exposure to traffic-related air pollution is "presumed to be a hazard to pregnant women" for developing hypertensive disorders of pregnancy.<sup>1143</sup>

For several other health outcomes there are publications to suggest the possibility of an association with traffic-related air pollution, but insufficient evidence to draw definitive conclusions. Among these outcomes are neurological and cognitive impacts (e.g., autism and reduced cognitive function, academic performance, and executive function) and reproductive outcomes (e.g., preterm birth, low birth weight).<sup>1144 1145 1146 1147 1148 1149</sup>

<sup>1125</sup> Dabek-Zlotorzynska, E., V. Celo, L. Ding, D. Herod, C.-H. Jeong, G. Evans, and N. Hilker. 2019. "Characteristics and sources of PM<sub>2.5</sub> and reactive gases near roadways in two metropolitan areas in Canada." *Atmos Environ* 218: 116980.

<sup>1126</sup> Sarnat, J.A.; Russell, A.; Liang, D.; Moutinho, J.L.; Golan, R.; Weber, R.; Gao, D.; Sarnat, S.; Chang, H.H.; Greenwald, R.; Yu, T. (2018) Developing Multipollutant Exposure Indicators of Traffic Pollution: The Dorm Room Inhalation to Vehicle Emissions (DRIVE) Study. Health Effects Institute Research Report Number 196. [Online at: <https://www.healtheffects.org/publication/developing-multipollutant-exposure-indicators-traffic-pollution-dorm-room-inhalation>].

<sup>1127</sup> Gantt, B.; Owen, R.C.; Watkins, N. (2021) Characterizing nitrogen oxides and fine particulate matter near major highways in the United States using the National Near-road Monitoring Network. *Environ Sci Technol* 55: 2831–2838. [Online at <https://doi.org/10.1021/acs.est.0c05851>].

<sup>1128</sup> Lal, R.M.; Ramaswani, A.; Russell, A.G. (2020) Assessment of the near-road (monitoring) network including comparison with nearby monitors within U.S. cities. *Environ Res Letters* 15: 114026. [Online at <https://doi.org/10.1088/1748-9326/ab8156>].

<sup>1129</sup> Liu, W.; Zhang, J.; Kwon, J.I.; et al. (2006). Concentrations and source characteristics of airborne carbonyl compounds measured outside urban residences. *J Air Waste Manage Assoc* 56: 1196–1204.

<sup>1130</sup> Cahill, T.M.; Charles, M.J.; Seaman, V.Y. (2010). Development and application of a sensitive method to determine concentrations of acrolein and other carbonyls in ambient air. Health Effects Institute Research Report 149. Available at <https://www.healtheffects.org/system/files/Cahill149.pdf>.

<sup>1131</sup> In the widely used PubMed database of health publications, between January 1, 1990 and December 31, 2021, 1,979 publications contained the keywords "traffic, pollution, epidemiology," with approximately half the studies published after 2015.

<sup>1132</sup> Laden, F.; Hart, J.E.; Smith, T.J.; Davis, M.E.; Garshick, E. (2007) Cause-specific mortality in the unionized U.S. trucking industry. *Environmental Health Perspect* 115:1192–1196.

<sup>1133</sup> Peters, A.; von Klot, S.; Heier, M.; Trentinaglia, I.; Hörmann, A.; Wichmann, H.E.; Löwel, H. (2004) Exposure to traffic and the onset of myocardial infarction. *New England J Med* 351: 1721–1730.

<sup>1134</sup> Zanobetti, A.; Stone, P.H.; Spelzer, F.E.; Schwartz, J.D.; Coull, B.A.; Suh, H.H.; Nearing, B.D.; Mittleman, M.A.; Verrier, R.L.; Gold, D.R. (2009) T-wave alternans, air pollution and traffic in high-risk subjects. *Am J Cardiol* 104: 665–670.

<sup>1135</sup> Adar, S.; Adamkiewicz, G.; Gold, D.R.; Schwartz, J.; Coull, B.A.; Suh, H. (2007) Ambient and microenvironmental particles and exhaled nitric oxide before and after a group bus trip. *Environ Health Perspect* 115: 507–512.

<sup>1136</sup> HEI Panel on the Health Effects of Long-Term Exposure to Traffic-Related Air Pollution (2022) Systematic review and meta-analysis of selected health effects of long-term exposure to traffic-related air pollution. Health Effects Institute Special Report 23. [Online at <https://www.healtheffects.org/publication/systematic-review-and-meta-analysis-selected-health-effects-long-term-exposure-traffic>] This more recent review focused on health outcomes related to birth effects, respiratory effects, cardiometabolic effects, and mortality.

<sup>1137</sup> Boogaard, H.; Patton, A.P.; Atkinson, R.W.; Brook, J.R.; Chang, H.H.; Crouse, D.L.; Fussell, J.C.; Hoek, G.; Hoffmann, B.; Kappeler, R.; Kutlar Joss, M.; Ondras, M.; Sagiv, S.K.; Samoli, E.; Shaikh, R.; Smargiassi, A.; Szpiro, A.A.; Van Vliet, E.D.S.; Vienneau, D.; Weuve, J.; Lurmann, F.W.; Forastiere, F. (2022) Long-term exposure to traffic-related air pollution and selected health outcomes: A systematic review and meta-analysis. *Environ Internat* 164: 107262. [Online at <https://doi.org/10.1016/j.envint.2022.107262>].

<sup>1138</sup> Boothe, V.L.; Shendell, D.G. (2008). Potential health effects associated with residential proximity to freeways and primary roads: review of scientific literature, 1999–2006. *J Environ Health* 70: 33–41.

<sup>1139</sup> Salam, M.T.; Islam, T.; Gilliland, F.D. (2008). Recent evidence for adverse effects of residential proximity to traffic sources on asthma. *Curr Opin Pulm Med* 14: 3–8.

<sup>1140</sup> Sun, X.; Zhang, S.; Ma, X. (2014) No association between traffic density and risk of childhood leukemia: a meta-analysis. *Asia Pac J Cancer Prev* 15: 5229–5232.

<sup>1141</sup> Raaschou-Nielsen, O.; Reynolds, P. (2006). Air pollution and childhood cancer: a review of the epidemiological literature. *Int J Cancer* 118: 2920–9.

<sup>1142</sup> Boothe, V.L.; Boehmer, T.K.; Wendel, A.M.; Yip, F.Y. (2014) Residential traffic exposure and childhood leukemia: a systematic review and meta-analysis. *Am J Prev Med* 46: 413–422.

<sup>1143</sup> National Toxicology Program (2019) NTP Monograph on the Systematic Review of Traffic-Related Air Pollution and Hypertensive Disorders of Pregnancy. NTP Monograph 7. [https://ntp.niehs.nih.gov/ntp/ohat/trap/mgraph/trap\\_final\\_508.pdf](https://ntp.niehs.nih.gov/ntp/ohat/trap/mgraph/trap_final_508.pdf).

<sup>1144</sup> Volk, H.E.; Hertz-Picciotto, I.; Delwiche, L.; et al. (2011). Residential proximity to freeways and

Continued

Numerous studies have also investigated potential mechanisms by which traffic-related air pollution affects health, particularly for cardiopulmonary outcomes. For example, some research indicates that near-roadway exposures may increase systemic inflammation, affecting organ systems, including blood vessels and lungs.<sup>1150 1151 1152 1153</sup> Additionally, long-term exposures in near-road environments have been associated with inflammation-associated conditions, such as atherosclerosis and asthma.<sup>1154 1155 1156</sup>

As described in section VI.D.3, people who live or attend school near major roadways are more likely to be people

autism in the CHARGE study. *Environ Health Perspect* 119: 873–877.

<sup>1145</sup> Franco-Suglia, S.; Gryparis, A.; Wright, R.O.; et al. (2007). Association of black carbon with cognition among children in a prospective birth cohort study. *Am J Epidemiol*. doi: 10.1093/aje/kwm308. [Online at <http://dx.doi.org/>].

<sup>1146</sup> Power, M.C.; Weisskopf, M.G.; Alexeev, SE; et al. (2011). Traffic-related air pollution and cognitive function in a cohort of older men. *Environ Health Perspect* 2011: 682–687.

<sup>1147</sup> Wu, J.; Wilhelm, M.; Chung, J.; Ritz, B. (2011). Comparing exposure assessment methods for traffic-related air pollution in an adverse pregnancy outcome study. *Environ Res* 111: 685–692. <https://doi.org/10.1016/j.envres.2011.03.008>.

<sup>1148</sup> Stenson, C.; Wheeler, A.J.; Carver, A.; et al. (2021) The impact of traffic-related air pollution on child and adolescent academic performance: a systematic review. *Environ Intl* 155: 106696 [Online at <https://doi.org/10.1016/j.envint.2021.106696>].

<sup>1149</sup> Gartland, N.; Aljofi, H.E.; Dienes, K.; et al. (2022) The effects of traffic air pollution in and around schools on executive function and academic performance in children: a rapid review. *Int J Environ Res Public Health* 19: 749. <https://doi.org/10.3390/ijerph19020749>.

<sup>1150</sup> Riediker, M. (2007). Cardiovascular effects of fine particulate matter components in highway patrol officers. *Inhal Toxicol* 19: 99–105. doi: 10.1080/08958370701495238.

<sup>1151</sup> Alexeev, SE; Coull, B.A.; Gryparis, A.; et al. (2011). Medium-term exposure to traffic-related air pollution and markers of inflammation and endothelial function. *Environ Health Perspect* 119: 481–486. doi:10.1289/ehp.1002560.

<sup>1152</sup> Eckel, S.P.; Berhane, K.; Salam, M.T.; et al. (2011). Residential Traffic-related pollution exposure and exhaled nitric oxide in the Children’s Health Study. *Environ Health Perspect*. doi:10.1289/ehp.1103516.

<sup>1153</sup> Zhang, J.; McCreanor, J.E.; Cullinan, P.; et al. (2009). Health effects of real-world exposure diesel exhaust in persons with asthma. *Res Rep Health Effects Inst* 138. [Online at <http://www.healtheffects.org/>].

<sup>1154</sup> Adar, S.D.; Klein, R.; Klein, E.K.; et al. (2010). Air pollution and the microvasculature: a cross-sectional assessment of in vivo retinal images in the population-based Multi-Ethnic Study of Atherosclerosis. *PLoS Med* 7(11): E1000372. doi:10.1371/journal.pmed.1000372.

<sup>1155</sup> Kan, H.; Heiss, G.; Rose, K.M.; et al. (2008). Prospective analysis of traffic exposure as a risk factor for incident coronary heart disease: The Atherosclerosis Risk in Communities (ARIC) study. *Environ Health Perspect* 116: 1463–1468. doi:10.1289/ehp.11290.

<sup>1156</sup> McConnell, R.; Islam, T.; Shankardass, K.; et al. (2010). Childhood incident asthma and traffic-related air pollution at home and school. *Environ Health Perspect* 1021–1026.

of color and/or have a low SES. Additionally, people with low SES often live in neighborhoods with multiple stressors and health risk factors, including reduced health insurance coverage rates, higher smoking and drug use rates, limited access to fresh food, visible neighborhood violence, and elevated rates of obesity and some diseases such as asthma, diabetes, and ischemic heart disease. Although questions remain, several studies find stronger associations between air pollution and health in locations with such chronic neighborhood stress, suggesting that populations in these areas may be more susceptible to the effects of air pollution.<sup>1157 1158 1159 1160 1161 1162 1163 1164</sup>

The risks associated with residence, workplace, or school near major roads are of potentially high public health significance due to the large population in such locations. We analyzed several data sets to estimate the size of populations living or attending school near major roads. Our evaluation of environmental justice concerns in these studies is presented in section VI.D.3 of this preamble.

Every two years from 1997 to 2009 and in 2011 and 2013, the U.S. Census Bureau’s American Housing Survey (AHS) conducted a survey that includes

<sup>1157</sup> Islam, T.; Urban, R.; Gauderman, W.J.; et al. (2011). Parental stress increases the detrimental effect of traffic exposure on children’s lung function. *Am J Respir Crit Care Med*.

<sup>1158</sup> Clougherty, J.E.; Kubzansky, L.D. (2009) A framework for examining social stress and susceptibility to air pollution in respiratory health. *Environ Health Perspect* 117: 1351–1358. doi:10.1289/ehp.0900612.

<sup>1159</sup> Clougherty, J.E.; Levy, J.I.; Kubzansky, L.D.; Ryan, P.B.; Franco Suglia, S.; Jacobson Canner, M.; Wright, R.J. (2007) Synergistic effects of traffic-related air pollution and exposure to violence on urban asthma etiology. *Environ Health Perspect* 115: 1140–1146. doi:10.1289/ehp.9863.

<sup>1160</sup> Finkelstein, M.M.; Jerrett, M.; DeLuca, P.; Finkelstein, N.; Verma, D.K.; Chapman, K.; Sears, M.R. (2003) Relation between income, air pollution and mortality: a cohort study. *Canadian Med Assn J* 169: 397–402.

<sup>1161</sup> Shankardass, K.; McConnell, R.; Jerrett, M.; Milam, J.; Richardson, J.; Berhane, K. (2009) Parental stress increases the effect of traffic-related air pollution on childhood asthma incidence. *Proc Natl Acad Sci* 106: 12406–12411. doi:10.1073/pnas.0812910106.

<sup>1162</sup> Chen, E.; Schrier, H.M.; Strunk, R.C.; et al. (2008). Chronic traffic-related air pollution and stress interact to predict biologic and clinical outcomes in asthma. *Environ Health Perspect* 116: 970–5.

<sup>1163</sup> Currie, J. and R. Walker (2011) Traffic Congestion and Infant Health: Evidence from E-ZPass. *American Economic Journal: Applied Economics*, 3 (1): 65–90. <https://doi.org/10.1257/app.3.1.65>.

<sup>1164</sup> Knittel, C.R.; Miller, D.L.; Sanders N.J. (2016) Caution, Drivers! Children Present: Traffic, Pollution, and Infant Health. *The Review of Economics and Statistics*, 98 (2): 350–366. [https://doi.org/10.1162/REST\\_a\\_00548](https://doi.org/10.1162/REST_a_00548).

whether housing units are within 300 feet of an “airport, railroad, or highway with four or more lanes.”<sup>1165</sup> The 2013 AHS reports that 17.3 million housing units, or 13 percent of all housing units in the United States, were in such areas. Assuming that populations and housing units are in the same locations, this corresponds to a population of more than 41 million U.S. residents near high-traffic roadways or other transportation sources.<sup>1166</sup> According to the Central Intelligence Agency’s World Factbook, based on data collected between 2012–2022, the United States had 6,586,610 km of roadways, 293,564 km of railways, and 13,513 airports.<sup>1167</sup> As such, highways represent the overwhelming majority of transportation facilities described by this factor in the AHS.

In examining schools near major roadways, we used the Common Core of Data from the U.S. Department of Education, which includes information on all public elementary and secondary schools and school districts nationwide.<sup>1168</sup> To determine school proximities to major roadways, we used a geographic information system (GIS) to map each school and roadway based on the U.S. Census’s TIGER roadway file.<sup>1169</sup> We estimated that about 10 million students attend public schools within 200 meters of major roads, about 20 percent of the total number of public school students in the U.S.<sup>1170 1171 1172</sup>

<sup>1165</sup> The variable was known as “ETTRANS” in the questions about the neighborhood.

<sup>1166</sup> The analysis of population living near major roads based on the Freight Analysis Framework, version 4 is intended to provide comparable estimates as the AHS analyses for the conterminous United States (*i.e.*, “the lower 48”). Population estimates for the two methods result in very good agreement—41 million people living within 300 feet/100 meters using the AHS 2009 dataset, and 41 million people living within 100 meters of a road in the FAF4 network using the data in that analysis.

<sup>1167</sup> Central Intelligence Agency. *World Factbook: United States*. [Online at <https://www.cia.gov/the-world-factbook/countries/united-states/#transportation>].

<sup>1168</sup> <http://nces.ed.gov/ccd/>.

<sup>1169</sup> Pedde, M.; Bailey, C. (2011) Identification of Schools within 200 Meters of U.S. Primary and Secondary Roads. Memorandum to the docket.

<sup>1170</sup> Pedde, M.; Bailey, C. (2011) Identification of Schools within 200 Meters of U.S. Primary and Secondary Roads. Memorandum to the docket.

<sup>1171</sup> Here, “major roads” refer to those TIGER classifies as either “Primary” or “Secondary”. The Census Bureau describes primary roads as “generally divided limited-access highways within the Federal interstate system or under state management”. Secondary roads are “main arteries, usually in the U.S. highway, state highway, or county highway system”.

<sup>1172</sup> For this analysis we analyzed a 200-meter distance based on the understanding that roadways generally influence air quality within a few hundred meters from the vicinity of heavily traveled roadways or along corridors with significant trucking traffic. See U.S. EPA, 2014.

About 800,000 students attend public schools within 200 meters of primary roads, or about 2 percent of the total.

EPA also conducted a study to estimate the number of people living near truck freight routes in the United States, which includes many large highways and other routes where light- and medium-duty vehicles operate.<sup>1173</sup> Based on a population analysis using the U.S. Department of Transportation's (USDOT) Freight Analysis Framework 4 (FAF4) and population data from the 2010 decennial census, an estimated 72 million people live within 200 meters of these FAF4 roads, which are used by all types of vehicles.<sup>1174</sup> The FAF4 analysis includes the population living within 200 meters of major roads, while the AHS uses a 100-meter distance; the larger distance and other methodological differences explain the difference in the two estimates for populations living near major roads.<sup>1175</sup>

The EPA's Exposure Factor Handbook also indicates that, on average, Americans spend more than an hour traveling each day, bringing nearly all residents into a high-exposure microenvironment for part of the day.<sup>1176 1177</sup> While near-roadway studies focus on residents near roads or others spending considerable time near major roads, the duration of commuting results in another important contributor to overall exposure to traffic-related air pollution. Studies of health that address

Near Roadway Air Pollution and Health: Frequently Asked Questions. EPA-420-F-14-044.

<sup>1173</sup> U.S. EPA (2021). Estimation of Population Size and Demographic Characteristics among People Living Near Truck Routes in the Conterminous United States. Memorandum to the Docket.

<sup>1174</sup> FAF4 is a model from the USDOT's Bureau of Transportation Statistics (BTS) and Federal Highway Administration (FHWA), which provides data associated with freight movement in the U.S. It includes data from the 2012 Commodity Flow Survey (CFS), the Census Bureau on international trade, as well as data associated with construction, agriculture, utilities, warehouses, and other industries. FAF4 estimates the modal choices for moving goods by trucks, trains, boats, and other types of freight modes. It includes traffic assignments, including truck flows on a network of truck routes. [https://ops.fhwa.dot.gov/freight/freight\\_analysis/faf/](https://ops.fhwa.dot.gov/freight/freight_analysis/faf/).

<sup>1175</sup> The same analysis estimated the population living within 100 meters of a FAF4 truck route is 41 million.

<sup>1176</sup> EPA. (2011) Exposure Factors Handbook: 2011 Edition. Chapter 16. Online at <https://www.epa.gov/expobox/about-exposure-factors-handbook>.

<sup>1177</sup> It is not yet possible to estimate the long-term impact of growth in telework associated with the COVID-19 pandemic on travel behavior. There were notable changes during the pandemic. For example, according to the 2021 American Time Use Survey, a greater fraction of workers did at least part of their work at home (38%) as compared with the 2019 survey (24%). [Online at <https://www.bls.gov/news.release/atus.nr0.htm>].

time spent in transit have found evidence of elevated risk of cardiac impacts.<sup>1178 1179 1180</sup> Studies have also found that school bus emissions can increase student exposures to diesel-related air pollutants, and that programs that reduce school bus emissions may improve health and reduce school absenteeism.<sup>1181 1182 1183 1184</sup>

### 3. Welfare Effects Associated With Exposure to Non-GHG Pollutants

This section discusses the environmental effects associated with non-GHG pollutants affected by this rule, specifically particulate matter, ozone, NO<sub>x</sub>, SO<sub>x</sub>, and air toxics.

#### i. Visibility

Visibility can be defined as the degree to which the atmosphere is transparent to visible light.<sup>1185</sup> Visibility impairment is caused by light scattering and absorption by suspended particles and gases. It is dominated by contributions from suspended particles except under pristine conditions. Visibility is important because it has direct significance to people's enjoyment of daily activities in all parts of the country. Individuals value good visibility for the well-being it provides them directly, where they live and work, and in places where they enjoy recreational opportunities. Visibility is also highly valued in significant natural

<sup>1178</sup> Riediker, M.; Cascio, W.E.; Griggs, T.R.; et al. (2004) Particulate matter exposure in cars is associated with cardiovascular effects in healthy young men. *Am J Respir Crit Care Med* 169. [Online at <https://doi.org/10.1164/rccm.200310-1463OC>].

<sup>1179</sup> Peters, A.; von Klot, S.; Heier, M.; et al. (2004) Exposure to traffic and the onset of myocardial infarction. *New Engl J Med* 1721-1730. [Online at <https://doi.org/10.1056/NEJMoa040203>].

<sup>1180</sup> Adar, S.D.; Gold, D.R.; Coull, B.A.; (2007) Focused exposure to airborne traffic particles and heart rate variability in the elderly. *Epidemiology* 18: 95-103 [Online at 351: <https://doi.org/10.1097/01.ede.0000249409.81050.46>].

<sup>1181</sup> Sabin, L.; Behrentz, E.; Winer, A.M.; et al. Characterizing the range of children's air pollutant exposure during school bus commutes. *J Expo Anal Environ Epidemiol* 15: 377-387. [Online at <https://doi.org/10.1038/sj.jea.7500414>].

<sup>1182</sup> Li, C.; N, Q.; Ryan, P.H.; School bus pollution and changes in the air quality at schools: a case study. *J Environ Monit* 11: 1037-1042. [<https://doi.org/10.1039/b19458k>].

<sup>1183</sup> Austin, W.; Heutel, G.; Kreisman, D. (2019) School bus emissions, student health and academic performance. *Econ Edu Rev* 70: 108-12.

<sup>1184</sup> Adar, S.D.; D.Souza, J.; Sheppard, L.; et al. (2015) Adopting clean fuels and technologies on school buses. Pollution and health impacts in children. *Am J Respir Crit Care Med* 191. [Online at <https://doi.org/10.1164/rccm.201410-1924OC>].

<sup>1185</sup> National Research Council, (1993). Protecting Visibility in National Parks and Wilderness Areas. National Academy of Sciences Committee on Haze in National Parks and Wilderness Areas. National Academy Press, Washington, DC. This book can be viewed on the National Academy Press website at <https://www.nap.edu/catalog/2097/protecting-visibility-in-national-parks-and-wilderness-areas>.

areas, such as national parks and wilderness areas, and special emphasis is given to protecting visibility in these areas. For more information on visibility see the final 2019 PM ISA.<sup>1186</sup>

EPA is working to address visibility impairment. Reductions in air pollution from implementation of various programs associated with the Clean Air Act Amendments of 1990 provisions have resulted in substantial improvements in visibility and will continue to do so in the future. Nationally, because trends in haze are closely associated with trends in particulate sulfate and nitrate due to the relationship between their concentration and light extinction, visibility trends have improved as emissions of SO<sub>2</sub> and NO<sub>x</sub> have decreased over time due to air pollution regulations such as the Acid Rain Program.<sup>1187</sup> However, in the western part of the country, changes in total light extinction were smaller, and the contribution of particulate organic matter to atmospheric light extinction was increasing due to increasing wildfire emissions.<sup>1188</sup>

In the Clean Air Act Amendments of 1977, Congress recognized visibility's value to society by establishing a national goal to protect national parks and wilderness areas from visibility impairment caused by manmade pollution.<sup>1189</sup> In 1999, EPA finalized the regional haze program to protect the visibility in Mandatory Class I Federal areas.<sup>1190</sup> There are 156 national parks, forests and wilderness areas categorized as Mandatory Class I Federal areas.<sup>1191</sup> These areas are defined in CAA section 162 as those national parks exceeding 6,000 acres, wilderness areas and memorial parks exceeding 5,000 acres, and all international parks which were in existence on August 7, 1977.

EPA has also concluded that PM<sub>2.5</sub> causes adverse effects on visibility in other areas that are not targeted by the Regional Haze Rule, such as urban areas, depending on PM<sub>2.5</sub> concentrations and other factors such as dry chemical composition and relative

<sup>1186</sup> U.S. EPA. Integrated Science Assessment (ISA) for Particulate Matter (Final Report, 2019). U.S. Environmental Protection Agency, Washington, DC, EPA/600/R-19/188, 2019.

<sup>1187</sup> U.S. EPA. Integrated Science Assessment (ISA) for Particulate Matter (Final Report, 2019). U.S. Environmental Protection Agency, Washington, DC, EPA/600/R-19/188, 2019.

<sup>1188</sup> Hand, J.L.; Prenni, A.J.; Copeland, S.; Schichtel, B.A.; Malm, W.C. (2020). Thirty years of the Clean Air Act Amendments: Impacts on haze in remote regions of the United States (1990-2018). *Atmos Environ* 243: 117865.

<sup>1189</sup> See CAA section 169(a).

<sup>1190</sup> 64 FR 35714, July 1, 1999.

<sup>1191</sup> 62 FR 38680-38681, July 18, 1997.

humidity (*i.e.*, an indicator of the water composition of the particles). The secondary (welfare-based) PM NAAQS provide protection against visibility effects. In recent PM NAAQS reviews, EPA evaluated a target level of protection for visibility impairment that is expected to be met through attainment of the existing secondary PM standards.

ii. Ozone Effects on Ecosystems

The welfare effects of ozone include effects on ecosystems, which can be observed across a variety of scales, *i.e.*, subcellular, cellular, leaf, whole plant, population and ecosystem. Ozone effects that begin at small spatial scales, such as the leaf of an individual plant, when they occur at sufficient magnitudes (or to a sufficient degree) can result in effects being propagated to higher and higher levels of biological organization. For example, effects at the individual plant level, such as altered rates of leaf gas exchange, growth and reproduction, can, when widespread, result in broad changes in ecosystems, such as productivity, carbon storage, water cycling, nutrient cycling, and community composition.

Ozone can produce both acute and chronic injury in sensitive plant species depending on the concentration level and the duration of the exposure.<sup>1192</sup> In those sensitive species,<sup>1193</sup> effects from repeated exposure to ozone throughout the growing season of the plant can tend to accumulate, so even relatively low concentrations experienced for a longer duration have the potential to create chronic stress on vegetation.<sup>1194 1195</sup> Ozone damage to sensitive plant species includes impaired photosynthesis and visible injury to leaves. The impairment of photosynthesis, the process by which the plant makes carbohydrates (its source of energy and food), can lead to reduced crop yields, timber production, and plant productivity and growth. Impaired photosynthesis can also lead to a reduction in root growth and carbohydrate storage below ground, resulting in other, more subtle plant and

ecosystems impacts.<sup>1196</sup> These latter impacts include increased susceptibility of plants to insect attack, disease, harsh weather, interspecies competition and overall decreased plant vigor. The adverse effects of ozone on areas with sensitive species could potentially lead to species shifts and loss from the affected ecosystems,<sup>1197</sup> resulting in a loss or reduction in associated ecosystem goods and services. Additionally, visible ozone injury to leaves can result in a loss of aesthetic value in areas of special scenic significance like national parks and wilderness areas and reduced use of sensitive ornamentals in landscaping.<sup>1198</sup> In addition to ozone effects on vegetation, newer evidence suggests that ozone affects interactions between plants and insects by altering chemical signals (*e.g.*, floral scents) that plants use to communicate to other community members, such as attraction of pollinators.

The Ozone ISA presents more detailed information on how ozone affects vegetation and ecosystems.<sup>1199</sup> The Ozone ISA reports causal and likely causal relationships between ozone exposure and a number of welfare effects and characterizes the weight of evidence for different effects associated with ozone.<sup>1200</sup> The Ozone ISA concludes that visible foliar injury effects on vegetation, reduced vegetation growth, reduced plant reproduction, reduced productivity in terrestrial ecosystems, reduced yield and quality of agricultural crops, alteration of below-ground biogeochemical cycles, and altered terrestrial community composition are causally associated with exposure to ozone. It also concludes that increased tree mortality, altered herbivore growth and reproduction, altered plant-insect signaling, reduced carbon sequestration in terrestrial ecosystems, and alteration of terrestrial ecosystem water cycling

are likely to be causally associated with exposure to ozone.

iii. Deposition

The Integrated Science Assessment for Oxides of Nitrogen, Oxides of Sulfur, and Particulate Matter—Ecological Criteria documents the ecological effects of the deposition of these criteria air pollutants.<sup>1201</sup> It is clear from the body of evidence that oxides of nitrogen, oxides of sulfur, and particulate matter contribute to total nitrogen (N) and sulfur (S) deposition. In turn, N and S deposition cause either nutrient enrichment or acidification depending on the sensitivity of the landscape or the species in question. Both enrichment and acidification are characterized by an alteration of the biogeochemistry and the physiology of organisms, resulting in ecologically harmful declines in biodiversity in terrestrial, freshwater, wetland, and estuarine ecosystems in the U.S. Decreases in biodiversity mean that some species become relatively less abundant and may be locally extirpated. In addition to the potential loss of unique living species, the decline in total biodiversity can be harmful because biodiversity is an important determinant of the stability of ecosystems and their ability to provide socially valuable ecosystem services.

Terrestrial, wetland, freshwater, and estuarine ecosystems in the U.S. are affected by nitrogen enrichment/eutrophication caused by nitrogen deposition. These effects, though improving recently as emissions and deposition decline, have been consistently documented across the United States for hundreds of species and have likely been occurring for decades. In terrestrial systems nitrogen loading can lead to loss of nitrogen-sensitive plant and lichen species, decreased biodiversity of grasslands, meadows and other sensitive habitats, and increased potential for invasive species and potentially for wildfire. In aquatic systems nitrogen loading can alter species assemblages and cause eutrophication.

The sensitivity of terrestrial and aquatic ecosystems to acidification from nitrogen and sulfur deposition is predominantly governed by the intersection of geology and deposition. Prolonged exposure to excess nitrogen and sulfur deposition in sensitive areas acidifies lakes, rivers, and soils. Increased acidity in surface waters creates inhospitable conditions for biota

<sup>1192</sup> 73 FR 16486, March 27, 2008.

<sup>1193</sup> Only a small percentage of all the plant species growing within the U.S. (over 43,000 species have been catalogued in the USDA PLANTS database) have been studied with respect to ozone sensitivity.

<sup>1194</sup> U.S. EPA. Integrated Science Assessment (ISA) for Ozone and Related Photochemical Oxidants (Final Report). U.S. Environmental Protection Agency, Washington, DC, EPA/600/R-20/012, 2020.

<sup>1195</sup> The concentration at which ozone levels overwhelm a plant's ability to detoxify or compensate for oxidant exposure varies. Thus, whether a plant is classified as sensitive or tolerant depends in part on the exposure levels being considered.

<sup>1196</sup> 73 FR 16492, March 27, 2008.

<sup>1197</sup> 73 FR 16493–16494, March 27, 2008. Ozone impacts could be occurring in areas where plant species sensitive to ozone have not yet been studied or identified.

<sup>1198</sup> 73 FR 16490–16497, March 27, 2008.

<sup>1199</sup> U.S. EPA. Integrated Science Assessment (ISA) for Ozone and Related Photochemical Oxidants (Final Report). U.S. Environmental Protection Agency, Washington, DC, EPA/600/R-20/012, 2020.

<sup>1200</sup> The Ozone ISA evaluates the evidence associated with different ozone related health and welfare effects, assigning one of five “weight of evidence” determinations: causal relationship, likely to be a causal relationship, suggestive of a causal relationship, inadequate to infer a causal relationship, and not likely to be a causal relationship. For more information on these levels of evidence, please refer to Table II of the ISA.

<sup>1201</sup> U.S. EPA. Integrated Science Assessment (ISA) for Oxides of Nitrogen, Oxides of Sulfur and Particulate Matter Ecological Criteria (Final Report). U.S. Environmental Protection Agency, Washington, DC, EPA/600/R-20/278, 2020.

and affects the abundance and biodiversity of fishes, zooplankton and macroinvertebrates and ecosystem function. Over time, acidifying deposition also removes essential nutrients from forest soils, depleting the capacity of soils to neutralize future acid loadings and negatively affecting forest sustainability. Major effects in forests include a decline in sensitive tree species, such as red spruce (*Picea rubens*) and sugar maple (*Acer saccharum*).

Building materials including metals, stones, cements, and paints undergo natural weathering processes from exposure to environmental elements (e.g., wind, moisture, temperature fluctuations, sunlight, etc.). Pollution can worsen and accelerate these effects. Deposition of PM is associated with both physical damage (materials damage effects) and impaired aesthetic qualities (soiling effects). Wet and dry deposition of PM can physically affect materials, adding to the effects of natural weathering processes, by potentially promoting or accelerating the corrosion of metals, by degrading paints and by deteriorating building materials such as stone, concrete and marble.<sup>1202</sup> The effects of PM are exacerbated by the presence of acidic gases and can be additive or synergistic due to the complex mixture of pollutants in the air and surface characteristics of the material. Acidic deposition has been shown to have an effect on materials including zinc/galvanized steel and other metal, carbonate stone (as monuments and building facings), and surface coatings (paints).<sup>1203</sup> The effects on historic buildings and outdoor works of art are of particular concern because of the uniqueness and irreplaceability of many of these objects. In addition to aesthetic and functional effects on metals, stone and glass, altered energy efficiency of photovoltaic panels by PM deposition is also an emerging consideration for impacts of air pollutants on materials.

#### iv. Welfare Effects Associated With Air Toxics

Emissions from producing, transporting, and combusting fuel contribute to ambient levels of pollutants that contribute to adverse effects on vegetation. Volatile organic

compounds (VOCs), some of which are considered air toxics, have long been suspected to play a role in vegetation damage.<sup>1204</sup> In laboratory experiments, a wide range of tolerance to VOCs has been observed.<sup>1205</sup> Decreases in harvested seed pod weight have been reported for the more sensitive plants, and some studies have reported effects on seed germination, flowering, and fruit ripening. Effects of individual VOCs or their role in conjunction with other stressors (e.g., acidification, drought, temperature extremes) have not been well studied. In a recent study of a mixture of VOCs including ethanol and toluene on herbaceous plants, significant effects on seed production, leaf water content, and photosynthetic efficiency were reported for some plant species.<sup>1206</sup>

Research suggests an adverse impact of vehicle exhaust on plants, which has in some cases been attributed to aromatic compounds and in other cases to.<sup>1207 1208 1209</sup> The impacts of VOCs on plant reproduction may have long-term implications for biodiversity and survival of native species near major roadways. Most of the studies of the impacts of VOCs on vegetation have focused on short-term exposure, and few studies have focused on long-term effects of VOCs on vegetation and the potential for metabolites of these compounds to affect herbivores or insects.

#### C. Air Quality Impacts of Non-GHG Pollutants

Section V of this preamble presents projections of the changes in criteria pollutant and air toxics emissions due to the final rule. We did not conduct air quality modeling for this rule, and making predictions based solely on emissions changes is extremely difficult;

the atmospheric chemistry related to ambient concentrations of PM<sub>2.5</sub>, ozone and air toxics is very complex, and the emissions changes are spatially variable. Nevertheless, we do expect that in areas in close proximity to roadways (i.e., within 300–600 meters of the roadway), the reductions in vehicle emissions will decrease ambient levels of PM<sub>2.5</sub>, NO<sub>2</sub>, and other traffic-related pollutants described in section VI.B. Across broader geographic areas, we also expect the decrease in vehicle emissions to contribute to lower ambient concentrations of ozone and PM<sub>2.5</sub>, which are secondarily formed in the atmosphere. Section V of this preamble also describes projected potential emission reductions downwind from refineries, which would improve air quality in those locations. Increased emissions from EGUs may increase ambient concentrations of some pollutants in downwind areas, although those impacts will lessen over time as the power sector becomes cleaner.

#### D. Environmental Justice

##### 1. Overview

Communities with environmental justice concerns, which can include a range of communities and populations, face relatively greater cumulative impacts associated with environmental exposures of multiple types, as well as impacts from non-chemical stressors.<sup>1210 1211 1212 1213</sup> As described in section VI.B.2, there is some literature to suggest that different sociodemographic factors may increase susceptibility to the effects of traffic-associated air pollution. In addition, compared to non-Hispanic Whites, some other racial groups experience greater levels of health problems during some life stages. For example, in 2018–2020, about 12 percent of non-Hispanic Black; 9 percent of non-Hispanic American Indian/Alaska Native; and 7 percent of Hispanic children were estimated to currently have asthma, compared with 6 percent of non-Hispanic White

<sup>1204</sup> U.S. EPA. (1991). Effects of organic chemicals in the atmosphere on terrestrial plants. EPA/600/3-91/001.

<sup>1205</sup> Cape JN, ID Leith, J Binnie, J Content, M Donkin, M Skewes, DN Price AR Brown, AD Sharpe. (2003). Effects of VOCs on herbaceous plants in an open-top chamber experiment. *Environ. Pollut.* 124:341–343.

<sup>1206</sup> Cape JN, ID Leith, J Binnie, J Content, M Donkin, M Skewes, DN Price AR Brown, AD Sharpe. (2003). Effects of VOCs on herbaceous plants in an open-top chamber experiment. *Environ. Pollut.* 124:341–343.

<sup>1207</sup> Viskari E-L. (2000). Epicuticular wax of Norway spruce needles as indicator of traffic pollutant deposition. *Water, Air, and Soil Pollut.* 121:327–337.

<sup>1208</sup> Ugrehelidze D, F Korte, G Kvesitadze. (1997). Uptake and transformation of benzene and toluene by plant leaves. *Ecotox. Environ. Safety* 37:24–29.

<sup>1209</sup> Kammerbauer H, H Selinger, R Rommelt, A Ziegler-Jons, D Knoppik, B Hock. (1987). Toxic components of motor vehicle emissions for the spruce *Picea abies*. *Environ. Pollut.* 48:235–243.

<sup>1210</sup> Rowangould, G.M. (2013) A census of the near-roadway population: public health and environmental justice considerations. *Trans Res D* 25: 59–67. <http://dx.doi.org/10.1016/j.trd.2013.08.003>.

<sup>1211</sup> Marshall, J.D. (2000) Environmental inequality: Air pollution exposures in California's South Coast Air Basin. *Atmos Environ* 21: 5499–5503. <https://doi.org/10.1016/j.atmosenv.2008.02.005>.

<sup>1212</sup> Marshall, J.D. (2008) Environmental inequality: air pollution exposures in California's South Coast Air Basin. *Atmos Environ* 21: 5499–5503. <https://doi.org/10.1016/j.atmosenv.2008.02.005>.

<sup>1213</sup> Mohai, P.; Pellow, D.; Roberts Timmons, J. (2009) Environmental justice. *Annual Reviews* 34: 405–430. <https://doi.org/10.1146/annurev-environ082508-094348>.

<sup>1202</sup> U.S. EPA. Integrated Science Assessment (ISA) for Particulate Matter (Final Report, 2019). U.S. Environmental Protection Agency, Washington, DC, EPA/600/R-19/188, 2019.

<sup>1203</sup> Irving, P.M., e.d. 1991. Acid Deposition: State of Science and Technology, Volume III, Terrestrial, Materials, Health, and Visibility Effects, The U.S. National Acid Precipitation Assessment Program, Chapter 24, page 24–76.

children.<sup>1214</sup> Nationally, on average, non-Hispanic Black and non-Hispanic American Indian or Alaska Native people also have lower than average life expectancy based on 2019 data.<sup>1215</sup>

EPA's 2016 "Technical Guidance for Assessing Environmental Justice in Regulatory Analysis" provides recommendations on conducting the highest quality analysis feasible of environmental justice (EJ) issues associated with a given regulatory decision, though it is not prescriptive, recognizing that data limitations, time and resource constraints, and analytic challenges will vary by media and regulatory context.<sup>1216</sup> Where applicable and practicable, the Agency endeavors to conduct such an EJ analysis. There is evidence that communities with EJ concerns are disproportionately and adversely impacted by heavy-duty vehicle emissions.<sup>1217</sup>

In section VI.D.2, we discuss the EJ impacts of this final rule's GHG emission standards from the anticipated reduction of GHGs. We also discuss in section VI.D.3 the potential additional EJ impacts from the non-GHG (criteria pollutant and air toxic) emissions changes we estimate would result from compliance with the CO<sub>2</sub> emission standards, including impacts near roadways and from upstream sources. EPA did not consider potential adverse disproportionate impacts of vehicle emissions in selecting the CO<sub>2</sub> emission standards, but we provide information about adverse impacts of vehicle emissions for the public's understanding of this rulemaking, which addresses the need to protect public health consistent with CAA section 202(a)(1)–(2). When assessing the potential for disproportionate and adverse health or environmental impacts of regulatory actions on populations with potential EJ concerns, EPA strives to answer the following three broad questions, for purposes of

the EJ analysis: (1) Is there evidence of potential EJ concerns in the baseline (the state of the world absent the regulatory action)? Assessing the baseline will allow EPA to determine whether pre-existing disparities are associated with the pollutant(s) under consideration (e.g., if the effects of the pollutant(s) are more concentrated in some population groups); (2) Is there evidence of potential EJ concerns for the regulatory option(s) under consideration? Specifically, how are the pollutant(s) and its effects distributed for the regulatory options under consideration?; and (3) Do the regulatory option(s) under consideration exacerbate or mitigate EJ concerns relative to the baseline? It is not always possible to provide quantitative answers to these questions.

EPA received several comments related to the environmental justice impacts of heavy-duty vehicles in general and the impacts of the proposal specifically. We summarize and respond to those comments in section 18 of the Response to Comments document that accompanies this rulemaking. After consideration of comments, EPA updated our review of the literature, while maintaining our general approach to the environmental justice analysis. We note that analyses in this section are based on data that was the most appropriate recent data at the time we undertook the analyses. We intend to continue analyzing data concerning disproportionate impacts of pollution in the future, using the latest available data.

## 2. GHG Impacts on Environmental Justice and Vulnerable or Overburdened Populations

In the 2009 Endangerment Finding, the Administrator considered how climate change threatens the health and welfare of the U.S. population. As part of that consideration, she also considered risks to people of color and low-income individuals and communities, finding that certain parts of the U.S. population may be especially vulnerable based on their characteristics or circumstances. These groups include economically and socially disadvantaged communities; individuals at vulnerable life stages, such as the elderly, the very young, and pregnant or nursing women; those already in poor health or with comorbidities; the disabled; those experiencing homelessness, mental illness, or substance abuse; and Indigenous or other populations dependent on one or limited resources for subsistence due to factors including

but not limited to geography, access, and mobility.

Scientific assessment reports produced over the past decade by the USGCRP,<sup>1218,1219</sup> the IPCC,<sup>1220,1221,1222,1223</sup> the National Academies of Science, Engineering, and

<sup>1218</sup> USGCRP, 2018: Impacts, Risks, and Adaptation in the United States: Fourth National Climate Assessment, Volume II [Reidmiller, D.R., C.W. Avery, D.R. Easterling, K.E. Kunkel, K.L.M. Lewis, T.K. Maycock, and B.C. Stewart (eds.)]. U.S. Global Change Research Program, Washington, DC, USA, 1515 pp. doi:10.7930/NCA4.2018.

<sup>1219</sup> USGCRP, 2016: *The Impacts of Climate Change on Human Health in the United States: A Scientific Assessment*. Crimmins, A., J. Balbus, J.L. Gamble, C.B. Beard, J.E. Bell, D. Dodgen, R.J. Eisen, N. Fann, M.D. Hawkins, S.C. Herring, L. Jantarasami, D.M. Mills, S. Saha, M.C. Sarofim, J. Trtanj, and L. Ziska, Eds. U.S. Global Change Research Program, Washington, DC, 312 pp. <https://health2016.globalchange.gov/>.

<sup>1220</sup> Oppenheimer, M., M. Campos, R. Warren, J. Birkmann, G. Luber, B. O'Neill, and K. Takahashi, 2014: *Emergent risks and key vulnerabilities*. In: *Climate Change 2014: Impacts, Adaptation, and Vulnerability. Part A: Global and Sectoral Aspects. Contribution of Working Group II to the Fifth Assessment Report of the Intergovernmental Panel on Climate Change* [Field, C.B., V.R. Barros, D.J. Dokken, K.J. Mach, M.D. Mastrandrea, T.E. Bilir, M. Chatterjee, K.L. Ebi, Y.O. Estrada, R.C. Genova, B. Girma, E.S. Kissel, A.N. Levy, S. MacCracken, P.R. Mastrandrea, and L.L. White (eds.)]. Cambridge University Press, Cambridge, United Kingdom and New York, NY, USA, pp. 1039–1099.

<sup>1221</sup> Porter, J.R., L. Xie, A.J. Challinor, K. Cochran, S.M. Howden, M.M. Iqbal, D.B. Lobell, and M.I. Travasso, 2014: *Food security and food production systems*. In: *Climate Change 2014: Impacts, Adaptation, and Vulnerability. Part A: Global and Sectoral Aspects. Contribution of Working Group II to the Fifth Assessment Report of the Intergovernmental Panel on Climate Change* [Field, C.B., V.R. Barros, D.J. Dokken, K.J. Mach, M.D. Mastrandrea, T.E. Bilir, M. Chatterjee, K.L. Ebi, Y.O. Estrada, R.C. Genova, B. Girma, E.S. Kissel, A.N. Levy, S. MacCracken, P.R. Mastrandrea, and L.L. White (eds.)]. Cambridge University Press, Cambridge, United Kingdom and New York, NY, USA, pp. 485–533.

<sup>1222</sup> Smith, K.R., A. Woodward, D. Campbell-Lendrum, D.D. Chadee, Y. Honda, Q. Liu, J.M. Olwoch, B. Revich, and R. Sauerborn, 2014: Human health: impacts, adaptation, and co-benefits. In: *Climate Change 2014: Impacts, Adaptation, and Vulnerability. Part A: Global and Sectoral Aspects. Contribution of Working Group II to the Fifth Assessment Report of the Intergovernmental Panel on Climate Change* [Field, C.B., V.R. Barros, D.J. Dokken, K.J. Mach, M.D. Mastrandrea, T.E. Bilir, M. Chatterjee, K.L. Ebi, Y.O. Estrada, R.C. Genova, B. Girma, E.S. Kissel, A.N. Levy, S. MacCracken, P.R. Mastrandrea, and L.L. White (eds.)]. Cambridge University Press, Cambridge, United Kingdom and New York, NY, USA, pp. 709–754.

<sup>1223</sup> IPCC, 2018: Global Warming of 1.5°C. An IPCC Special Report on the impacts of global warming of 1.5°C above pre-industrial levels and related global greenhouse gas emission pathways, in the context of strengthening the global response to the threat of climate change, sustainable development, and efforts to eradicate poverty [Masson-Delmotte, V., P. Zhai, H.-O. Pörtner, D. Roberts, J. Skea, P.R. Shukla, A. Pirani, W. Moufouma-Okia, C. Péan, R. Pidcock, S. Connors, J.B.R. Matthews, Y. Chen, X. Zhou, M.I. Gomis, E. Lonnoy, T. Maycock, M. Tignor, and T. Waterfield (eds.)]. In Press.

<sup>1214</sup> Current Asthma Prevalence by Race and Ethnicity (2018–2020). [Online at [https://www.cdc.gov/asthma/most\\_recent\\_national\\_asthma\\_data.html](https://www.cdc.gov/asthma/most_recent_national_asthma_data.html)].

<sup>1215</sup> Arias, E. Xu, J. (2022) United States Life Tables, 2019. National Vital Statistics Report, Volume 70, Number 19. [Online at <https://www.cdc.gov/nchs/data/nvsr/nvsr70/nvsr70-19.pdf>].

<sup>1216</sup> USGCRP, 2018: Impacts, Risks, and Adaptation in the United States: Fourth National Climate Assessment, Volume II [Reidmiller, D.R., C.W. Avery, D.R. Easterling, K.E. Kunkel, K.L.M. Lewis, T.K. Maycock, and B.C. Stewart (eds.)]. U.S. Global Change Research Program, Washington, DC, USA, 1515 pp. doi:10.7930/NCA4.2018.

<sup>1217</sup> Demetillo, M.A.; Harkins, C.; McDonald, B.C.; et al. (2021) Space-based observational constraints on NO<sub>2</sub> air pollution inequality from diesel traffic in major US cities. *Geophys Res Lett* 48, e2021GL094333.



Medicine,<sup>1224</sup> and the EPA<sup>1226</sup> add more evidence that the impacts of climate change raise potential EJ concerns. These reports conclude that less-affluent, traditionally marginalized and predominantly non-White communities can be especially vulnerable to climate change impacts because they tend to have limited resources for adaptation, are more dependent on climate-sensitive resources such as local water and food supplies or have less access to social and information resources. Some communities of color, specifically populations defined jointly by ethnic/racial characteristics and geographic location (e.g., African-American, Black, and Hispanic/Latino communities; Native Americans, particularly those living on tribal lands and Alaska Natives), may be uniquely vulnerable to climate change health impacts in the U.S., as discussed in this section. In particular, the 2016 scientific assessment on the *Impacts of Climate Change on Human Health*<sup>1227</sup> found with high confidence that vulnerabilities are place- and time-specific, lifestages and ages are linked to immediate and future health impacts, and social determinants of health are linked to greater extent and severity of climate change-related health impacts. The GHG emission reductions from this final rule would contribute to efforts to reduce the probability of severe impacts related to climate change.

i. Effects on Specific Communities and Populations

Per the Fourth National Climate Assessment (NCA4), “Climate change affects human health by altering exposures to heat waves, floods, droughts, and other extreme events; vector-, food- and waterborne infectious diseases; changes in the quality and safety of air, food, and water; and stresses to mental health and well-being.”<sup>1228</sup> Many health conditions

such as cardiopulmonary or respiratory illness and other health impacts are associated with and exacerbated by an increase in GHGs and climate change outcomes, which is problematic as these diseases occur at higher rates within vulnerable communities. Importantly, negative public health outcomes include those that are physical in nature, as well as mental, emotional, social, and economic.

The scientific assessment literature, including the aforementioned reports, demonstrates that there are myriad ways in which particular communities and populations may be affected at the individual and community levels. Individuals face differential exposure to criteria pollutants, in part due to the proximities of highways, trains, factories, and other major sources of pollutant-emitting sources to less-affluent residential areas. Outdoor workers, such as construction or utility crews and agricultural laborers, who frequently are comprised of already at-risk groups, are exposed to poor air quality and extreme temperatures without relief. Furthermore, people in communities with EJ concerns face greater housing, clean water, and food insecurity and bear disproportionate and adverse economic impacts and health burdens associated with climate change effects. They have less or limited access to healthcare and affordable, adequate health or homeowner insurance.<sup>1229</sup> Finally, resiliency and adaptation are more difficult for economically vulnerable communities; these communities have less liquidity, individually and collectively, to move or to make the types of infrastructure or policy changes to limit or reduce the hazards they face. They frequently are less able to self-advocate for resources that would otherwise aid in building resilience and hazard reduction and mitigation.

The assessment literature cited in EPA’s 2009 and 2016 Endangerment and Cause or Contribute Findings, as well as *Impacts of Climate Change on Human Health*, also concluded that certain populations and life stages, including children, are most vulnerable to climate-related health effects.<sup>1230</sup> The assessment literature produced from 2016 to the present strengthens these

conclusions by providing more detailed findings regarding related vulnerabilities and the projected impacts youth may experience. These assessments—including the NCA4 and *The Impacts of Climate Change on Human Health in the United States* (2016)—describe how children’s unique physiological and developmental factors contribute to making them particularly vulnerable to climate change. Impacts to children are expected from heat waves, air pollution, infectious and waterborne illnesses, and mental health effects resulting from extreme weather events. In addition, children are among those especially susceptible to allergens, as well as health effects associated with heat waves, storms, and floods. Additional health concerns may arise in low-income households, especially those with children, if climate change reduces food availability and increases prices, leading to food insecurity within households. More generally, these reports note that extreme weather and flooding can cause or exacerbate poor health outcomes by affecting mental health because of stress; contributing to or worsening existing conditions, again due to stress or also as a consequence of exposures to water and air pollutants; or by impacting hospital and emergency services operations.<sup>1231</sup> Further, in urban areas in particular, flooding can have significant economic consequences due to effects on infrastructure, pollutant exposures, and drowning dangers. The ability to withstand and recover from flooding is dependent in part on the social vulnerability of the affected population and individuals experiencing an event.<sup>1232</sup> In addition, children are among those especially susceptible to allergens, as well as health effects associated with heat waves, storms, and floods. Additional health concerns may arise in low-income households, especially those with children, if climate change reduces food availability and increases prices, leading to food insecurity within households.

<sup>1224</sup> National Research Council. 2011. *America’s Climate Choices*. Washington, DC: The National Academies Press. <https://doi.org/10.17226/12781>.

<sup>1225</sup> National Academies of Sciences, Engineering, and Medicine. 2017. *Communities in Action: Pathways to Health Equity*. Washington, DC: The National Academies Press. <https://doi.org/10.17226/24624>.

<sup>1226</sup> EPA. 2021. *Climate Change and Social Vulnerability in the United States: A Focus on Six Impacts*. U.S. Environmental Protection Agency, EPA 430-R-21-003.

<sup>1227</sup> USGCRP, 2016: *The Impacts of Climate Change on Human Health in the United States: A Scientific Assessment*.

<sup>1228</sup> Ebi, K.L., J.M. Balbus, G. Luber, A. Bole, A. Crimmins, G. Glass, S. Saha, M.M. Shimamoto, J. Trtanj, and J.L. White-Newsome, 2018: Human Health. In *Impacts, Risks, and Adaptation in the United States: Fourth National Climate Assessment*,

Volume II [Reidmiller, D.R., C.W. Avery, D.R. Easterling, K.E. Kunkel, K.L.M. Lewis, T.K. Maycock, and B.C. Stewart (eds.)]. U.S. Global Change Research Program. Washington, DC, USA, pp. 539–571. doi: 10.7930/NCA4.2018.CH14.

<sup>1229</sup> USGCRP, 2016: *The Impacts of Climate Change on Human Health in the United States: A Scientific Assessment*.

<sup>1230</sup> 74 FR 66496, December 15, 2009; 81 FR 54422, August 15, 2016.

<sup>1231</sup> Ebi, K.L., J.M. Balbus, G. Luber, A. Bole, A. Crimmins, G. Glass, S. Saha, M.M. Shimamoto, J. Trtanj, and J.L. White-Newsome, 2018: Human Health. In *Impacts, Risks, and Adaptation in the United States: Fourth National Climate Assessment*, Volume II [Reidmiller, D.R., C.W. Avery, D.R. Easterling, K.E. Kunkel, K.L.M. Lewis, T.K. Maycock, and B.C. Stewart (eds.)]. U.S. Global Change Research Program, Washington, DC, USA, pp. 539–571. doi:10.7930/NCA4.2018.CH14.

<sup>1232</sup> National Academies of Sciences, Engineering, and Medicine 2019. *Framing the Challenge of Urban Flooding in the United States*. Washington, DC: The National Academies Press. <https://doi.org/10.17226/25381>.

*The Impacts of Climate Change on Human Health*<sup>1233</sup> also found that some communities of color, low-income groups, people with limited English proficiency, and certain immigrant groups (especially those who are undocumented) are subject to many factors that contribute to vulnerability to the health impacts of climate change. While difficult to isolate from related socioeconomic factors, race appears to be an important factor in vulnerability to climate-related stress, with elevated risks for mortality from high temperatures reported for Black or African American individuals compared to White individuals after controlling for factors such as air conditioning use. Moreover, people of color are disproportionately more exposed to air pollution based on where they live, and disproportionately vulnerable due to higher baseline prevalence of underlying diseases such as asthma. As explained earlier, climate change can exacerbate local air pollution conditions so this increase in air pollution is expected to have disproportionate and adverse effects on these communities. Locations with greater health threats include urban areas (due to, among other factors, the “heat island” effect where built infrastructure and lack of green spaces increases local temperatures), areas where airborne allergens and other air pollutants already occur at higher levels, and communities experienced depleted water supplies or vulnerable energy and transportation infrastructure.

The recent EPA report on climate change and social vulnerability<sup>1234</sup> examined four socially vulnerable groups (individuals who are low income, minority, without high school diplomas, and/or 65 years and older) and their exposure to several different climate impacts (air quality, coastal flooding, extreme temperatures, and inland flooding). This report found that Black and African-American individuals were 40 percent more likely to currently live in areas with the highest projected increases in mortality rates due to climate-driven changes in extreme temperatures, and 34 percent more likely to live in areas with the highest

projected increases in childhood asthma diagnoses due to climate-driven changes in particulate air pollution. The report found that Hispanic and Latino individuals are 43 percent more likely to live in areas with the highest projected labor hour losses in weather-exposed industries due to climate-driven warming, and 50 percent more likely to live in coastal areas with the highest projected increases in traffic delays due to increases in high-tide flooding. The report found that American Indian and Alaska Native individuals are 48 percent more likely to live in areas where the highest percentage of land is projected to be inundated due to sea level rise, and 37 percent more likely to live in areas with high projected labor hour losses. Asian individuals were found to be 23 percent more likely to live in coastal areas with projected increases in traffic delays from high-tide flooding. Persons with low income or no high school diploma are about 25 percent more likely to live in areas with high projected losses of labor hours, and 15 percent more likely to live in areas with the highest projected increases in asthma due to climate-driven increases in particulate air pollution, and in areas with high projected inundation due to sea level rise.

In a more recent 2023 report, *Climate Change Impacts on Children’s Health and Well-Being in the U.S.*, the EPA considered the degree to which children’s health and well-being may be impacted by five climate-related environmental hazards—extreme heat, poor air quality, changes in seasonality, flooding, and different types of infectious diseases.<sup>1235</sup> The report found that children’s academic achievement is projected to be reduced by 4–7 percent per child, as a result of moderate and higher levels of warming, impacting future income levels. The report also projects increases in the numbers of annual emergency department visits associated with asthma, and that the number of new asthma diagnoses increases by 4–11 percent due to climate-driven increases in air pollution relative to current levels. In addition, more than 1 million children in coastal regions are projected to be temporarily displaced from their homes annually due to climate-driven flooding, and infectious disease rates are similarly anticipated to rise, with the number of new Lyme disease cases in children living in 22 states in the eastern and midwestern U.S. increasing

by approximately 3,000–23,000 per year compared to current levels. Overall, the report confirmed findings of broader climate science assessments that children are uniquely vulnerable to climate-related impacts and that in many situations, children in the U.S. who identify as Black, Indigenous, and People of Color, are limited English-speaking, do not have health insurance, or live in low-income communities may be disproportionately more exposed to the most severe adverse impacts of climate change.

Tribes and Indigenous communities face disproportionate and adverse risks from the impacts of climate change, particularly those communities impacted by degradation of natural and cultural resources within established reservation boundaries and threats to traditional subsistence lifestyles. Indigenous communities whose health, economic well-being, and cultural traditions depend upon the natural environment will likely be affected by the degradation of ecosystem goods and services associated with climate change. The IPCC indicates that losses of customs and historical knowledge may cause communities to be less resilient or adaptable.<sup>1236</sup> The NCA4 noted that while Tribes and Indigenous Peoples are diverse and will be impacted by the climate changes universal to all Americans, there are several ways in which climate change uniquely threatens Tribes and Indigenous Peoples’ livelihoods and economies.<sup>1237</sup> In addition, as noted in the following paragraph, there can be institutional barriers (including policy-based limitations and restrictions) to their management of water, land, and other natural resources that could impede adaptive measures.

For example, Indigenous agriculture in the Southwest is already being adversely affected by changing patterns of flooding, drought, dust storms, and rising temperatures leading to increased soil erosion, irrigation water demand, and decreased crop quality and herd sizes. The Confederated Tribes of the Umatilla Indian Reservation in the Northwest have identified climate risks to salmon, elk, deer, roots, and

<sup>1233</sup> USGCRP, 2016: The Impacts of Climate Change on Human Health in the United States: A Scientific Assessment. Crimmins, A., J. Balbus, J.L. Gamble, C.B. Beard, J.E. Bell, D. Dodgen, R.J. Eisen, N. Fann, M.D. Hawkins, S.C. Herring, L. Jantarasami, D.M. Mills, S. Saha, M.C. Sarofim, J. Trtanj, and L. Ziska, Eds. U.S. Global Change Research Program, Washington, DC, 312 pp. <http://dx.doi.org/10.7930/JOR49NXX>.

<sup>1234</sup> EPA. 2021. Climate Change and Social Vulnerability in the United States: A Focus on Six Impacts. U.S. Environmental Protection Agency, EPA 430-R-21-003.

<sup>1235</sup> EPA. 2023. Climate Change Impacts on Children’s Health and Well-Being in the U.S., EPA-430-R-23-001.

<sup>1236</sup> Porter, et al., 2014: Food security and food production systems.

<sup>1237</sup> Jantarasami, L.C., R. Novak, R. Delgado, E. Marino, S. McNeely, C. Narducci, J. Raymond-Yakoubian, L. Singletary, and K. Powys Whyte, 2018: Tribes and Indigenous Peoples. In *Impacts, Risks, and Adaptation in the United States: Fourth National Climate Assessment, Volume II* [Reidmiller, D.R., C.W. Avery, D.R. Easterling, K.E. Kunkel, K.L.M. Lewis, T.K. Maycock, and B.C. Stewart (eds.)]. U.S. Global Change Research Program, Washington, DC, USA, pp. 572–603. doi:10.7930/NCA4. 2018. CH15.

huckleberry habitat. Housing and sanitary water supply infrastructure are vulnerable to disruption from extreme precipitation events. Additionally, NCA4 noted that Tribes and Indigenous Peoples generally experience poor infrastructure, diminished access to quality healthcare, and greater risk of exposure to pollutants. Consequently, Native Americans often have disproportionately higher rates of asthma, cardiovascular disease, Alzheimer's disease, diabetes, and obesity. These health conditions and related effects (disorientation, heightened exposure to PM<sub>2.5</sub>, etc.) can all contribute to increased vulnerability to climate-driven extreme heat and air pollution events, which also may be exacerbated by stressful situations, such as extreme weather events, wildfires, and other circumstances.

NCA4 and IPCC's Fifth Assessment Report<sup>1238</sup> also highlighted several impacts specific to Alaskan Indigenous Peoples. Coastal erosion and permafrost thaw will lead to more coastal erosion, rendering winter travel riskier and exacerbating damage to buildings, roads, and other infrastructure—impacts on archaeological sites, structures, and objects that will lead to a loss of cultural heritage for Alaska's Indigenous people. In terms of food security, the NCA4 discussed reductions in suitable ice conditions for hunting, warmer temperatures impairing the use of traditional ice cellars for food storage, and declining shellfish populations due to warming and acidification. While the NCA4 also noted that climate change provided more opportunity to hunt from boats later in the fall season or earlier in the spring, the assessment found that the net impact was an overall decrease in food security. In addition, the U.S. Pacific Islands and the Indigenous communities that live there are also uniquely vulnerable to the effects of climate change due to their remote location and geographic isolation. They rely on the land, ocean, and natural resources for their livelihoods, but they face challenges in obtaining energy and food supplies that need to be shipped in at high costs. As a result, they face higher energy costs than the rest of the nation and depend on imported fossil fuels for electricity generation and diesel. These challenges exacerbate the climate impacts that the Pacific Islands are experiencing. NCA4 notes that Tribes and Indigenous Peoples of the Pacific are threatened by rising sea levels, diminishing freshwater availability, and negative effects to

ecosystem services that threaten these individuals' health and well-being.

### 3. Non-GHG Impacts

In section V.B., in addition to GHG emissions impacts, we also discuss potential additional emission changes of non-GHGs (*i.e.*, criteria and air toxic pollutants) that we project from compliance with the final GHG emission standards. This section VI.D.3 describes evidence that communities with EJ concerns are disproportionately and adversely impacted by relevant non-GHG emissions. We discuss the potential impact of non-GHG emissions for two specific contexts: near-roadway (section VI.D.3.i) and upstream sources (section VI.D.3.ii).

#### i. Near-Roadway Analysis

As described in section VI.B.2.viii of this preamble, concentrations of many air pollutants are elevated near high-traffic roadways. We recently conducted an analysis of the populations within the CONUS living in close proximity to truck freight routes as identified in USDOT's FAF4.<sup>1239</sup> FAF4 is a model from the USDOT's Bureau of Transportation Statistics and Federal Highway Administration, which provides data associated with freight movement in the United States.<sup>1240</sup> Relative to the rest of the population, people living near FAF4 truck routes are more likely to be people of color and have lower incomes than the general population. People living near FAF4 truck routes are also more likely to live in metropolitan areas. Even controlling for region of the country, county characteristics, population density, and household structure, race, ethnicity, and income are significant determinants of whether someone lives near a FAF4 truck route.

We additionally analyzed other national databases that allowed us to evaluate whether homes and schools were located near a major road and whether disparities in exposure may be occurring in these environments. Until 2009, the U.S. Census Bureau's American Housing Survey (AHS) included descriptive statistics of over

70,000 housing units across the nation and asked about transportation infrastructure near respondents' homes every two years.<sup>1241</sup> <sup>1242</sup> We also analyzed the U.S. Department of Education's Common Core of Data, which includes enrollment and location information for schools across the United States.<sup>1243</sup>

In analyzing the 2009 AHS, we focused on whether a housing unit was located within 300 feet of a "4-or-more lane highway, railroad, or airport" (this distance was used in the AHS analysis).<sup>1244</sup> We analyzed whether there were differences between households in such locations compared with those in locations farther from these transportation facilities.<sup>1245</sup> We included other variables, such as land use category, region of country, and housing type. We found that homes with a non-White householder were 22–34 percent more likely to be located within 300 feet of these large transportation facilities than homes with White householders. Homes with a Hispanic householder were 17–33 percent more likely to be located within 300 feet of these large transportation facilities than homes with non-Hispanic householders. Households near large transportation facilities were, on average, lower in income and educational attainment and more likely to be a rental property and located in an urban area compared with households more distant from transportation facilities.

In examining schools near major roadways, we used the Common Core of Data from the U.S. Department of Education, which includes information on all public elementary and secondary schools and school districts nationwide.<sup>1246</sup> To determine school

<sup>1241</sup> U.S. Department of Housing and Urban Development, & U.S. Census Bureau. (n.d.). Age of other residential buildings within 300 feet. In American Housing Survey for the United States: 2009 (pp. A–1). Retrieved from <https://www.census.gov/programs-surveys/ahs/data/2009/ahs-2009-summary-tables0/h150-09.html>.

<sup>1242</sup> The 2013 AHS again included the "etrans" question about highways, airports, and railroads within half a block of the housing unit but has not maintained the question since then.

<sup>1243</sup> <http://nces.ed.gov/ccd/>.

<sup>1244</sup> This variable primarily represents roadway proximity. According to the Central Intelligence Agency's World Factbook, in 2010, the United States had 6,506,204 km of roadways, 224,792 km of railways, and 15,079 airports. Highways thus represent the overwhelming majority of transportation facilities described by this factor in the AHS.

<sup>1245</sup> Bailey, C. (2011) Demographic and Social Patterns in Housing Units Near Large Highways and other Transportation Sources. Memorandum to docket.

<sup>1246</sup> <http://nces.ed.gov/ccd/>.

<sup>1238</sup> Porter, *et al.*, 2014: Food security and food production systems.

<sup>1239</sup> U.S. EPA (2021). Estimation of Population Size and Demographic Characteristics among People Living Near Truck Routes in the Conterminous United States. Memorandum to the Docket.

<sup>1240</sup> FAF4 includes data from the 2012 Commodity Flow Survey (CFS), the Census Bureau on international trade, as well as data associated with construction, agriculture, utilities, warehouses, and other industries. FAF4 estimates the modal choices for moving goods by trucks, trains, boats, and other types of freight modes. It includes traffic assignments, including truck flows on a network of truck routes. [https://ops.fhwa.dot.gov/freight/freight\\_analysis/faf/](https://ops.fhwa.dot.gov/freight/freight_analysis/faf/).

proximities to major roadways, we used a geographic information system to map each school and roadways based on the U.S. Census's TIGER roadway file.<sup>1247</sup> We estimated that about 10 million students attend schools within 200 meters of major roads, about 20 percent of the total number of public school students in the United States.<sup>1248</sup> About 800,000 students attend public schools within 200 meters of primary roads, or about 2 percent of the total. We found that students of color were overrepresented at schools within 200 meters of primary roadways, and schools within 200 meters of primary roadways had a disproportionately greater population of students eligible for free or reduced-price lunches.<sup>1249</sup> Black students represent 22 percent of students at schools located within 200 meters of a primary road, compared to 17 percent of students in all U.S. schools. Hispanic students represent 30 percent of students at schools located within 200 meters of a primary road, compared to 22 percent of students in all U.S. schools.

We also reviewed existing scholarly literature examining the potential for disproportionately high exposure to

these pollutants among people of color and people with low socioeconomic status (SES). Numerous studies evaluating the demographics and socioeconomic status of populations or schools near roadways have found that they include a greater percentage of residents of color, as well as lower SES populations (as indicated by variables such as median household income). Locations in these studies include Los Angeles, CA; Seattle, WA; Wayne County, MI; Orange County, FL; Tampa, FL; the State of California; the State of Texas; and nationally.<sup>1250</sup> Such disparities may be due to multiple

factors, such as historic segregation, redlining, residential mobility, and daily mobility.<sup>1262</sup>

Several publications report nationwide analyses that compare the demographic patterns of people who do or do not live near major roadways.<sup>1268</sup> Three of these studies found that people living near major roadways are more likely to be people of color or of low SES.<sup>1274</sup> They also found that the outcomes of their analyses varied between regions within the United States. However, only one such study looked at whether such conclusions were confounded by living in a location with higher population density and looked at how demographics differ between locations nationwide.<sup>1277</sup> That study generally found that higher density areas have higher proportions of low-income residents and people of color. In other publications assessing a city, county, or state, the results are similar.<sup>1278</sup>

<sup>1247</sup> Pedde, M.; Bailey, C. (2011) Identification of Schools within 200 Meters of U.S. Primary and Secondary Roads. Memorandum to the docket.

<sup>1248</sup> Here, "major roads" refer to those TIGER classifies as either "Primary" or "Secondary". The Census Bureau describes primary roads as "generally divided limited-access highways within the Federal interstate system or under state management". Secondary roads are "main arteries, usually in the U.S. highway, state highway, or county highway system".

<sup>1249</sup> For this analysis we analyzed a 200-meter distance based on the understanding that roadways generally influence air quality within a few hundred meters from the vicinity of heavily traveled roadways or along corridors with significant trucking traffic. See U.S. EPA, 2014. Near Roadway Air Pollution and Health: Frequently Asked Questions. EPA-420-F-14-044.

<sup>1250</sup> Marshall, J.D. (2008) Environmental inequality: air pollution exposures in California's South Coast Air Basin. *Atmos Environ* 42: 5499-5503. doi:10.1016/j.atmosenv.2008.02.00.

<sup>1251</sup> Su, J.G.; Larson, T.; Gould, T.; Cohen, M.; Buzzelli, M. (2010) Transboundary air pollution and environmental justice: Vancouver and Seattle compared. *GeoJournal* 57: 595-608. doi:10.1007/s10708-009-9269-6.

<sup>1252</sup> Chakraborty, J.; Zandbergen, P.A. (2007) Children at risk: measuring racial/ethnic disparities in potential exposure to air pollution at school and home. *J Epidemiol Community Health* 61: 1074-1079. doi:10.1136/jech.2006.054130.

<sup>1253</sup> Green, R.S.; Smorodinsky, S.; Kim, J.J.; McLaughlin, R.; Ostro, B. (2004) Proximity of California public schools to busy roads. *Environ Health Perspect* 112: 61-66. doi:10.1289/ehp.6566.

<sup>1254</sup> Wu, Y.; Batterman, S.A. (2006) Proximity of schools in Detroit, Michigan to automobile and truck traffic. *J Exposure Sci & Environ Epidemiol*. doi:10.1038/sj.jes.7500484.

<sup>1255</sup> Su, J.G.; Jerrett, M.; de Nazelle, A.; Wolch, J. (2011) Does exposure to air pollution in urban parks have socioeconomic, racial, or ethnic gradients? *Environ Res* 111: 319-328.

<sup>1256</sup> Jones, M.R.; Diez-Roux, A.; Hajat, A.; et al. (2014) Race/ethnicity, residential segregation, and exposure to ambient air pollution: The Multi-Ethnic Study of Atherosclerosis (MESA). *Am J Public Health* 104: 2130-2137. [Online at: <https://doi.org/10.2105/AJPH.2014.302135>].

<sup>1257</sup> Stuart A.L., Zeager M. (2011) An inequality study of ambient nitrogen dioxide and traffic levels near elementary schools in the Tampa area. *Journal of Environmental Management*. 92(8): 1923-1930. <https://doi.org/10.1016/j.jenvman.2011.03.003>.

<sup>1258</sup> Stuart A.L., Mudhasakul S., Sriwatanapongse W. (2009) The Social Distribution of Neighborhood-Scale Air Pollution and Monitoring Protection. *Journal of the Air & Waste Management Association*. 59(5): 591-602. <https://doi.org/10.3155/1047-3289.59.5.591>.

<sup>1259</sup> Willis M.D., Hill E.L., Kile M.L., Carozza S., Hystad P. (2020) Assessing the effectiveness of vehicle emission regulations on improving perinatal health: a population-based accountability study. *International Journal of Epidemiology*. 49(6): 1781-1791. <https://doi.org/10.1093/ije/dyaa137>.

<sup>1260</sup> Collins, T.W., Grineski, S.E., Nadybal, S. (2019) Social disparities in exposure to noise at public schools in the contiguous United States. *Environ. Res.* 175, 257-265. <https://doi.org/10.1016/j.envres.2019.05.024>.

<sup>1261</sup> Kingsley S., Eliot M., Carlson L., Finn J., MacIntosh D.L., Suh H.H., Wellenius G.A. (2014) Proximity of US schools to major roadways: a nationwide assessment. *J Expo Sci Environ Epidemiol*. 24: 253-259. <https://doi.org/10.1038/jes.2014.5>.

<sup>1262</sup> Depro, B.; Timmins, C. (2008) Mobility and environmental equity: do housing choices determine exposure to air pollution? Duke University Working Paper.

<sup>1263</sup> Rothstein, R. *The Color of Law: A Forgotten History of How Our Government Segregated America*. New York: Liveright, 2018.

<sup>1264</sup> Lane, H.J.; Morello-Frosch, R.; Marshall, J.D.; Apte, J.S. (2022) Historical redlining is associated with present-day air pollution disparities in US Cities. *Environ Sci & Technol* 9: 345-350. DOI: [Online at: <https://doi.org/10.1021/acs.estlett.1c01012>].

<sup>1265</sup> Ware, L. (2021) Plessy's legacy: the government's role in the development and perpetuation of segregated neighborhoods. *RSF: The Russell Sage Foundation Journal of the Social Sciences*, 7:92-109. DOI: 10.7758/RSF.2021.7.1.06.

<sup>1266</sup> Archer, D.N. (2020) "White Men's Roads through Black Men's Homes": advancing racial equity through highway reconstruction. *Vanderbilt Law Rev* 73: 1259.

<sup>1267</sup> Park, Y.M.; Kwan, M.P. (2020) Understanding Racial Disparities in Exposure to Traffic-Related Air Pollution: Considering the Spatiotemporal Dynamics of Population Distribution. *Int. J. Environ. Res. Public Health*. 17 (3): 908. <https://doi.org/10.3390/ijerph17030908>.

<sup>1268</sup> Rowangould, G.M. (2013) A census of the U.S. near-roadway population: public health and environmental justice considerations. *Transportation Research Part D*; 59-67.

<sup>1269</sup> Tian, N.; Xue, J.; Barzyk, T.M. (2013) Evaluating socioeconomic and racial differences in traffic-related metrics in the United States using a GIS approach. *J Exposure Sci Environ Epidemiol* 23: 215-222.

<sup>1270</sup> CDC (2013) Residential proximity to major highways—United States, 2010. *Morbidity and Mortality Weekly Report* 62(3): 46-50.

<sup>1271</sup> Clark, L.P.; Millet, D.B., Marshall, J.D. (2017) Changes in transportation-related air pollution exposures by race-ethnicity and socioeconomic status: outdoor nitrogen dioxide in the United States in 2000 and 2010. *Environ Health Perspect* <https://doi.org/10.1289/EHP959>.

<sup>1272</sup> Mikati, I.; Benson, A.F.; Luben, T.J.; Sacks, J.D.; Richmond-Bryant, J. (2018) Disparities in distribution of particulate matter emission sources by race and poverty status. *Am J Pub Health* <https://ajph.aphapublications.org/doi/abs/10.2105/AJPH.2017.304297?journalCode=ajph>.

<sup>1273</sup> Alotaibi, R.; Bechle, M.; Marshall, J.D.; Ramani, T.; Zietsman, J.; Nieuwenhuijsen, M.J.; Khreis, H. (2019) Traffic related air pollution and the burden of childhood asthma in the continuous United States in 2000 and 2010. *Environ International* 127: 858-867. <https://www.sciencedirect.com/science/article/pii/S0160412018325388>.

<sup>1274</sup> Tian, N.; Xue, J.; Barzyk, T.M. (2013) Evaluating socioeconomic and racial differences in traffic-related metrics in the United States using a GIS approach. *J Exposure Sci Environ Epidemiol* 23: 215-222.

<sup>1275</sup> Rowangould, G.M. (2013) A census of the U.S. near-roadway population: public health and environmental justice considerations. *Transportation Research Part D*; 59-67.

<sup>1276</sup> CDC (2013) Residential proximity to major highways—United States, 2010. *Morbidity and Mortality Weekly Report* 62(3): 46-50.

<sup>1277</sup> Rowangould, G.M. (2013) A census of the U.S. near-roadway population: public health and environmental justice considerations. *Transportation Research Part D*; 59-67.

<sup>1278</sup> Pratt, G.C.; Vadali, M.L.; Kvale, D.L.; Ellickson, K.M. (2015) Traffic, air pollution, minority, and socio-economic status: addressing inequities in exposure and risk. *Int J Environ Res*

Furthermore, students of lower-income families and students with disabilities are more likely to travel to school by bus or public transit than are other students.<sup>1281 1282 1283</sup>

Two recent studies provide strong evidence that reducing emissions from heavy-duty vehicles is likely to reduce the disparity in exposures to traffic-related air pollutants. Both use NO<sub>2</sub> observations from the recently launched TROPospheric Ozone Monitoring Instrument satellite sensor as a measure of air quality, which provides high-resolution observations that heretofore were unavailable from any satellite.<sup>1284</sup>

One study evaluated NO<sub>2</sub> concentrations during the COVID-19 lockdowns in 2020 and compared them to NO<sub>2</sub> concentrations from the same dates in 2019.<sup>1285</sup> That study found that average NO<sub>2</sub> concentrations were highest in areas with the lowest percentage of White populations, and that the areas with the greatest percentages of non-White or Hispanic populations experienced the greatest declines in NO<sub>2</sub> concentrations during the lockdown. These NO<sub>2</sub> reductions were associated with the density of highways in the local area.

In the second study, NO<sub>2</sub> measured from 2018–2020 was averaged by racial groups and income levels in 52 large U.S. cities. Using census tract-level NO<sub>2</sub>, the study reported average population-weighted NO<sub>2</sub> levels to be 28 percent higher for low-income non-White people compared with high-income White people. The study also used

weekday-weekend differences and bottom-up emission estimates to estimate that diesel traffic is the dominant source of NO<sub>2</sub> disparities in the studied cities.

Overall, there is substantial evidence that people who live or attend school near major roadways are more likely to be of a non-White race, Hispanic, and/or have a low SES. As described in section VI.B.2.viii, traffic-related air pollution may have disproportionate and adverse impacts on health across racial and sociodemographic groups. We expect communities near roads will benefit from the reduced vehicle emissions of PM, NO<sub>x</sub>, SO<sub>2</sub>, VOC, CO, and mobile source air toxics projected to result from this final rule. Although we were not able to conduct air quality modeling of the estimated emission reductions, we believe it a fair inference that because vehicular emissions affect communities with environmental justice concerns disproportionately and adversely due to roadway proximity, and because we project this rule will result in significant reductions in vehicular emissions, these communities' exposures to non-GHG air pollutants will be reduced. EPA is considering how to better estimate the near-roadway air quality impacts of its regulatory actions and how those impacts are distributed across populations.

#### ii. Upstream Source Impacts

As described in Chapter 4.5, we expect some non-GHG emissions reductions from sources related to refining petroleum fuels and increases in emissions from EGUs, both of which would lead to changes in exposure for people living in communities near these facilities. The EGU emissions increases become smaller over time because of changes in the projected power generation mix as electricity generation uses less fossil fuels.

Analyses of communities in close proximity to EGUs have found that a higher percentage of communities of color and low-income communities live near these sources when compared to national averages.<sup>1286</sup> EPA compared the percentages of people of color and low-income populations living within three miles of fossil fuel-fired power plants regulated under EPA's Acid Rain Program and/or EPA's Cross-State Air Pollution Rule to the national average and found that there is a greater percentage of people of color and low-income individuals living near these power plants than in the rest of the

country on average.<sup>1287</sup> According to 2020 Census data, on average, the U.S. population is comprised of 40 percent people of color and 30 percent low-income individuals. In contrast, the population living near fossil fuel-fired power plants is comprised of 53 percent people of color and 34 percent low-income individuals.<sup>1288</sup> Historically redlined neighborhoods are more likely to be downwind of fossil fuel power plants and to experience higher levels of exposure to relevant emissions than non-redlined neighborhoods.<sup>1289</sup> Analysis of populations near refineries and oil and gas wells indicates there may be potential disparities in pollution-related health risk from these sources.<sup>1290 1291 1292 1293</sup> See also section V.B of this preamble, discussing issues pertaining to lifecycle emissions more generally.

#### E. Economic Impacts

##### 1. Impacts on Vehicle Sales, Fleet Turnover, Mode Shift, Class Shift and Domestic Production

In this section, we discuss the impacts this regulation may have on HD vehicle sales, including the potential for pre-buy and low-buy decisions, decisions regarding the mode of transportation used to move goods, shifting of purchases between HD vehicle classes, and effects on domestic production of HD vehicles, under the modeled potential compliance pathway. Pre-buy occurs when a purchaser pulls ahead a planned future purchase to make the purchase before implementation of an EPA regulation in anticipation that a

Public Health 12: 5355–5372. <http://dx.doi.org/10.3390/ijerph120505355>.

<sup>1279</sup> Sohrabi, S.; Zietsman, J.; Khreis, H. (2020) Burden of disease assessment of ambient air pollution and premature mortality in urban areas: the role of socioeconomic status and transportation. *Int J Env Res Public Health* doi:10.3390/ijerph17041166.

<sup>1280</sup> Aizer A., Currie J. (2019) Lead and Juvenile Delinquency: New Evidence from Linked Birth, School, and Juvenile Detention Records. *The Review of Economics and Statistics*. 101 (4): 575–587. [https://doi.org/10.1162/rest\\_a\\_00814](https://doi.org/10.1162/rest_a_00814).

<sup>1281</sup> Bureau of Transportation Statistics (2021) The Longer Route to School. [Online at <https://www.bts.gov/topics/passenger-travel/back-school-2019>].

<sup>1282</sup> Wheeler, K.; Yang, Y.; Xiang, H. (2009) Transportation use patterns of U.S. children and teenagers with disabilities. *Disability and Health J* 2: 158–164. <https://doi.org/10.1016/j.dhjo.2009.03.003>.

<sup>1283</sup> Park, K.; Esfahani, H.N.; Novack, V.L.; et al. (2022) Impacts of disability on daily travel behaviour: A systematic review. *Transport Reviews* 43: 178–203. <https://doi.org/10.1080/01441647.2022.2060371>.

<sup>1284</sup> TROPospheric Ozone Monitoring Instrument (TROPOMI) is part of the Copernicus Sentinel-5 Precursor satellite.

<sup>1285</sup> Kerr, G.H.; Goldberg, D.L.; Anenberg, S.C. (2021) COVID-19 pandemic reveals persistent disparities in nitrogen dioxide pollution. *PNAS* 118. <https://doi.org/10.1073/pnas.2022409118>.

<sup>1286</sup> See 80 FR 64662, 64915–64916 (October 23, 2015).

<sup>1287</sup> U.S. EPA (2023) 2021 Power Sector Programs—Progress Report. <https://www3.epa.gov/airmarkets/progress/reports/>.

<sup>1288</sup> U.S. EPA (2023) 2021 Power Sector Programs—Progress Report. <https://www3.epa.gov/airmarkets/progress/reports/>.

<sup>1289</sup> Cushing L.J., Li S., Steiger B.B., Casey J.A. (2023) Historical red-lining is associated with fossil fuel power plant siting and present-day inequalities in air pollutant emissions. *Nature Energy*. 8: 52–61. <https://doi.org/10.1038/s41560-022-01162-y>.

<sup>1290</sup> U.S. EPA (2014). Risk and Technology Review—Analysis of Socio-Economic Factors for Populations Living Near Petroleum Refineries. Office of Air Quality Planning and Standards, Research Triangle Park, North Carolina. January.

<sup>1291</sup> Carpenter, A., and M. Wagner. Environmental justice in the oil refinery industry: A panel analysis across United States counties. *J. Ecol. Econ.* V. 159 (2019).

<sup>1292</sup> Gonzalez, J.X., et al. Historic redlining and the siting of oil and gas wells in the United States. *J. Exp. Sci. & Env. Epi.* V. 33. (2023). p. 76–83.

<sup>1293</sup> In comparison to the national population, the EPA publication reports higher proportions of the following population groups in block groups with higher cancer risk associated with emissions from refineries: “minority”, “African American”, “Other and Multiracial”, “Hispanic or Latino”, “Ages 0–17”, “Ages 18–64”, “Below the Poverty Level”, “Over 25 years old without a HS diploma”, and “Linguistic isolations”.

future vehicle may have a higher upfront or operational cost, or have reduced reliability. Low-buy occurs when a vehicle that would have been purchased after the implementation of a regulation is either not purchased at all, or the purchase is delayed. Low-buy may occur directly as a function of pre-buy (where a vehicle was instead purchased prior to implementation of the new regulation), or due to a vehicle purchaser delaying the purchase of a vehicle due to cost or uncertainty. Pre- and low-buy are short-term effects, with research indicating that effects are seen for one year or less before and after a regulation is implemented.<sup>1294</sup> Pre-buy and low-buy impact fleet turnover, which can result in a level of emission reduction attributable to the new emission standards that is different from the level of emission reduction EPA estimated. Mode shift occurs if goods that would normally be shipped by HD vehicle are instead shipped by another method (e.g., rail, boat, air) as a result of this action. Class shift occurs when a vehicle purchaser decides to purchase a different class of vehicle than originally intended due to the new regulation. For example, a purchaser may buy a Class 8 vehicle instead of the Class 7 vehicle they may have purchased in the absence of a regulation. Domestic production could be affected if the regulation creates incentives for manufacturers to shift between domestic and foreign production.

Based on our analysis of the comments and available data, as well as our technical expertise in implementing the HD GHG and other vehicle emissions programs, EPA finds that the above-described impacts are unlikely to occur in a significant manner. Specifically, we expect that they will either not occur at all, or if they do, occur in a limited way that will not significantly affect the GHG emissions reductions projected by this rule or that would unduly disrupt the HD vehicle market. Notably, while some commenters speculated about the possibility of these impacts, no commenter presented, and EPA is not aware of, actual data and analysis demonstrating that these impacts would occur in a significant way in response to this regulation. While there is some analysis on these phenomena more generally—for example on low-buy and pre-buy in response to earlier HD

regulations or in the light-duty (LD) sector—EPA finds that such analyses are not directly relevant to this regulation given relevant differences between the economic impacts of HD GHG and earlier HD criteria pollutant regulation, HD ICE and HD ZEV vehicles, and the HD and LD sectors. As such, extrapolation of these studies to this HD GHG regulation would not be technically sound. Moreover, as we explain in this section, salient features of our analysis of the modeled potential compliance pathway for this regulation—including the significant expected operating savings as well as the continuing availability of ICE vehicles in all HD vehicle segments—provide strong, qualitative evidence that these impacts are unlikely to be significant as a result of the final standards.

#### i. Vehicle Sales and Fleet Turnover

The final emission standards may lead to a change in the timing of planned vehicle purchases, phenomena known as “pre-buy” and “low-buy.” Pre-buy occurs when purchasers of HD vehicles pull their planned future vehicle purchase forward to the months before a regulation is implemented compared to when they otherwise would have purchased a new vehicle in the absence of the regulation. Pre-buy may occur due to expected cost increases of post-regulation vehicles, or in order to avoid perceived cost, quality, or other changes associated with new emission standards. Another reason pre-buy might occur is due to purchaser beliefs about the availability of their vehicle type of choice in the post-regulation market. For example, if purchasers think that they might not be able to get the HD ICE vehicle they want after the regulation is promulgated, they may pre-buy an ICE vehicle.<sup>1295</sup>

Our assessment, with respect to ZEV technologies included in our potential compliance pathway, is that the Federal vehicle and battery tax credits, and EVSE tax credits for those purchasers eligible for them, will mitigate possible pre-buy by reducing the perceived purchase price or lifetime operational cost difference of a new, post-rule ZEV compared to a new pre- or post-rule comparable ICE vehicle. We also expect that the final rule’s more gradual phase-in of more stringent standards compared to the proposal will mitigate possible pre-buy. In addition, as noted in section

D of the Executive Summary, the estimated fleet-average costs to manufacturers per-vehicle for this rule are less than those estimated for the HD GHG Phase 2 rule, which EPA found to be reasonable, and we do not have data (and no commenter presented data) showing a significant level of pre-buy in anticipation of Phase 2. As also noted in section D of the Executive Summary, HD ZEV purchasers’ incremental upfront costs (after the tax credits) are recovered through operational savings such that payback occurs between two and four years on average for vocational vehicles, after two years for short-haul tractors, and after five years on average for long-haul tractors. These operational cost savings, and therefore the payback of the higher upfront costs, will also mitigate pre-buy to the extent they are considered in the purchase decision. With respect to possible purchaser anxiety over being unable to purchase an ICE vehicle after promulgation of the regulation, we note that these final standards do not mandate the production or purchase of any particular vehicle, or the use of any particular technology in such vehicles. As described in section C of the Executive Summary and preamble section II, we model a potential compliance pathway to meet the standards with a diverse mix of ICE vehicle and ZEV technologies, as well as additional example potential compliance pathways to meet the standards that do not include increasing utilization of ZEV technologies. In addition, the phasing-in of the standards will allow ample time for purchasers to make decisions about their vehicle of choice, and the potential compliance pathway modeled for this rule reflects that the majority of vehicles will remain ICE vehicles, even in MY 2032.

While uncertainty about a new technology may trigger pre-buy as well, this could be mitigated by purchasers being educated on the new technology or increasing exposure to the new technology. For example, education on the benefits of ZEV ownership and operational characteristics (for example, reduced operational costs, decreased exposure to exhaust emissions and engine noise and smoother acceleration) and on charging and hydrogen refueling infrastructure technology and availability may lead to less uncertainty about each of these technologies.<sup>1296</sup> Our final standards may increase purchaser exposure to ZEV

<sup>1294</sup> See the EPA report “Analysis of Heavy-Duty Vehicle Sales Impacts Due to New Regulation” at [https://cfpub.epa.gov/si/public\\_pra\\_view.cfm?dirEntryID=349838&Lab=OTAQ](https://cfpub.epa.gov/si/public_pra_view.cfm?dirEntryID=349838&Lab=OTAQ) for a literature review and EPA analysis of pre-buy and low-buy due to HD regulations.

<sup>1295</sup> We note that the HD TRUCS model used in this rulemaking to analyze ZEV technologies matched performance capabilities of ZEVs to an existing ICE vehicle for each use case where the ZEV vehicle technologies are technologically feasible.

<sup>1296</sup> For more information on purchaser acceptance of HD ZEVs, see RIA Chapter 6.2. For more information on the charging and hydrogen refueling infrastructure analysis in this rule, see RIA Chapter 2.6.

technologies, as well as incentivize manufacturers and dealers to educate HD vehicle purchasers on ZEVs, including the benefits of ZEVs, thus accelerating the reduction of purchaser risk aversion. We also expect recent congressional actions to support ZEV infrastructure and supply chain, including the CHIPS Act, BIL and IRA, will reduce uncertainty surrounding ZEV ownership.<sup>1297</sup> We note again that the standards do not mandate the use of a specific technology.

In addition to pre-buy, there is the possibility of “low-buy” occurring in response to new regulation.<sup>1298</sup> In a low-buy scenario, sales of HD vehicles decrease in the months after a regulation becomes effective, compared to what would have happened in the absence of a regulation, due to purchasers either pre-buying or delaying a planned purchase. Low-buy may be directly attributable to pre-buy, where purchases originally planned for the months following the effective date of new emission standards are instead purchased in the months preceding the effective date of the new emission standards. Low-buy may also be attributable to purchasers delaying the planned purchase of a new vehicle due to the new emission standards, and may occur for reasons such as increased costs or uncertainty about the new vehicles. We expect low-buy, to the extent that it might occur, to be mitigated under the same circumstances described in this section for pre-buy.

As noted in section 19.4 of the RTC for this rule, some commenters on the proposed rule highlight the potential for this rule to lead to pre-buy, with one commenter asserting that EPA should finalize more incremental measures than those proposed in order to avoid dramatic increases in up-front vehicle costs and associated pre-buy. Another commenter stated that the cost of complying with the proposal will lead to a pre-buy, and an increase in demand for the previous model year, leading to

an increase in the cost of that earlier model year. Some commenters also stated that EPA’s approach of not estimating sales effects is inconsistent with both EPA’s light-duty rules, and the recently finalized HD2027 rule.

In response to the comment regarding more incremental measures than those proposed, we point to preamble section II.F, where we explain that the standards for MYs 2027–2031 in the final rule are not as stringent as those proposed as they include a slower phase-in. While we made this change for the reasons stated in section II of the preamble and not due to any concerns with pre-buy or low-buy, this nonetheless is responsive to the commenters’ request for a slower phase-in. In addition, in response to this commenter and the commenter on costs, the costs of complying with the rule are lower on average than those estimated in the proposed rule. Also, the estimated pathways of compliance with the rule are associated with reduced fueling costs for both the vehicles with ICE technologies, and with ZEVs. ZEVs are also expected to have lower maintenance and repair costs than comparable ICE vehicles. These cost savings will reduce the payback period of such technologies that may be used by manufacturers to comply with the rule. We expect that these cost savings will work toward mitigating possible pre-buy and increased demand for previous model year vehicles.

In response to commenters stating that the qualitative discussion in the proposed rule is inconsistent with our approach to sales effects in light-duty rules, as well as with the recently finalized HD2027 Low NOx final rule<sup>1299</sup> (HD2027 rule), we believe this rule is significantly different from those rules such that we cannot apply the same kinds of quantitative analyses. First, with respect to light-duty, the light-duty market is a very different market than the HD vehicle market, and purchase decisions are made differently. LD consumer behavior includes different considerations than a HD vehicle owner who purchases a vehicle to perform work (such as transport passengers, deliver concrete, or move freight). Therefore, the method of analyses for estimating sales effects in the LD market are not the same as those that should be used for effects in the HD market. Second, the costs of GHG-reducing technologies are more than offset through operating savings, unlike the technologies associated with the

HD2027 rule. Thus, we would expect sales effects of this rule to be significantly different from those associated with the HD2027 rule or other rules establishing standards to reduce criteria pollutants.

At proposal, we discussed the analysis of EPA regulations on four recent HD regulations, which suggested that the range of possible pre-buy and low-buy due to those rules includes no pre-buy or low-buy due to EPA rules.<sup>1300</sup> We also made it clear that, while it is instructive that the ERG report found little to no pre-buy or low-buy effects due to our HD rules, the approach to estimate a change in the sales of HD vehicles before and after the promulgation of a rule due to the cost of that rule (as was done in the ERG report) should not be used to estimate sales effects from this final rule because: (1) most of the statistically significant sales effects in the report were estimated using data from criteria pollutant rules, which are not appropriate for use in estimating effects from HD GHG rules because differences in how costs are incurred and benefits are accrued as a result of HD vehicle criteria pollutant regulations versus HD GHG regulations may lead to differences in how HD vehicle buyers react to a particular regulation;<sup>1301</sup> (2) there was relatively more uncertainty in the net estimated price change from the 2014 GHG rule than in the criteria pollutant rules because the performance-based GHG standards had many different compliance pathways which led to both capital cost increases as well as reductions in operating costs through fuel savings. As such, the cost of the regulation could vary greatly across firms and may have led to net cost savings. This likely variation in net costs of the rule led to greater uncertainty in the results of the report; (3) the approach outlined in the report was estimated only using HD ICE vehicle data (e.g., cost of compliance due to adding HD ICE engine technologies to a HD ICE engine) because that was all that was available at the time of promulgation of the rules.

<sup>1297</sup> The CHIPS Act is the Creating Helpful Incentives to Produce Semiconductors and Science Act and was signed into law on August 9, 2022. It is designed to strengthen supply chains, domestic manufacturing and national security. More information on how all of these Acts are expected to support opportunities for growth along the supply chain can be found in the January 2023 White House publication “Building a Clean Energy Economy: A Guidebook to the Inflation Reduction Act’s Investments in Clean Energy and Climate Action.” found online at <https://www.whitehouse.gov/wp-content/uploads/2022/12/Inflation-Reduction-Act-Guidebook.pdf>.

<sup>1298</sup> In comments, commenters referred to “no-buy” as opposed to low-buy, however the concept is the same: the potential that vehicles that would have been purchased after the new rule becomes effective will not be purchased for a length of time.

<sup>1299</sup> “Control of Air Pollution from New Motor Vehicles: Heavy-Duty Engine and Vehicle Standards” 88 FR 4296, January 24, 2023.

<sup>1300</sup> “Analysis of Heavy-Duty Vehicle Sales Impacts Due to New Regulation.” At [https://cfpub.epa.gov/si/si\\_public\\_preview.cfm?dirEntryID=349838&Lab=OTAQ](https://cfpub.epa.gov/si/si_public_preview.cfm?dirEntryID=349838&Lab=OTAQ).

<sup>1301</sup> For example, the 2014 rule (“Final Rule for Phase 1 Greenhouse House Emissions Standards and Fuel Efficiency Standards for Medium- and Heavy-Duty Engines and Vehicles” found at <https://www.epa.gov/regulations-emissions-vehicles-and-engines/final-rule-phase-1-greenhouse-gas-emissions-standards>) led to reductions in GHG emissions and had lower associated technology costs compared to the criteria pollutant rules, and compliance with the GHG regulation was associated with fuel savings.

The modeled potential compliance pathway for this rule includes ZEV technologies, which associated EVSE infrastructure, and the possible impacts of such are not represented in the results of the report. For these reasons, we are not using the method in the ERG report to estimate sales effects due to this rule. For more discussion on comments, and our response to comments, related to sales effect of this rule, see RTC section 19.4.

This rulemaking is expected to lead to reductions in emissions across the HD vehicle fleet (see section V of this preamble), though such reductions are expected to happen gradually as the HD fleet turns over. This is because the fraction of the total HD vehicle fleet that are new, compliant vehicles will initially be a small portion of the entire HD market. As more vehicles compliant with this rule are sold, and as older HD vehicles are retired, greater emission reductions are expected to accumulate. The emission reductions attributable to each HD segment that will be affected by this rule will depend on many factors, including the rate of purchase of compliant vehicles in each market segment over time and the proportion of those vehicles that utilize each of the mix of technologies under the compliance pathways manufacturers choose. In addition, if pre-buy or low-buy occurs as a result of this rulemaking, emission reductions will be smaller than anticipated. Under pre-buy conditions, fleets would, on average, be comprised of newer model year vehicles. Though these new vehicles are expected to have lower emissions than the vehicles they are replacing, emission reductions could still be lower than we estimate will be achieved as a result of the final emission standards. Under low-buy, we expect older, more polluting, HD vehicles to remain in use longer than they otherwise would in the absence of new regulation. If pre-buy is smaller than low-buy, to the extent both might occur, this would lead to a slower fleet turnover, at least in the short term.<sup>1302</sup> Conversely, if pre-buy is larger than low-buy, short-term fleet turnover would increase and fleets would, on average, be comprised of newer model year vehicles, and though emission reductions would be expected to be larger than under a scenario where low-buy exceeds pre-buy, emission reductions would still be lower than we estimate will be achieved as a result of

<sup>1302</sup> Fleet turnover refers to the pace at which new vehicles are purchased and older vehicles are retired. A slower fleet turnover means older vehicles are kept on the road longer, and the fleet is older on average. A faster fleet turnover means that the fleet is younger, on average.

the final emission standards. Under a situation where low-buy matches pre-buy, we would also expect lower emission reductions than estimated, and emission reductions would likely be somewhere between the two relative pre-buy/low-buy scenarios discussed in this paragraph. For more information on sales impacts, see Chapter 6.1.1 of the RIA.

Although, as commenters mentioned, the increased purchase price due to this rule could potentially lead to pre-buy and/or low-buy, pre- or low-buy is unlikely to occur in a significant manner. Specifically, we expect that they will either not occur at all, or if they do, occur in a limited way that will not significantly affect the GHG emissions reductions projected by this rule or that would unduly disrupt the HD vehicle market. This is due, in part, to the operating cost savings we estimate will be achieved in complying with this rule. For the modeled compliance pathway for this rule, that cost savings are expected to wholly offset the increased upfront purchase cost for ZEVs, which leads to payback periods of between two and five years. This is also supported by the analyses of previously promulgated EPA HD emission standards, which indicate that where pre-buy or low-buy has been seen, the magnitude of these phenomena has been small.<sup>1303</sup> Lastly, it should be noted that many studies estimating how large or expensive purchases are made, including that of HD vehicles, indicate purchase decisions are heavily influenced by macroeconomic factors unrelated to regulations, such as interest rates, economic activity, and the general state of the economy.<sup>1304</sup> For example, according to the Economic Research Division of the Federal Reserve, retail sales of heavy weight trucks sales fell dramatically between September of 2019 and May of 2020 (about 46 percent fewer sales), likely in great part due to the COVID-19 pandemic, and they rebounded through May of 2021 to be

<sup>1303</sup> For example, Lam and Bausell (2007), Rittenhouse and Zaragoza-Watkins (2018), and an unpublished report by Harrison and LeBel (2008). For EPA's summary on these studies, see the EPA peer review report "Analysis of Heavy-Duty Vehicle Sales Impacts Due to New Regulation." at [https://cfpub.epa.gov/si/si\\_public\\_pra\\_view.cfm?dirEntryID=349838&Lab=OTAQ](https://cfpub.epa.gov/si/si_public_pra_view.cfm?dirEntryID=349838&Lab=OTAQ), in the docket for this rule.

<sup>1304</sup> See the literature review found in the ERG report mentioned earlier in this section, "Analysis of Heavy-Duty Vehicle Sales Impacts Due to New Regulation." Found at [https://cfpub.epa.gov/si/si\\_public\\_pra\\_view.cfm?dirEntryID=349838&Lab=OTAQ](https://cfpub.epa.gov/si/si_public_pra_view.cfm?dirEntryID=349838&Lab=OTAQ) for more information.

only about 13 percent lower than in September of the previous year.<sup>1305</sup>

#### ii. Mode Shift

Mode shift would occur if goods normally shipped by HD vehicle are instead shipped by another method (e.g., rail, boat, air) as a result of this action. Whether shippers switch to a different mode of transportation for freight depends not only on the cost per mile of the shipment (i.e., freight rate), but also the value of the shipment, the speed of transport needed for shipment (for example, for non-durable goods), and the availability of supporting infrastructure (e.g., rail lines, highways, waterways). Shifting from HD vehicles to other modes of transportation may occur if the cost of shipping goods by HD vehicles increases relative to other modes of transport in cases where there is another mode of transport available that can meet the required timing. Though we are unable to estimate what effect this rule might have on shipping costs, in part because we are not able to estimate how a change in upfront vehicle costs affects shipping rates, or how much of a change in operational costs is passed through to the shipping rates, we do estimate that, under the potential compliance pathway projected for this rule, average net upfront costs are paid back in five years or less for the vehicle groups affected by this rule, and these vehicles are expected to experience reduced operational costs. Chapter 3.3 of the RIA and section IV.D of this preamble discuss the estimated decrease in operational costs of this rule, mainly due to the increase in the share of ZEVs in the on-road HD fleet under the modeled potential compliance pathway. But the same is true for ICE vehicles that meet the Phase 3 emission standards, using other potential compliance pathways. The vehicles that comply with this rule are expected to have positive total costs of ownership over both five- and ten-year time horizons and thus we do not expect a significant increase in shipping rates and therefore we do not project mode shifts as a likely outcome of this regulation.<sup>1306</sup> Furthermore, no commenter suggested that mode shift was a reasonable outcome of our proposed standards.<sup>1307</sup> For more

<sup>1305</sup> The graph of monthly, seasonally adjusted heavy weight truck sales from the Bureau of Economic Analysis can be found at: <https://fred.stlouisfed.org/series/HTRUCKSSAAR>.

<sup>1306</sup> If manufacturers comply by adding technology to ICE vehicles, we also expect to see reduced operational costs through reduced fuel consumption.

<sup>1307</sup> We note that a study published by Argonne National Laboratory in 2017 indicates that if mode



information on mode shift, see Chapter 6.1.2 of the RIA.

iii. Class Shift

Class shift would occur if purchasers shift their vehicle purchase from one class of vehicle to another class of vehicle due to impacts of the rule on vehicle attributes, including performance and relative costs, among vehicle types that could practically be switched. Heavy-duty vehicles are typically configured and purchased to perform a function. For example, a concrete mixer truck is purchased to transport concrete, a combination tractor is purchased to move freight with the use of a trailer, and a Class 4 box truck could be purchased to make deliveries. The purchaser makes decisions based on many attributes of the vehicle, including the gross vehicle weight rating, which in part determines the amount of freight or equipment that can be carried. If the Phase 3 standards impact either the performance or cost of a vehicle relative to the other vehicle classes, then purchasers may choose to purchase a different vehicle, resulting in the unintended consequence of increased fuel consumption or GHG emissions in-use.

A purchaser in need of a specific vocational vehicle, such as a bus, box truck or street sweeper, would not be able to shift the purchase to a vehicle with a less stringent emission standard (such as the optional custom chassis standards for emergency vehicles, recreational vehicles, or mixed use (nonroad) type vehicles) and still meet their needs. The purchaser makes decisions based on many attributes of the vehicle, including the gross vehicle weight rating or gross combined weight rating of the vehicle, which in part determines the amount of freight or equipment that can be carried. Due to this, it is not likely feasible for purchasers to switch to other vehicle classes simply due to the emission standards.

In the proposed rule, we requested comment on data or methods to estimate the effect the emission standards might have on class shifting. Though we did not receive comment on data or methods, we did receive comment on possible class shifting, due to the differences between an ICE vehicle and its corresponding ZEV counterpart. EMA commented that ZEVs will require increased axle-capacity directly due to increased vehicle weight, or to ensure

shift were to occur as a result of this rule, it would likely result in further decreasing transportation GHG emissions and upstream energy usage. <https://publications.anl.gov/anlpubs/2017/08/137467.pdf>.

consistent payload under increased vehicle weight due to the weight of a battery. EMA commented that this may lead to driver shortages if vehicles shifted from Class 6 to Class 7, for example due to increased driver requirements, and will lead to increased costs, for example due to increased driver pay or the need to pay excise taxes if a vehicle shifts from Class 7 to Class 8.

As described in section II.D.3 of the preamble, we account for differences in vehicle uses and payload capacity in HD TRUCS, a tool we developed to for this rule to evaluate ZEV technologies. Our HD TRUCS analysis was then incorporated in our consideration of possible compliance pathways to support the feasibility of the final standards. In the modeled potential compliance pathway, we estimate the new vehicles produced and sold compliant with the rule, including ZEVs, are able to perform the same function as vehicles produced without the rule in place. For example, BEV technologies were not included within the potential compliance pathway in situations where the performance needs of a BEV would result in a battery that was too large or heavy due to the impact on payload and potential work accomplished relative to a comparable ICE vehicle. We assess the incremental weight increase or decrease of ZEVs compared to ICE vehicles in RIA Chapter 2.9.1. Also, it should be noted that for this final rule, we projected multiple pathways to compliance, including pathways that did not project an increase in ZEV penetration. Furthermore, although there are possible pathways that include reduced ZEV penetration compared to the modeled potential compliance pathway estimated in the analysis for this rule, there may also be greater ZEV penetration in one or more vehicle classes than we estimate in the modeled potential compliance pathway.

Class shift could also occur if one class of vehicle becomes significantly more expensive relative to another class of vehicle due to the technology and operating costs associated with the new emission standards. We expect class shifting, if it does occur, to be very limited because this rule applies new emission standards to all HD vehicle classes, as described in preamble section II. Furthermore, typically the purchase cost of heavy-duty vehicles increases with the class of the vehicle. In other words, a light heavy-duty box truck typically costs less to purchase and operate than a heavy heavy-duty box truck. The projected incremental upfront and operating costs to

purchasers in the modeled compliance pathway for this final rule do not lead to situations where the cost to purchase a heavier class of vehicle becomes lower than the cost to purchase a lighter class.<sup>1308</sup> In addition, the average payback period for the technologies in the modeled potential compliance pathway for all of the classes of vehicles are within the first ownership period, and our analysis shows a positive total cost of ownership over a five year time horizon.

In summary, we expect very little class shifting, if any, to occur. However, if a limited amount of shifting were to occur, we expect negligible emission impacts (compared to those emission reductions estimated to occur as a result of the emission standards).

iv. Domestic Production

These emission standards are not expected to provide incentives for manufacturers to shift between domestic and foreign production. This is because the emission standards apply to vehicles sold in the United States regardless of where such vehicles are produced. If foreign manufacturers already have increased expertise in satisfying the requirements of the emission standards, there may be some initial incentive for foreign production. However, given increasing global interest in reducing vehicle emissions, specifically through the use of ZEV technologies, as domestic manufacturers produce vehicles with reduced emissions, including ZEVs, the opportunity for domestic manufacturers to sell in other markets might increase. To the extent that the emission standards might lead to application and use of technologies that other countries may seek now or in the future, developing this capacity for domestic producers now may provide some additional ability to serve those markets. In addition, this rule and Federal actions including the IRA and BIL support the U.S. in our efforts to remain competitive on a global scale by encouraging and supporting the expansion of and investment in domestic manufacturing of ZEV technologies, supply chains, charging infrastructure and other industries related to green transportation technology.

As discussed in section B of the Executive Summary and RIA Chapter 1, the IRA contains tax credit incentives. The tax credit for the production and sale of battery cells and modules<sup>1309</sup> is

<sup>1308</sup> See preamble section II.F.2.ii.

<sup>1309</sup> The tax credit (45X) is for up to \$45 per kilowatt-hour (kWh), and for 10 percent of the cost

conditioned on such components or minerals being produced in the United States and, thus, is designed to encourage such domestic production.<sup>1310</sup> Our cost analysis reflects that in our modeled potential compliance pathway we project an increasing percentage of the batteries used in HD BEVs will be eligible for the up to \$45/kwh tax credit beginning in MY 2027 through MY 2032, in addition to consideration of the other tax incentives that apply to vehicle and EVSE purchasers, as described in section IV and RIA Chapter 3. For more information on comments received on possible impacts to domestic production of HD vehicles or components, and our responses, see the RTC section 19.

2. Purchaser Acceptance

In the modeled potential compliance pathway for the final rule, we project an increase in the adoption of HD BEVs and FCEVs for most of the HD vehicle types for MYs 2027 and beyond (see preamble section II or the RIA Chapter 2 for details).<sup>1311</sup> As explained in section IV and Chapter 3 of the RIA, though we estimate this rule will be associated with higher upfront vehicle costs for some vehicles, these costs are expected to be mitigated by operating costs savings. As explained in preamble section II and RIA Chapter 2, under the modeled potential compliance pathway, although some HD ZEVs produced and sold in response to this rule have higher incremental upfront purchaser vehicle cost difference between a ZEV and a comparable ICE vehicle (or higher incremental upfront purchaser cost difference when including consideration of EVSE, as applicable), our cost analysis shows that this incremental upfront purchaser cost difference will be partially or fully offset by a combination of the Federal vehicle tax credit and battery tax credit (and EVSE tax credit, as applicable) for HD ZEVs that are available through MY 2032, and further offset over time through operational savings.<sup>1312</sup> Our analysis shows that, in our modeled compliance pathway, the vehicle types

of producing applicable critical minerals (including those found in batteries and fuel cells, provided that the minerals meet certain specifications).

<sup>1310</sup>Note that the 30C charger credit has a requirement that eligible chargers must be installed in certain census tracts.

<sup>1311</sup>We again note that manufacturers may choose any compliance pathway that meets the final standards, including pathways that do not use ZEV technologies, and thus we note that ZEVs may not be purchased at the rates estimated in the modeled potential compliance pathway analyzed for this rule.

<sup>1312</sup>For more information on the Federal tax credits, see section ES.B of this preamble.

for which we project ZEV adoption for MY 2032 have an average payback period of between two and five years, depending on the regulatory group, when compared to a comparable ICE vehicle, even after considering the upfront purchaser and operating costs of the associated EVSE. See sections II and IV of this preamble and Chapters 2 and 3 of the RIA for more information on the estimated costs of this rule.

Businesses that operate HD vehicles are under competitive pressure to reduce operating costs, which should encourage purchasers to identify and rapidly adopt new vehicle technologies that reduce operating costs. As outlays for labor and fuel generally constitute the two largest shares of HD vehicle operating costs, depending on the price of fuel, distance traveled, type of HD vehicle, and commodity transported (if any), businesses that operate HD vehicles face strong incentives to reduce these costs.<sup>1313</sup> <sup>1314</sup>Potential savings in operating costs appear to offer strong incentives for HD vehicle buyers to pay higher upfront costs for vehicles that reduce operating costs, such as HD ZEVs. Economic theory suggests that a normally functioning competitive market would lead HD vehicle buyers to want to purchase, and HD vehicle manufacturers to incorporate, technologies that contribute to lower net costs.

In RIA Chapter 6.2, we discuss the possibility that an “energy efficiency gap” or “energy paradox” has existed, where available technologies that would reduce the total cost of ownership for the vehicle (when evaluated over their expected lifetimes using conventional discount rates) have not been widely adopted, or the adoption is relatively slow, despite their potential to repay buyers’ initial investments rapidly. The energy efficiency gap may exist due to constraints on access to capital for investment, imperfect or asymmetrical information about the new technology, uncertainty about supporting infrastructure, uncertainty about the resale market, and first-mover disadvantages for manufacturers. For example, purchasers may not consider the full, or even a portion of, the value of operational cost savings, due to uncertainty, such as uncertainty about future fuel prices, or purchaser uncertainty about the technology itself. Another example of when this may occur is if a principal-agent problem

<sup>1313</sup>American Transportation Research Institute, *An Analysis of the Operational Costs of Trucking*, September 2013. Docket ID: EPA-HQ-OAR-2014-0827-0512.

<sup>1314</sup>Transport Canada, *Operating Cost of Trucks*, 2005. Docket ID: EPA-HQ-OAR-2014-0827-0070.

exists, causing split incentives.<sup>1315</sup> In this section we discuss these potential issues that may impact the adoption of technologies like HD ZEVs, as well as factors (like this final rule) that may mitigate them. We expect these final Phase 3 standards as well as other factors we discuss will help overcome such barriers by incentivizing the development of technologies and supporting infrastructure that reduce operating costs and total cost of ownership, like ZEV technologies, and reduce uncertainties for HD vehicle purchasers on such technologies’ benefits and other potential concerns. Additionally, the final rule also sends a signal to electric utilities of demand under the potential compliance pathway, and thus provides support justifying buildout of electrification infrastructure.

The availability of existing incentives, including the Federal purchaser (vehicle and EVSE) and battery manufacturing tax credits in the IRA, is expected to lead to lower upfront costs for purchasers of HD ZEVs than would otherwise occur.<sup>1316</sup> We expect this will impact ZEV adoption rates by purchasers taking advantage of existing incentives to lower the upfront costs of purchasing HD ZEVs (including depot EVSE), which would result in higher ZEV adoption rates than would otherwise exist absent such incentives, and so counteract the energy efficiency gap for purchasers under the modeled potential compliance pathway for manufacturers.

In addition, as purchasers consider more of the operational cost savings of, for example, a ZEV over a comparable ICE vehicle in their purchase decision, the smaller the impact the higher upfront costs for purchasers have on that decision, and purchasers are more likely to purchase (in this example, a ZEV). However, for this example, uncertainty about ZEV technology, charging infrastructure technology and availability for BEVs, hydrogen refueling infrastructure for FCEVs, or uncertainty about future fuel and electricity prices may affect purchaser consideration of operational cost savings of ZEVs.<sup>1317</sup> Other areas of

<sup>1315</sup>A principal-agent problem happens when there is a conflict in priorities (split incentives) between a “principal,” or the owner of an asset, and an “agent,” or the person to whom control of the asset has been delegated, such as a manager or HD vehicle operator.

<sup>1316</sup>Note that the incentives exist in the reference scenario and under the scenario analyzed with our final standards.

<sup>1317</sup>We provide an assessment of charging infrastructure and the electric generation, transmission and distribution in preamble section II.

uncertainty include purchasers' impressions of BEV charging and FCEV fueling infrastructure support and availability, perceptions of the comparisons of quality and durability of different BEV powertrains, and resale value of the vehicle. We acknowledge that uncertainties, including those regarding infrastructure, could affect manufacturer compliance strategies, and could lead to compliance strategy decisions involving fewer ZEVs than we project in our modeled potential compliance pathway.

As discussed in detail in RIA Chapter 2.6 and 2.10.3, EPA has carefully analyzed the infrastructure needs and costs to support the modeled potential compliance pathway's technology packages that support the MY 2027–2032 standards. Additionally, as purchasers learn more about ZEV technologies, and as the penetration of the technologies and supporting infrastructure in the market increases, the exposure to ZEV technologies in the real world will reduce uncertainty related to viability or durability of the vehicles and the availability of supporting infrastructure. And though increasing penetration of HD ZEVs is projected to continue to happen regardless of the standards, as explained in our reference case, these standards are expected to help accelerate the process, incentivizing manufacturers to educate purchasers on the benefits of their compliance strategy technologies, like HD ZEVs. We note that, as explained in preamble section II.B.2.iii, EPA, in consultation with other agencies, has committed to engage with stakeholders to monitor compliance and major elements related to HD ZEV infrastructure, and to issue periodic reports reflecting this collected information in the lead up to these standards. These actions will also increase purchaser awareness and reduce uncertainty.

A principal-agent problem could exist if truck operators (agents) and truck purchasers who are not also operators (principals) value characteristics of the trucks under purchase consideration differently (split incentives) which could lead to differences in purchase decisions between truck operators and truck purchasers. Characteristics may include physical characteristics (for example noise, vibration or acceleration), cost characteristics (for example operational costs, purchase prices, or cost of EVSE installation), or other characteristics (for example availability of EVSE infrastructure). Such potential split incentives, or market failures, could, for example, impact HD ZEV adoption rates if agents

weigh characteristics more associated with ICE vehicles greater than those associated with ZEV vehicles in a manner different than represented in the analysis of the modeled compliance pathway for this rule. The possibility of a principal-agent problem could be mitigated through measures that cause an alignment of interests between the principal and the agent, for example, measures that lead to sharing of the benefits and/or costs that may cause the issue. While this is a theoretical issue, EPA is not aware of any data or analysis persuasively demonstrating if the principal-agent problem significantly affects HD vehicle purchases generally, or specifically with respect to HD ZEV purchases. However, we note that, given the commercial nature of how HD vehicles are used and the need to minimize costs in competitive business environments, we think it is reasonable, absent empirical evidence to the contrary, to conclude that truck purchasers are very unlikely to ignore the significant operational cost savings associated with HD ZEVs.

EPA recognizes that there is uncertainty related to technologies that manufacturers may adopt in their compliance strategies for this final rule, like ZEVs, that may impact the adoption of new technology even though it reduces operating costs. Markets for both new and used HD vehicles may face these problems, although it is difficult to assess empirically the degree to which they do. We expect these final Phase 3 standards will help overcome such barriers by incentivizing the development and deployment of technologies that reduced HD vehicle emissions, including ZEV technologies, and the development of supporting infrastructure, as well as the education of HD vehicle purchasers on the benefits of reduced emission technology and about ZEV infrastructure.

In the proposed rule, we requested comment and data on acceptance of HD ZEVs. Though we did not receive any data, we did receive many comments on ZEV acceptance and adoption, including assertions that the proposed rule would lead to reduced choice at the dealership because there will be fewer ICE vehicle models available to choose from, and that total ownership cost and return on investment for HD ZEVs is difficult to predict, in part because ZEVs are so new. Other commenters were in support of greater ZEV adoption, stating that the benefits of ZEVs, including their overall cost, driver appreciation, and sustainability, are drivers for adoption. Further detail regarding these comments and our responses is in RTC section 19.5.

In our modeled potential compliance pathway that supports the feasibility of the standards, we account for and consider willingness to purchase considerations in several ways (and, correspondingly, impacts on HD ZEV adoption included in the modeled potential compliance pathway). This includes considering uncertainty about vehicle weight, component (e.g., battery) sizing, infrastructure availability, upfront purchaser costs, and payback for purchasers, as well as including limitations in our analysis to phase in the final standards to provide additional time and a slower pace of adjustment in early model years. For example, our HD TRUCS analysis applies oversize factors for batteries to account for temperature effects, potential battery degradation and more; we sized most batteries for the 90th percentile of estimated VMT;<sup>1318</sup> and we sized EVSE such that vehicles' batteries could be fully recharged during the dwell time available to specific vehicle applications. In addition, in our HD TRUCS analysis we cap the ZEV adoption rate for each vehicle type to be no more than 70 percent for MY 2032 and no more than 20 percent in MY 2027. For more detail on the constraints we considered and included, see preamble sections II.D, II.E, and II.F. In the HD TRUCS analysis, we developed a method to include consideration of payback in assessing adoption rates of BEVs and FCEVs for the modeled potential compliance pathway after considering methods in the literature.<sup>1319</sup> Our payback curve, and methods considered and explored in the formulation of the method used in this rule, are described in RIA Chapter 2.7. As stated there, given information currently available, and our experience with the HD vehicle industry, payback period is the most relevant metric to the HD vehicle industry.<sup>1320</sup> The payback schedule caps used in our model are lower in MY 2027 compared to MY 2032 to recognize additional time for the

<sup>1318</sup> For the final rule, we sized batteries in BEVs that we expect to be charged en-route using public charging starting in MY 2030 at the 50th percentile daily VMT. For the longest range day cabs and sleeper cabs, on days when these vehicles are required to travel longer distances, we find that less than 30 minutes of mid-day charging at 1 MW is sufficient to meet the HD TRUCS 90th percentile VMT assuming vehicles start the day with a full battery.

<sup>1319</sup> Adoption rates estimated in HD TRUCS are one of several factors considered in determining the appropriate level of the standards. These estimated adoption rates in HD TRUCS demonstrate that the adoption rates in our modeled potential compliance pathway are all feasible.

<sup>1320</sup> Our assessment of total cost of ownership, shown in RIA Chapter 2.12, further supports our assessment of payback periods.

ZEV technology and infrastructure to mature. Fleet owners and drivers will have had more exposure to ZEV technology in 2032 compared to 2027, which may work to alleviate concerns related to ZEVs (for example, concerns of reliability) and result in a lower impression of risk of these newer technologies. In addition, infrastructure to support ZEV technologies will have had more time to expand and mature, further supporting increased HD ZEV adoption rates.

In summary, EPA recognizes that businesses that operate HD vehicles are under competitive pressure to reduce operating costs, which should encourage HD vehicle buyers to identify and rapidly adopt cost-effective technologies that reduce operating costs and the total cost of ownership. Outlays for labor and fuel generally constitute the two largest shares of HD vehicle operating costs, depending on the price of fuel, distance traveled, type of HD vehicle, and commodity transported (if any), so businesses that operate HD vehicles face strong incentives to reduce these costs. However, EPA also recognizes that there is uncertainty related to technologies that manufacturers may adopt in their compliance strategies for this final rule, like ZEVs, that may impact the adoption of these technologies even though they reduce operating costs. Markets for both new and used HD vehicles may face these problems, although it is difficult to assess empirically the degree to which they do. As explained in this section and RIA Chapter 6.2, we expect these final Phase 3 standards as well as other factors we discussed will help overcome such barriers by incentivizing the development of technologies and supporting infrastructure that reduce operating costs and total cost of ownership, like ZEV technologies, and reduce uncertainties for HD vehicle purchasers on such technologies' benefits and other potential concerns.

As explained in section II of the preamble, under the modeled potential compliance pathway the majority of new vehicles are projected to be ICE vehicles. Additionally, in this final rule, we emphasize that manufacturers have flexibility to choose among various compliance pathways to meet the standards that can include a mix of HD vehicle technologies; we analyzed a modeled potential compliance pathway to support the feasibility of the final standards, and we also provided additional example potential compliance pathways that utilizes only vehicles with ICE technologies relative to the reference case. Because there are multiple ways to comply with this rule,

and even under the modeled potential compliance pathway the majority of new vehicles are projected to be ICE vehicles, we expect that fleets and purchasers will be able to purchase the vehicle that works best for them given their circumstances. For fleets and purchasers, purchase decisions may include choosing a vehicle to comply with state or local policies as well as this rule, or choosing a vehicle that improves driver retention due to its characteristics. As noted, the final rule also sends a signal to electric utilities of demand under the modeled potential compliance pathway, and thus provides support justifying buildout of electrification infrastructure. As explained in section VI.E.1, the ability for manufacturers to comply through various compliance pathways is also expected to reduce the likelihood of pre- or low-buy that could potentially be associated with this rule.

### 3. VMT Rebound

Historically, the "rebound effect" has been interpreted as more intensive vehicle use, resulting in an increase in liquid fuel in response to increased ICE vehicle fuel efficiency. Although much of this possible vehicle use increase is likely to take the form of an increase in the number of miles vehicles are driven, it can also take the form of an increase in the loaded operating weight of a vehicle or altering routes and schedules in response to improved fuel efficiency. More intensive use of those HD ICE vehicles consumes fuel and generates emissions, which reduces the fuel savings and avoided emissions that would otherwise be expected to result from increasing fuel efficiency of HD ICE vehicles.

Unlike the LD vehicle rebound effect, there is little published literature on the HD vehicle rebound effect, and all of it focuses on the rebound effect due to increased ICE fuel efficiency. Winebrake et al. (2012) suggest that vocational trucks and tractor trailers have a rebound effect of essentially zero.<sup>1321</sup> Leard et al. (2015) estimate that tractor trailers have a rebound effect of 30 percent, while vocational vehicles have a 10 percent rebound rate.<sup>1322</sup> Patwary et al. (2021) estimated that the average rebound effect of the U.S. road freight sector is between about 7 to 9 percent, although their study indicated that

rebound has increased over time.<sup>1323</sup> This is slightly smaller than the value found by Leard et al. (2015) for the similar sector of tractors.

With respect to ZEVs specifically, we do not have data that operational cost savings of switching from an ICE vehicle to a ZEV will affect the VMT driven of that vehicle, nor do we have data on how changing fuel prices might affect VMT of ZEVs over time. Given the increasing penetration of ZEVs in the HD fleet even in the reference case, as explained in preamble section V, as well as the wide range of effects discussed in the literature, we do not believe the rebound estimates in literature cited here are appropriate for use in our analysis. In addition, the majority of research on VMT rebound has been performed in the light-duty vehicle context. The factors influencing light-duty and heavy-duty VMT are generally different. For example, light-duty VMT is generally related to personal considerations, including costs and benefits associated with driving, while HD VMT is more a function of profits or impacts on labor. It is also important to note that even if there is an increase in VMT in new vehicles, this may be offset by a decrease in VMT on older vehicles. This may occur if operational cost savings on newer vehicles due to this rule lead operators to shift VMT to these newer, more efficient vehicles.

If rebound rates are positive, we would assume that higher rebound rates are associated with larger responses to a change in the cost per mile of travel, which could result in some increase in non-GHG emissions and in brake and tire wear, but also an increase in benefits associated with increased vehicle use (for example, increased economic activity associated with the services provided by those vehicles), as well as positive impacts on employment. However, lower rebound rates may happen if owner/operators use those cost savings in other ways, for example, to reduce their payback period. Also, as noted in the Winebrake et al. (2012) study, possible rebound impacts are likely reduced by adjustments in other operational costs such as labor, and the nature of the freight industry as an input to a larger supply chain system. As in the proposal, we are not estimating any VMT rebound due to this rule (88 FR 26072). Comments received on this issue, and our response to them, can be found in RTC section 19.2.

<sup>1321</sup> Winebrake, J.J., Green, E.H., Comer, B., Corbett, J.J., Froman, S., 2012. Estimating the direct rebound effect for on-road freight transportation. *Energy Policy* 48, 252–259.

<sup>1322</sup> Leard, B., Linn, J., McConnell, V., and Raich, W. (2015). Fuel Costs, Economic Activity, and the Rebound Effect for Heavy-Duty Trucks. Resources For the Future Discussion Paper, 14–43.

<sup>1323</sup> Patwary, A.L., Yu, T.E., English, B.C., Hughes, D.W., and Cho, S.H. (2021). Estimating the rebound effect of the US road freight transport. *Transportation Research Record*, 2675(6), 165–174.

4. Employment Impacts

Economic theories of labor demand indicate that employers affected by environmental regulation may change their demand for different types of labor in different ways, increasing demand for some types, decreasing demand for other types, or not changing it at all for still other types. A variety of conditions can affect employment impacts of environmental regulation, including baseline labor market conditions and employer and worker characteristics such as industry and region. A growing body of literature has examined employment effects of environmental regulation. Morgenstern et al. decompose the labor consequences in a regulated industry facing increased abatement costs.<sup>1324</sup> This study identifies three separate components of labor demand effects. First, there is a demand effect caused by higher production costs, which in turn, results in increased market prices. Increased market prices reduce consumption (and production), thereby reducing demand for labor within the regulated industry. Second, there is a cost effect. As production costs increase, manufacturing plants use more of all inputs, including labor, to produce the same level of output. Third, there is a factor-shift effect, which occurs when post-regulation production technologies may have different labor intensities than pre-regulation production technologies.<sup>1325</sup>

Due to a lack of data, we are not able to estimate employment effects from this rule. The overall effect of the rule on employment in the heavy-duty vehicle manufacturing sector depends on the relative magnitude of factor-shift, cost, and demand effects, as well as possible differences in employment related to HD ICE and ZEV manufacturing under the potential compliance pathway. A market shift to HD ZEVs will lead to a shift in employment needs as well. In Chapter 6.4.2 of the RIA, we show that the amount of labor per million dollars in sales in motor vehicle manufacturing sectors has generally declined over the last fifteen years, indicating that fewer people have been needed to produce the same value of goods. For example, in 2008, motor vehicle body and trailer

manufacturing employed about 4.8 employees per million dollars in sales, falling to just under 3.7 employees per million dollars in sales in 2022. In the electrical equipment manufacturing sector, which is involved in the production of components that go in to BEVs and the battery electric portion of PHEVs, employment has increased over the last fifteen years, rising from about 3.3 employees per million dollars in sales in 2007 to about 4.1 employees per million dollars in sales in 2022.

The International Union, United Automobile, Aerospace and Agricultural Implement Workers of America (UAW) has stated that re-training programs will be needed to support auto workers in a market with an increasing share of electric vehicles in order to prepare workers that might be displaced by the shift to the new technology.<sup>1326</sup> In comments on the proposed rule, the UAW stated support for emission reductions, though they also indicated a slower phase in of ZEVs into the market than that projected in the proposal would better support employees in auto manufacturing and supporting industries. Volkswagen has stated that labor requirements for ICE vehicles are about 70 percent higher than their electric counterpart, but these changes in employment intensities in the manufacturing of the vehicles can be offset by shifting to the production of new components, for example batteries or battery cells.<sup>1327</sup> Climate Nexus has indicated that increasing penetrations of electric vehicles will lead to a net increase in jobs, a claim that is partially supported by the rising investment in batteries, vehicle manufacturing and charging stations.<sup>1328</sup> Though most of these statements are specifically referring to light-duty vehicles, they hold true for the HD market as well.

The expected investment mentioned by Climate Nexus is also supported by recent Federal investment which will allow for increased investment along the vehicle supply chain, including domestic battery manufacturing,

charging infrastructure, and vehicle manufacturing, both in the LD and HD markets.<sup>1329</sup> This investment includes the BIL, the CHIPS Act,<sup>1330</sup> and the IRA, which are expected to create domestic employment opportunities along the full automotive sector supply chain, from components and equipment manufacturing and processing to final assembly, as well as incentivize the development of reliable EV battery supply chains, both for BEVs and PHEVs.<sup>1331</sup> For example, the IRA is expected to impact domestic employment through conditions on eligibility for purchase incentives and battery manufacturing incentives. These conditions include contingencies for domestic assembly, domestic critical minerals production, and domestic battery manufacturing. As an example, a new joint venture between Daimler Trucks, Cummins, and PACCAR recently announced a new battery factory to be built in the U.S. to manufacture cells and packs initially focusing on heavy-duty and industrial applications was announced in September 2023.<sup>1332</sup> The BlueGreen Alliance and the Political Economy Research Institute estimate that IRA will create over 9 million jobs over the next decade, with about 400,000 of those jobs being attributed directly to the battery and fuel cell vehicle provisions in the act.<sup>1333</sup> As discussed in RTC section

<sup>1329</sup> See preamble section I for information on the BIL and IRA provisions relevant to vehicle electrification, and the associated infrastructure.

<sup>1330</sup> The CHIPS Act is the Creating Helpful Incentives to Produce Semiconductors and Science Act and was signed into law on August 9, 2022. It is designed to strengthen supply chains, domestic manufacturing and national security. More information can be found at <https://www.whitehouse.gov/briefing-room/statements-releases/2022/08/09/fact-sheet-chips-and-science-act-will-lower-costs-create-jobs-strengthen-supply-chains-and-counter-china/>.

<sup>1331</sup> More information on how these acts are expected to aid employment growth and create opportunities for growth along the supply chain can be found in the January, 2023 White House publication "Building a Clean Energy Economy: A Guidebook to the Inflation Reduction Act's Investments in Clean Energy and Climate Action." found online at <https://www.whitehouse.gov/wp-content/uploads/2022/12/Inflation-Reduction-Act-Guidebook.pdf>.

<sup>1332</sup> Daimler Trucks North America. "Accelera by Cummins, Daimler Truck and PACCAR form a joint venture to advance battery cell production in the United States." September 6, 2023. Available online: <https://media.daimlertruck.com/marsMediaSite/en/instance/ko/Accelera-by-Cummins-Daimler-Truck-and-PACCAR-form-a-joint-venture-to-advance-battery-cell-production-in-the-United-States.xhtml?oid=52385590> (last accessed October 23, 2023).

<sup>1333</sup> Note that these are not all net new employment and reflects where workers may be hired away from other jobs. As the labor market gets tighter and the economy is closer to full employment, there will be a greater number of

<sup>1324</sup> Morgenstern, R.D.; Pizer, W.A.; and Shih, J.-S. "Jobs Versus the Environment: An Industry-Level Perspective." *Journal of Environmental Economics and Management* 43: 412–436. 2002.

<sup>1325</sup> Additional literature using similar frameworks include Berman and Bui (2001) and Deschênes (2018). For more information on this literature, see the Chapter 10 of the RIA for the HD2027 rule, found at Docket ID EPA–HQ–OAR–2019–0055.

<sup>1326</sup> More information on UAW's comments can be found in the white paper "Making EVs work for American workers" found at <https://uaw.org/wp-content/uploads/2019/07/190416-EV-White-Paper-REVISED-January-2020-Final.pdf>.

<sup>1327</sup> Herrmann, F., Beinbauer, W., Borrmann, D., Hertwig, M., Mack, J., Potinecke, T., Praeg, C., Rally, P. 2020. Effects of Electric Mobility and Digitalisation on the Quality and Quantity of Employment at Volkswagen. Fraunhofer Institute for Industrial Engineering IAO. Study on behalf of the Sustainability Council of the Volkswagen Group. [https://www.volkswagenag.com/presence/stories/2020/12/frauenhofer-studie/6095\\_EMDI\\_VW\\_Summary\\_um.pdf](https://www.volkswagenag.com/presence/stories/2020/12/frauenhofer-studie/6095_EMDI_VW_Summary_um.pdf).

<sup>1328</sup> See the report from Climate Nexus at <https://climatenexus.org/climate-issues/energy/ev-job-impacts/>.

19.6, there are many existing and planned projects focused on training new and existing employees in fields related to green jobs, and specifically green jobs associated with electric vehicle production, maintenance and repair and the associated charging infrastructure. This includes work by the Joint Office of Energy and Transportation, created by the BIL, which supports efforts related to deploying infrastructure, chargers and zero emission transit and school buses. In addition, the IRA is expected to lead to increased demand in ZEVs through tax credits for purchasers of ZEVs.

The factor-shift effect on employment reflects potential employment changes due to changes in labor intensity of production resulting from compliance activities. The final standards do not mandate the use of a specific technology, and EPA anticipates that a compliant fleet under the standards will include a diverse range of technologies including ICE vehicle and ZEV technologies. ZEVs and ICE vehicles require different inputs and have different costs of powertrain production, though there are many common parts as well. There is little research on the relative labor intensity needs of producing a HD ICE vehicle versus producing a comparable HD ZEV. Though there are some news articles and research from the light-duty motor vehicle market, they do not provide a clear indication of the relationship between employment needs for ZEVs and ICE vehicles. Some studies find that LD BEVs are less complex, requiring fewer person-hours to assemble than a comparable ICE vehicle.<sup>1334</sup> Others find that there is not a significant difference in the employment needed to produce ICE vehicles when compared to ZEVs.<sup>1335</sup>

EPA worked with a research group to produce a peer-reviewed tear-down study of a light-duty BEV (Volkswagen ID.4) to its comparable ICE vehicle

employees shifting from one job to another. More information can be found in: Political Economy Research Institute. (2022). *Job Creation Estimates Through Proposed Inflation Reduction Act*. University of Massachusetts Amherst. Retrieved from <https://www.bluegreenalliance.org/site/9-million-good-jobs-from-climate-action-the-inflation-reduction-act>.

<sup>1334</sup> Barret, J. and Bivens, J. (2021). The stakes for workers in how policymakers manage the coming shift to all-electric vehicles. Economic Policy Institute. <https://www.epi.org/publication/ev-policy-workers>.

<sup>1335</sup> Kupper, D., Kuhlmann, K., Tominaga, K., Arora, A., Schlageter, J. (2020). Shifting Gears in Auto Manufacturing. <https://www.bcg.com/publications/2020/transformation-impact-of-electric-vehicles-on-auto-manufacturing>.

counterpart (Volkswagen Tiguan).<sup>1336</sup> Included in this study are estimates of labor intensity needed to produce each vehicle under three different assumptions of vertical integration of manufacturing scenarios ranging from a scenario where most of the assemblies and components are sourced from outside suppliers to a scenario where most of the assemblies and components are assembled in house. Under the low and moderate levels of vertical integration, results indicate that assembly of the BEV at the plant is reduced compared to assembly of the ICE vehicle. Under a scenario of high vertical integration, which includes the BEV battery assembly, results show an increase in time needed to assemble the BEV. When powertrain systems are ignored (battery, drive units, transmission and engine assembly), the BEV requires more time to assemble under all three vertical integration scenarios. The results indicate that the largest difference in assembly comes from the building of the battery pack assembly. When the battery cells are built in-house, the BEV will require more hours to build. What is not discussed in this research is that battery cells must be built, regardless of where that occurs. Battery plants are being built and announced in the US, with support from the IRA, BIL and CHIPS, as discussed in section II.D.

Though we have more information today on differences in the time it takes to build an ICE vehicle and a comparable BEV or PHEV, we do not have enough information to estimate an effect of our rule based on this information. We do not know how OEMs will be (and are) manufacturing their vehicles, nor do we know what this will look like in several years as the MY 2027 and later standards become effective and there is projected to be an increase in the share of BEVs being produced and sold. We can say, generally, that this study indicates that if production of EVs and their power supplies are done in the US at the same rates as ICE vehicles, we do not expect employment to fall, and it may likely increase. In addition, data on the labor intensity of PHEV production compared to ICE vehicle production is also very sparse. PHEVs share features with both ICE vehicles (including engines and exhaust assemblies) and BEVs (including motors and batteries). If labor is a factor of the number of components,

<sup>1336</sup> FEV Consulting Inc., "Cost and Technology Evaluation, Conventional Powertrain Vehicle Compared to an Electrified Powertrain Vehicle, Same Vehicle Class and OEM," prepared for Environmental Protection Agency, EPA Contract No. 68HERC19D00008, February 2023.

PHEVs might have a higher labor intensity of production compared to both BEV and ICE vehicles. We do not have data on employment differences in traditional ICE vehicle manufacturing sectors and ZEV manufacturing sectors, especially for expected effects in the future, nor do we have data on the employment needed for the level of battery production we anticipate will be required to meet future HD ZEV demand projected in our potential compliance pathway.

The demand effect reflects potential employment changes due to changes in new HD vehicle sales. If HD ICE vehicle sales decrease, fewer people would be needed to assemble trucks and the components used to manufacture them. On the other hand, if HD ZEV sales increase, more people would be needed to assemble HD ZEVs and their components, including batteries. If HD ICE vehicle sales decrease while HD ZEV sales increase, the net change in employment will depend on the relative employment needs for each vehicle type. Additional, short-term, effects might be seen if pre-buy or low-buy were to occur. If pre-buy occurs, HD vehicle sales may increase temporarily, leading to temporary increases in employment in the related manufacturing sectors. If low-buy occurs, there may be temporary decreases in employment in the manufacturing sectors related to HD vehicles. However, as noted, EPA does not expect significant pre-buy or low-buy resulting from this rule. In addition, as noted in preamble section E.1, we do not anticipate much mode or class shift in HD market affected by this rule, which also supports a minimal demand effect on employment.

The cost effect reflects the potential impact on employment due to increased costs from adopting technologies needed for vehicles to meet the new emission standards. In the HD ICE vehicle manufacturing sector, if firms invest in lower emitting HD ICE vehicles, we would expect labor to be used to implement those technologies. For firms producing ZEVs, we do not expect the rule to require additional compliance activities, as ZEVs, by definition, emit zero tailpipe emissions.<sup>1337</sup> In addition, the standards do not mandate the use of a specific technology, and EPA anticipates that a compliant fleet under the standards will include a diverse range of technologies including ICE and ZEV technologies.

<sup>1337</sup> We note that there may be indirect impacts, for example through battery durability monitoring or warranty requirements. See preamble section III.B for more information on these requirements.

Under the additional compliance pathways projected for this final rule that include only technology adoption in ICE vehicles, we expect there could be some increase in employment related to implementing these ICE technologies. However, the level of employment due to implementing new ICE technology as result of this rule will depend on the relative rate of the adoption of the technology.

In the proposed rule, we requested comment on data and methods that could be used to estimate the potential effects of this action on employment in HD vehicle manufacturing sectors, and on how increasing electrification in the HD market in general might impact employment in HD manufacturing sectors, both for ICE powertrains as well as electrified powertrains. We also requested comment on data and methods to estimate possible effects of the emission standards on employment in the HD ICE and ZEVs manufacturing markets.<sup>1338</sup> Comments received mainly stated that the regulation might negatively impact job quality, as well as that there will be geographically localized effects, even if national level net impacts are minimal. We acknowledge the possibility of geographically localized effects, and that there may be job quality impacts associated with this rule, especially in the short term. We do not, however, have data to estimate current or future job quality. As described throughout section 19.6 of the RTC, we note that there are ongoing actions by the Departments of Energy (DOE) and Labor (DOL), as well as others, supporting green jobs, including the Office of Energy Jobs, which is particularly focused on jobs with high standards and the right to collective bargaining. In addition, we are unable to determine the future location of vehicle manufacturing and supporting industries beyond the public announcements made as of the publication of this rule. Also, we point out that even though vehicle manufacturing and battery manufacturing may create more localized employment effects, infrastructure work is, and will continue to be, a nation-wide effort. For more on the comments we received on the labor impacts of the proposed rule, and our responses, see section 19.6 of the RTC document.

As the share of ZEVs in the HD market increases, there may also be effects on employment in associated ZEV industries, including battery production and BEV charging infrastructure industries as well as

hydrogen refueling infrastructure industries. These impacts may occur in several ways, including through greater demand for batteries and therefore increased employment needs. In addition, increased demand for charging and hydrogen fueling infrastructure to support more ZEVs may lead to more private and public charging and fueling facilities being constructed, or to greater use of existing facilities, which can lead to increased maintenance needs for those facilities. For example, as described in RIA Chapter 2.10.3, we estimated the total number of EVSE ports that will be required to support the depot-charged BEVs in the technology packages developed to support the MY 2027–2032 standards. We find just under 500,000 EVSE ports will be needed across all six model years. This increased demand in EVSE will increase employment in this sector.

In the proposed rule, we requested comment on data and methods that could be used to estimate the effect of this action on the HD BEV vehicle charging infrastructure industry. We received comments stating that there will be shortage of qualified BEV technicians, as well as technicians qualified to repair and maintain infrastructure. We also received comments stating that there has already been significant job creation in response to demand for battery production, with the expectation that battery and charging infrastructure will create many more jobs. We note first that the vehicle market is moving toward increasing ZEV market share, with or without this rule. We also note that there are many potential pathways to comply with this rule, and regardless of the outcome, we project that ICE vehicles will remain a significant share of new vehicle sales through MY 2032, as well as remain the majority share of the fleet for many years after. The pace of ZEV uptake should provide ample opportunity for training programs to be implemented, especially if there is demand, or lack of supply, for qualified technicians. In addition, there are many labor and employment initiatives happening related to electric vehicles, including those related to battery production and supply chain, vehicle manufacturing and deployment, refueling infrastructure, maintenance and repair of electric vehicles and more.<sup>1339</sup> These programs include initiatives to promote production and availability and also to train, and retrain, workers in support of

increasing high quality employment related to green energy.

Because of the diversity of the HD vehicle market, we expect that entities from a wide range of transportation sectors will purchase vehicles subject to the emission standards. HD vehicles are typically commercial in nature, and typically provide an “intermediate good,” meaning that such vehicles are used to provide a commercial service (transporting goods, municipal service vehicles, etc.), rather than serving as final consumer goods themselves (as most light-duty vehicles do). As a result, the purchase price of a new HD vehicle likely impacts the price of the services provided by that vehicle. Operating costs and purchase incentives may also impact the price of services provided. If a change in upfront cost and/or operating costs, including purchase incentives (as might be available for a new ZEV), results in higher prices for the services provided by these vehicles compared to the same services provided by a pre-regulation vehicle, it may reduce demand for the services such vehicles provide. In turn, there may be less employment in the sectors providing such services. On the other hand, if there are savings that are passed on to consumers through lower prices for services provided, it may lead to an increase in demand for those services, and therefore may lead to an increase in employment in those sectors providing those services. We estimate that there are savings over the life of operating a ZEV relative to an ICE vehicle that may decrease downstream prices. We expect that the actual effects on demand for the services provided by these vehicles and related employment will depend on cost pass-through, as well as responsiveness of demand to changes in transportation cost, should such changes occur.<sup>1340</sup>

This action may also produce employment effects in other sectors, for example, in firms providing liquid fuel. While reduced liquid fuel consumption represents cost savings for purchasers of liquid fuel, it could also represent a loss in value of output for the petroleum refining industry, which could result in reduced employment in that sector. These impacts may also pass up the supply chain to, for example, pipeline construction, operation and maintenance, and domestic oil production. In this final rule, we estimate that the reduction in fuel consumption will be met by increasing net exports by half of the amount of

<sup>1339</sup> See the memo from the U.S. Department of Labor to Elizabeth Miller on Labor/Employment Initiatives in the Battery/Vehicle Electrification Space, located in the docket.

<sup>1340</sup> Cost pass-through refers to the amount of increase in up-front cost incurred by the HD vehicle owner that is then passed on to their customers in the form of higher prices for services provided by the HD vehicle owner.

<sup>1338</sup> 88 FR 26074.

reduced domestic demand for refined product, with the other half being met by reductions in U.S. refinery output. Though the reduced domestic output may lead to future closures or conversions of individual refineries, we are unable to estimate the future decisions of refineries to keep operating, shut down or convert away from fossil fuels because they depend on the economics of individual refineries, economic conditions of parent companies, long-term strategies for each company, and on the larger macro-economic conditions of both the U.S. and the global refinery market, and therefore we are unable to estimate the possible effect this rule will have on employment in the petroleum refining sector. However, because the petroleum refining industry is material-intensive and not labor intensive, and we estimate that only part of the reduction in liquid fuel consumption will be met by reduced refinery production in the U.S., see RIA Chapter 6.5, we expect that any employment effect due to reduced petroleum demand will be small. Commenters stated concerns that employment in the petroleum refining industry will fall because plants will close, while others more generally stated that oil worker jobs will be devastated. For our response to these comments, see section 19.6 of the RTC document.

This action could also provide some positive impacts on driver employment in the heavy-duty trucking industry. As discussed in section IV of this preamble, the reduction in fuel costs from purchasing a ZEV instead of an ICE vehicle will be expected to not only reduce operational costs for ZEV owners and operators compared to an ICE vehicle, but may also provide additional incentives to purchase a HD ZEV over a HD ICE vehicle. For example, the Clean Air Task Force and ZETA submitted comments stating the HD ZEVs are associated with increased driver satisfaction due to quieter operations, better visibility, a smoother ride, faster acceleration, less odor, and a smoother and safer experience when driving in high traffic or urban environments. The commenters state that these positive attributes have the possibility of decreasing truck driver shortages and increasing driver retention.

An additional factor to consider for employment impacts across all industries that might be affected by this rule under the potential compliance pathway, or by the increase in the share of HD ZEVs in the market, is that though more ZEVs are being introduced to the market regardless of this rule, the

vehicles on the road will still continue to be dominated by HD ICE vehicles, and many HD ICE vehicles will continue to be sold. This gradual shift avoids abrupt changes and will reduce impacts in acceptance, infrastructure availability, employment, supply chain, and more.

#### F. Oil Imports and Electricity and Hydrogen Consumption

We project that the final standards will reduce not only GHG emissions but also liquid fuel consumption (*i.e.*, oil consumption) while simultaneously increasing electricity and hydrogen consumption. Reducing liquid fuel consumption is a significant means of reducing GHG emissions from the transportation sector. As discussed in section V and RIA Chapter 4, we used an updated version of EPA’s MOVES model to estimate the impact of the final standards on heavy-duty vehicle emissions, fuel consumption, electricity consumption, and hydrogen consumption. In Chapter 6.5 of the RIA, we present fossil fuel—diesel, gasoline, CNG—consumption impacts. Table 6–1 in Chapter 6 of the RIA shows the estimated reduction in U.S. oil imports under the final standards relative to the reference case scenario. This final rule is projected to reduce U.S. oil imports by 3 billion barrels through 2055 (see Table 6–2 of the RIA). The oil import reductions are the result of reduced consumption (*i.e.*, reduced liquid fuel demand) of both diesel fuel and gasoline and our estimate that 94.8 percent of reduced liquid fuel demand results in reduced imports.<sup>1341</sup> RIA Table 6–2 also includes the projected increase in electricity and hydrogen consumption due to the final rule.

### VII. Benefits of the Program

In this section, we describe three sets of monetized benefits for the program and the methodology we use to calculate those benefits: climate benefits related to GHG emissions reductions calculated using the social cost of GHGs, the health benefits related to reductions in non-GHG pollutant emissions, and energy security benefits.

EPA monetizes the benefits of the standards in part to better enable a comparison of costs and benefits pursuant to E.O. 12866, but we recognize that there are benefits that we

are currently unable to fully quantify. EPA’s consistent practice has been to set standards to achieve improved air quality consistent with Clean Air Act (CAA) section 202 and not to rely on cost-benefit calculations, with their uncertainties and limitations, in identifying the appropriate standards. Nonetheless, as explained in section VIII of this preamble, our conclusion that the estimated benefits exceed the estimated costs of the program reinforces our view that the final standards represent an appropriate weighing of the statutory factors and other relevant considerations.

#### A. Climate Benefits

EPA estimates the climate benefits of GHG emissions reductions expected from the final rule using estimates of the social cost of greenhouse gases (SC–GHG) that reflect recent advances in the scientific literature on climate change and its economic impacts and incorporate recommendations made by the National Academies of Science, Engineering, and Medicine.<sup>1342</sup> EPA published and used these estimates in the RIA for Final Oil and Gas NSPS/EG Rulemaking, “Standards of Performance for New, Reconstructed, and Modified Sources and Emissions Guidelines for Existing Sources: Oil and Natural Gas Sector Climate Review”, which was signed by the EPA Administrator on December 2, 2023.<sup>1343</sup> EPA solicited public comment on the methodology and use of these estimates in the RIA for the agency’s December 2022 Oil and Gas NSPS/EG Supplemental Proposal and has conducted an external peer review of these estimates, as described further in this section. Section 7.1 of the RIA lays out the details of the updated SC–GHG used within this final rule.

The SC–GHG is the monetary value of the net harm to society associated with a marginal increase in GHG emissions in a given year, or the net benefit of avoiding that increase. In principle, SC–GHG includes the value of all climate change impacts (both negative and positive), including (but not limited to) changes in net agricultural productivity, human health effects, property damage from increased flood risk and natural

<sup>1342</sup> National Academies of Sciences, Engineering, and Medicine (National Academies). 2017. Valuing Climate Damages: Updating Estimation of the Social Cost of Carbon Dioxide. National Academies Press.

<sup>1343</sup> U.S. EPA. (2023f). *Supplementary Material for the Regulatory Impact Analysis for the Final Rulemaking, “Standards of Performance for New, Reconstructed, and Modified Sources and Emissions Guidelines for Existing Sources: Oil and Natural Gas Sector Climate Review”*: EPA Report on the Social Cost of Greenhouse Gases: Estimates Incorporating Recent Scientific Advances. Washington, DC: U.S. EPA.

<sup>1341</sup> The 94.8 percent import reduction factor is based upon revised throughput assumptions for U.S. refineries in response to a decline in product demand as a result of this final rule. See Chapter 7.3.4 of the RIA for how the 94.8 percent is calculated assuming the refiners maintain refinery throughput at 50 percent of the decline in product demand as a result of this rule by exporting refined products.



disasters, disruption of energy systems, risk of conflict, environmental migration, and the value of ecosystem services. The SC–GHG, therefore, reflects the societal value of reducing emissions of the gas in question by one metric ton and is the theoretically appropriate value to use in conducting benefit-cost analyses of policies that affect GHG emissions. In practice, data and modeling limitations restrain the ability of SC–GHG estimates to include all physical, ecological, and economic impacts of climate change, implicitly assigning a value of zero to the omitted climate damages. The estimates are, therefore, a partial accounting of climate change impacts and likely underestimate the marginal benefits of abatement.

Since 2008, the EPA has used estimates of the social cost of various greenhouse gases (*i.e.*, SC–CO<sub>2</sub>, SC–CH<sub>4</sub>, and SC–N<sub>2</sub>O), collectively referred to as the “social cost of greenhouse gases” (SC–GHG), in analyses of actions that affect GHG emissions. The values used by the EPA from 2009 to 2016, and since 2021—including in the proposal for this rulemaking—have been consistent with those developed and recommended by the IWG on the SC–GHG; and the values used from 2017 to 2020 were consistent with those required by Executive Order (E.O.) 13783, which disbanded the IWG. During 2015–2017, the National Academies conducted a comprehensive review of the SC–CO<sub>2</sub> and issued a final report in 2017 recommending specific criteria for future updates to the SC–CO<sub>2</sub> estimates, a modeling framework to satisfy the specified criteria, and both near-term updates and longer-term research needs pertaining to various components of the estimation process.<sup>1344</sup> The IWG was reconstituted in 2021 and E.O. 13990 directed it to develop a comprehensive update of its SC–GHG estimates, recommendations regarding areas of decision-making to which SC–GHG should be applied, and a standardized review and updating process to ensure that the recommended estimates continue to be based on the best available economics and science going forward.

EPA is a member of the IWG and is participating in the IWG’s work under E.O. 13990. As noted in previous EPA RIAs—including in the proposal RIA for this rulemaking, while that process continues, the EPA is continuously reviewing developments in the scientific literature on the SC–GHG, including more robust methodologies for estimating damages from emissions, and looking for opportunities to further

improve SC–GHG estimation.<sup>1345</sup> In the December 2022 Oil and Gas Supplemental Proposal RIA,<sup>1346</sup> the Agency included a sensitivity analysis of the climate benefits of that rule using a new set of SC–GHG estimates that incorporates recent research addressing recommendations of the National Academies<sup>1347</sup> in addition to using the interim SC–GHG estimates presented in the *Technical Support Document: Social Cost of Carbon, Methane, and Nitrous Oxide Interim Estimates under Executive Order 13990*<sup>1348</sup> that the IWG recommended for use until updated estimates that address the National Academies’ recommendations are available. The EPA solicited public comment on the sensitivity analysis and the accompanying draft technical report, External Review Draft of Report on the Social Cost of Greenhouse Gases: Estimates Incorporating Recent Scientific Advances, which explains the methodology underlying the new set of estimates and was included as supplementary material to the RIA for the December 2022 Supplemental Oil and Gas Proposal.<sup>1349</sup> The response to comments document can be found in the docket for that action.<sup>1350</sup>

To ensure that the methodological updates adopted in the technical report are consistent with economic theory and reflect the latest science, the EPA also initiated an external peer review panel to conduct a high-quality review of the technical report (see 88 FR 29372 noting this peer review process was ongoing at the time of our proposal), completed in May 2023. The peer reviewers commended the agency on its development of the draft update, calling

<sup>1345</sup> EPA strives to base its analyses on the best available science and economics, consistent with its responsibilities, for example, under the Information Quality Act.

<sup>1346</sup> U.S. EPA. (2023). Supplementary Material for the Regulatory Impact Analysis for the Final Rulemaking, “Standards of Performance for New, Reconstructed, and Modified Sources and Emissions Guidelines for Existing Sources: Oil and Natural Gas Sector Climate Review”: EPA Report on the Social Cost of Greenhouse Gases: Estimates Incorporating Recent Scientific Advances. Washington, DC: U.S. EPA.

<sup>1347</sup> U.S. EPA. (2023).

<sup>1348</sup> Interagency Working Group on Social Cost of Carbon (IWG). 2021 (February). Technical Support Document: Social Cost of Carbon, Methane, and Nitrous Oxide: Interim Estimates under Executive Order 13990. United States Government.

<sup>1349</sup> <https://www.epa.gov/environmental-economics/scghg-td-peer-review>.

<sup>1350</sup> Supplementary Material for the Regulatory Impact Analysis for the Final Rulemaking, “Standards of Performance for New, Reconstructed, and Modified Sources and Emissions Guidelines for Existing Sources: Oil and Natural Gas Sector Climate Review”, EPA Report on the Social Cost of Greenhouse Gases: Estimates Incorporating Recent Scientific Advances, Docket ID No. EPA–HQ–OAR–2021–0317, November 2023.

it a much-needed improvement in estimating the SC–GHG and a significant step towards addressing the National Academies’ recommendations with defensible modeling choices based on current science. The peer reviewers provided numerous recommendations for refining the presentation and for future modeling improvements, especially with respect to climate change impacts and associated damages that are not currently included in the analysis. Additional discussion of omitted impacts and other updates were incorporated in the technical report to address peer reviewer recommendations. Complete information about the external peer review, including the peer reviewer selection process, the final report with individual recommendations from peer reviewers, and the EPA’s response to each recommendation is available on EPA’s website.<sup>1351</sup>

Section 7.1 within the RIA provides an overview of the methodological updates incorporated into the SC–GHG estimates used in this final rule. A more detailed explanation of each input and the modeling process is provided in the final technical report, *EPA Report on the Social Cost of Greenhouse Gases: Estimates Incorporating Recent Scientific Advances*.<sup>1352</sup>

Commenters on our HD GHG Phase 3 NPRM brought up issues regarding baseline scenarios, climate modeling (*e.g.*, equilibrium climate sensitivity) and IAMS, claiming that they all used outdated assumptions. Other commenters suggested that EPA use lower discount rates as well as utilize the latest research and values from the December 2022 Supplemental Oil and Gas Proposal. EPA’s decision to use the updated SC–GHG values from U.S. EPA (2023f)<sup>1353</sup> addresses several of the concerns voiced within the comments. See RTC section 20 for further detail on the comments received and EPA’s responses. For a detailed description of

<sup>1351</sup> <https://www.epa.gov/environmental-economics/scghg-td-peer-review>.

<sup>1352</sup> Supplementary Material for the Regulatory Impact Analysis for the Final Rulemaking, “Standards of Performance for New, Reconstructed, and Modified Sources and Emissions Guidelines for Existing Sources: Oil and Natural Gas Sector Climate Review”, *EPA Report on the Social Cost of Greenhouse Gases: Estimates Incorporating Recent Scientific Advances*, Docket ID No. EPA–HQ–OAR–2021–0317, November 2023.

<sup>1353</sup> EPA. 2023f. “Supplementary Material for the Regulatory Impact Analysis for the Final Rulemaking: Standards of Performance for New, Reconstructed, and Modified Sources and Emissions Guidelines for Existing Sources: Oil and Natural Gas Sector Climate Review.” EPA Report on the Social Cost of Greenhouse Gases: Estimates Incorporating Recent Scientific Advances, Washington, DC. doi: Docket ID No. EPA–HQ–OAR–2021–0317.

<sup>1344</sup> U.S. EPA. (2023f).

the updated modeling, please see RIA section 7 for our final rule as well as the U.S. EPA (2023f). An appendix to Chapter 7 provides the climate benefits of the rule using the interim SC-GHG estimates.

Table VII-1 presents the annual, undiscounted monetized climate benefits of the net GHG emissions

reductions (comprised of GHG emissions reductions from vehicles and refineries, and increased GHG emissions from EGUs; see preamble section V) associated with the final rule using the SC-GHG estimates presented in EPA (2023f) for the stream of years beginning with the first year of rule

implementation, 2027, through 2055. Also shown are the present values (PV) and equivalent annualized values (AV) associated with each of the three SC-GHG values. For a thorough discussion of the SC-GHG methodology, limitations and uncertainties, see Chapter 7 of the RIA.

**Table VII-1 Climate Benefits<sup>a</sup> from Reduction in GHG Emissions Associated with the Final Rule, Millions of 2022\$**

Calendar Year	Near-Term Ramsey Discount Rate		
	2.5%	2%	1.5%
2027	\$46	\$73	\$120
2028	\$100	\$160	\$270
2029	\$160	\$260	\$430
2030	\$210	\$330	\$550
2031	\$330	\$510	\$850
2032	\$500	\$770	\$1,300
2033	\$650	\$1,000	\$1,600
2034	\$780	\$1,200	\$2,000
2035	\$880	\$1,400	\$2,200
2036	\$2,000	\$3,100	\$4,900
2037	\$3,400	\$5,300	\$8,500
2038	\$5,100	\$7,900	\$13,000
2039	\$7,100	\$11,000	\$18,000
2040	\$9,400	\$15,000	\$23,000
2041	\$10,000	\$15,000	\$25,000
2042	\$11,000	\$16,000	\$26,000
2043	\$11,000	\$17,000	\$27,000
2044	\$11,000	\$17,000	\$28,000
2045	\$12,000	\$18,000	\$28,000
2046	\$12,000	\$19,000	\$29,000
2047	\$13,000	\$19,000	\$30,000
2048	\$13,000	\$20,000	\$31,000
2049	\$14,000	\$20,000	\$32,000
2050	\$14,000	\$21,000	\$32,000
2051	\$14,000	\$21,000	\$33,000
2052	\$14,000	\$21,000	\$33,000
2053	\$15,000	\$22,000	\$34,000
2054	\$15,000	\$22,000	\$34,000
2055	\$15,000	\$22,000	\$34,000
PV	\$130,000	\$220,000	\$390,000
AV	\$6,600	\$10,000	\$17,000

<sup>a</sup> Climate benefits are based on changes (reductions) in CO<sub>2</sub>, CH<sub>4</sub>, and N<sub>2</sub>O emissions and are calculated using three different estimates of the social cost of carbon (SC-CO<sub>2</sub>), the social cost of methane (SC-CH<sub>4</sub>), and the social cost of nitrous oxide (SC-N<sub>2</sub>O) (model average at 1.5-percent, 2-percent, and 2.5-percent Ramsey discount rates). See RIA Chapter 7.1 for more information. Annual benefits shown are undiscounted values.

**B. Non-GHG Health Benefits**

This section discusses the economic benefits from reductions in adverse health impacts resulting from non-GHG emission reductions that can be expected to occur as a result of the final CO<sub>2</sub> emission standards. GHG emissions are predominantly the byproduct of

fossil fuel combustion processes that also produce criteria and hazardous air pollutant emissions. The heavy-duty vehicles that are subject to the final CO<sub>2</sub> emission standards are also significant sources of mobile source air pollution such as directly-emitted PM, NO<sub>x</sub>, VOCs, CO, SO<sub>2</sub> and air toxics. Our

projected emission reductions, monetized here, reflect the projected potential compliance pathway presented in preamble section II. However, as noted elsewhere, there are other means of achieving the standards, including pathways not utilizing ZEV technologies. Resulting emission

reductions would differ from those presented here in such cases (EPA expects that different manufacturers will choose different compliance pathways). Under the modeled potential compliance pathway, zero-emission technologies will also affect emissions from upstream sources that occur during, for example, electricity generation and from the refining and distribution of liquid fuel (see section V of this preamble). This final rule's benefits analysis includes added emissions due to increased electricity generation and emissions reductions from reduced petroleum refining.

Changes in ambient concentrations of ozone, PM<sub>2.5</sub>, and air toxics that will result from the final CO<sub>2</sub> emission standards under the modeled pathway are expected to affect human health by reducing premature deaths and other serious human health effects, and they are also expected to result in other important improvements in public health and welfare (see section VI of this preamble). Children, especially, benefit from reduced exposures to criteria and toxic pollutants because they tend to be more sensitive to the effects of these respiratory pollutants. Ozone and particulate matter have been associated with increased incidence of asthma and other respiratory effects in children, and particulate matter has been associated with a decrease in lung maturation.

When feasible, EPA conducts full-scale photochemical air quality modeling to demonstrate how its national mobile source regulatory actions affect ambient concentrations of regional pollutants throughout the United States. The estimation of the human health impacts of a regulatory action requires national-scale photochemical air quality modeling to conduct a full-scale assessment of PM<sub>2.5</sub>- and ozone-related health benefits. Air quality modeling and associated analyses are not available for this rule.

For the analysis of the final CO<sub>2</sub> emission standards (and the analysis of the alternative in section IX), we instead use a reduced-form "benefit-per-ton" (BPT) approach to estimate the monetized PM<sub>2.5</sub>-related health benefits of this final rule. The BPT approach estimates the monetized economic value of PM<sub>2.5</sub>-related emission impacts (such as direct PM, NO<sub>x</sub>, and SO<sub>2</sub>) due to implementation of the final program. Similar to the SC-GHG approach for monetizing reductions in GHGs, the

BPT approach estimates monetized health benefits of avoiding one ton of PM<sub>2.5</sub>-related emissions from a particular source sector. The value of health benefits from reductions or increases in PM<sub>2.5</sub> emissions associated with this final rule was estimated by multiplying PM<sub>2.5</sub>-related BPT values by the corresponding annual reduction in tons of directly-emitted PM<sub>2.5</sub> and PM<sub>2.5</sub> precursor emissions (NO<sub>x</sub> and SO<sub>2</sub>). As explained in Chapter 7.2 in the RIA, the PM<sub>2.5</sub> BPT values represent the monetized value of human health benefits, including reductions in both premature mortality and nonfatal illnesses.

The mobile sector BPT estimates used in this final rule were published in 2019 but have been updated to be consistent with the health benefits Technical Support Document (Benefits TSD) that accompanied the 2023 p.m. NAAQS Proposal.<sup>1354 1355 1356 1357</sup> The Benefits TSD details the approach used to estimate the PM<sub>2.5</sub>-related benefits reflected in these BPTs. The EGU and Refinery BPT estimates used in this final rule were also recently updated to be consistent with the Benefits TSD.<sup>1358</sup> For more detailed information about the benefits analysis conducted for this final rule, including the BPT unit values used in this analysis, please refer to Chapter 7 of the RIA.

A chief limitation to using PM<sub>2.5</sub>-related BPT values is that they do not reflect the health benefits associated with reducing ambient concentrations of ozone. The PM<sub>2.5</sub>-related BPT values also do not capture the health benefits

associated with reductions in direct exposure to NO<sub>2</sub> and mobile source air toxics, nor do they account for improved ecosystem effects or visibility. The estimated benefits of this final rule would be larger if we were able to monetize these unquantified benefits at this time.

Table VII-2 presents the annual, undiscounted PM<sub>2.5</sub>-related health benefits estimated for the stream of years beginning with the first year of rule implementation, 2027, through calendar year 2055 for the final standards. Benefits are presented by source: Onroad heavy-duty vehicles and upstream sources (EGUs and refineries combined). Because premature mortality typically constitutes the vast majority of monetized benefits in a PM<sub>2.5</sub> benefits assessment, we present benefits based on risk estimates reported from two different long-term exposure studies using different cohorts to account for uncertainty in the benefits associated with avoiding PM-related premature deaths.<sup>1359 1360</sup> Although annual benefits presented in the table are not discounted for the purposes of present value or annualized value calculations, annual benefits do reflect the use of 3-percent and 7-percent discount rates to account for avoided health outcomes that are expected to accrue over more than a single year (the "cessation lag" between the change in PM exposures and the total realization of changes in health effects). Table VII-2 also displays the present and annualized values of estimated benefits that occur from 2027 to 2055, discounted using both 3-percent and 7-percent discount rates and reported in 2022\$. We estimate that the annualized value of the benefits of the final program is \$120 to \$220 million at a 3-percent discount rate and –\$9.1 to –\$32 million at a 7-percent discount rate (2022\$). Depending on the discount rate used, the annualized value of the stream of PM<sub>2.5</sub> health benefits may either be positive or negative.

**BILLING CODE 6560-50-P**

<sup>1354</sup> Wolfe, P.; Davidson, K.; Fulcher, C.; Fann, N.; Zawacki, M.; Baker, K. R. 2019. Monetized Health Benefits Attributable to Mobile Source Emission Reductions across the United States in 2025. *Sci. Total Environ.* 650, 2490–2498. Available at: <https://doi.org/10.1016/j.scitotenv.2018.09.273>.

<sup>1355</sup> U.S. Environmental Protection Agency (U.S. EPA). 2023. PM NAAQS Reconsideration Proposal RIA. EPA-HQ-OAR-2019-0587.

<sup>1356</sup> U.S. Environmental Protection Agency (U.S. EPA). 2023. Estimating PM<sub>2.5</sub>- and Ozone-Attributable Health Benefits. Technical Support Document (TSD) for the PM NAAQS Reconsideration Proposal RIA. EPA-HQ-OAR-2019-0587.

<sup>1357</sup> Note that the Final PM NAAQS Reconsideration RIA, released in February 2024, based its benefits analysis on the same Benefits TSD that accompanied the PM NAAQS Reconsideration proposal.

<sup>1358</sup> U.S. Environmental Protection Agency (U.S. EPA). 2023. Technical Support Document: Estimating the Benefit per Ton of Reducing Directly-Emitted PM<sub>2.5</sub>, PM<sub>2.5</sub> Precursors and Ozone Precursors from 21 Sectors.

<sup>1359</sup> Wu, X, Braun, D, Schwartz, J, Kioumourtzoglou, M and Dominici, F (2020). Evaluating the impact of long-term exposure to fine particulate matter on mortality among the elderly. *Science advances* 6(29): eaba5692.

<sup>1360</sup> Pope III, CA, Lefler, JS, Ezzati, M, Higbee, JD, Marshall, JD, Kim, S-Y, Bechle, M, Gilliat, KS, Vernon, SE and Robinson, AL (2019). Mortality risk and fine particulate air pollution in a large, representative cohort of US adults. *Environmental health perspectives* 127(7): 077007.

**Table VII-2 Year-Over-Year Monetized PM<sub>2.5</sub>-Related Health Benefits<sup>a</sup> of the Final Program (millions, 2022\$)**

	Onroad Heavy-Duty Vehicles		Upstream Sources		Total Benefits	
	3% Discount Rate	7% Discount Rate	3% Discount Rate	7% Discount Rate	3% Discount Rate	7% Discount Rate
2027	\$3.9-8.2	\$3.5-7.4	\$(8.2)-(17)	\$(7.4)-(15)	\$(4.3)-(9.0)	\$(3.9)-(8.1)
2028	\$8.9-19	\$8.0-17	\$(23)-(47)	\$(20)-(43)	\$(14)-(29)	\$(12)-(26)
2029	\$15-31	\$13-28	\$(44)-(92)	\$(40)-(82)	\$(29)-(61)	\$(26)-(54)
2030	\$25-51	\$22-46	\$(99)-(200)	\$(89)-(180)	\$(74)-(150)	\$(67)-(140)
2031	\$48-98	\$43-88	\$(220)-(460)	\$(200)-(410)	\$(180)-(360)	\$(160)-(320)
2032	\$89-180	\$80-160	\$(460)-(940)	\$(420)-(850)	\$(370)-(760)	\$(340)-(690)
2033	\$130-270	\$120-240	\$(710)-(1,400)	\$(640)-(1,300)	\$(580)-(1,200)	\$(520)-(1,100)
2034	\$180-360	\$160-320	\$(970)-(2,000)	\$(870)-(1,800)	\$(790)-(1,600)	\$(710)-(1,400)
2035	\$230-460	\$210-420	\$(1,200)-(2,500)	\$(1,100)-(2,200)	\$(1,000)-(2,000)	\$(900)-(1,800)
2036	\$290-580	\$260-520	\$(1,200)-(2,500)	\$(1,100)-(2,200)	\$(930)-(1,900)	\$(840)-(1,700)
2037	\$360-720	\$320-640	\$(1,100)-(2,200)	\$(1,000)-(2,000)	\$(750)-(1,500)	\$(680)-(1,400)
2038	\$440-870	\$390-780	\$(900)-(1,800)	\$(810)-(1,600)	\$(470)-(940)	\$(420)-(840)
2039	\$510-1,000	\$460-910	\$(610)-(1,200)	\$(550)-(1,100)	\$(96)-(190)	\$(87)-(170)
2040	\$580-1,200	\$520-1,000	\$(230)-(450)	\$(200)-(400)	\$360-710	\$320-640
2041	\$650-1,300	\$580-1,200	\$(210)-(420)	\$(190)-(380)	\$440-860	\$390-770
2042	\$710-1,400	\$640-1,300	\$(200)-(390)	\$(180)-(350)	\$510-1,000	\$460-910
2043	\$760-1,500	\$690-1,400	\$(180)-(350)	\$(160)-(320)	\$590-1,200	\$530-1,000
2044	\$810-1,600	\$730-1,400	\$(150)-(300)	\$(140)-(270)	\$660-1,300	\$590-1,200
2045	\$850-1,700	\$770-1,500	\$(130)-(250)	\$(110)-(220)	\$730-1,400	\$650-1,300
2046	\$880-1,700	\$800-1,600	\$(110)-(220)	\$(100)-(200)	\$770-1,500	\$690-1,400
2047	\$910-1,800	\$820-1,600	\$(99)-(200)	\$(89)-(180)	\$810-1,600	\$730-1,400
2048	\$940-1,800	\$840-1,600	\$(84)-(170)	\$(76)-(150)	\$850-1,700	\$770-1,500
2049	\$960-1,900	\$860-1,700	\$(70)-(140)	\$(62)-(120)	\$890-1,700	\$800-1,600
2050	\$980-1,900	\$880-1,700	\$(55)-(110)	\$(49)-(97)	\$920-1,800	\$830-1,600
2051	\$1,000-1,900	\$900-1,700	\$(55)-(110)	\$(49)-(98)	\$940-1,800	\$850-1,600
2052	\$1,000-2,000	\$910-1,800	\$(56)-(110)	\$(50)-(99)	\$960-1,900	\$860-1,700
2053	\$1,000-2,000	\$930-1,800	\$(56)-(110)	\$(50)-(99)	\$970-1,900	\$880-1,700
2054	\$1,000-2,000	\$940-1,800	\$(56)-(110)	\$(50)-(100)	\$990-1,900	\$890-1,700
2055	\$1,100-2,000	\$950-1,800	\$(56)-(110)	\$(51)-(100)	\$1,000-1,900	\$900-1,700
Present Value	\$9,100-18,000	\$4,000-7,900	\$(6,800)-(14,000)	\$(4,100)-(8,300)	\$2,300-4,200	\$(110)-(400)
Annualized Value	\$480-930	\$330-650	\$(350)-(710)	\$(340)-(680)	\$120-220	\$(9.1)-(32)

<sup>a</sup> The range of benefits in this table reflect the range of premature mortality estimates derived from the Medicare study (Wu et al., 2020) and the NHIS study (Pope et al., 2019), respectively. All benefits estimates are rounded to two significant figures. Annual benefit values presented here are not discounted. Negative values in parentheses are health disbenefits related to increases in estimated emissions. The present value of benefits is the total aggregated value of the series of discounted annual benefits that occur between 2027-2055 (in 2022\$) using either a 3% or 7% discount rate. Depending on the discount rate used, the present and annualized value of the stream of PM<sub>2.5</sub> health benefits may either be positive or negative. The upstream impacts associated with the standards presented here include health benefits associated with reduced criteria pollutant emissions from refineries and health disbenefits associated with increased criteria pollutant emissions from EGUs. The benefits in this table also do not include the full complement of health and environmental benefits (such as health benefits related to reduced ozone exposure) that, if quantified and monetized, would increase the total monetized benefits.

**BILLING CODE 6560-50-C**

We use a constant 3-percent and 7-percent discount rate to calculate present and annualized values in Table

VII-2, consistent with current applicable OMB Circular No. A-4 guidance. For the purposes of

presenting total net benefits (see preamble section VIII), we also use a constant 2-percent discount rate to

calculate present and annualized values. We note that we do not currently have BPT estimates that use a 2-percent discount rate to account for cessation lag. If we apply a constant 2-percent discount rate to the stream of annual benefits based on the 3-percent cessation lag BPT, the annualized value of total PM<sub>2.5</sub>-related benefits would be \$160 to \$300 million.

We believe the non-GHG pollutant benefits presented here are our best estimate of benefits absent air quality modeling, and we have confidence that the BPT approach provides a reasonable estimate of the monetized PM<sub>2.5</sub>-related health benefits associated with this rulemaking. Please refer to RIA Chapter 7 for more information on the uncertainty associated with the benefits presented here.

### C. Energy Security

The final CO<sub>2</sub> emission standards are designed to require reductions in GHG emissions from HD vehicles in the MYs 2027–2032 and beyond timeframe and, thereby, are expected to reduce oil consumption. Our modeled potential compliance pathway projects a mix of ZEV technologies and ICE vehicle technologies in compliant fleets. Our analysis is based on this modeled potential compliance pathway but, as noted, many other potential pathways to compliance exist, and analytic results would differ from those presented here in such cases. Under our modeled compliance pathway, the standards will be met through a combination of zero-emission and ICE vehicle technologies, which will, in turn, reduce the demand for oil and enable the U.S. to reduce its petroleum imports. A reduction of U.S. petroleum imports reduces both financial and strategic risks caused by potential sudden disruptions in the supply of imported petroleum to the United States, thus increasing U.S. energy security.

Energy security is broadly defined as the uninterrupted availability of energy sources at affordable prices.<sup>1361</sup> Energy independence and energy security are distinct but related concepts. The goal of U.S. energy independence is the elimination of all U.S. imports of petroleum and other foreign sources of energy, but more broadly, it is the elimination of the U.S.’s sensitivity to variations in the price and supply of foreign sources of energy.<sup>1362</sup> See

Chapter 7 of the RIA for a more detailed assessment of energy security and energy independence impacts of this final rule and section II.D.2 for a discussion on battery critical minerals and supply.

In order to understand the energy security implications of reducing U.S. net oil imports, EPA has worked with Oak Ridge National Laboratory (ORNL), which has developed approaches for evaluating the social costs and energy security implications of oil use. When conducting this analysis, ORNL estimates the risk of reductions in U.S. economic output and disruption to the U.S. economy caused by sudden disruptions in world oil supply and associated price shocks (*i.e.*, labeled the avoided macroeconomic disruption/adjustment costs). These risks are quantified as “macroeconomic oil security premiums,” *i.e.*, the extra costs of oil use besides its market price.

Two commenters claimed that the proposed rule would improve the U.S.’s energy security position by increasing the wider use of electric HD vehicles. We agree with these commenters that the final rule will lower the risks to the U.S. economy of oil supply disruptions; our projected potential compliance pathway for the final standards supports that U.S. oil consumption and U.S. oil imports are reduced (*e.g.*, with the utilization of HD vehicle technologies including ZEV technologies) as a result of this final rule. On the other hand, several commenters suggested that EPA is undermining U.S. energy security by promoting electric HD vehicles in this proposed rule. Mandating a specific technology such as electric vehicles stifles innovation and progress, according to these commenters. We respond to these comments in detail in section 22 of the RTC but note here that the commenters’ characterization of the rule as mandating ZEV technology is not correct. While the potential compliance pathway that supports the feasibility of the final standards includes ZEV technologies in its mix of HD vehicle technologies, manufacturers can choose any compliance pathway most suitable to them and alternative compliance pathways exist, including those not involving ZEV technologies (see section II.F.6 of this preamble for one example). EPA thus believes that the final rule maintains the flexible structure created and followed in the previous HD vehicle GHG emission standards rules, which is effectively designed to reflect the diverse nature of the heavy-duty vehicle industry.

One commenter asserted that the proposed rule does not address the U.S. energy security impacts of the greater

use of natural gas in the U.S. electricity sector stemming from the wider use of electric HD vehicles as a result of this rule. We do not agree that this final rule will result in energy security issues stemming from the wider use of natural gas. We respond to this comment in section 22 of the RTC document.

One commenter suggested that the energy security methodology developed by ORNL used in the proposed rule is outdated and no longer applicable to the current structure of global oil markets. EPA and ORNL have worked together to revise the macroeconomic oil security premiums based upon the recent energy security literature. Also, for this final rule, EPA is using macroeconomic oil security premiums estimated using ORNL’s methodology which incorporates updated oil price projections and energy market and economic trends from the U.S. Department of Energy’s Energy Information Administration’s (EIA) most recent Annual Energy Outlook (AEO) 2023. Therefore, EPA believes that the macroeconomic oil security premiums used in this final rulemaking are reasonable. See section 22 of the RTC document for more discussion on this topic. We do not consider military cost impacts as a result of reductions in U.S. oil imports from this final rule due to methodological issues in quantifying these impacts.

To calculate the oil security benefits of this final rule, EPA is using the ORNL macroeconomic oil security premium methodology with (1) estimated oil savings calculated by EPA, and (2) an oil import reduction factor of 94.8 percent, which estimates how much U.S. oil net imports are reduced from projected changes in U.S. oil consumption. Estimated oil savings are discussed in detail in RIA Chapter 6.5. The oil import reduction factor is based on AEO data and is discussed in detail in RIA Chapter 7.3. Based upon consideration of comments EPA received on the proposal, EPA is updating the oil import reduction factor to be consistent with revised estimates that U.S. refineries will operate at higher production levels than EPA estimated in the proposed rule. See Chapter 4 of the RIA and section 13 of the RTC document for more discussion of how EPA is updating its refinery throughput assumptions and, in turn, air quality impacts from refinery emissions, as a result of this rule. See Chapter 7 of the RIA and section 22 of the RTC document for EPA’s discussion of how EPA is updating the oil import reduction factor to be consistent with new estimates of refinery throughput for this final rule. In Table VII–3, EPA

<sup>1361</sup> International Energy Agency. “Energy security: Ensuring the uninterrupted availability of energy sources at an affordable price”. Last updated December 2, 2019.

<sup>1362</sup> Greene, D. 2010. Measuring energy security: Can the United States achieve oil independence? *Energy Policy* 38, pp. 1614–1621.

presents the macroeconomic oil security vehicle standards for the years from 2027–2055.  
 premiums and the energy security benefits for the final HD GHG Phase 3

**Table VII-3 Macroeconomic Oil Security Premiums (in 2022\$/barrel) and Energy Security Benefits (in millions of 2022\$) with the Final HD GHG Phase 3 Rule**

Calendar Year	Macroeconomic Oil Security Premiums (range) <sup>a</sup>	Energy Security Benefits
2027	\$3.73 (\$0.51 - \$7.02)	\$4
2028	\$3.78 (\$0.51 - \$7.15)	\$10
2029	\$3.87 (\$0.54 - \$7.31)	\$18
2030	\$3.92 (\$0.51 - \$7.46)	\$32
2031	\$4.00 (\$0.55 - \$7.62)	\$65
2032	\$4.05 (\$0.53 - \$7.77)	\$120
2033	\$4.11 (\$0.47 - \$7.93)	\$180
2034	\$4.16 (\$0.44 - \$8.07)	\$240
2035	\$4.22 (\$0.45 - \$8.20)	\$300
2036	\$4.28 (\$0.44 - \$8.29)	\$360
2037	\$4.35 (\$0.47 - \$8.40)	\$410
2038	\$4.44 (\$0.52 - \$8.55)	\$460
2039	\$4.50 (\$0.53 - \$8.66)	\$510
2040	\$4.62 (\$0.65 - \$8.85)	\$560
2041	\$4.73 (\$0.70 - \$9.04)	\$600
2042	\$4.77 (\$0.69 - \$9.15)	\$640
2043	\$4.82 (\$0.67 - \$9.27)	\$670
2044	\$4.85 (\$0.66 - \$9.35)	\$690
2045	\$4.91 (\$0.68 - \$9.43)	\$720
2046	\$4.98 (\$0.71 - \$9.52)	\$740
2047	\$5.09 (\$0.82 - \$9.68)	\$760
2048	\$5.14 (\$0.85 - \$9.79)	\$770
2049	\$5.16 (\$0.82 - \$9.85)	\$780
2050	\$5.22 (\$0.91 - \$9.89)	\$790
2051 <sup>b</sup>	\$5.22 (\$0.91 - \$9.89)	\$800
2052 <sup>b</sup>	\$5.22 (\$0.91 - \$9.89)	\$800
2053 <sup>b</sup>	\$5.22 (\$0.91 - \$9.89)	\$800
2054 <sup>b</sup>	\$5.22 (\$0.91 - \$9.89)	\$800
2055 <sup>b</sup>	\$5.22 (\$0.91 - \$9.89)	\$800
PV, 2%	-	\$9,800
PV, 3%	-	\$8,200
PV, 7%	-	\$4,200
AV, 2%	-	\$450
AV, 3%	-	\$430
AV, 7%	-	\$340

<sup>a</sup> The first values listed in each cell are the midpoints; the values in parentheses are the 90 percent confidence intervals.

<sup>b</sup> Annual oil security premiums are estimated using data from Annual Energy Outlook projections, which are only available through 2050. For the years 2051 through 2055, we use the 2050 premium estimates as a proxy.

Two commenters claimed that since the proposed rule promotes the wider use of electric vehicles, it limits the potential for renewable fuels (i.e., biofuels) to create energy security benefits. One commenter suggested that proposed rule would make it more difficult to meet the renewable fuel mandates of EPA’s Renewable Fuel

Standard (RFS) program. EPA agrees with the commenters that the increased use of renewable fuels in the U.S. transportation sector will improve the U.S.’s energy security and energy independence position but disagrees that this rule is at odds with the RFS program. On June 21st, 2023, EPA announced a final rule (RFS Set Rule) to

establish renewable fuel volume requirements and associated percentage standards for cellulosic biofuel, biomass-based diesel, advanced biofuels, and total renewable fuel for the

2023–2025 timeframe.<sup>1363</sup> The recently finalized RFS Set Rule and this final rule are complementary in achieving GHG reductions in the U.S. transportation sector. We respond to these comments in more detail in section 22 of the RTC document.

Numerous commenters suggested that EPA ignored the impacts on U.S.’s energy and national security in the proposed rule of an unfavorable transition from reliable, abundant, domestically-sourced fuels to a complex supply chain reliant on foreign-sourced critical minerals. For this final rule, EPA distinguishes between energy security, mineral/metal security and security issues associated with the importation of critical minerals, ZEV batteries and component parts (*i.e.*, ZEV supply chain issues). We address energy security issues involving U.S. oil consumption and oil imports associated with this final rule in Chapter 7 of the RIA and section 22 of the RTC. Comments associated with projected wider use of HD ZEV technologies’ impacts on the U.S.’s mineral/metal security and security issues associated with the importation of HD ZEV batteries and their component parts (*i.e.*, ZEV technologies supply chain issues) are addressed in section II.D.2 of this preamble and in section 17 of the RTC document.

**VIII. Comparison of Benefits and Costs**

This section compares the estimated range of benefits associated with reductions of GHGs, monetized health benefits from reductions in PM<sub>2.5</sub>, energy security benefits, fuel savings, and vehicle-related operating savings to total costs associated with the modeled compliance pathway for the final rule and for the alternative. Estimated costs are detailed and presented in section IV

<sup>1363</sup> Renewable Fuel Standard (RFS) Program: Standards for 2023–2025 and Other Changes. 88 FR 44468, July 12, 2023.

of this preamble. Those costs include costs for both the new technology in our modeled potential compliance pathway’s technology packages and the operating costs associated with that new technology. Importantly, as detailed in section IV of this preamble, the vehicle costs presented here exclude the IRA battery tax credit, the vehicle tax credit and the EVSE tax credit while the fuel savings exclude fuel taxes. As such, as presented in this section, these costs, along with other operating costs, represent the social costs and/or savings associated with the final standards. Benefits from the reduction of GHG emissions and criteria pollutant emissions, and energy security benefits associated with reductions of imported oil, are presented in section VII.

**A. Methods**

EPA presents three different benefit-cost comparisons for the final rule and for the alternative:

1. A future-year snapshot comparison of annual benefits and costs in the year 2055, chosen to approximate the annual costs and benefits that will occur in a year when most of the regulated fleet will consist of HD vehicles subject to the HD GHG Phase 3 standards due to fleet turnover. Benefits, costs, and net benefits are presented in year 2022 dollars and are not discounted.

2. The present value (PV) of the stream of benefits, costs, and net benefits calculated for the analytical time horizon of 2027 through 2055, discounted back to the first year of implementation of the final rule (2027) using 2-percent, 3-percent and 7-percent discount rates, and presented in year 2022 dollars.<sup>1364</sup> Note that year-over-

<sup>1364</sup> Monetized climate benefits are presented under a 2 percent near-term Ramsey discount rate, consistent with EPA’s updated estimates of the SC–GHG. The 2003 version of OMB’s Circular A–4 had generally recommended 3 percent and 7 percent as default discount rates for costs and benefits, though as part of the Interagency Working Group on the Social Cost of Greenhouse Gases, OMB had also

year costs are presented in preamble section IV and year-over-year benefits may be found in preamble section VII.

3. The equivalent annualized value (AV) of benefits, costs, and net benefits representing a flow of constant annual values that, had they occurred in each year from 2027 through 2055, will yield an equivalent present value to those estimated in method 2 (using a 2-percent, 3-percent or 7-percent discount rate). Each AV represents a typical benefit, cost, or net benefit for each year of the analysis and is presented in year 2022 dollars.

**B. Results**

Table VIII–1 shows the undiscounted annual monetized vehicle-related projected technology packages RPE costs of the final rule and the alternative in calendar year 2055. The table also shows the PV and AV of those costs for the calendar years 2027 through 2055 using 2-percent, 3-percent and 7-percent discount rates. The table includes an estimate of the projected vehicle technology packages RPE costs and corresponding costs associated with EVSE.

Note that all costs, savings, and benefits estimates presented in the tables that follow are rounded to two significant figures; numbers may not sum due to independent rounding.

long recognized that climate effects should be discounted only at appropriate consumption-based discount rates. While we were conducting the analysis for this rule, OMB finalized an update to Circular A–4, in which it recommended the general application of a 2 percent discount rate to costs and benefits (subject to regular updates), as well as the consideration of the shadow price of capital when costs or benefits are likely to accrue to capital (OMB 2023). Because the SC–GHG estimates reflect net climate change damages in terms of reduced consumption (or monetary consumption equivalents), the use of the social rate of return on capital (7 percent under OMB Circular A–4 (2003)) to discount damages estimated in terms of reduced consumption would inappropriately underestimate the impacts of climate change for the purposes of estimating the SC–GHG.

**Table VIII-1 Vehicle-Related Technology Costs Associated with the Final Rule and Alternative, Millions of 2022\$**

	Final Rule			Alternative		
	Vehicle Technology Package RPE	EVSE RPE	Sum	Vehicle Technology Package RPE	EVSE RPE	Sum
2055	-\$590	\$1,100	\$550	\$55	\$79	\$130
PV, 2%	-\$4,200	\$28,000	\$24,000	\$3,000	\$5,000	\$8,000
PV, 3%	-\$3,200	\$25,000	\$22,000	\$2,600	\$4,600	\$7,200
PV, 7%	-\$1,000	\$15,000	\$14,000	\$1,700	\$3,400	\$5,000
AV, 2%	-\$190	\$1,300	\$1,100	\$140	\$230	\$370
AV, 3%	-\$170	\$1,300	\$1,100	\$140	\$240	\$380
AV, 7%	-\$83	\$1,300	\$1,200	\$140	\$270	\$410

**Table VIII-2 Vehicle-Related Operating Savings Associated with the Final Rule, Millions of 2022\$<sup>a</sup>**

	Pre-tax Fuel Savings	DEF Savings	Maintenance & Repair Savings	Insurance Savings	Vehicle Replacement Savings	EVSE Replacement Savings	Sum of Savings
2055	-\$350	\$1,800	\$6,900	\$250	\$140	-\$1,300	\$7,400
PV, 2%	-\$9,500	\$21,000	\$73,000	\$1,300	\$1,900	-\$11,000	\$76,000
PV, 3%	-\$7,900	\$17,000	\$60,000	\$1,000	\$1,500	-\$8,700	\$63,000
PV, 7%	-\$3,900	\$8,700	\$30,000	\$460	\$720	-\$3,700	\$32,000
AV, 2%	-\$430	\$950	\$3,300	\$60	\$86	-\$500	\$3,500
AV, 3%	-\$410	\$900	\$3,100	\$55	\$80	-\$450	\$3,300
AV, 7%	-\$310	\$710	\$2,400	\$38	\$58	-\$300	\$2,600

<sup>a</sup> Fuel savings are net of savings in diesel, gasoline, and CNG consumption with increased electricity and hydrogen consumption; DEF savings accrue only to diesel vehicles; maintenance and repair savings include impacts associated with all fuels; replacement savings are net of costs associated with replacement/rebuild of liquid-fueled engines and replacement of batteries on electric vehicles.

Table VIII-2 and Table VIII-3 show the undiscounted annual monetized vehicle-related operating savings of the final rule and the alternative, respectively, in calendar year 2055. The table also shows the PV and AV of those savings for calendar years 2027 through 2055 using 2-percent, 3-percent and 7-percent discount rates. The savings in

diesel exhaust fluid (DEF) consumption arise in the modeled potential compliance pathway's technology packages from the decrease in diesel engine-equipped vehicles which require DEF to maintain compliance with NOx emission standards. The maintenance and repair savings are due again to the HD vehicle technologies utilized in the

modeled potential compliance pathway; BEVs and FCEVs are projected to ultimately require 71 percent and 75 percent, respectively, of the maintenance and repair costs required of HD vehicles equipped with internal combustion engines, as discussed in section II.



**Table VIII-3 Vehicle-Related Operating Savings Associated with the Alternative, Millions of 2022\$<sup>a</sup>**

	Pre-tax Fuel Savings	DEF Savings	Maintenance & Repair Savings	Insurance Savings	Vehicle Replacement Savings	EVSE Replacement Savings	Sum of Savings
2055	-\$1,300	\$580	\$2,000	-\$78	\$44	-\$130	\$1,100
PV, 2%	-\$16,000	\$7,500	\$25,000	-\$830	\$710	-\$2,700	\$13,000
PV, 3%	-\$13,000	\$6,200	\$21,000	-\$680	\$590	-\$2,200	\$11,000
PV, 7%	-\$6,500	\$3,200	\$10,000	-\$310	\$280	-\$1,000	\$6,100
AV, 2%	-\$750	\$340	\$1,100	-\$38	\$33	-\$120	\$600
AV, 3%	-\$700	\$330	\$1,100	-\$35	\$31	-\$110	\$580
AV, 7%	-\$530	\$260	\$850	-\$25	\$23	-\$81	\$490

<sup>a</sup> Fuel savings are net of savings in diesel, gasoline, and CNG consumption with increased electricity and hydrogen consumption; DEF savings accrue only to diesel vehicles; maintenance and repair savings include impacts associated with all fuels; replacement savings are net of costs associated with replacement/rebuild of liquid-fueled engines and replacement of batteries on electric vehicles.

Table VIII-4 shows the undiscounted annual monetized energy security benefits of the final rule and the

alternative in calendar year 2055. The table also shows the PV and AV of those benefits for calendar years 2027 through

2055 using 2-percent, 3-percent and 7-percent discount rates.

**Table VIII-4 Energy Security Benefits Associated with the Final Rule and Alternative, Millions of 2022\$**

	Final Rule	Alternative
2055	\$800	\$240
PV, 2%	\$9,800	\$3,400
PV, 3%	\$8,200	\$2,800
PV, 7%	\$4,200	\$1,500
AV, 2%	\$450	\$150
AV, 3%	\$430	\$150
AV, 7%	\$340	\$120

Table VIII-5 shows the climate benefits of reduced GHG emissions, using the SC-GHG estimates presented in the EPA Report on the Social Cost of Greenhouse Gases: Estimates Incorporating Recent Scientific Advances (EPA 2023).<sup>1365</sup> The details are discussed in RIA Chapter 7. These climate benefits include benefits associated with changes to HD vehicle GHGs and both EGU and refinery GHG emissions, but do not include any impacts associated with the extraction or transportation of fuels for either EGUs or refineries.

Table VIII-6 shows the undiscounted annual monetized PM<sub>2.5</sub>-related health benefits of the final rule and the alternative in calendar year 2055. The table also shows the PV and AV of those benefits for calendar years 2027 through 2055 using a 2-percent, 3-percent and 7-percent discount rate. The benefits in

Table VIII-6 reflect the two premature mortality estimates derived from the Medicare study (Wu et al., 2020) and the NHIS study (Pope et al., 2019).<sup>1366 1367</sup> The monetized criteria pollutant health benefits include reductions in PM<sub>2.5</sub>-related emissions from HD vehicles.

Monetized upstream health impacts associated with the standards also include benefits associated with reduced PM<sub>2.5</sub>-related emissions from refineries and health disbenefits associated with increased PM<sub>2.5</sub>-related emissions from EGUs. Negative monetized values are associated with health disbenefits related to increases in estimated emissions from EGUs. Depending on the discount rate used, the present and annualized value of the stream of PM<sub>2.5</sub>-related benefits may either be positive or negative.

<sup>1365</sup> For more information about the development of these estimates, see [www.epa.gov/environmental-economics/scghg](http://www.epa.gov/environmental-economics/scghg).

<sup>1366</sup> Wu, X, Braun, D, Schwartz, J, Kioumourtzoglou, M and Dominici, F (2020).

Evaluating the impact of long-term exposure to fine particulate matter on mortality among the elderly. Science advances 6(29): eaba5692.

<sup>1367</sup> Pope III, CA, Lefler, JS, Ezzati, M, Higbee, JD, Marshall, JD, Kim, S-Y, Bechle, M, Gilliat, KS,

Vernon, SE and Robinson, AL (2019). Mortality risk and fine particulate air pollution in a large, representative cohort of US adults. Environmental health perspectives 127(7): 077007.

**Table VIII-5 Climate Benefits<sup>a</sup> from Reduction in GHG Emissions Associated with the Final Rule and Alternative, Millions of 2022\$**

	Final Rule			Alternative		
	Near-term Ramsey Discount Rate			Near-term Ramsey Discount Rate		
	2.5%	2%	1.5%	2.5%	2%	1.5%
2055	\$15,000	\$22,000	\$34,000	\$4,300	\$6,400	\$9,800
PV	\$130,000	\$220,000	\$390,000	\$42,000	\$71,000	\$120,000
AV	\$6,600	\$10,000	\$17,000	\$2,100	\$3,200	\$5,300

<sup>a</sup> Climate benefits are based on changes (reductions) in CO<sub>2</sub>, CH<sub>4</sub>, and N<sub>2</sub>O emissions and are calculated using three different estimates of the social cost of carbon (SC-CO<sub>2</sub>), the social cost of methane (SC-CH<sub>4</sub>), and the social cost of nitrous oxide (SC-N<sub>2</sub>O) (model average at 1.5-percent, 2-percent, and 2.5-percent Ramsey discount rates). See RIA Chapter 7.1 for more information. Annual benefits shown are undiscounted values.

**Table VIII-6 Monetized PM<sub>2.5</sub>-Related Emission Benefits<sup>a</sup> Associated with the Final Rule and Alternative, Millions of 2022\$**

	Final Rule			Alternative		
	2%	3%	7%	2%	3%	7%
2055	\$1,000-1,900	\$1,000-1,900	\$900-1,700	\$270-520	\$270-520	\$240-470
PV	\$3,500-6,500	\$2,300-4,200	\$(110)-(400)	\$320-480	\$40-(58)	\$(440)-(950)
AV	\$160-300	\$120-220	\$(9.1)-(32)	\$15-22	\$2.1-(3.0)	\$(36)-(77)

<sup>a</sup> Monetized PM<sub>2.5</sub>-related health impacts are based on benefit-per-ton (BPT) values. The benefits in this table reflect two premature mortality estimates derived from the Medicare study (Wu et al., 2020) and the NHIS study (Pope III et al., 2019), respectively. Annual PM<sub>2.5</sub> BPT estimates use 3-percent and 7-percent discount rates to account for avoided health outcomes that are expected to accrue over more than a single year (the “cessation lag” between the change in PM exposures and the total realization of changes in health effects). We do not currently have BPT estimates that use a 2-percent discount rate to account for cessation lag; for this reason, annual benefits in 2055 are the same in the 2-percent and 3-percent columns.

All benefits estimates are rounded to two significant figures. The present value of benefits is the total aggregated value of the series of discounted annual benefits that occur between 2027-2055 (in 2022\$) using either a 2-percent, 3-percent or 7-percent discount rate.

Monetized criteria pollutant health benefits include reductions in PM<sub>2.5</sub>-related emissions from HD vehicles. Monetized upstream health impacts associated with the standards also include benefits associated with reduced PM<sub>2.5</sub>-related emissions from refineries and health disbenefits associated with increased PM<sub>2.5</sub>-related emissions from EGUs. Negative monetized values in parentheses are associated with health disbenefits related to increases in estimated emissions from EGUs. Depending on the discount rate used, the present and annualized value of the stream of PM<sub>2.5</sub> benefits may either be positive or negative.

The benefits in this table also do not include the full complement of health and environmental benefits (such as health benefits related to reduced ozone exposure) that, if quantified and monetized, would increase the total monetized benefits.

Table VIII-7 shows the undiscounted annual total benefits of the final rule and the alternative in calendar year 2055, as well as the PV and AV of the total benefits for calendar years 2027 through 2055. Total benefits are the sum of climate benefits, criteria pollutant benefits and energy security benefits. The present and annualized values of energy security benefits and PM<sub>2.5</sub> health impacts are discounted using either a 2-percent, 3-percent, or 7-

percent constant discount rate (see Table VIII-4 and Table VIII-6, respectively). Climate benefits are based on reductions in GHG emissions and are calculated using three different SC-GHG estimates that assume either a 1.5-percent, 2.0-percent, or 2.5-percent near-term Ramsey discount rate (see Table VIII-5). For presentational purposes in Table VIII-7, we use the climate benefits associated with the SC-GHG estimates at the 2-percent near-

term Ramsey discount rate for the total benefits calculation. The benefits include those associated with changes to HD vehicle GHGs and both EGU and refinery GHG emissions, but do not include any impacts associated with the extraction or transportation of fuels for either EGUs or refineries. This likely underestimates the refinery-related emission reductions projected in the rule but likely also underestimates EGU-related emission increases in the rule.

**Table VIII-7 Total Benefits Associated with the Final Rule and Alternative, Millions of 2022\$**

	Total Benefits	
	Final Rule	Alternative
2055	\$25,000	\$7,100
PV, 2%	\$240,000	\$75,000
PV, 3%	\$240,000	\$73,000
PV, 7%	\$230,000	\$71,000
AV, 2%	\$11,000	\$3,400
AV, 3%	\$11,000	\$3,400
AV, 7%	\$11,000	\$3,300

Notes:

Total benefits are the sum of climate benefits, PM<sub>2.5</sub>-related benefits and energy security benefits.

Climate benefits are based on reductions in GHG emissions and are calculated using three different SC-GHG estimates that assume either a 1.5-percent, 2.0-percent, or 2.5-percent near-term Ramsey discount rate (see Table VIII-5). For presentational clarity in this table, we use the climate benefits associated with the SC-GHG estimates at the 2-percent near-term Ramsey discount rate for the total benefits calculation.

The present and annualized values of energy security benefits and PM<sub>2.5</sub> health impacts are discounted using either a 2-percent, 3-percent, or 7-percent constant discount rate (see Table VIII-4 and Table VIII-6, respectively).

For presentational clarity, we use the monetized suite of total avoided PM<sub>2.5</sub>-related health effects that includes avoided deaths based on the Pope III et al., 2019 study, which is the larger of the two PM<sub>2.5</sub> health benefits estimates presented in section VII.B of this preamble.

All benefits estimates are rounded to two significant figures.

We summarize the vehicle costs, operational savings, and benefits of the final rule, as shown in Table VIII-8. Table VIII-8 presents the final rule's costs from Table VIII-1, operating savings from Table VIII-2, and total benefits from Table VIII-7 (comprised of

benefits presented in Tables VIII-4 through VIII-6) in a single table. We summarize the vehicle costs, operational savings, and benefits of the alternative in Table VIII-9. We remind readers that, in the NPRM, we used the interim SC-GHG values, while in this

final rule we are using the updated SC-GHG values (see section VII.A of this preamble and Chapter 7.1 of the final RIA). We include the 2 percent discount rate here for consistency with the 2 percent near-term Ramsey discount rate used in the updated SC-GHG values.

**Table VIII-8 Summary of Vehicle Costs, Operating Savings, and Benefits of the Final Rule, Billions of 2022\$**

	<b>CY 2055</b>	<b>PV, 2%</b>	<b>PV, 3%</b>	<b>PV, 7%</b>	<b>AV, 2%</b>	<b>AV, 3%</b>	<b>AV, 7%</b>
Vehicle Technology Package RPE	-\$0.59	-\$4.2	-\$3.2	-\$1	-\$0.19	-\$0.17	-\$0.083
EVSE RPE	\$1.1	\$28	\$25	\$15	\$1.3	\$1.3	\$1.3
Sum of Vehicle Costs	\$0.55	\$24	\$22	\$14	\$1.1	\$1.1	\$1.2
Pre-tax Fuel Savings	-\$0.35	-\$9.5	-\$7.9	-\$3.9	-\$0.43	-\$0.41	-\$0.31
Diesel Exhaust Fluid Savings	\$1.8	\$21	\$17	\$8.7	\$0.95	\$0.9	\$0.71
Repair & Maintenance Savings	\$6.9	\$73	\$60	\$30	\$3.3	\$3.1	\$2.4
Insurance Savings	\$0.25	\$1.3	\$1	\$0.46	\$0.06	\$0.055	\$0.038
Vehicle Replacement Savings	\$0.14	\$1.9	\$1.5	\$0.72	\$0.086	\$0.08	\$0.058
EVSE Replacement Savings	-\$1.3	-\$11	-\$8.7	-\$3.7	-\$0.5	-\$0.45	-\$0.3
Sum of Operating Savings	\$7.4	\$76	\$63	\$32	\$3.5	\$3.3	\$2.6
Energy Security Benefits	\$0.8	\$9.8	\$8.2	\$4.2	\$0.45	\$0.43	\$0.34
Climate Benefits – 2% Near-term Ramsey <sup>a</sup>	\$22	\$220	\$220	\$220	\$10	\$10	\$10
PM <sub>2.5</sub> Health Benefits <sup>b,c,d</sup>	\$1.9	\$6.5	\$4.2	-\$0.4	\$0.3	\$0.22	-\$0.032
Sum of Benefits	\$25	\$240	\$240	\$230	\$11	\$11	\$11
<b>Net Benefits<sup>e</sup></b>	<b>\$32</b>	<b>\$290</b>	<b>\$280</b>	<b>\$250</b>	<b>\$13</b>	<b>\$13</b>	<b>\$12</b>

<sup>a</sup> Climate benefits are based on reductions in GHG emissions and are calculated using three different SC-GHG estimates that assume either a 1.5 percent, 2.0 percent, or 2.5 percent near-term Ramsey discount rate. See EPA’s Report on the Social Cost of Greenhouse Gases: Estimates Incorporating Recent Scientific Advances (EPA, 2023). For presentational purposes in this table, we use the climate benefits associated with the SC-GHG under the 2-percent near-term Ramsey discount rate. See Table VIII-5 for the full range of monetized climate benefit estimates. All other costs and benefits are discounted using either a 2-percent, 3-percent, or 7-percent constant discount rate. For further discussion of the SC-GHGs and how EPA accounted for these estimates, please refer to Chapter 7 of the RIA that accompanies this preamble.

<sup>b</sup> Monetized non-GHG health benefits are based on PM<sub>2.5</sub>-related benefit-per-ton (BPT) values. To calculate net benefits, we use the monetized suite of total avoided PM<sub>2.5</sub>-related health effects that includes avoided deaths based on the Pope III et al., 2019 study, which is the larger of the two PM<sub>2.5</sub> health benefits estimates presented in section VII.B of this preamble.

<sup>c</sup> The annual PM<sub>2.5</sub> health benefits estimate presented in the CY 2055 column reflects the value of certain avoided health outcomes, such as avoided deaths, that are expected to accrue over more than a single year discounted using a 3-percent discount rate.

<sup>d</sup> We do not currently have year-over-year estimates of PM<sub>2.5</sub> benefits that discount such annual health outcomes using a 2-percent discount rate. We have therefore discounted the annual stream of health benefits that reflect a 3-percent discount rate lag adjustment using a 2-percent discount rate to populate the PV, 2% and AV, 2% columns. The annual stream of PM<sub>2.5</sub>-related health benefits that reflect a 3-percent and 7-percent discount rate lag adjustment were used to populate the PV/AV 3% and PV/AV 7% columns, respectively. See section VII.B of this preamble for more details on the annual stream of PM<sub>2.5</sub>-related benefits associated with this rule.

<sup>e</sup> Net benefits are the sum of benefits and operating savings minus vehicle costs.

**Table VIII-9 Summary of Vehicle Costs, Operating Savings, and Benefits of the Alternative, Billions of 2022\$**

	CY 2055	PV, 2%	PV, 3%	PV, 7%	AV, 2%	AV, 3%	AV, 7%
Vehicle Technology Package RPE	\$0.055	\$3	\$2.6	\$1.7	\$0.14	\$0.14	\$0.14
EVSE RPE	\$0.079	\$5	\$4.6	\$3.4	\$0.23	\$0.24	\$0.27
Sum of Vehicle Costs	\$0.13	\$8	\$7.2	\$5	\$0.37	\$0.38	\$0.41
Pre-tax Fuel Savings	-\$1.3	-\$16	-\$13	-\$6.5	-\$0.75	-\$0.7	-\$0.53
Diesel Exhaust Fluid Savings	\$0.58	\$7.5	\$6.2	\$3.2	\$0.34	\$0.33	\$0.26
Repair & Maintenance Savings	\$2	\$25	\$21	\$10	\$1.1	\$1.1	\$0.85
Insurance Savings	-\$0.078	-\$0.83	-\$0.68	-\$0.31	-\$0.038	-\$0.035	-\$0.025
Vehicle Replacement Savings	\$0.044	\$0.71	\$0.59	\$0.28	\$0.033	\$0.031	\$0.023
EVSE Replacement Savings	-\$0.13	-\$2.7	-\$2.2	-\$1	-\$0.12	-\$0.11	-\$0.081
Sum of Operating Savings	\$1.1	\$13	\$11	\$6.1	\$0.6	\$0.58	\$0.49
Energy Security Benefits	\$0.24	\$3.4	\$2.8	\$1.5	\$0.15	\$0.15	\$0.12
Climate Benefits – 2% Near-term Ramsey <sup>a</sup>	\$0.64	\$71	\$71	\$71	\$3.2	\$3.2	\$3.2
PM <sub>2.5</sub> Health Benefits <sup>b,c,d</sup>	\$0.52	\$0.48	-\$0.058	-\$0.95	\$0.022	-\$0.003	-\$0.077
Sum of Benefits	\$7.1	\$75	\$73	\$71	\$3.4	\$3.4	\$3.3
<b>Net Benefits</b>	<b>\$8.1</b>	<b>\$80</b>	<b>\$77</b>	<b>\$72</b>	<b>\$3.6</b>	<b>\$3.6</b>	<b>\$3.4</b>

<sup>a</sup> Climate benefits are based on reductions in GHG emissions and are calculated using three different SC-GHG estimates that assume either a 1.5-percent, 2.0-percent, or 2.5-percent near-term Ramsey discount rate. For presentational purposes in this table, we use the climate benefits associated with the SC-GHG estimates under the 2-percent near-term Ramsey discount rate. See Table VIII-5 for the full range of monetized climate benefit estimates. All other costs and benefits are discounted using either a 2-percent, 3-percent, or 7-percent constant discount rate.

<sup>b</sup> To calculate net benefits, we use the monetized suite of total avoided PM<sub>2.5</sub>-related health effects that includes avoided deaths based on the Pope III et al., 2019 study, which is the larger of the two PM<sub>2.5</sub> health benefits estimates presented in section VII.B of this preamble.

<sup>c</sup> The annual PM<sub>2.5</sub> health benefits estimate presented in the CY 2055 column reflects the value of certain avoided health outcomes, such as avoided deaths, that are expected to accrue over more than a single year discounted using a 3-percent discount rate.

<sup>d</sup> We do not currently have year-over-year estimates of PM<sub>2.5</sub> benefits that discount such annual health outcomes using a 2-percent discount rate. We have therefore discounted the annual stream of health benefits that reflect a 3-percent discount rate lag adjustment using a 2-percent discount rate to populate the PV, 2% and AV, 2% columns. The annual stream of PM<sub>2.5</sub>-related health benefits that reflect a 3-percent and 7-percent discount rate lag adjustment were used to populate the PV/AV 3% and PV/AV 7% columns, respectively. See section VII.B of this preamble for more details on the annual stream of PM<sub>2.5</sub>-related benefits associated with this rule.

We have also estimated the total transfers associated with the final standards and the alternative, as shown in Table VIII-10 and Table VIII-11, respectively. The transfers consist of the IRA battery tax credit, vehicle tax credit,

EVSE tax credit, fuel taxes, Federal excise taxes and state sales taxes, and annual vehicle registration fees on all ZEVs. None of these are included in the prior tables (*i.e.*, Table VIII-1 through Table VIII-9) in this section's

comparison of benefits and costs. Note that the transfers are presented from the perspective of purchasers, so positive values represent transfers to purchasers.

**Table VIII-10 Transfers Associated with the Final Rule, Millions of 2022\$**

	Battery Tax Credits	Vehicle Tax Credits	EVSE Tax Credits	Fuel Taxes	Federal Excise Taxes	State Sales Taxes	State Registration Fees on ZEVs	Sum
2055	\$0	\$0	\$0	\$3,400	-\$11	\$30	-\$230	\$3,200
PV, 2%	\$1,400	\$1,500	\$950	\$46,000	-\$990	\$280	-\$2,500	\$46,000
PV, 3%	\$1,300	\$1,400	\$910	\$38,000	-\$890	\$230	-\$2,100	\$39,000
PV, 7%	\$1,100	\$1,100	\$770	\$20,000	-\$580	\$110	-\$1,000	\$22,000
AV, 2%	\$63	\$67	\$43	\$2,100	-\$45	\$13	-\$110	\$2,100
AV, 3%	\$69	\$73	\$47	\$2,000	-\$46	\$12	-\$110	\$2,100
AV, 7%	\$92	\$93	\$63	\$1,600	-\$47	\$8.8	-\$85	\$1,800

**Table VIII-11 Transfers Associated with the Alternative, Millions of 2022\$**

	Battery Tax Credits	Vehicle Tax Credits	EVSE Tax Credits	Fuel Taxes	Federal Excise Taxes	State Sales Taxes	State Registration Fees on ZEVs	Sum
2055	\$0	\$0	\$0	\$990	-\$9.8	-\$2.8	-\$46	\$930
PV, 2%	\$670	\$700	\$400	\$16,000	-\$510	-\$120	-\$660	\$16,000
PV, 3%	\$650	\$670	\$380	\$13,000	-\$450	-\$99	-\$560	\$14,000
PV, 7%	\$550	\$550	\$330	\$7,100	-\$290	-\$56	-\$300	\$7,800
AV, 2%	\$31	\$32	\$18	\$710	-\$23	-\$5.3	-\$30	\$740
AV, 3%	\$34	\$35	\$20	\$680	-\$24	-\$5.2	-\$29	\$720
AV, 7%	\$45	\$45	\$27	\$570	-\$24	-\$4.6	-\$25	\$640

**IX. Analysis of Alternative CO<sub>2</sub> Emission Standards**

As discussed throughout this preamble, in developing this final rule, EPA considered a regulatory alternative that would establish less stringent CO<sub>2</sub> emission standards and, thus, would result in fewer GHG emission reductions than the CO<sub>2</sub> emission standards we are finalizing. This section presents estimates of technology costs, CO<sub>2</sub> emission reductions, fuel savings, and other impacts associated with the alternative.

*A. Comparison of Final Standards and Alternative*

The alternative represents a slower phase-in option for program

implementation, which represents differences in timing, costs, and benefits of a HD vehicle CO<sub>2</sub> emissions program. Specifically, the alternative has both a less aggressive phase-in of CO<sub>2</sub> emissions standards from MYs 2027 through 2031 and a less stringent standard for MYs 2032 and beyond. The alternative was modeled using the same methodologies used to model the final rule, as described in Chapters 2 and 4 of the RIA.

EPA developed and considered an alternative with a more gradual phase-in of CO<sub>2</sub> emission standards for MYs 2027 through MY 2031 and a less stringent final standard in MY 2032, as discussed in section II.H. The slower phase-in alternative standards,

presented in Table IX-1 and Table IX-2, are calculated using the same method as the final standards, as described in preamble section II.F. The ZEV technologies adoption rates in the potential technology packages that would comply with these levels of stringency for MYs 2027 through 2032 under the slower phase-in alternative are shown in Table IX-1. The ZEV technologies adoption rates in the potential technology packages that would comply with the slower phase-in alternative standards by regulatory subcategory and by MY are shown in RIA Chapter 2.9.5.

**Table IX-1 Alternative MY 2027 Through 2032+ Vocational Vehicle CO<sub>2</sub> Emission Standards (grams/ton-mile)**

Model Year	Subcategory	CI Light Heavy	CI Medium Heavy	CI Heavy Heavy	SI Light Heavy	SI Medium Heavy
2027	Urban	312	232	269	358	271
	Multi-Purpose	281	212	230	323	245
	Regional	247	196	189	275	225
2028	Urban	294	224	269	340	263
	Multi-Purpose	264	204	230	306	237
	Regional	233	190	189	261	219
2029	Urban	279	217	245	325	256
	Multi-Purpose	251	197	209	293	230
	Regional	221	183	172	249	212
2030	Urban	261	209	237	307	248
	Multi-Purpose	234	190	202	276	223
	Regional	207	177	166	235	206
2031	Urban	242	201	231	288	240
	Multi-Purpose	218	183	198	260	216
	Regional	192	170	163	220	199
2032 and later	Urban	228	194	223	274	233
	Multi-Purpose	205	176	191	247	209
	Regional	180	164	157	208	193

**Table IX-2 Alternative MY 2027 Through MY 2032+ Tractor CO<sub>2</sub> Emission Standards (grams/ton-mile)**

Model Year	Roof Height	Class 7 All Cab Styles	Class 8 Day Cab	Class 8 Sleeper Cab
	Low Roof	96.2	73.4	64.1
	Mid Roof	103.4	78.0	69.6
	High Roof	100.0	75.7	64.3
2028	Low Roof	89.5	68.3	64.1
	Mid Roof	96.2	72.5	69.6
	High Roof	93.0	70.4	64.3
2029	Low Roof	86.6	66.1	64.1
	Mid Roof	93.1	70.2	69.6
	High Roof	90.0	68.1	64.3
2030	Low Roof	82.7	63.1	60.9
	Mid Roof	88.9	67.1	66.1
	High Roof	86.0	65.1	61.1
2031	Low Roof	79.8	60.9	57.7
	Mid Roof	85.8	64.7	62.6
	High Roof	83.0	62.8	57.9
2032 and later	Low Roof	76.0	58.0	54.5
	Mid Roof	81.7	61.6	59.2
	High Roof	79.0	59.8	54.7

Based on our current analysis for each of the vocational vehicle and tractor subcategories, our assessment is that feasible and appropriate emission standards that provide for greater CO<sub>2</sub> emission reductions than through the slower phase-in alternative and at reasonable cost are available. As explained in preamble section II.H, we are not adopting this alternative set of standards in this final rule because, as already described, our assessment is that feasible and appropriate standards

are available that provide for greater emission reductions than provided under this alternative, do so at reasonable cost, and provide sufficient lead time.

*B. Emission Inventory Comparison of Final Rule and Slower Phase-In Alternative*

Both the final standards and the alternative were modeled by EPA in an updated version of EPA’s Motor Vehicle Emission Simulator (MOVES) model,

MOVES4.R3 by increasing ZEV adoption in HD vehicles, which means we model the alternative’s possible compliance pathway as utilizing more HD ICE vehicles<sup>1368</sup> than those modeled for the final standards’ potential compliance pathway. In general, this means the alternative has both lower downstream emission reductions, lower

<sup>1368</sup> In this scenario, HD ICE emission rates reflect CO<sub>2</sub> emission improvements projected in previously promulgated standards, notably HD GHG Phase 2.

refinery emissions reductions, and lower upstream EGU emission increases when compared to the final standards. Chapter 4.7 of the RIA contains more discussion on the emission impacts of the alternative.

1. Downstream Emission Comparison

Our estimates of the downstream emission reductions of GHGs that would result from the alternative relative to the reference case are presented in Table

IX-3 for calendar years 2035, 2045, and 2055. Total GHG emissions, or CO<sub>2</sub> equivalent (CO<sub>2</sub>e), are calculated by summing all GHG emissions multiplied by their 100-year Global Warming Potentials (GWP).<sup>1369</sup>

**Table IX-3 Annual Downstream Heavy-Duty GHG Emission Reductions from the Alternative in Calendar Years 2035, 2045, and 2055**

Pollutant	100-year GWP	CY 2035 Reductions		CY 2045 Reductions		CY 2055 Reductions	
		Million Metric Tons	Percent	Million Metric Tons	Percent	Million Metric Tons	Percent
Carbon Dioxide (CO <sub>2</sub> )	1	12.9	3%	21.9	6%	20.7	6%
Methane (CH <sub>4</sub> )	28	0.001	1%	0.001	2%	0.002	3%
Nitrous Oxide (N <sub>2</sub> O)	265	0.002	4%	0.003	7%	0.003	6%
CO <sub>2</sub> Equivalent (CO <sub>2</sub> e)	—	13.4	3%	22.8	6%	21.6	6%

Our estimated GHG emission reductions for the alternative are lower than for the final standards (see section V of this preamble). In 2055, we estimate that the alternative would reduce emissions of CO<sub>2</sub> by 6 percent (the final standards estimate is 20 percent), methane by 3 percent (the final

standards estimate is 12 percent), and N<sub>2</sub>O by 6 percent (the final standards estimate is 20 percent). The resulting total GHG reduction, in CO<sub>2</sub>e, is 6 percent for the alternative versus 20 percent for the final standards.

For both the final standards and the alternative, we modeled potential

compliance pathways based on an increase in the use of zero-emission vehicle technologies. Therefore, we also project that downstream emission reductions of criteria pollutants and air toxics would result from the alternative, relative to the reference case, as presented in Table IX-4.

**Table IX-4 Annual Downstream HD Criteria Pollutant and Air Toxic Emission Reductions from the Alternative in Calendar Years 2035, 2045, and 2055**

Pollutant	2035 Reductions		2045 Reductions		2055 Reductions	
	U.S. Tons	Percent	U.S. Tons	Percent	U.S. Tons	Percent
Oxides of nitrogen (NO <sub>x</sub> )	4,491	1%	17,310	6%	18,107	7%
Particulate matter (PM <sub>2.5</sub> ) <sup>a</sup>	46	1%	74	1%	62	1%
Volatile organic compounds (VOC)	1,118	2%	1,557	4%	1,398	4%
Sulfur dioxide (SO <sub>2</sub> )	49	3%	82	6%	77	6%
Carbon monoxide (CO)	18,388	2%	31,733	5%	29,995	4%
1,3-Butadiene	2	4%	2	3%	0	1%
Acetaldehyde	22	2%	31	4%	29	3%
Benzene	13	3%	10	3%	3	1%
Formaldehyde	14	1%	23	3%	25	3%
Naphthalene <sup>b</sup>	1	2%	1	4%	1	3%

<sup>a</sup> PM<sub>2.5</sub> estimates include both exhaust and non-exhaust emissions. RIA Chapter 4 contains a more detailed discussion of these impacts.

<sup>b</sup> Naphthalene includes both gas and particle phase emissions.

Once again, the emission reductions in criteria pollutants and air toxics that would result from the alternative are smaller than those estimated to result from the final standards. For example, in 2055, we estimate the alternative would reduce NO<sub>x</sub> emissions by 7 percent, PM<sub>2.5</sub> emissions by 1 percent, and VOC emissions by 4 percent. This is compared to the final standards

reductions of NO<sub>x</sub> by 20 percent, PM<sub>2.5</sub> by 5 percent, and VOC by 20 percent for the final standards. Reductions in emissions for air toxics from the alternative range from 1 percent for benzene (the final standards estimate is 25 percent) to 3 percent for formaldehyde (the final standards estimate is 15 percent).

2. Upstream Emission Comparison

Our estimates of the additional GHG emissions from EGUs due to the alternative, relative to the reference case, are presented in Table IX-5 for calendar years 2035, 2045, and 2055, in million metric tons (MMT). Our estimates for additional criteria pollutant emissions are presented in Table IX-6.

<sup>1369</sup> IPCC, 2014: *Climate Change 2014: Synthesis Report. Contribution of Working Groups I, II and III to the Fifth Assessment Report of the*

*Intergovernmental Panel on Climate Change* [Core Writing Team, R.K. Pachauri and L.A. Meyer (eds.)].

Available online: [https://www.ipcc.ch/site/assets/uploads/2018/02/SYR\\_AR5\\_FINAL\\_full.pdf](https://www.ipcc.ch/site/assets/uploads/2018/02/SYR_AR5_FINAL_full.pdf).



**Table IX-5 Annual GHG Emission Increases from EGUs from the Alternative in Calendar Years 2035, 2045, and 2055**

Pollutant	100-year GWP	Additional EGU Emissions (MMT)		
		CY 2035	CY 2045	CY 2055
Carbon Dioxide (CO <sub>2</sub> )	1	12.4	5.4	4.4
Methane (CH <sub>4</sub> )	28	0.00079	0.00013	0.00009
Nitrous Oxide (N <sub>2</sub> O)	265	0.00011	0.00001	0.00001
CO <sub>2</sub> Equivalent (CO <sub>2</sub> e)	---	12.5	5.4	4.4

**Table IX-6 Annual Criteria Pollutant Emission Increases from EGUs from the Alternative in Calendar Years (CYs) 2035, 2045, and 2055**

Pollutant	Additional EGU Emissions (U.S. Tons)		
	CY 2035	CY 2045	CY 2055
Oxides of nitrogen (NO <sub>x</sub> )	4,131	594	520
Primary PM <sub>2.5</sub>	603	223	176
Volatile Organic Compounds (VOC)	198	130	67
Sulfur Dioxide (SO <sub>2</sub> )	4,984	243	24

Because the potential compliance pathway for the alternative assumes lower ZEV adoption rates, we project smaller increases in emissions from EGUs than the final standards. In 2055, we estimate the alternative would increase EGU emissions of CO<sub>2</sub> by 4.4

million metric tons (compared to 12.9 million metric tons from the final standards), with similar trends for all other pollutants. The EGU impacts for all pollutants decrease over time because of projected changes in the power generation mix.

Table IX-7 presents the estimated impact of the alternative on GHG emissions from refineries and Table IX-8 presents the estimated impact of the alternative on criteria pollutant emissions from refineries, both relative to the reference case.

**Table IX-7 Annual GHG Emission Reductions from Refineries Due to the Alternative in Calendar Years 2035, 2045, and 2055**

Pollutant	100-year GWP	Refinery Emission Reductions (Metric Tons)		
		CY 2035	CY 2045	CY 2055
Carbon Dioxide (CO <sub>2</sub> )	1	118,269	163,781	147,787
Methane (CH <sub>4</sub> )	28	6	8	7
Nitrous Oxide (N <sub>2</sub> O)	265	1	1	1
CO <sub>2</sub> Equivalent (CO <sub>2</sub> e)	---	118,707	164,377	148,320

**Table IX-8 Annual Criteria Pollutant Emission Reductions from Refineries Due to the Alternative in Calendar Years (CYs) 2035, 2045, and 2055**

Pollutant	Refinery Emission Reductions (U.S. Tons)		
	CY 2035	CY 2045	CY 2055
Oxides of nitrogen (NO <sub>x</sub> )	52	70	63
Particulate Matter (PM <sub>2.5</sub> )	12	16	14
Volatile Organic Compounds (VOC)	40	54	48
Sulfur Dioxide (SO <sub>2</sub> )	16	22	20

We project smaller reductions in refinery emissions for the alternative than for the final standards (see section V of this preamble), consistent with our projected impacts for downstream emissions. We project a reduction of 147,787 metric tons of CO<sub>2</sub> for the

alternative versus 690,477 metric tons for the final standards.

3. Comparison of Net Emissions Impacts

Table IX-9 shows a summary of our modeled downstream, upstream, and net GHG emission impacts of the alternative relative to the reference case

(i.e., the emissions inventory without the final standards), in million metric tons, for calendar years 2035, 2045, and 2055. Table IX-10 contains a summary of the modeled net impacts of the alternative on criteria pollutant emissions.

**Table IX-9 Annual Net Impacts<sup>a</sup> on GHG Emissions from the Alternative in Calendar Years 2035, 2045, and 2055**

Pollutant	GWP	Calendar Year	Emission Impact (MMT)			
			Downstream	EGU	Refinery	Net
Carbon Dioxide (CO <sub>2</sub> )	1	2035	-12.9	12.4	-0.1	-0.5
		2045	-21.9	5.4	-0.2	-16.6
		2055	-20.7	4.4	-0.1	-16.4
Methane (CH <sub>4</sub> )	28	2035	-0.001	0.001	0.000	0.000
		2045	-0.001	0.000	0.000	-0.001
		2055	-0.002	0.000	0.000	-0.002
Nitrous Oxide (N <sub>2</sub> O)	265	2035	-0.002	0.000	0.000	-0.002
		2045	-0.003	0.000	0.000	-0.003
		2055	-0.003	0.000	0.000	-0.003
CO <sub>2</sub> Equivalent (CO <sub>2</sub> e)	---	2035	-13.4	12.5	-0.1	-1.0
		2045	-22.8	5.4	-0.2	-17.6
		2055	-21.6	4.4	-0.1	-17.3

<sup>a</sup> We present emissions reductions as negative numbers and emission increases as positive numbers.

**Table IX-10 Annual Net Impacts<sup>a</sup> on Criteria Pollutant Emissions from the Alternative in Calendar Years 2035, 2045, and 2055**

Pollutant	Calendar Year	Emission Impact (U.S. Tons)			
		Downstream	EGU	Refinery	Net
Oxides of nitrogen (NO <sub>x</sub> )	2035	-4,491	4,131	-52	-413
	2045	-17,310	594	-70	-16,786
	2055	-18,107	520	-63	-17,650
Particulate Matter (PM <sub>2.5</sub> )	2035	-46	603	-12	545
	2045	-74	223	-16	133
	2055	-62	176	-14	99
Volatile Organic Compounds (VOC)	2035	-1,118	198	-40	-960
	2045	-1,557	130	-54	-1,481
	2055	-1,398	67	-48	-1,379
Sulfur Dioxide (SO <sub>2</sub> )	2035	-49	4,984	-16	4,918
	2045	-82	243	-22	139
	2055	-77	24	-20	-73

<sup>a</sup> We present emissions reductions as negative numbers and emission increases as positive numbers.

In 2055, we estimate the alternative would result in a net decrease of 17 million metric tons of GHG emissions, compared to 61 million metric tons for the final standards. Like the final standards, we project net decreases in emissions of NO<sub>x</sub>, VOC, and SO<sub>2</sub> in 2055 but a net increase in PM<sub>2.5</sub> emissions. Consistent with other

emissions impacts trends discussed for the alternative, the magnitude of these net impacts is smaller for the alternative than for the final standards.

**4. Comparison of Cumulative GHG Impacts**

The warming impacts of GHGs are cumulative. Table V-13, Table V-14,

and Table V-15 present the cumulative GHG impacts that we model would result from both the final standards and the alternative from 2027 through 2055 for downstream emissions, EGU emissions, and refinery emissions, respectively, relative to the reference case.

**Table IX-11 Cumulative 2027-2055 Downstream Heavy-Duty GHG Emission Reductions from the Final Standards and the Alternative**

Pollutant	Final Standards		Alternative	
	Reduction in MMT	Percent	Reduction in MMT	Percent
Carbon Dioxide (CO <sub>2</sub> )	1,347	13%	454	4%
Methane (CH <sub>4</sub> )	0.127	7%	0.030	2%
Nitrous Oxide (N <sub>2</sub> O)	0.199	13%	0.071	5%
CO <sub>2</sub> Equivalent (CO <sub>2</sub> e)	1,404	13%	473	4%

**Table IX-12 Cumulative 2027-2055 GHG Emission Increases from EGUs from the Final Standards and the Alternative**

Pollutant	Increase in MMT	
	Final Standards	Alternative
Carbon Dioxide (CO <sub>2</sub> )	391.4	155.3
Methane (CH <sub>4</sub> )	0.018	0.008
Nitrous Oxide (N <sub>2</sub> O)	0.002	0.001
CO <sub>2</sub> Equivalent (CO <sub>2</sub> e)	392.5	155.7

**Table IX-13 Cumulative 2027-2055 GHG Emission Reductions from Refineries from the Final Standards and the Alternative**

Pollutant	Reduction in MMT	
	Final Standards	Alternative
Carbon Dioxide (CO <sub>2</sub> )	13.4	3.6
Methane (CH <sub>4</sub> )	0.0007	0.0000
Nitrous Oxide (N <sub>2</sub> O)	0.0001	0.0000
CO <sub>2</sub> Equivalent (CO <sub>2</sub> e)	13.5	3.6

Overall, we estimate the alternative would reduce net GHG emissions by 321 million metric tons between 2027 and 2055, relative to the reference case, as is presented in Table V-16. This is less than one third the total reduction from the final standards, which is more than 1 billion metric tons.

**Table IX-14 Cumulative 2027-2055 Net GHG Emission Impacts<sup>a</sup> (in MMT) Reflecting the Alternative**

Pollutant	Downstream	EGU	Refineries	Net
Carbon Dioxide (CO <sub>2</sub> )	-454	155	-4	-302
Methane (CH <sub>4</sub> )	-0.030	0.008	0.000	-0.023
Nitrous Oxide (N <sub>2</sub> O)	-0.071	0.001	0.000	-0.070
CO <sub>2</sub> Equivalent (CO <sub>2</sub> e)	-473	156	-4	-321

<sup>a</sup> We present emissions reductions as negative numbers and emission increases as positive numbers.

*C. Program Costs Comparison of the Final Rule and Alternative*

Using the cost elements outlined in sections IV.B, IV.C, and IV.D, we have estimated the costs associated with the final rule and alternative relative to the reference case, as shown in Table IX-15.

Costs are presented in more detail in Chapter 3 of the RIA. As noted earlier, costs are presented in 2022\$ in undiscounted annual values along with net present values and annualized values at 2, 3, and 7 percent discount rates with values discounted to the 2027 calendar year.

As shown in Table IX-15, our analysis demonstrates that the final standards will have the lowest cost compared to the alternative and reference cases for all net present and annualized values at all three discount rates.

**Table IX-15 Total Technology, Operating Cost and EVSE Cost Impacts of the Final Standards Relative to the Reference Case and the Alternative Option Relative to the Reference Case, All Regulatory Classes and All Fuels, Millions of 2022\$<sup>a</sup>**

Calendar Year	Final Rule				Alternative			
	Total Technology Costs	Total Operating Costs	Total EVSE RPE Costs	Total Program Cost	Total Technology Costs	Total Operating Costs	Total EVSE RPE Costs	Total Program Cost
2027	\$30	-\$100	\$440	\$370	\$1.8	-\$59	\$250	\$200
2028	-\$14	-\$220	\$610	\$380	-\$32	-\$120	\$290	\$130
2029	-\$85	-\$390	\$730	\$260	-\$69	-\$220	\$410	\$120
2030	\$160	-\$380	\$630	\$410	\$110	-\$210	\$360	\$250
2031	\$270	-\$540	\$1,300	\$1,100	\$210	-\$240	\$480	\$450
2032	\$480	-\$810	\$2,000	\$1,700	\$280	-\$310	\$620	\$590
2033	\$310	-\$1,200	\$1,900	\$1,000	\$250	-\$380	\$490	\$360
2034	\$260	-\$1,600	\$1,700	\$360	\$270	-\$470	\$380	\$170
2035	\$160	-\$2,200	\$1,600	-\$450	\$280	-\$600	\$260	-\$66
2036	\$23	-\$2,500	\$1,600	-\$950	\$240	-\$630	\$240	-\$140
2037	-\$25	-\$3,000	\$1,500	-\$1,400	\$230	-\$670	\$220	-\$220
2038	-\$140	-\$3,300	\$1,500	-\$2,000	\$210	-\$710	\$200	-\$290
2039	-\$230	-\$3,700	\$1,500	-\$2,400	\$190	-\$730	\$180	-\$350
2040	-\$260	-\$4,100	\$1,500	-\$2,900	\$190	-\$760	\$160	-\$410
2041	-\$330	-\$4,300	\$1,500	-\$3,100	\$180	-\$640	\$140	-\$310
2042	-\$400	-\$4,600	\$1,400	-\$3,500	\$160	-\$670	\$130	-\$380
2043	-\$390	-\$5,100	\$1,400	-\$4,000	\$160	-\$670	\$130	-\$380
2044	-\$450	-\$5,400	\$1,400	-\$4,400	\$140	-\$670	\$120	-\$410
2045	-\$510	-\$5,100	\$1,400	-\$4,200	\$120	-\$560	\$120	-\$320
2046	-\$490	-\$4,900	\$1,300	-\$4,100	\$110	-\$520	\$110	-\$290
2047	-\$530	-\$5,400	\$1,300	-\$4,600	\$100	-\$660	\$110	-\$460
2048	-\$560	-\$5,800	\$1,300	-\$5,100	\$87	-\$800	\$100	-\$610
2049	-\$590	-\$6,300	\$1,300	-\$5,600	\$75	-\$950	\$99	-\$780
2050	-\$570	-\$6,600	\$1,200	-\$5,900	\$76	-\$1,000	\$95	-\$840
2051	-\$590	-\$6,800	\$1,200	-\$6,100	\$67	-\$1,000	\$92	-\$880
2052	-\$620	-\$7,000	\$1,200	-\$6,400	\$58	-\$1,100	\$89	-\$920
2053	-\$640	-\$7,100	\$1,200	-\$6,600	\$50	-\$1,100	\$86	-\$960
2054	-\$610	-\$7,300	\$1,200	-\$6,700	\$54	-\$1,100	\$82	-\$980
2055	-\$590	-\$7,400	\$1,100	-\$6,900	\$55	-\$1,100	\$79	-\$1,000
PV, 2%	-\$4,200	-\$76,000	\$28,000	-\$52,000	\$3,000	-\$13,000	\$5,000	-\$5,100
PV, 3%	-\$3,200	-\$63,000	\$25,000	-\$42,000	\$2,600	-\$11,000	\$4,600	-\$3,800
PV, 7%	-\$1,000	-\$32,000	\$15,000	-\$18,000	\$1,700	-\$6,100	\$3,400	-\$1,000
AV, 2%	-\$190	-\$3,500	\$1,300	-\$2,400	\$140	-\$600	\$230	-\$230
AV, 3%	-\$170	-\$3,300	\$1,300	-\$2,200	\$140	-\$580	\$240	-\$200
AV, 7%	-\$83	-\$2,600	\$1,300	-\$1,400	\$140	-\$490	\$270	-\$83

<sup>a</sup> Values show 2 significant digits; negative cost values denote savings; calendar year values are undiscounted, present values are discounted to 2027. Total Program Cost is the sum of Total Technology Cost, Total Operating Cost, and Total EVSE RPE costs.

**D. Benefits**

**1. Climate Benefits**

Our estimates of the climate benefits from the GHG emissions reductions associated with the alternative are similar to those discussed for the final rule in section VII of this preamble.

Table IX-16 presents the annual, undiscounted monetized climate benefits of reduced GHG emissions using social cost of GHG (SC-GHG) values presented in the EPA Report on the Social Cost of Greenhouse Gases: Estimates Incorporating Recent

Scientific Advances<sup>1370</sup> for the years beginning with the first year of rule implementation, 2027, through 2055 for the alternative and final standards. Also shown are the present values and equivalent annualized values associated with each of the SC-GHG values. For

<sup>1370</sup> EPA Report on the Social Cost of Greenhouse Gases: Estimates Incorporating Recent Scientific Advances.

more detailed information about the climate benefits analysis conducted for the final standards and alternative,

please refer to section 7.1 of the RIA. See sections V and IX.B of this preamble for our analysis of GHG emission

impacts of the final standards and alternative, respectively.

**Table IX-16 Climate Benefits from Reduction in GHG Emissions Associated with the Final and Alternative Standards, Millions of 2022\$**

	Final Standards			Alternative		
	Near-term Ramsey Discount Rate			Near-term Ramsey Discount Rate		
	2.5%	2%	1.5%	2.5%	2%	1.5%
2027	\$46	\$73	\$120	\$27	\$43	\$73
2028	\$100	\$160	\$270	\$56	\$89	\$150
2029	\$160	\$260	\$430	\$90	\$140	\$240
2030	\$210	\$330	\$550	\$120	\$190	\$310
2031	\$330	\$510	\$850	\$150	\$240	\$390
2032	\$500	\$770	\$1,300	\$190	\$300	\$480
2033	\$650	\$1,000	\$1,600	\$210	\$330	\$530
2034	\$780	\$1,200	\$2,000	\$220	\$330	\$530
2035	\$880	\$1,400	\$2,200	\$200	\$300	\$480
2036	\$2,000	\$3,100	\$4,900	\$600	\$920	\$1,500
2037	\$3,400	\$5,300	\$8,500	\$1,100	\$1,700	\$2,800
2038	\$5,100	\$7,900	\$13,000	\$1,700	\$2,700	\$4,400
2039	\$7,100	\$11,000	\$18,000	\$2,500	\$3,800	\$6,200
2040	\$9,400	\$15,000	\$23,000	\$3,300	\$5,100	\$8,200
2041	\$10,000	\$15,000	\$25,000	\$3,400	\$5,300	\$8,500
2042	\$11,000	\$16,000	\$26,000	\$3,600	\$5,400	\$8,700
2043	\$11,000	\$17,000	\$27,000	\$3,600	\$5,600	\$8,900
2044	\$11,000	\$17,000	\$28,000	\$3,700	\$5,600	\$9,000
2045	\$12,000	\$18,000	\$28,000	\$3,800	\$5,700	\$9,000
2046	\$12,000	\$19,000	\$29,000	\$3,900	\$5,800	\$9,200
2047	\$13,000	\$19,000	\$30,000	\$3,900	\$6,000	\$9,400
2048	\$13,000	\$20,000	\$31,000	\$4,000	\$6,100	\$9,500
2049	\$14,000	\$20,000	\$32,000	\$4,100	\$6,200	\$9,600
2050	\$14,000	\$21,000	\$32,000	\$4,200	\$6,300	\$9,800
2051	\$14,000	\$21,000	\$33,000	\$4,200	\$6,300	\$9,800
2052	\$14,000	\$21,000	\$33,000	\$4,300	\$6,300	\$9,800
2053	\$15,000	\$22,000	\$34,000	\$4,300	\$6,400	\$9,800
2054	\$15,000	\$22,000	\$34,000	\$4,300	\$6,400	\$9,800
2055	\$15,000	\$22,000	\$34,000	\$4,300	\$6,400	\$9,800
PV	\$130,000	\$220,000	\$390,000	\$42,000	\$71,000	\$120,000
AV	\$6,600	\$10,000	\$17,000	\$2,100	\$3,200	\$5,300

2. Criteria Pollutant Reductions

Table IX-17 presents the total annual, undiscounted PM<sub>2.5</sub>-related health benefits estimated for the stream of years beginning with the first year of rule implementation, 2027, through calendar year 2055 for the final CO<sub>2</sub> emission standards and alternative. The range of benefits in Table IX-17 reflects the range of premature mortality estimates based on risk estimates reported from two different long-term exposure studies using different cohorts to account for uncertainty in the benefits associated with avoiding PM-

related premature deaths.<sup>1371 1372</sup> Although annual benefits presented in the table are not discounted for the purposes of present value or annualized value calculations, annual benefits do reflect the use of 3 percent and 7 percent discount rates to account for avoided health outcomes that are expected to accrue over more than a

<sup>1371</sup> Wu, X, Braun, D, Schwartz, J, Kioumourtzoglou, M and Dominici, F (2020). Evaluating the impact of long-term exposure to fine particulate matter on mortality among the elderly. Science advances 6(29): eaba5692.

<sup>1372</sup> Pope III, CA, Lefler, JS, Ezzati, M, Higbee, JD, Marshall, JD, Kim, S-Y, Bechle, M, Gilliat, KS, Vernon, SE and Robinson, AL (2019). Mortality risk and fine particulate air pollution in a large, representative cohort of US adults. Environmental health perspectives 127(7): 077007.

single year (the “cessation lag” between the change in PM exposures and the total realization of changes in health effects). The table also displays the present and annualized value of estimated benefits that occur from 2027 to 2055, discounted using both 3 percent and 7 percent discount rates and reported in 2022\$.

The PM<sub>2.5</sub>-related health benefits of a less stringent alternative program are – \$3.0 to \$2.1 million assuming a 3 percent discount rate and – \$77 to – \$36 million assuming a 7 percent discount rate (2022\$). We use a constant 3 percent and 7-percent discount rate to calculate present and annualized values in Table IX-17, consistent with current

applicable OMB Circular No. A-4 guidance (2003). For the purposes of presenting total net benefits (see preamble section VIII), we also use a constant 2 percent discount rate to calculate present and annualized values. We note that we do not currently have BPT estimates that use a 2-percent

discount rate to account for cessation lag. If we apply a constant 2 percent discount rate to the stream of annual benefits based on the 3 percent cessation lag BPT, annualized benefits would be \$15 to \$22 million. Depending on the discount rate used, the present and annualized value of the stream of

PM<sub>2.5</sub> health benefits may either be positive or negative.

For more detailed information about the benefits analysis conducted for the final standards and alternative, please refer to Chapter 7 of the RIA.

**BILLING CODE 6560-50-P**

**Table IX-17 Year-Over-Year Monetized PM<sub>2.5</sub>-Related Health Benefits<sup>a</sup> Associated With the Final Standards and Alternative, Millions of 2022\$**

	Final		Alternative	
	3% Discount Rate	7% Discount Rate	3% Discount Rate	7% Discount Rate
2027	\$(4.3)-(9.0)	\$(3.9)-(8.1)	\$(1.8)-(3.7)	\$(1.6)-(3.3)
2028	\$(14)-(29)	\$(12)-(26)	\$(4.6)-(9.7)	\$(4.2)-(8.7)
2029	\$(29)-(61)	\$(26)-(54)	\$(13)-(27)	\$(12)-(24)
2030	\$(74)-(150)	\$(67)-(140)	\$(43)-(88)	\$(38)-(79)
2031	\$(180)-(360)	\$(160)-(320)	\$(96)-(200)	\$(86)-(180)
2032	\$(370)-(760)	\$(340)-(690)	\$(180)-(370)	\$(160)-(330)
2033	\$(580)-(1,200)	\$(520)-(1,100)	\$(260)-(540)	\$(240)-(490)
2034	\$(790)-(1,600)	\$(710)-(1,400)	\$(350)-(710)	\$(320)-(640)
2035	\$(1,000)-(2,000)	\$(900)-(1,800)	\$(440)-(880)	\$(390)-(790)
2036	\$(930)-(1,900)	\$(840)-(1,700)	\$(400)-(800)	\$(360)-(720)
2037	\$(750)-(1,500)	\$(680)-(1,400)	\$(320)-(650)	\$(290)-(580)
2038	\$(470)-(940)	\$(420)-(840)	\$(210)-(410)	\$(190)-(370)
2039	\$(96)-(190)	\$(87)-(170)	\$(61)-(120)	\$(55)-(110)
2040	\$360-710	\$320-640	\$110-230	\$100-200
2041	\$440-860	\$390-770	\$140-270	\$120-240
2042	\$510-1,000	\$460-910	\$160-320	\$140-290
2043	\$590-1,200	\$530-1,000	\$180-360	\$160-320
2044	\$660-1,300	\$590-1,200	\$200-400	\$180-360
2045	\$730-1,400	\$650-1,300	\$220-430	\$200-390
2046	\$770-1,500	\$690-1,400	\$230-450	\$210-410
2047	\$810-1,600	\$730-1,400	\$240-470	\$220-420
2048	\$850-1,700	\$770-1,500	\$250-480	\$220-440
2049	\$890-1,700	\$800-1,600	\$260-500	\$230-450
2050	\$920-1,800	\$830-1,600	\$260-510	\$240-460
2051	\$940-1,800	\$850-1,600	\$270-520	\$240-460
2052	\$960-1,900	\$860-1,700	\$270-520	\$240-470
2053	\$970-1,900	\$880-1,700	\$270-520	\$240-470
2054	\$990-1,900	\$890-1,700	\$270-520	\$240-470
2055	\$1,000-1,900	\$900-1,700	\$270-520	\$240-470
PV	\$2,300-4,200	\$(110)-(400)	\$40-(58)	\$(440)-(950)
AV	\$120-220	\$(9.1)-(32)	\$2.1-(3.0)	\$(36)-(77)

<sup>a</sup> The benefits in this table reflect two premature mortality estimates derived from the Medicare study (Wu et al., 2020) and the NHIS study (Pope et al., 2019), respectively. All benefits estimates are rounded to two significant figures. Annual benefit values presented here are not discounted. Negative values in parentheses are health disbenefits related to increases in estimated emissions. The present value of benefits is the total aggregated value of the series of discounted annual benefits that occur between 2027-2055 (in 2022\$) using either a 3 percent or 7 percent discount rate. Depending on the discount rate used, the present and annualized value of the stream of PM<sub>2.5</sub> health benefits may either be positive or negative. The upstream impacts associated with the standards presented here include health benefits associated with reduced criteria pollutant emissions from refineries and health disbenefits associated with increased criteria pollutant emissions from EGUs. The benefits in this table also do not include the full complement of health and environmental benefits (such as health benefits related to reduced ozone exposure that, if quantified and monetized, would increase the total monetized benefits.

3. Energy Security

In Table IX-18, EPA presents the macroeconomic oil security premiums

and the energy security benefits for the final standards and alternative for the years 2027 through 2055. The oil security premiums and the energy

security benefits for the final CO<sub>2</sub> emission standards are further discussed in section VII.

**Table IX-18 Oil Security Premiums (2022\$/barrel) and the Energy Security Benefits (Millions of 2022\$) from 2027–2055 for the Alternative<sup>a</sup>**

Calendar Year	Oil Security Premium (range)	Benefits	
		Final	Alternative
2027	\$3.73 (\$0.51 - \$7.02)	\$4	\$2
2028	\$3.78 (\$0.51 - \$7.15)	\$10	\$5
2029	\$3.87 (\$0.54 - \$7.31)	\$18	\$9
2030	\$3.92 (\$0.51 - \$7.46)	\$32	\$18
2031	\$4.00 (\$0.55 - \$7.62)	\$65	\$34
2032	\$4.05 (\$0.53 - \$7.77)	\$120	\$57
2033	\$4.11 (\$0.47 - \$7.93)	\$180	\$79
2034	\$4.16 (\$0.44 - \$8.07)	\$240	\$100
2035	\$4.22 (\$0.45 - \$8.20)	\$300	\$120
2036	\$4.28 (\$0.44 - \$8.29)	\$360	\$140
2037	\$4.35 (\$0.47 - \$8.40)	\$410	\$160
2038	\$4.44 (\$0.52 - \$8.55)	\$460	\$170
2039	\$4.50 (\$0.53 - \$8.66)	\$510	\$190
2040	\$4.62 (\$0.65 - \$8.85)	\$560	\$200
2041	\$4.73 (\$0.70 - \$9.04)	\$600	\$210
2042	\$4.77 (\$0.69 - \$9.15)	\$640	\$220
2043	\$4.82 (\$0.67 - \$9.27)	\$670	\$230
2044	\$4.85 (\$0.66 - \$9.35)	\$690	\$230
2045	\$4.91 (\$0.68 - \$9.43)	\$720	\$240
2046	\$4.98 (\$0.71 - \$9.52)	\$740	\$240
2047	\$5.09 (\$0.82 - \$9.68)	\$760	\$250
2048	\$5.14 (\$0.85 - \$9.79)	\$770	\$250
2049	\$5.16 (\$0.82 - \$9.85)	\$780	\$250
2050	\$5.22 (\$0.91 - \$9.89)	\$790	\$250
2051	\$5.22 (\$0.91 - \$9.89)	\$800	\$250
2052	\$5.22 (\$0.91 - \$9.89)	\$800	\$250
2053	\$5.22 (\$0.91 - \$9.89)	\$800	\$240
2054	\$5.22 (\$0.91 - \$9.89)	\$800	\$240
2055	\$5.22 (\$0.91 - \$9.89)	\$800	\$240
PV, 2%		\$9,800	\$3,400
PV, 3%		\$8,200	\$2,800
PV, 7%		\$4,200	\$1,500
AV, 2%		\$450	\$150
AV, 3%		\$430	\$150
AV, 7%		\$340	\$120

ORNL's oil security premium methodology provides estimates through 2050. For years 2051–2055 we use the value of the 2050 oil security premium.

**BILLING CODE 6560-50-C**

*E. How do the final standards and alternative compare in overall benefits and costs?*

Table IX-19 shows the estimated net benefits for the final standards and alternative relative to the reference case, at 2, 3 and 7 percent discount rates, respectively. Preamble section VIII and Chapter 8 of the RIA presents more

detailed results. These estimated net benefits are the sum of benefits and operating savings minus vehicle costs.

As noted in preamble section VIII's discussion of costs and benefits for the final standards, EPA's consistent practice has been to set standards to achieve improved air quality consistent with CAA section 202 and not to rely on cost-benefit calculations, with their uncertainties and limitations, in

identifying the appropriate standards. Nonetheless, the significantly greater benefits for the final standards relative to the alternative provide reinforcing support for EPA's decision to adopt the final standards in lieu of the alternative. For example, in 2055, the final rule would result in net benefits of \$32 billion dollars (2022\$), which is significantly greater than the alternative's net benefits of \$8.3 billion.



**Table IX-19 Net Benefits Associated with the Final and Alternative Standards, Millions of 2022\$**

	Net Benefits	
	Final Rule	Alternative
2055	\$32,000	\$8,100
PV, 2%	\$290,000	\$80,000
PV, 3%	\$280,000	\$77,000
PV, 7%	\$250,000	\$72,000
AV, 2%	\$13,000	\$3,600
AV, 3%	\$13,000	\$3,600
AV, 7%	\$12,000	\$3,400

**Notes:**

Net benefits are the sum of climate benefits, non-GHG pollutant benefits, energy security benefits, and operating savings, minus vehicle costs.

Climate benefits are based on reductions in GHG emissions and are calculated using three different SC-GHG estimates that assume either a 1.5 percent, 2.0 percent, or 2.5 percent near-term Ramsey discount rate (see Table VIII-5). For presentational purposes in this table, we use the climate benefits associated with the SC-GHG estimates under the 2 percent near-term Ramsey discount rate for the total benefits calculation.

For presentational clarity, we use the monetized suite of total avoided PM<sub>2.5</sub>-related health effects that includes avoided deaths based on the Pope III et al., 2019 study, which is the larger of the two PM<sub>2.5</sub> health benefits estimates presented in section IX.D.2. All benefits estimates are rounded to two significant figures.

**X. Statutory and Executive Order Reviews**

Additional information about these statutes and Executive orders can be found at <https://www.epa.gov/laws-regulations/laws-and-executive-orders>.

**A. Executive Order 12866: Regulatory Planning and Review and Executive Order 14094: Modernizing Regulatory Review**

This action is a “significant regulatory action,” as defined under section 3(f)(1) of Executive Order 12866, as amended by Executive Order 14094. Accordingly, EPA submitted this action to the Office of Management and Budget (OMB) for Executive Order 12866 review. Documentation of any changes made in response to the Executive Order 12866 review is available in the docket. The EPA prepared an analysis of the potential costs and benefits associated with this action. This analysis, the “Regulatory Impact Analysis—Greenhouse Gas Emissions Standards for Heavy-Duty Vehicles: Phase 3—Final Rulemaking,” is available in the docket.<sup>1373</sup> The analyses contained in the RIA document are also summarized in sections II, IV, V, VI, VII, VIII, and IX of this preamble.

**B. Paperwork Reduction Act (PRA)**

The information collection activities in this rule have been submitted for approval to the Office of Management and Budget (OMB) under the PRA. The Information Collection Request (ICR)

that EPA prepared has been assigned EPA ICR Number 2734.02. You can find a copy of the Supporting Statement in the docket for this rule, and it is briefly summarized here. The information collection requirements are not enforceable until OMB approves them.

This rulemaking consists of targeted updates and new GHG emission standards for heavy-duty vehicles beginning with MY 2027. While there will be changes to the EV–CIS data system to reflect new standards, this will not affect manufacturer reporting. In addition, While EPA has committed to post-rule monitoring of the implementation of the heavy-duty vehicle GHG programs, that monitoring is expected to rely on manufacturer-submitted certification data and will not impose additional reporting requirements. As part of this monitoring program, EPA will continue to evaluate the data collection needs and will create a new ICR if we determine additional data is needed. Finally, the information collection activities for EPA’s Phase 2 GHG program do not change as a result of this rule. While manufacturers are expected to experience a cost associated with reviewing the new requirements, they already submit the data that would be required for certification to the standards to EPA’s certification system (under programmatic ICRs). There would be a change only to the specific data reported, not its reporting.

- *Respondents/affected entities:* Manufacturers of heavy-duty onroad vehicles.
- *Respondent’s obligation to respond:* Regulated entities must respond to this collection if they wish to sell their

products in the United States, as prescribed by CAA section 203(a). Participation in some programs is voluntary; but once a manufacturer has elected to participate, it must submit the required information.

- *Estimated number of respondents:* Approximately 77 heavy-duty vehicle manufacturers.
- *Frequency of response:* One-time burden associated with reviewing the new requirements for all manufacturers; for EV manufacturers, one-time burden associated with new battery health monitor provisions, warranty reporting requirements, and associated revisions to owners’ manuals.
- *Total estimated burden:* 7,411 hours. Burden is defined at 5 CFR 1320.03(b).
- *Total estimated cost:* \$1.622 million; includes an estimated \$936,500 in maintenance and operational costs.

An agency may not conduct or sponsor, and a person is not required to respond to, a collection of information unless it displays a currently valid OMB control number. The OMB control numbers for EPA’s regulations in Title 40 of the Code of Federal Regulations are listed in 40 CFR part 9. When OMB approves this ICR, the Agency will announce that approval in the **Federal Register** and publish a technical amendment to 40 CFR part 9 to display the OMB control number for the approved information collection activities contained in this final rule.

**C. Regulatory Flexibility Act (RFA)**

I certify that this action will not have a significant economic impact on a substantial number of small entities under the RFA. As explained in this

<sup>1373</sup> U.S. EPA. Regulatory Impact Analysis—Greenhouse Gas Emissions Standards for Heavy-Duty Vehicles: Phase 3. EPA-420-R-24-006. March 2024.

preamble, EPA is exempting small entities from the revisions to EPA's Phase 2 GHG standards for MY 2027 and the new GHG standards for MYs 2028 through 2032 and later. Small EV manufacturers are subject to new battery health monitor provisions and warranty provisions, which include making associated revisions to owners' manuals. There are 10 small companies that are affected by the requirements. The estimated burden is not expected to exceed 3 percent of annual revenue for any small entity, and is expected to be between 1 and 3 percent of annual revenue for only one company. We therefore conclude that this action will not have a significant economic impact on a substantial number of small entities within the regulated industries. More information concerning the small entities and our conclusion is presented in Chapter 9 of the RIA.

*D. Unfunded Mandates Reform Act (UMRA)*

This action contains no unfunded Federal mandate for State, local, or Tribal governments as described in UMRA, 2 U.S.C. 1531–1538, and does not significantly or uniquely affect small governments. This action imposes no enforceable duty on any State, local, or Tribal government. This action contains Federal mandates under UMRA that may result in annual expenditures of \$100 million or more for the private sector. Accordingly, the costs and benefits associated with this action are discussed in sections IV, VII, and VIII of this preamble and in the RIA, which is in the docket for this rule.

This action is not subject to the requirements of UMRA section 203 because it contains no regulatory requirements that might significantly or uniquely affect small governments.

*E. Executive Order 13132: Federalism*

The action we are finalizing for HD Phase 3 CO<sub>2</sub> emission standards and related regulations does not have federalism implications. The final HD Phase 3 CO<sub>2</sub> emission standards and related regulations will not have substantial direct effects on the states, on the relationship between the National Government and the states, or on the distribution of power and responsibilities among the various levels of government.

*F. Executive Order 13175: Consultation and Coordination With Indian Tribal Governments*

This action does not have Tribal implications as specified in Executive Order 13175. Thus, Executive Order 13175 does not apply to this action.

This action does not have substantial direct effects on one or more Indian tribes, on the relationship between the Federal Government and Indian tribes, or on the distribution of power and responsibilities between the Federal Government and Indian tribes. However, EPA has engaged with Tribal stakeholders in the development of this rulemaking by holding a Tribal workshop, offering information sessions to Tribal organizations, and offering government-to-government consultation upon request.

*G. Executive Order 13045: Protection of Children From Environmental Health and Safety Risks*

This action is subject to Executive Order 13045 because it is a significant regulatory action under section 3(f)(1) of Executive Order 12866, and EPA believes that the environmental health risks or safety risks of the pollutants addressed by this action may have a disproportionate effect on children. The 2021 Policy on Children's Health also applies to this action.<sup>1374</sup> Accordingly, we have evaluated the environmental health or safety effects of air pollutants affected by the final rule on children. The results of this evaluation are described in section VI of the preamble and Chapter 5 of the RIA. The protection offered by these standards may be especially important for children because childhood represents a life stage associated with increased susceptibility to air pollutant-related health effects.

GHG emissions contribute to climate change and the GHG emissions reductions described in section V of this preamble resulting from this rule will contribute to mitigation of climate change. The assessment literature cited in EPA's 2009 and 2016 Endangerment Findings concluded that certain populations and life stages, including children, the elderly, and the poor, are most vulnerable to climate-related health effects. The assessment literature since 2016 strengthens these conclusions by providing more detailed findings regarding these groups' vulnerabilities and the projected impacts they may experience. These assessments describe how children's unique physiological and developmental factors contribute to making them particularly vulnerable to climate change. Impacts to children are expected from heat waves, air pollution, infectious and waterborne illnesses, and

mental health effects resulting from extreme weather events. In addition, children are among those especially susceptible to most allergic diseases, as well as health effects associated with heat waves, storms, and floods. Additional health concerns may arise in low-income households, especially those with children, if climate change reduces food availability and increases prices, leading to food insecurity within households. More detailed information on the impacts of climate change to human health and welfare is provided in section VI.A of this preamble.

Children make up a substantial fraction of the U.S. population, and often have unique factors that contribute to their increased risk of experiencing a health effect from exposures to ambient air pollutants because of their continuous growth and development. Children are more susceptible than adults to many air pollutants because they have (1) a developing respiratory system, (2) increased ventilation rates relative to body mass compared with adults, (3) an increased proportion of oral breathing, particularly in boys, relative to adults, and (4) behaviors that increase chances for exposure. Even before birth, the developing fetus may be exposed to air pollutants through the mother that affect development and permanently harm the individual when the mother is exposed.

In addition to reducing GHGs, this final rule will also reduce onroad emissions of criteria pollutants and air toxics. Section V of this preamble presents the estimated onroad emissions reductions from the rule. Certain motor vehicle emissions present greater risks to children. Early lifestages (e.g., children) are thought to be more susceptible to tumor development than adults when exposed to carcinogenic chemicals that act through a mutagenic mode of action.<sup>1375</sup> Exposure at a young age to these carcinogens could lead to a higher risk of developing cancer later in life. Chapter 5.2.8 of the RIA describes a systematic review and meta-analysis conducted by the U.S. Centers for Disease Control and Prevention that reported a positive association between proximity to traffic and the risk of leukemia in children. Also, section VI.B of this preamble and Chapter 5 of the RIA discuss a number of childhood health outcomes associated with proximity to roadways, including

<sup>1374</sup> U.S. Environmental Protection Agency (2021). 2021 Policy on Children's Health. Washington, DC. <https://www.epa.gov/system/files/documents/2021-10/2021-policy-on-childrens-health.pdf>.

<sup>1375</sup> U.S. Environmental Protection Agency (2005). Supplemental guidance for assessing susceptibility from early-life exposure to carcinogens. Washington, DC: Risk Assessment Forum. EPA/630/R-03/003F. [https://www3.epa.gov/airtoxics/childrens\\_supplement\\_final.pdf](https://www3.epa.gov/airtoxics/childrens_supplement_final.pdf).

evidence for exacerbation of asthma symptoms and suggestive evidence for new onset asthma.

In addition to reduced onroad emissions of criteria pollutants and air toxics, we expect the rule will also lead to reductions in refinery emissions and increases in pollutant emissions from EGUs (see preamble section V). As described in section VI.B of this preamble and Chapter 5 of the RIA, the Integrated Science Assessments for a number of pollutants affected by this rule, including those for SO<sub>2</sub>, NO<sub>2</sub>, PM, ozone, and CO, describe children as a group with greater susceptibility.

There is substantial evidence that people who live or attend school near major roadways are more likely to be people of color, Hispanic ethnicity, and/or low socioeconomic status. Analyses of communities in close proximity to sources such as EGUs and refineries have also found that a higher percentage of communities of color and low-income communities live near these sources when compared to national averages. Within these highly exposed groups, children's exposure and susceptibility to health effects is greater than adults due to school-related and seasonal activities, behavior, and physiological factors.

Children are not expected to experience greater ambient concentrations of air pollutants compared to the general population. However, because of their greater susceptibility to air pollution, including the impacts of a changing climate, and their increased time spent outdoors, it is likely that the GHG emissions reductions associated with the standards will have particular benefits for children's health.

*H. Executive Order 13211: Actions Concerning Regulations That Significantly Affect Energy Supply, Distribution, or Use*

This action is not a "significant energy action" because it is not likely to have a significant adverse effect on the supply, distribution, or use of energy. EPA has outlined the energy effects in section VI of this preamble and Chapter 5 of the RIA, which is available in the docket for this action and is briefly summarized here.

This action will reduce CO<sub>2</sub> emissions from heavy-duty vehicles under revised GHG standards, which will result in significant reductions in the consumption of petroleum, increase electricity consumption, achieve energy security benefits (described in section VII.C of this preamble), and have no

adverse energy effects. As shown in Table 6-1 in the RIA, EPA projects that through 2055 these standards will result in a reduction of 135 billion gallons of diesel and gasoline consumption and an increase of 2,300 TWh of electricity consumption (RIA 6.5). As discussed in preamble section II.D.2.iii.d, we do not expect the increased electricity consumption under this rule to have significant adverse impacts on the electric grid.

*I. National Technology Transfer and Advancement Act (NTTAA) and 1 CFR part 51*

This action involves technical standards. Except for the standards discussed in this section, the standards included in the regulatory text as incorporated by reference were all previously approved for IBR and no change is included in this action.

In accordance with the requirements of 1 CFR 51.5, we are incorporating by reference the use of test methods and standards from ASTM International (ASTM). The referenced standards and test methods may be obtained through the ASTM website ([www.astm.org](http://www.astm.org)) or by calling (610) 832-9585. We are incorporating by reference the following ASTM standards:

Standard or Test Method	Regulation	Summary
ASTM D6348-12 <sup>1</sup> , Standard Test Method for Determination of Gaseous Compounds by Extractive Direct Interface Fourier Transform Infrared (FTIR) Spectroscopy.	40 CFR 1065.257(b), 1065.277(b)(2), and 1065.1010(a)(40).	Analytical procedures for interpretation of infrared spectra used in new test procedures for measuring H <sub>2</sub> O and NH <sub>3</sub> . This final rule cites the reference document in additional places in the regulation.

In accordance with the requirements of 1 CFR 51.5, we are incorporating by reference the use of test methods and standards from National Institute of

Standards and Technology (NIST). The referenced standards and test methods may be obtained through the NIST website ([www.nist.gov](http://www.nist.gov)) or by calling

(301) 975-6478. We are incorporating by reference the following NIST standards:

Standard or Test Method	Regulation	Summary
NIST Technical Note 1297, Guidelines for Evaluating and Expressing the Uncertainty of NIST Measurement Results.	40 CFR 1065.365(g) introductory text, 1065.750(a)(6), and 1065.1010(e)(2).	Guidelines for measurement uncertainty used in new test procedures that include a humidity generator. This final rule cites the reference document in additional places in the regulation.

In accordance with the requirements of 1 CFR 51.5, we are incorporating by reference the use of EPA's Greenhouse gas Emissions Model (GEM) Phase 2, Version 4.0. The referenced model may

be obtained through the EPA website ([www.epa.gov](http://www.epa.gov)) or by emailing [complianceinfo@epa.gov](mailto:complianceinfo@epa.gov). As described in section III.C.1.iv of this preamble, we are moving the powertrain testing

provisions of 40 CFR 1037.550 to 40 CFR 1036.545, including references to U.S. EPA's Greenhouse gas Emissions Model (GEM). We are therefore removing GEM references in 40 CFR

1037.550, with the change noted in 40 CFR 1037.810(d)(4). We are accordingly incorporating by reference GEM as follows:

Standard or Test Method	Regulation	Summary
EPA's Greenhouse gas Emissions Model (GEM) Phase 2, Version 4.0.	40 CFR 1036.545(a)(3) and 1036.810(e)(1).	Model used for demonstrating compliance with the CO <sub>2</sub> emission standards for heavy-duty highway engines and vehicles. This final rule cites the reference document in additional places in the regulation.

*J. Executive Order 12898: Federal Actions to Address Environmental Justice in Minority Populations and Low-Income Populations and Executive Order 14096: Revitalizing Our Nation's Commitment to Environmental Justice for All*

EPA believes that the human health or environmental conditions that exist prior to this action result in or have the potential to result in disproportionate and adverse human health or environmental effects on communities with environmental justice concerns. EPA provides a summary of the evidence for potentially disproportionate and adverse effects among people of color and low-income populations in section VI.D of the preamble for this rule.

EPA believes that this action is likely to reduce existing disproportionate and adverse effects on many communities with environmental justice concerns.

Section VI.D.1 discusses the environmental justice issues associated with climate change. People of color, low-income populations and/or indigenous peoples may be especially vulnerable to the impacts of climate change. The GHG emission reductions from this action will contribute to efforts to reduce the probability of severe impacts related to climate change.

In addition to reducing GHGs, we project that this action will also reduce onroad emissions of criteria pollutants and air toxics. Section V of this preamble presents the estimated impacts from this action on onroad, refinery and EGU emissions. These non-GHG emission reductions from vehicles will improve air quality for the people who reside in close proximity to major roadways and who are disproportionately represented by people of color and people with low income, as described in section VI.D.3 of this preamble. We expect that localized increases in criteria and toxic pollutant emissions from EGUs and reductions in petroleum-sector emissions could lead to changes in

exposure to these pollutants for people living in the communities near these facilities. Analyses of communities in close proximity to these sources (such as EGUs and refineries) have found that a higher percentage of communities of color and low-income communities live near these sources when compared to national averages.

EPA is additionally identifying and addressing environmental justice concerns by providing just treatment and meaningful involvement with environment justice groups in soliciting input, considering comments, and developing this final rulemaking.

The information supporting this impacts review is contained in section VI.D of the preamble for this rule, and all supporting documents have been placed in the public docket for this action.

*K. Congressional Review Act (CRA)*

This action is subject to the CRA, and the EPA will submit a rule report to each House of the Congress and to the Comptroller General of the United States. This action meets the criteria set forth in 5 U.S.C. 804(2).

*L. Judicial Review*

This final action is “nationally applicable” within the meaning of CAA section 307(b)(1) because it is expressly listed in the section (*i.e.*, “any standard under section [202] of this title”). Under section 307(b)(1) of the CAA, petitions for judicial review of this action must be filed in the U.S. Court of Appeals for the District of Columbia Circuit within 60 days from the date this final action is published in the **Federal Register**. Filing a petition for reconsideration by the Administrator of this final action does not affect the finality of the action for the purposes of judicial review, nor does it extend the time within which a petition for judicial review must be filed and shall not postpone the effectiveness of such rule or action.

*M. Severability*

This final rule includes new and revised requirements for numerous provisions under various aspects of the highway on-road emission control program, including certain revised GHG standards for MY 2027 and new GHG standards for MYs 2028 through 2032 and later for HD vehicles, updates to discrete elements of the ABT program, emission-related warranty, and other requirements. Therefore, this final rule is a multifaceted rule that addresses many separate things for independent reasons, as detailed in each respective portion of this preamble. We intend each portion of this rule to be severable from each other, though we took the approach of including all the parts in one rulemaking rather than promulgating multiple rules to ensure the changes are consistently implemented, even though the changes are not inter-dependent. We have noted the independence of various pieces of this package both in the proposal and in earlier sections of the preamble but we reiterate it here for clarity.

For example, EPA notes that our judgments regarding feasibility of the Phase 3 standards for earlier years largely reflect anticipated changes in the heavy-duty vehicle market (which are driven by other factors, such as the IRA and manufacturers' plans), while our judgments regarding feasibility of the standards in later years reflect those trends plus the additional lead time for further adoption of control technologies. Thus, the standards for the later years are feasible and appropriate even absent standards for the earlier years, and vice versa. Accordingly, EPA finds that the standards for each individual year are severable from standards for each of the other years, and that at minimum the earlier MYs (MY 2027 through MY 2029) are severable from the later MYs (MYs 2030 and later). Furthermore, EPA's revisions to certain MY 2027 standards are severable from the new MY 2028 and later standards because our analysis supports that the standards for each of the later years are feasible

and appropriate even absent the revised MY 2027 standards.

Additionally, our judgments regarding the standards for each separate vehicle category are likewise independent and do not rely on one another. For example, EPA notes that our judgments regarding feasibility of the standards for vocational vehicles reflect our judgment regarding the general availability of depot-charging infrastructure in MY 2027 and for each later model year under the modeled potential compliance pathway, and that judgment is independent of our judgment regarding standards for tractors that reflects our judgment regarding more reliance on publicly available charging infrastructure and hydrogen refueling infrastructure in MY 2030 and for each later model year under the modeled potential compliance pathway. Similarly, within the standards for vocational vehicles, our judgments regarding the feasibility of each model year of the standards for each category of vocational vehicles (LHD, MHD, and HHD) and for tractors (day cab and sleeper cab) reflect our judgments regarding the design requirements and payback analysis for each of the individual 101 vehicle types analyzed in HD TRUCS and then aggregated to the individual vehicle category, independent of those same kinds of judgments for the other vehicle categories and independent from prior MYs standards, under the modeled potential compliance pathway. Accordingly, EPA finds that the standards for each category of vocational vehicles and tractors for each individual model year are severable, including from the standards for all other categories for that model year, and from the standards for different model years.

Finally, EPA notes that there are changes EPA is making related to implementation of standards generally (*i.e.*, independent of the numeric stringency of the standards set in this final rule). For example, EPA is making changes to testing and other certification procedures, as well as establishing battery durability and battery warranty provisions. For another example, EPA is making changes to discrete elements of the existing ABT program, including to use of credits generated from Phase 2 credit multipliers for advanced technologies and credit transfers across averaging sets. Each of these issues has been considered and adopted independently of the level of the standards, and indeed of each other. EPA's overall vehicle program continues to be fully implementable even in the absence of any one or more of these

elements. For instance, while the battery durability and warranty provisions support the implementation of the standards, EPA adopted the standards independent of those provisions, and the standards can function absent them. Likewise, while credits from multipliers and credit transfers across averaging sets allow flexibility in compliance options for manufacturers, they are not necessary for manufacturers to meet the emissions standards and we did not rely on them in justifying the feasibility of the standards.

Thus, EPA has independently considered and adopted each of these portions of the final rule (including but not limited to the Phase 3 GHG standards for HD vehicles; updates to discrete elements of the ABT program, including temporary transitional flexibilities; compliance testing and certification procedures; battery durability monitoring; and battery warranty) and each is severable should there be judicial review. If a court were to invalidate any one of these elements of the final rule, we intend the remainder of this action to remain effective. Importantly, we have designed these different elements of the program to function sensibly and independently, the supporting basis for each of these elements of the final rule reflects that they are independently justified and appropriate, and find each portion appropriate even if one or more other parts of the rule has been set aside. For example, if a reviewing court were to invalidate any of the Phase 3 GHG standards, the other regulatory amendments, including not only the other Phase 3 GHG standards but also the changes to discrete elements of the ABT program, certification procedures, and battery durability and warranty, remain fully operable. Moreover, this list is not intended to be exhaustive, and should not be viewed as an intention by EPA to consider other parts of the rule not explicitly listed here as not severable from other parts of the rule.

**XI. Statutory Authority and Legal Provisions**

Statutory authority for this action is found in the Clean Air Act at 42 U.S.C. 7401–7675, including Clean Air Act sections 202–208, 213, 216, and 301 (42 U.S.C. 7521–7542, 7547, 7550, and 7601). Statutory authority for the GHG standards is found in CAA section 202(a)(1)–(2) (42 U.S.C. 7521(a)(1)–(2)), which requires EPA to establish standards applicable to emissions of air pollutants from new motor vehicles and new motor vehicle engines which cause or contribute to air pollution which may reasonably be anticipated to endanger

public health or welfare. The statutory authorities for specific elements of this action are further described in the corresponding preamble sections.

**List of Subjects**

*40 CFR Part 86*

Environmental protection, Administrative practice and procedure, Confidential business information, Greenhouse gases, Labeling, Motor vehicle pollution, Reporting and recordkeeping requirements, Warranties.

*40 CFR Part 1036*

Environmental protection, Administrative practice and procedure, Air pollution control, Confidential business information, Greenhouse gases, Incorporation by reference, Labeling, Motor vehicle pollution, Reporting and recordkeeping requirements, Warranties.

*40 CFR Part 1037*

Environmental protection, Administrative practice and procedure, Air pollution control, Confidential business information, Incorporation by reference, Labeling, Motor vehicle pollution, Reporting and recordkeeping requirements, Warranties.

*40 CFR Part 1039*

Environmental protection, Administrative practice and procedure, Air pollution control, Confidential business information, Labeling, Motor vehicle pollution, Reporting and recordkeeping requirements, Warranties.

*40 CFR Part 1054*

Environmental protection, Administrative practice and procedure, Air pollution control, Confidential business information, Imports, Labeling, Penalties, Reporting and recordkeeping requirements, Warranties.

*40 CFR Part 1065*

Environmental protection, Administrative practice and procedure, Air pollution control, Incorporation by reference, Reporting and recordkeeping requirements, Research.

**Michael S. Regan,**  
*Administrator.*

For the reasons set out in the preamble, we are amending title 40, chapter I of the Code of Federal Regulations as set forth below.

**PART 86—CONTROL OF EMISSIONS FROM NEW AND IN-USE HIGHWAY VEHICLES AND ENGINES**

■ 1. The authority citation for part 86 continues to read as follows:

**Authority:** 42 U.S.C. 7401–7671q.

■ 2. Amend § 86.1819–14 by revising paragraph (d)(2)(i) and adding paragraph (d)(2)(iv) to read as follows:

**§ 86.1819–14 Greenhouse gas emission standards for heavy-duty vehicles.**

\* \* \* \* \*

(d) \* \* \*

(2) \* \* \*

(i) Except as specified in paragraph (d)(2)(iv) of this section, credits you generate under this section may be used only to offset credit deficits under this section. You may bank credits for use in a future model year in which your average CO<sub>2</sub> level exceeds the standard. You may trade credits to another manufacturer according to § 86.1865–12(k)(8). Before you bank or trade credits, you must apply any available credits to offset a deficit if the deadline to offset that credit deficit has not yet passed.

\* \* \* \* \*

(iv) Credits generated under this section may be used to demonstrate to compliance with the CO<sub>2</sub> emission standards for vehicles certified under 40 CFR part 1037 as described in 40 CFR 1037.150(z).

\* \* \* \* \*

**PART 1036—CONTROL OF EMISSIONS FROM NEW AND IN-USE HEAVY-DUTY HIGHWAY ENGINES**

■ 3. The authority citation for part 1036 continues to read as follows:

**Authority:** 42 U.S.C. 7401–7671q.

■ 4. Revise § 1036.101 to read as follows:

**§ 1036.101 Overview of exhaust emission standards.**

(a) You must show that engines meet the following exhaust emission standards:

(1) Criteria pollutant standards for NO<sub>x</sub>, HC, PM, and CO apply as described in § 1036.104. These pollutants are sometimes described collectively as “criteria pollutants” because they are either criteria pollutants under the Clean Air Act or precursors to the criteria pollutants ozone and PM.

(2) This part contains standards and other regulations applicable to the emission of the air pollutant defined as the aggregate group of six greenhouse gases: carbon dioxide, nitrous oxide, methane, hydrofluorocarbons, perfluorocarbons, and sulfur hexafluoride. Greenhouse gas (GHG) standards for CO<sub>2</sub>, CH<sub>4</sub>, and N<sub>2</sub>O apply as described in § 1036.108.

(b) You may optionally demonstrate compliance with the emission standards of this part by testing hybrid powertrains, rather than testing the engine alone. Except as specified, provisions of this part that reference engines apply equally to hybrid powertrains.

**§ 1036.104 [Amended]**

■ 5. Amend § 1036.104 by removing paragraph (c)(2)(iii).

■ 6. Amend § 1036.108 by revising paragraphs (a)(1) and (e) to read as follows:

**§ 1036.108 Greenhouse gas emission standards—CO<sub>2</sub>, CH<sub>4</sub>, and N<sub>2</sub>O.**

\* \* \* \* \*

(a) \* \* \*

(1) CO<sub>2</sub> emission standards in this paragraph (a)(1) apply based on testing as specified in subpart F of this part. The applicable test cycle for measuring CO<sub>2</sub> emissions differs depending on the engine family’s primary intended service class and the extent to which the engines will be (or were designed to be) used in tractors. For Medium HDE and

Heavy HDE certified as tractor engines, measure CO<sub>2</sub> emissions using the SET steady-state duty cycle specified in § 1036.510. This testing with the SET duty cycle is intended for engines designed to be used primarily in tractors and other line-haul applications. Note that the use of some SET-certified tractor engines in vocational applications does not affect your certification obligation under this paragraph (a)(1); see other provisions of this part and 40 CFR part 1037 for limits on using engines certified to only one cycle. For Medium HDE and Heavy HDE certified as both tractor and vocational engines, measure CO<sub>2</sub> emissions using the SET duty cycle specified in § 1036.510 and the FTP transient duty cycle specified in § 1036.512. Testing with both SET and FTP duty cycles is intended for engines that are designed for use in both tractor and vocational applications. For all other engines (including Spark-ignition HDE), measure CO<sub>2</sub> emissions using the FTP transient duty cycle specified in § 1036.512.

(i) *Spark-ignition standards.* The CO<sub>2</sub> standard for all spark-ignition engines is 627 g/hp-hr for model years 2016 through 2020. This standard continues to apply in later model years for all spark-ignition engines that are not Heavy HDE. Spark-ignition engines that qualify as Heavy HDE under § 1036.140(b)(2) for model years 2021 and later are subject to the compression-ignition engine standards for Heavy HDE-Vocational or Heavy HDE-Tractor, as applicable. You may certify spark-ignition engines to the compression-ignition standards for the appropriate model year under this paragraph (a). If you do this, those engines are treated as compression-ignition engines for all provisions of this part.

(ii) *Compression-ignition standards.* The following CO<sub>2</sub> standards apply for compression-ignition engines and model year 2021 and later spark-ignition engines that qualify as Heavy HDE:

TABLE 1 TO PARAGRAPH (a)(1)(ii) OF § 1036.108—COMPRESSION-IGNITION CO<sub>2</sub> STANDARDS [g/hp-hr]

Phase	Model years	Light HDE	Medium HDE-vocational	Heavy HDE-vocational	Medium HDE-tractor	Heavy HDE-tractor
1	2014–2016	600	600	567	502	475
	2017–2020	576	576	555	487	460
2	2021–2023	563	545	513	473	447
	2024–2026	555	538	506	461	436
	2027 and later	552	535	503	457	432

\* \* \* \* \*

(e) *Applicability for testing.* The emission standards in this subpart apply

as specified in this paragraph (e) to all duty-cycle testing (according to the

applicable test cycles) of testable configurations, including certification, selective enforcement audits, and in-use testing. The CO<sub>2</sub> FCLs serve as the CO<sub>2</sub> emission standards for the engine family with respect to certification and confirmatory testing instead of the standards specified in paragraph (a)(1) of this section. The FELs serve as the emission standards for the engine family with respect to all other duty-cycle testing. See §§ 1036.235 and 1036.241 to determine which engine configurations within the engine family are subject to testing. Note that engine fuel maps and powertrain test results also serve as standards as described in §§ 1036.535, 1036.540, 1036.545, and 1036.630.

■ 7. Amend § 1036.110 by revising paragraphs (b) introductory text, (b)(6), (b)(9) introductory text, (b)(11)(ii), and (c)(1) to read as follows:

**§ 1036.110 Diagnostic controls.**

(b) Engines must comply with the 2019 heavy-duty OBD requirements adopted for California as described in this paragraph (b). California's 2019 heavy-duty OBD requirements are part of 13 CCR 1968.2, 1968.5, 1971.1, and 1971.5 (incorporated by reference, see § 1036.810). We may approve your request to certify an OBD system meeting alternative specifications if you submit information as needed to demonstrate that it meets the intent of this section. For example, we may approve your request for a system that meets a later version of California's OBD requirements if you demonstrate that it meets the intent of this section; the demonstration must include identification of any approved deficiencies and your plans to resolve such deficiencies. To demonstrate that your engine meets the intent of this section, the OBD system meeting alternative specifications must address all the provisions described in this paragraph (b) and in paragraph (c) of this section. The following clarifications and exceptions apply for engines certified under this part:

(6) The provisions related to verification of in-use compliance in 13 CCR 1971.1(l)(4) do not apply. The provisions related to manufacturer self-testing in 13 CCR 1971.5(c) also do not apply.

(9) Design compression-ignition engines to make the following additional data-stream signals available on demand with a generic scan tool according to 13 CCR 1971.1(h)(4.2), if the engine is so equipped with the

relevant components and OBD monitoring is required for those components (or modeling is required for some parameter related to those components):

- \* \* \* \* \*
- (11) \* \* \*
- (ii) Send us results from any testing you performed for certifying engine families (including equivalent engine families) with the California Air Resources Board, including the results of any testing performed under 13 CCR 1971.1(l) for verification of in-use compliance and 13 CCR 1971.5(c) for manufacturer self-testing within the deadlines set out in 13 CCR 1971.1 and 1971.5.
- \* \* \* \* \*
- (c) \* \* \*

(1) For inducements specified in § 1036.111 and any other AECD that derates engine output related to SCR or DPF systems, indicate the fault code for the detected problem, a description of the fault code, and the current speed restriction. For inducement faults under § 1036.111, identify whether the fault condition is for DEF level, DEF quality, or tampering; for other faults, identify whether the fault condition is related to SCR or DPF systems. If there are additional derate stages, also indicate the next speed restriction and the time remaining until starting the next restriction. If the derate involves something other than restricting vehicle speed, such as a torque derate, adjust the information to correctly identify any current and pending restrictions.

■ 8. Revise and republish § 1036.111 to read as follows:

**§ 1036.111 Inducements related to SCR.**

Engines using SCR to control emissions depend on a constant supply of diesel exhaust fluid (DEF). This section describes how manufacturers must design their engines to derate power output to induce operators to take appropriate actions to ensure the SCR system is working properly. The requirements of this section apply equally for engines installed in heavy-duty vehicles at or below 14,000 lbs GVWR. The requirements of this section apply starting in model year 2027, though you may comply with the requirements of this section in earlier model years.

(a) *General provisions.* The following terms and general provisions apply under this section:

(1) As described in § 1036.110, this section relies on terms and requirements specified for OBD systems by California ARB in 13 CCR 1968.2 and 1971.1

(incorporated by reference, see § 1036.810).

(2) The provisions of this section apply differently based on an individual vehicle's speed history. A vehicle's speed category is based on the OBD system's recorded value for average speed for the preceding 30 hours of non-idle engine operation. The vehicle speed category applies at the point that the engine first detects an inducement triggering condition identified under paragraph (b) of this section and continues to apply until the inducement triggering condition is fully resolved as specified in paragraph (e) of this section. Non-idle engine operation includes all operating conditions except those that qualify as idle based on OBD system controls as specified in 13 CCR 1971.1(h)(5.4.10). Apply speed derates based on the following categories:

TABLE 1 TO PARAGRAPH (a)(2) OF § 1036.111—VEHICLE CATEGORIES

Vehicle category <sup>a</sup>	Average speed (mi/hr)
Low-speed .....	speed <15.
Medium-speed .....	15 ≤ speed <25.
High-speed .....	speed ≥25.

<sup>a</sup>A vehicle is presumed to be a high-speed vehicle if it has not yet logged 30 hours of non-idle operation.

(3) Where engines derate power output as specified in this section, the derate must decrease vehicle speed by 1 mi/hr for every five minutes of engine operation until reaching the specified derate speed. This paragraph (a)(3) applies at the onset of an inducement, at any transition to a different step of inducement, and for any derate that recurs under paragraph (e)(3) of this section.

(b) *Inducement triggering conditions.* Create derate strategies that monitor for and trigger an inducement based on the following conditions:

- (1) DEF supply falling to 2.5 percent of DEF tank capacity or a level corresponding to three hours of engine operation, based on available information on DEF consumption rates.
- (2) DEF quality failing to meet your concentration specifications.
- (3) Any signal indicating that a catalyst is missing.
- (4) Open circuit faults related to the following: DEF tank level sensor, DEF pump, DEF quality sensor, SCR wiring harness, NO<sub>x</sub> sensors, DEF dosing valve, DEF tank heater, DEF tank temperature sensor, and aftertreatment control module.
- (c) [Reserved]
- (d) *Derate schedule.* Engines must follow the derate schedule described in

this paragraph (d) if the engine detects an inducement triggering condition identified in paragraph (b) of this section. The derate takes the form of a

maximum drive speed for the vehicle. This maximum drive speed decreases over time based on hours of non-idle

engine operation without regard to engine starting.  
 (1) Apply speed-limiting derates according to the following schedule:

TABLE 2 TO PARAGRAPH (d)(1) OF § 1036.111—DERATE SCHEDULE FOR DETECTED INDUCEMENT TRIGGERING CONDITIONS <sup>a</sup>

High-speed vehicles		Medium-speed vehicles		Low-speed vehicles	
Hours of non-idle engine operation	Maximum speed (mi/hr)	Hours of non-idle engine operation	Maximum speed (mi/hr)	Hours of non-idle engine operation	Maximum speed (mi/hr)
0	65	0	55	0	45
6	60	6	50	5	40
12	55	12	45	10	35
20	50	45	40	30	25
86	45	70	35	.....	.....
119	40	90	25	.....	.....
144	35	.....	.....	.....	.....
164	25	.....	.....	.....	.....

<sup>a</sup> Hours start counting when the engine detects an inducement triggering condition specified in paragraph (b) of this section. For DEF supply, you may program the engine to reset the timer to three hours when the engine detects an empty DEF tank.

(2) You may design and produce engines that will be installed in motorcoaches with an alternative derate schedule that starts with a 65 mi/hr derate when an inducement triggering condition is first detected, steps down to 50 mi/hr after 80 hours, and concludes with a final derate speed of 25 mi/hr after 180 hours of non-idle operation.

(e) *Deactivating derates.* Program the engine to deactivate derates as follows:  
 (1) Evaluate whether the detected inducement triggering condition continues to apply. Deactivate derates if the engine confirms that the detected inducement triggering condition is resolved.

(2) Allow a generic scan tool to deactivate inducement triggering codes while the vehicle is not in motion.

(3) Treat any detected inducement triggering condition that recurs within 40 hours of engine operation as the same detected inducement triggering condition, which would restart the derate at the same point in the derate schedule that the system last deactivated the derate.

■ 9. Amend § 1036.115 by revising paragraph (h)(4) to read as follows:

**§ 1036.115 Other requirements.**

\* \* \* \* \*

(h) \* \* \*

(4) The AECd applies only for engines that will be installed in *emergency vehicles*, and the need is justified in terms of preventing the engine from losing speed, torque, or power due abnormal conditions of the emission control system, or in terms of preventing such abnormal conditions from occurring, during operation related to emergency response. Examples of such

abnormal conditions may include excessive exhaust backpressure from an overloaded particulate trap, and running out of diesel exhaust fluid for engines that rely on urea-based selective catalytic reduction. The emission standards do not apply when any AECds approved under this paragraph (h)(4) are active.

\* \* \* \* \*

■ 10. Amend § 1036.120 by revising paragraph (c) to read as follows:

**§ 1036.120 Emission-related warranty requirements.**

\* \* \* \* \*

(c) *Components covered.* The emission-related warranty covers all components listed in 40 CFR part 1068, appendix A, and components from any other system you develop to control emissions. Note that this includes hybrid system components that you specify in a certified configuration. The emission-related warranty covers any components, regardless of the company that produced them, that are the original components or the same design as components from the certified configuration.

\* \* \* \* \*

■ 11. Amend § 1036.125 by revising paragraph (h)(8)(iii) to read as follows:

**§ 1036.125 Maintenance instructions and allowable maintenance.**

\* \* \* \* \*

(h) \* \* \*

(8) \* \* \*

(iii) A description of the three types of SCR-related derates (DEF level, DEF quality and tampering) and that further information on the inducement cause

(e.g., trouble codes) is available using the OBD system.

\* \* \* \* \*

- 12. Amend § 1036.150 by:
- a. Revising paragraphs (a)(2)(ii) and (d);
- b. Adding paragraph (f);
- c. Revising paragraphs (j), (k) introductory text, (q), and (v); and
- d. Adding paragraph (aa).

The additions and revisions read as follows:

**§ 1036.150 Interim provisions.**

\* \* \* \* \*

(a) \* \* \*

(2) \* \* \*

(ii) Engines must meet a NO<sub>x</sub> standard when tested over the Low Load Cycle as described in § 1036.514. Engines must also meet an off-cycle NO<sub>x</sub> standard as specified in § 1036.104(a)(3). Calculate the NO<sub>x</sub> family emission limits for the Low Load Cycle and for off-cycle testing as described in § 1036.104(c)(3) with *Std*<sub>FTPNO<sub>x</sub></sub> set to 35 mg/hp-hr and *Std*<sub>[cycle]NO<sub>x</sub></sub> set to the values specified in § 1036.104(a)(1) or (3), respectively. No standard applies for HC, PM, and CO emissions for the Low Load Cycle or for off-cycle testing, but you must record measured values for those pollutants and include those measured values where you report NO<sub>x</sub> emission results.

\* \* \* \* \*

(d) *Small manufacturers.* The greenhouse gas standards of this part apply on a delayed schedule for manufacturers meeting the small business criteria specified in 13 CFR 121.201. Apply the small business criteria for NAICS code 336310 for engine manufacturers with respect to



gasoline-fueled engines and 333618 for engine manufacturers with respect to other engines; the employee limits apply to the total number employees together for affiliated companies. Qualifying small manufacturers are not subject to the greenhouse gas emission standards in § 1036.108 for engines with a date of manufacture on or after November 14, 2011, but before January 1, 2022. In addition, qualifying small manufacturers producing engines that run on any fuel other than gasoline, E85, or diesel fuel may delay complying with every later greenhouse gas standard under this part by one model year; however, small manufacturers may generate emission credits only by certifying all their engine families within a given averaging set to standards that apply for the current model year. Note that engines not yet subject to standards must nevertheless supply fuel maps to vehicle manufacturers as described in paragraph (n) of this section. Note also that engines produced by small manufacturers are subject to criteria pollutant standards.

(f) *Testing exemption for hydrogen engines.* Tailpipe CO<sub>2</sub> emissions from engines fueled with neat hydrogen are deemed to be 3 g/hp-hr and tailpipe CH<sub>4</sub>, HC, and CO emissions are deemed to comply with the applicable standard. Fuel mapping and testing for CO<sub>2</sub>, CH<sub>4</sub>, HC, or CO is optional under this part for these engines.

(j) *Alternate standards under 40 CFR part 86.* This paragraph (j) describes alternate emission standards that apply for model year 2023 and earlier loose engines certified under 40 CFR 86.1819–14(k)(8). The standards of § 1036.108 do not apply for these engines. The standards in this paragraph (j) apply for emissions measured with the engine installed in a complete vehicle consistent with the provisions of 40 CFR 86.1819–14(k)(8)(vi). The only requirements of this part that apply to these engines are those in this paragraph (j) and §§ 1036.115 through 1036.135, 1036.535, and 1036.540.

(k) *Limited production volume allowance under ABT.* You may produce a limited number of Heavy HDE that continue to meet the standards that applied under 40 CFR 86.007–11 in model years 2027 through 2029. The maximum number of engines you may produce under this limited production allowance is 5 percent of the annual average of your actual production volume of Heavy HDE in model years 2023–2025 for calculating emission credits under § 1036.705. Engine

certification under this paragraph (k) is subject to the following conditions and requirements:

(q) *Confirmatory and in-use testing of fuel maps defined in § 1036.505(b).* For model years 2021 and later, where the results from Eq. 1036.235–1 for a confirmatory or in-use test are at or below 2.0%, we will not replace the manufacturer’s fuel maps.

(v) *OBD communication protocol.* We may approve the alternative communication protocol specified in SAE J1979–2 (incorporated by reference, see § 1036.810) if the protocol is approved by the California Air Resources Board. The alternative protocol would apply instead of SAE J1939 and SAE J1979 as specified in 40 CFR 86.010–18(k)(1). Engines designed to comply with SAE J1979–2 must meet the freeze-frame requirements in § 1036.110(b)(8) and in 13 CCR 1971.1(h)(4.3.2) (incorporated by reference, see § 1036.810). This paragraph (v) also applies for model year 2026 and earlier engines.

(aa) *Correcting credit calculations.* If you notify us by October 1, 2024, that errors mistakenly decreased your balance of GHG emission credits for 2020 or any earlier model years, you may correct the errors and recalculate the balance of emission credits after applying a 10 percent discount to the credit correction.

■ 13. Amend § 1036.205 by revising paragraph (v) to read as follows:

**§ 1036.205 Requirements for an application for certification.**

(v) Include good-faith estimates of U.S.-directed production volumes. Include a justification for the estimated production volumes if they are substantially different than actual production volumes in earlier years for similar models.

■ 14. Amend § 1036.230 by revising paragraph (e) to read as follows:

**§ 1036.230 Selecting engine families.**

(e) Engine configurations certified as hybrid powertrains may not be included in an engine family with engines that have nonhybrid powertrains. Note that this does not prevent you from including engines in a nonhybrid family if they are used in hybrid vehicles, as long as you certify them based on engine testing.

■ 15. Amend § 1036.240 by revising paragraph (c)(3) to read as follows:

**§ 1036.240 Demonstrating compliance with criteria pollutant emission standards.**

(c) (3) *Sawtooth and other nonlinear deterioration patterns.* The deterioration factors described in paragraphs (c)(1) and (2) of this section assume that the highest useful life emissions occur either at the end of useful life or at the low-hour test point. The provisions of this paragraph (c)(3) apply where good engineering judgment indicates that the highest useful life emissions will occur between these two points. For example, emissions may increase with service accumulation until a certain maintenance step is performed, then return to the low-hour emission levels and begin increasing again. Such a pattern may occur with battery-based hybrid powertrains. Base deterioration factors for engines with such emission patterns on the difference between (or ratio of) the point at which the highest emissions occur and the low-hour test point. Note that this paragraph (c)(3) applies for maintenance-related deterioration only where we allow such critical emission-related maintenance.

■ 16. Amend § 1036.241 by revising paragraph (c)(3) to read as follows:

**§ 1036.241 Demonstrating compliance with greenhouse gas emission standards.**

(c) (3) *Sawtooth and other nonlinear deterioration patterns.* The deterioration factors described in paragraphs (c)(1) and (2) of this section assume that the highest useful life emissions occur either at the end of useful life or at the low-hour test point. The provisions of this paragraph (c)(3) apply where good engineering judgment indicates that the highest useful life emissions will occur between these two points. For example, emissions may increase with service accumulation until a certain maintenance step is performed, then return to the low-hour emission levels and begin increasing again. Such a pattern may occur with battery-based hybrid powertrains. Base deterioration factors for engines with such emission patterns on the difference between (or ratio of) the point at which the highest emissions occur and the low-hour test point. Note that this paragraph (c)(3) applies for maintenance-related deterioration only where we allow such critical emission-related maintenance.

■ 17. Amend § 1036.245 by revising paragraphs (c)(3) introductory text and (c)(3)(ii) introductory text to read as follows:

**§ 1036.245 Deterioration factors for exhaust emission standards.**

\* \* \* \* \*

(c) \* \* \*

(3) Perform service accumulation in the laboratory by operating the engine or hybrid powertrain repeatedly over one of the following test sequences, or a different test sequence that we approve in advance:

\* \* \* \* \*

(ii) Duty-cycle sequence 2 is based on operating over the LLC and the vehicle-based duty cycles from 40 CFR part 1037. Select the vehicle subcategory and vehicle configuration from § 1036.540 or § 1036.545 with the highest reference cycle work for each vehicle-based duty cycle. Operate the engine as follows for duty-cycle sequence 2:

\* \* \* \* \*

■ 18. Amend § 1036.250 by revising paragraph (a) to read as follows:

**§ 1036.250 Reporting and recordkeeping for certification.**

(a) By September 30 following the end of the model year, send the Designated Compliance Officer a report including the total U.S.-directed production volume of engines you produced in each engine family during the model year (based on information available at the time of the report). Report the production by serial number and engine configuration. You may combine this report with reports required under subpart H of this part. We may waive the reporting requirements of this paragraph (a) for small manufacturers.

\* \* \* \* \*

■ 19. Amend § 1036.301 by revising paragraph (c) to read as follows:

**§ 1036.301 Measurements related to GEM inputs in a selective enforcement audit.**

\* \* \* \* \*

(c) If your certification includes powertrain testing as specified in § 1036.630, these selective enforcement audit provisions apply with respect to powertrain test results as specified in § 1036.545 and 40 CFR part 1037, subpart D. We may allow manufacturers to instead perform the engine-based testing to simulate the powertrain test as specified in 40 CFR 1037.551.

\* \* \* \* \*

■ 20. Amend § 1036.405 by revising paragraphs (a) and (d) to read as follows:

**§ 1036.405 Overview of the manufacturer-run field-testing program.**

(a) You must test in-use engines from the families we select. We may select the following number of engine families for testing, except as specified in paragraph (b) of this section:

(1) We may select up to 25 percent of your engine families in any calendar year, calculated by dividing the number of engine families you certified in the model year corresponding to the calendar year by four and rounding to the nearest whole number. We will consider only engine families with annual U.S.-directed production volumes above 1,500 units in calculating the number of engine families subject to testing each calendar year under the annual 25 percent engine family limit. If you have only three or fewer families that each exceed an annual U.S.-directed production volume of 1,500 units, we may select one engine family per calendar year for testing.

(2) Over any four-year period, we will not select more than the average number of engine families that you have certified over that four-year period (the model year when the selection is made and the preceding three model years), based on rounding the average value to the nearest whole number.

(3) We will not select engine families for testing under this subpart from a given model year if your total U.S.-directed production volume was less than 100 engines.

\* \* \* \* \*

(d) You must complete all the required testing and reporting under this subpart (for all ten test engines, if applicable), within 18 months after we direct you to test a particular engine family. We will typically select engine families for testing and notify you in writing by June 30 of the applicable calendar year. If you request it, we may allow additional time to send us this information.

\* \* \* \* \*

■ 21. Amend § 1036.415 by revising paragraph (c)(1) to read as follows:

**§ 1036.415 Preparing and testing engines.**

\* \* \* \* \*

(c) \* \* \*

(1) You may use any diesel fuel that meets the specifications for S15 in ASTM D975 (incorporated by reference, see § 1036.810). You may use any commercially available biodiesel fuel blend that meets the specifications for ASTM D975 or ASTM D7467 (incorporated by reference, see § 1036.810) that is either expressly allowed or not otherwise indicated as an unacceptable fuel in the vehicle's owner or operator manual or in the engine manufacturer's published fuel recommendations. You may use any gasoline fuel that meets the specifications in ASTM D4814 (incorporated by reference, see § 1036.810). For other fuel types, you may use any commercially available fuel.

\* \* \* \* \*

■ 22. Amend § 1036.420 by revising paragraph (a) to read as follows:

**§ 1036.420 Pass criteria for individual engines.**

\* \* \* \* \*

(a) Determine the emission standard for each regulated pollutant for each bin by adding the following accuracy margins for PEMS to the off-cycle standards in § 1036.104(a)(3):

TABLE 1 TO PARAGRAPH (a) OF § 1036.420—ACCURACY MARGINS FOR IN-USE TESTING

	NO <sub>x</sub>	HC	PM	CO
Bin 1 .....	0.4 g/hr.			
Bin 2 .....	5 mg/hp-hr .....	10 mg/hp-hr .....	6 mg/hp-hr .....	0.25 g/hp-hr.

\* \* \* \* \*

■ 23. Amend § 1036.501 by revising paragraphs (e) and (f) and adding paragraphs (g) and (h) to read as follows:

**§ 1036.501 General testing provisions.**

\* \* \* \* \*

(e) You may disable any AECs that have been approved solely for emergency equipment applications under § 1036.115(h)(4). Note that the emission standards do not apply when any of these AECs are active.

(f) You may use special or alternate procedures to the extent we allow them under 40 CFR 1065.10.

(g) This subpart is addressed to you as a manufacturer, but it applies equally to anyone who does testing for you, and to us when we perform testing to

determine if your engines meet emission standards.

(h) For testing engines that use regenerative braking through the crankshaft only to power an electric heater for aftertreatment devices, you may use the nonhybrid engine testing procedures in §§ 1036.510, 1036.512, and 1036.514 and you may also or instead use the fuel mapping procedure in § 1036.505(b)(1) or (2). You may use this allowance only if the recovered energy is less than 10 percent of the total positive work for each applicable test interval. Otherwise, use powertrain testing procedures specified for hybrid powertrains to measure emissions and create fuel maps. For engines that power an electric heater with a battery, you must meet the requirements related to charge-sustaining operation as described in 40 CFR 1066.501(a)(3).

■ 24. Amend § 1036.505 by revising paragraphs (a) and (b) to read as follows:

**§ 1036.505 Engine data and information to support vehicle certification.**

\* \* \* \* \*

(a) Identify engine make, model, fuel type, combustion type, engine family name, calibration identification, and engine displacement. Also identify whether the engines meet CO<sub>2</sub> standards for tractors, vocational vehicles, or both. When certifying vehicles with GEM, for any fuel type not identified in table 1 to paragraph (b)(4) of § 1036.550, identify the fuel type as diesel fuel for engines subject to compression-ignition standards, and as gasoline for engines subject to spark-ignition standards.

(b) This paragraph (b) describes four different methods to generate engine fuel maps. For engines without hybrid components and for mild hybrid engines where you do not include hybrid components in the test, generate fuel maps using either paragraph (b)(1) or (2) of this section. For other hybrid engines, generate fuel maps using paragraph (b)(3) of this section. For hybrid powertrains and nonhybrid powertrains and for vehicles where the transmission is not automatic, automated manual, manual, or dual-clutch, generate fuel maps using paragraph (b)(4) of this section.

(1) Determine steady-state engine fuel maps as described in § 1036.535(b). Determine fuel consumption at idle as described in § 1036.535(c). Determine cycle-average engine fuel maps as described in § 1036.540, excluding cycle-average fuel maps for highway cruise cycles.

(2) Determine steady-state fuel maps as described in either § 1036.535(b) or (d). Determine fuel consumption at idle as described in § 1036.535(c). Determine

cycle-average engine fuel maps as described in § 1036.540, including cycle-average engine fuel maps for highway cruise cycles. We may do confirmatory testing by creating cycle-average fuel maps from steady-state fuel maps created in paragraph (b)(1) of this section for highway cruise cycles. In § 1036.540 we define the vehicle configurations for testing; we may add more vehicle configurations to better represent your engine's operation for the range of vehicles in which your engines will be installed (see 40 CFR 1065.10(c)(1)).

(3) Determine fuel consumption at idle as described in § 1036.535(c) and (d) and determine cycle-average engine fuel maps as described in § 1036.545, including cycle-average engine fuel maps for highway cruise cycles. Set up the test to apply accessory load for all operation by primary intended service class as described in the following table:

TABLE 1 TO PARAGRAPH (b)(3) OF § 1036.505—ACCESSORY LOAD

Primary intended service class	Power representing accessory load (kW)
Light HDV .....	1.5
Medium HDV .....	2.5
Heavy HDV .....	3.5

(4) Generate powertrain fuel maps as described in § 1036.545 instead of fuel mapping under § 1036.535 or § 1036.540. Note that the option in § 1036.545(b)(2) is allowed only for hybrid engine testing. Disable stop-start systems and automatic engine shutdown systems when conducting powertrain fuel map testing using § 1036.545.

\* \* \* \* \*

- 25. Amend § 1036.510 by:
  - a. Revising paragraphs (b) introductory text, (b)(2) introductory text, and (b)(2)(vii) and (viii);
  - b. Removing paragraph (b)(2)(ix); and
  - c. Revising paragraphs (c)(2) introductory text, (c)(2)(i) introductory text, and (d) through (g).

The revisions read as follows:

**§ 1036.510 Supplemental Emission Test.**

\* \* \* \* \*

(b) Procedures apply differently for testing certain kinds of engines and powertrains as follows:

\* \* \* \* \*

(2) Test hybrid powertrains as described in § 1036.545, except as specified in this paragraph (b)(2). Do not compensate the duty cycle for the distance driven as described in § 1036.545(g)(4). For hybrid engines, select the transmission from

§ 1036.540(c)(2), substituting “engine” for “vehicle” and “highway cruise cycle” for “SET”. Disregard duty cycles in § 1036.545(j). For cycles that begin with idle, leave the transmission in neutral or park for the full initial idle segment. Place the transmission into drive no earlier than 5 seconds before the first nonzero vehicle speed setpoint. For SET testing only, place the transmission into park or neutral when the cycle reaches the final idle segment. Use the following vehicle parameters instead of those in § 1036.545 to define the vehicle model in § 1036.545(a)(3):

\* \* \* \* \*

(vii) Select a combination of drive axle ratio,  $k_a$ , and a tire radius,  $r$ , that represents the worst-case combination of top gear ratio, drive axle ratio, and tire size for CO<sub>2</sub> expected for vehicles in which the hybrid engine or hybrid powertrain will be installed. This is typically the highest axle ratio and smallest tire radius. Disregard configurations or settings corresponding to a maximum vehicle speed below 60 mi/hr in selecting a drive axle ratio and tire radius, unless you can demonstrate that in-use vehicles will not exceed that speed. You may request preliminary approval for selected drive axle ratio and tire radius consistent with the provisions of § 1036.210. If the hybrid engine or hybrid powertrain is used exclusively in vehicles not capable of reaching 60 mi/hr, you may request that we approve an alternate test cycle and cycle-validation criteria as described in 40 CFR 1066.425(b)(5). Note that hybrid engines rely on a specified transmission that is different for each duty cycle; the transmission's top gear ratio therefore depends on the duty cycle, which will in turn change the selection of the drive axle ratio and tire size. For example, § 1036.520 prescribes a different top gear ratio than this paragraph (b)(2).

(viii) If you are certifying a hybrid engine, use a default transmission efficiency of 0.95 and create the vehicle model along with its default transmission shift strategy as described in § 1036.545(a)(3)(ii). Use the transmission parameters defined in § 1036.540(c)(2) to determine transmission type and gear ratio. For Light HDV and Medium HDV, use the Light HDV and Medium HDV parameters for FTP, LLC, and SET duty cycles. For Tractors and Heavy HDVs, use the Tractor and Heavy HDV transient cycle parameters for the FTP and LLC duty cycles and the Tractor and Heavy HDV highway cruise cycle parameters for the SET duty cycle.

(c) \* \* \*

(2) The duty cycle for testing hybrid powertrains involves a schedule of vehicle speeds and road grade as follows:

(i) Determine road grade at each point based on the continuous rated power of the hybrid powertrain,  $P_{\text{contrated}}$ , in kW determined in § 1036.520, the vehicle speed (A, B, or C) in mi/hr for a given SET mode,  $V_{\text{ref[ speed]}}$ , and the specified road-grade coefficients using the following equation:

\* \* \* \* \*

(d) Determine criteria pollutant emissions for plug-in hybrid powertrains as follows:

(1) Carry out a charge-sustaining test as described in paragraph (b)(2) of this section.

(2) Carry out a charge-depleting test as described in paragraph (b)(2) of this section, except as follows:

(i) Fully charge the RESS after preconditioning.  
 (ii) Operate the engine or powertrain continuously over repeated SET duty cycles until you reach the end-of-test criterion defined in 40 CFR 1066.501(a)(3).

(iii) Calculate emission results for each SET duty cycle. Figure 1 to paragraph (d)(4) of this section provides

an example of a charge-depleting test sequence where there are two test intervals that contain engine operation.

(3) Report the highest emission result for each criteria pollutant from all tests in paragraphs (d)(1) and (2) of this section, even if those individual results come from different test intervals.

(4) The following figure illustrates an example of an SET charge-depleting test sequence:

**Figure 1 to Paragraph (d)(4) of § 1036.510—SET Charge-Depleting Criteria Pollutant Test Sequence.**

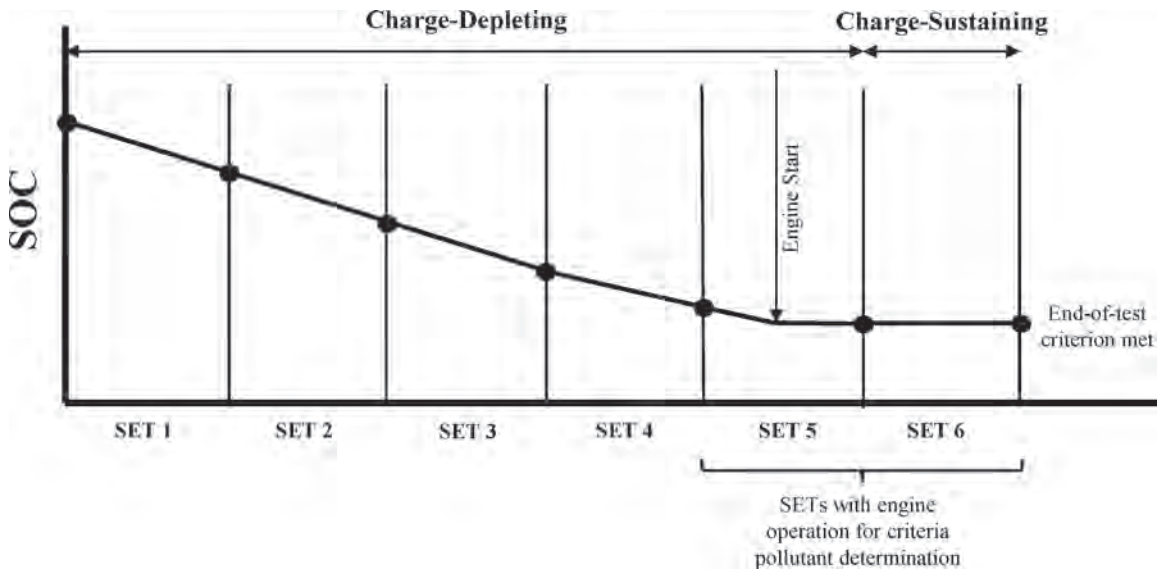

(e) Determine greenhouse gas pollutant emissions for plug-in hybrid powertrains using the emissions results for all the SET test intervals for both

charge-depleting and charge-sustaining operation from paragraph (d)(2) of this section. Calculate the utility factor-weighted composite mass of emissions

from the charge-depleting and charge-sustaining test results,  $e_{\text{UF[emission]comp}}$ , using the following equation:

$$e_{\text{UF[emission]comp}} = \frac{\sum_{i=1}^N [e_{\text{[emission][int]CDi}} \cdot (UF_{\text{DCDi}} - UF_{\text{DCDi-1}})] + \sum_{j=1}^M [e_{\text{[emission][int]CSj}}]}{(1 - UF_{\text{RCD}}) \cdot M}$$

Eq. 1036.510-10

Where:

$i$  = an indexing variable that represents one test interval.

$N$  = total number of charge-depleting test intervals.

$e_{\text{[emission][int]CDi}}$  = total mass of emissions in the charge-depleting portion of the test for each test interval,  $i$ , starting from  $i = 1$ , including the test interval(s) from the transition phase.

$UF_{\text{DCDi}}$  = utility factor fraction at distance  $D_{\text{CDi}}$  from Eq. 1036.510-11, as determined by interpolating the approved utility factor curve for each test

interval,  $i$ , starting from  $i = 1$ . Let  $UF_{\text{DCD0}} = 0$ .

$j$  = an indexing variable that represents one test interval.

$M$  = total number of charge-sustaining test intervals.

$e_{\text{[emission][int]CSj}}$  = total mass of emissions in the charge-sustaining portion of the test for each test interval,  $j$ , starting from  $j = 1$ .

$UF_{\text{RCD}}$  = utility factor fraction at the full charge-depleting distance,  $R_{\text{CD}}$ , as determined by interpolating the approved utility factor curve.  $R_{\text{CD}}$  is the cumulative distance driven over  $N$  charge-depleting test intervals.

$$D_{\text{CDi}} = \sum_{k=1}^Q (v_k \cdot \Delta t)$$

Eq. 1036.510-11

Where:

$k$  = an indexing variable that represents one recorded velocity value.

$Q$  = total number of measurements over the test interval.

$v$  = vehicle velocity at each time step,  $k$ , starting from  $k = 1$ . For tests completed under this section,  $v$  is the vehicle velocity from the vehicle model in

§ 1036.545. Note that this should include charge-depleting test intervals that start when the engine is not yet operating.

$\Delta t = 1/f_{\text{record}}$   
 $f_{\text{record}}$  = the record rate.

*Example using the charge-depletion test in figure 1 to paragraph (d)(4) of this section for the SET for CO<sub>2</sub> emission determination:*  
 $Q = 24000$

$\omega_1 = 0$  mi/hr  
 $\omega_2 = 0.8$  mi/hr  
 $\omega_3 = 1.1$  mi/hr  
 $f_{\text{record}} = 10$  Hz  
 $\Delta t = 1/10$  Hz = 0.1 s

$$D_{\text{CD1}} = \sum_{k=1}^{24000} (0 \cdot 0.1 + 0.8 \cdot 0.1 + 1.1 \cdot 0.1 + v_{24000} \cdot \Delta t)$$

$D_{\text{CD1}} = 30.1$  mi  
 $D_{\text{CD2}} = 30.0$  mi  
 $D_{\text{CD3}} = 30.1$  mi  
 $D_{\text{CD4}} = 30.2$  mi  
 $D_{\text{CD5}} = 30.1$  mi  
 $N = 5$   
 $UF_{\text{DCD1}} = 0.11$

$UF_{\text{DCD2}} = 0.23$   
 $UF_{\text{DCD3}} = 0.34$   
 $UF_{\text{DCD4}} = 0.45$   
 $UF_{\text{DCD5}} = 0.53$   
 $e_{\text{CO2SETCD1}} = 0$  g/hp·hr  
 $e_{\text{CO2SETCD2}} = 0$  g/hp·hr  
 $e_{\text{CO2SETCD3}} = 0$  g/hp·hr

$e_{\text{CO2SETCD4}} = 0$  g/hp·hr  
 $e_{\text{CO2SETCD5}} = 174.4$  g/hp·hr  
 $M = 1$   
 $e_{\text{CO2SETCS}} = 428.1$  g/hp·hr  
 $UF_{\text{RCD}} = 0.53$

$$e_{\text{UFCO2comp}} = [0 \cdot (0.11 - 0) + 0 \cdot (0.23 - 0.11) + 0 \cdot (0.34 - 0.23) + 0 \cdot (0.45 - 0.34) + 174.4 \cdot (0.53 - 0.45)] + 428.1 \cdot \frac{(1 - 0.53)}{1}$$

$$e_{\text{UFCO2comp}} = 215.2 \text{ g/hp·hr}$$

(f) Calculate and evaluate cycle-validation criteria as specified in 40 CFR 1065.514 for nonhybrid engines and § 1036.545 for hybrid powertrains.

(g) Calculate the total emission mass of each constituent,  $m$ , over the test interval as described in 40 CFR 1065.650. Calculate the total work,  $W$ , over the test interval as described in 40 CFR 1065.650(d). For hybrid powertrains, calculate  $W$  using system power,  $P_{\text{sys}}$  as described in § 1036.520(f).

■ 26. Revise and republish § 1036.512 to read as follows:

**§ 1036.512 Federal Test Procedure.**

(a) Measure emissions using the transient Federal Test Procedure (FTP) as described in this section to determine whether engines meet the emission standards in subpart B of this part. Operate the engine or hybrid powertrain over one of the following transient duty cycles:

(1) For engines subject to spark-ignition standards, use the transient test interval described in paragraph (b) of appendix B to this part.

(2) For engines subject to compression-ignition standards, use the transient test interval described in paragraph (c) of appendix B to this part.

(b) Procedures apply differently for testing certain kinds of engines and powertrains as follows:

(1) The transient test intervals for nonhybrid engine testing are based on normalized speed and torque values. Denormalize speed as described in 40 CFR 1065.512. Denormalize torque as described in 40 CFR 1065.610(d).

(2) Test hybrid powertrains as described in § 1036.510(b)(2), with the following exceptions:

(i) Replace  $P_{\text{contrated}}$  with  $P_{\text{rated}}$ , which is the peak rated power determined in § 1036.520.

(ii) Keep the transmission in drive for all idle segments after the initial idle segment.

(iii) For hybrid engines, you may request to change the engine-commanded torque at idle to better represent curb idle transmission torque (CITT).

(iv) For plug-in hybrid powertrains, test over the FTP in both charge-sustaining and charge-depleting

operation for both criteria and greenhouse gas pollutant determination.

(c) Except as specified in paragraph (d) of this section for plug-in hybrid powertrains, the FTP duty cycle consists of an initial run through the test interval from a cold start as described in 40 CFR part 1065, subpart F, followed by a (20 ±1) minute hot soak with no engine operation, and then a final hot start run through the same transient test interval. Engine starting is part of both the cold-start and hot-start test intervals. Calculate the total emission mass of each constituent,  $m$ , over each test interval as described in 40 CFR 1065.650. Calculate the total work,  $W$ , over the test interval as described in 40 CFR 1065.650(d). For hybrid powertrains, calculate  $W$  using system power,  $P_{\text{sys}}$  as described in § 1036.520(f). Determine  $P_{\text{sys}}$  using § 1036.520(f). For powertrains with automatic transmissions, account for and include the work produced by the engine from the CITT load. Calculate the official transient emission result from the cold-start and hot-start test intervals using the following equation:

$$\text{Official transient emission result} = \frac{\text{cold start emissions (g)} + 6 \cdot \text{hot start emissions (g)}}{\text{cold start work (hp \cdot hr)} + 6 \cdot \text{hot start work (hp \cdot hr)}}$$

Eq. 1036.512-1

(d) Determine criteria pollutant emissions for plug-in hybrid powertrains as follows:

(1) Carry out a charge-sustaining test as described in paragraph (b)(2) of this section.

(2) Carry out a charge-depleting test as described in paragraph (b)(2) of this section, except as follows:

- (i) Fully charge the battery after preconditioning.
- (ii) Operate the engine or powertrain over one FTP duty cycle followed by alternating repeats of a 20-minute soak and a hot start test interval until you reach the end-of-test criteria defined in 40 CFR 1066.501(a)(3).
- (iii) Calculate emission results for each successive pair of test intervals.

Calculate the emission result by treating the first of the two test intervals as a cold-start test. Figure 1 to paragraph (d)(4) of this section provides an example of a charge-depleting test sequence where there are three test intervals with engine operation for two overlapping FTP duty cycles.

(3) Report the highest emission result for each criteria pollutant from all tests

in paragraphs (d)(1) and (2) of this section, even if those individual results come from different test intervals.

(4) The following figure illustrates an example of an FTP charge-depleting test sequence:

**Figure 1 to Paragraph (d)(4) of § 1036.512—FTP Charge-Depleting Criteria Pollutant Test Sequence**

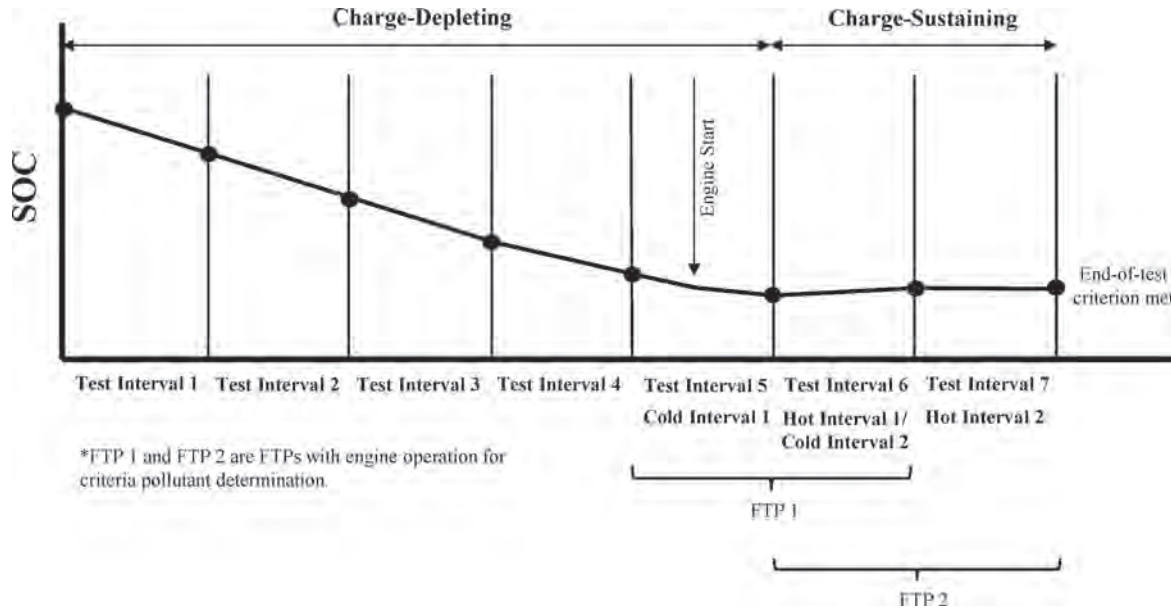

(e) Determine greenhouse gas pollutant emissions for plug-in hybrid engines and powertrains using the emissions results for all the transient duty cycle test intervals described in either paragraph (b) or (c) of appendix B to this part for both charge-depleting and charge-sustaining operation from paragraph (d)(2) of this section. Calculate the utility factor weighted composite mass of emissions from the charge-depleting and charge-sustaining test results,  $e_{UF[emission]comp}$ , as described in § 1036.510(e), replacing occurrences of “SET” with “transient test interval”. Note this results in composite FTP GHG emission results for plug-in hybrid engines and powertrains without the use of the cold-start and hot-start test interval weighting factors in Eq. 1036.512-1.

(f) Calculate and evaluate cycle-validation criteria as specified in 40 CFR 1065.514 for nonhybrid engines and § 1036.545 for hybrid powertrains.

■ 27. Revise § 1036.514 to read as follows:

**§ 1036.514 Low Load Cycle.**

Measure emissions using the transient Low Load Cycle (LLC) as described in this section to determine whether

engines meet the LLC emission standards in § 1036.104. The LLC duty cycle is described in paragraph (d) of appendix B to this part. Procedures apply differently for testing certain kinds of engines and powertrains as follows:

(a) Test nonhybrid engines using the following procedures:

(1) Use the normalized speed and torque values for engine testing in the LLC duty cycle. Denormalize speed and torque values as described in 40 CFR 1065.512 and 1065.610 with the following additional requirements for testing at idle:

(i) Apply the accessory load at idle in paragraph (c) of this section using declared idle power as described in 40 CFR 1065.510(f)(6). Declared idle torque must be zero.

(ii) Apply CITT in addition to accessory load as described in this paragraph (a)(1)(ii). Set reference speed and torque values as described in 40 CFR 1065.610(d)(3)(vi) for all idle segments that are 200 s or shorter to represent the transmission operating in drive. For longer idle segments, set the reference speed and torque values to the warm-idle-in-drive values for the first three seconds and the last three seconds

of the idle segment. For the points in between, set the reference speed and torque values to the warm-idle-in-neutral values to represent the transmission being manually shifted from drive to neutral shortly after the extended idle starts and back to drive shortly before it ends.

(2) Calculate and evaluate cycle-validation criteria as described in 40 CFR 1065.514, except as specified in paragraph (e) of this section.

(b) Test hybrid powertrains as described in § 1036.510(b)(2), with the following exceptions:

(1) Replace  $P_{contrated}$  with  $P_{rated}$ , which is the peak rated power determined in § 1036.520.

(2) Keep the transmission in drive for all idle segments 200 seconds or less. For idle segments more than 200 seconds, leave the transmission in drive for the first 3 seconds of the idle segment, then immediately place the transmission in park or neutral, and shift the transmission into drive again 3 seconds before the end of the idle segment. The end of the idle segment occurs at the first nonzero vehicle speed setpoint.

(3) For hybrid engines, you may request to change the GEM-generated

engine reference torque at idle to better represent curb idle transmission torque (CITT).

(4) Adjust procedures in this section as described in § 1036.510(d) and (e) for plug-in hybrid powertrains to determine criteria pollutant and greenhouse gas emissions, replacing “SET” with “LLC”. Note that the LLC is therefore the preconditioning duty cycle for plug-in hybrid powertrains.

(5) Calculate and evaluate cycle-validation criteria as specified in § 1036.545.

(c) Include vehicle accessory loading as follows:

(1) Apply a vehicle accessory load for each idle point in the cycle using the power values in the following table:

TABLE 1 TO PARAGRAPH (c)(1) OF § 1036.514—ACCESSORY LOAD AT IDLE

Primary intended service class	Power representing accessory load (kW)
Light HDE .....	1.5
Medium HDE .....	2.5
Heavy HDE .....	3.5

(2) For nonhybrid engine testing, apply vehicle accessory loads in addition to any applicable CITT.

(3) Additional provisions related to vehicle accessory load apply for engines with stop-start technology and hybrid powertrains where the accessory load is applied to the engine shaft. Account for the loss of mechanical work due to the lack of any idle accessory load during engine-off conditions by determining the total loss of mechanical work from idle accessory load during all engine-off intervals over the entire test interval and distributing that work over the engine-portion of the entire test interval based on a calculated average power. You may determine the engine-off time by running practice cycles or through engineering analysis.

(d) Except as specified in paragraph (b)(4) of this section for plug-in hybrid powertrains, the test sequence consists of preconditioning the engine by running one or two FTPs with each FTP followed by (20 ± 1) minutes with no engine operation and a hot start run through the LLC. You may start any preconditioning FTP with a hot engine. Perform testing as described in 40 CFR

1065.530 for a test interval that includes engine starting. Calculate the total emission mass of each constituent, *m*, over the test interval as described in 40 CFR 1065.650. For nonhybrid engines, calculate the total work, *W*, over the test interval as described in 40 CFR 1065.650(d). For hybrid powertrains, calculate total positive work over the test interval using system power, *P<sub>sys</sub>*. Determine *P<sub>sys</sub>* using § 1036.520(f). For powertrains with automatic transmissions, account for and include the work produced by the engine from the CITT load.

(e) For testing spark-ignition gaseous-fueled engines with fuel delivery at a single point in the intake manifold, you may apply the alternative cycle-validation criteria for the LLC in the following table:

TABLE 2 TO PARAGRAPH (e) OF § 1036.514—ALTERNATIVE LLC CYCLE VALIDATION CRITERIA FOR SPARK-IGNITION GASEOUS-FUELED ENGINES<sup>a</sup>

Parameter	Speed	Torque	Power
Slope, <i>a</i> <sub>1</sub> .....	.....	0.800 ≤ <i>a</i> <sub>1</sub> ≤ 1.030 .....	0.800 ≤ <i>a</i> <sub>1</sub> ≤ 1.030.
Absolute value of intercept,   <i>a</i> <sub>0</sub>   .....	.....	.....	≤15% of maximum mapped power.
Standard error of the estimate, <i>SEE</i> .....	.....	.....	≥0.650.
Coefficient of determination, <i>r</i> <sup>2</sup> .....	.....	≥0.650 .....	.....

<sup>a</sup> Cycle-validation criteria apply as specified in 40 CFR 1065.514 unless otherwise specified.

■ 28. Amend § 1036.520 by revising the introductory text and paragraphs (b) introductory text, (d), and (h) through (j) to read as follows:

**§ 1036.520 Determining power and vehicle speed values for powertrain testing.**

This section describes how to determine the system peak power and continuous rated power of hybrid and nonhybrid powertrain systems and the vehicle speed for carrying out duty-cycle testing under this part and § 1036.545.

\* \* \* \* \*

(b) Set up the powertrain test according to § 1036.545, with the following exceptions:

\* \* \* \* \*

(d) Carry out the test as described in this paragraph (d). Warm up the powertrain by operating it. We recommend operating the powertrain at any vehicle speed and road grade that

achieves approximately 75% of its expected maximum power. Continue the warm-up until the engine coolant, block, lubricating oil, or head absolute temperature is within ±2% of its mean value for at least 2 min or until the engine thermostat controls engine temperature. Within 90 seconds after concluding the warm-up, operate the powertrain over a continuous trace meeting the following specifications:

(1) Bring the vehicle speed to 0 mi/hr and let the powertrain idle at 0 mi/hr for 50 seconds.

(2) Set maximum driver demand for a full load acceleration at 6.0% road grade with an initial vehicle speed of 0 mi/hr, continuing for 268 seconds. You may increase initial vehicle speed up to 5 mi/hr to minimize clutch slip.

(3) Linearly ramp the grade from 6.0% down to 0.0% over 300 seconds. Stop

the test after the acceleration is less than 0.02 m/s<sup>2</sup>.

\* \* \* \* \*

(h) Determine rated power, *P<sub>rated</sub>*, as the maximum measured power from the data collected in paragraph (d)(2) of this section where the COV determined in paragraph (g) of this section is less than 2%.

(i) Determine continuous rated power, *P<sub>contrated</sub>*, as follows:

(1) For nonhybrid powertrains,

*P<sub>contrated</sub>* equals *P<sub>rated</sub>*.

(2) For hybrid powertrains, *P<sub>contrated</sub>* is the maximum measured power from the data collected in paragraph (d)(3) of this section where the COV determined in paragraph (g) of this section is less than 2%.

(j) Determine vehicle C speed, *v<sub>refC</sub>*, as follows:

(1) If the maximum *P<sub>sys</sub>(t)* in the highest gear during the maneuver in paragraph (d)(3) of this section is greater

than  $0.98 \cdot P_{\text{contrated}}$ ,  $v_{\text{refC}}$  is the average of the minimum and maximum vehicle speeds where  $P_{\text{sys}}(t)$  is equal to  $0.98 \cdot P_{\text{contrated}}$  during the maneuver in paragraph (d)(3) where the transmission is in the highest gear, using linear interpolation, as appropriate. If  $P_{\text{sys}}(t)$  at the lowest vehicle speed where the transmission is in the highest gear is greater than  $0.98 \cdot P_{\text{contrated}}$ , use the lowest vehicle speed where the transmission is in the highest gear as the minimum vehicle speed input for calculating  $v_{\text{refC}}$ .

(2) Otherwise,  $v_{\text{refC}}$  is the maximum vehicle speed during the maneuver in paragraph (d)(3) of this section where the transmission is in the highest gear.

(3) You may use a declared  $v_{\text{refC}}$  instead of measured  $v_{\text{refC}}$  if the declared  $v_{\text{refC}}$  is within (97.5 to 102.5)% of the corresponding measured value.

(4) Manufacturers may request approval to use an alternative vehicle C speed in place of the measured vehicle C speed determined in this paragraph (j) for series hybrid applications. Approval will be contingent upon justification that the measured vehicle C speed is not representative of the expected real-world cruise speed.

■ 29. Amend § 1036.525 by revising the introductory text to read as follows:

**§ 1036.525 Clean Idle test.**

Measure emissions using the procedures described in this section to determine whether engines and hybrid powertrains meet the clean idle emission standards in § 1036.104(b). For

plug-in hybrid powertrains, perform the test with the hybrid function disabled.

■ 30. Amend § 1036.530 by revising paragraphs (g)(1) and (g)(2)(ii) and adding paragraph (j) to read as follows:

**§ 1036.530 Test procedures for off-cycle testing.**

(1) *Spark-ignition*. For engines subject to spark-ignition standards, the off-cycle emission quantity,  $e_{[\text{emission}],\text{offcycle}}$ , is the value for CO<sub>2</sub>-specific emission mass for a given pollutant over the test interval representing the shift-day converted to a brake-specific value, as calculated for each measured pollutant using the following equation:

$$e_{[\text{emissions}],\text{offcycle}} = \frac{m_{[\text{emission}]}}{m_{\text{CO}_2}} \cdot e_{\text{CO}_2,\text{FTP,FCL}}$$

Eq. 1036.530-3

Where:

$m_{[\text{emission}]}$  = total emission mass for a given pollutant over the test interval as

determined in paragraph (d)(2) of this section.

$m_{\text{CO}_2}$  = total CO<sub>2</sub> emission mass over the test interval as determined in paragraph (d)(2) of this section.

$e_{\text{CO}_2,\text{FTP,FCL}}$  = the engine's FCL for CO<sub>2</sub> over the FTP duty cycle.

Example:

$$\begin{aligned} m_{\text{NO}_x} &= 1.337 \text{ g} \\ m_{\text{CO}_2} &= 18778 \text{ g} \\ e_{\text{CO}_2,\text{FTP,FCL}} &= 505.1 \text{ g/hp}\cdot\text{hr} \\ e_{\text{NO}_x,\text{offcycle}} &= \frac{1.337}{18778} \cdot 505.1 \\ e_{\text{NO}_x,\text{offcycle}} &= 0.035 \text{ g/hp}\cdot\text{hr} = 35 \text{ mg/hp}\cdot\text{hr} \end{aligned}$$

(2) \* \* \*  
 (ii) *Off-cycle emissions quantity for bin 2*. The off-cycle emission quantity for bin 2,  $e_{[\text{emission}],\text{offcycle},\text{bin}2}$ , is the value

for CO<sub>2</sub>-specific emission mass for a given pollutant of all the 300 second test intervals in bin 2 combined and

converted to a brake-specific value, as calculated for each measured pollutant using the following equation:

$$e_{[\text{emissions}],\text{offcycle},\text{bin}2} = \frac{\sum_{i=1}^N m_{[\text{emission}],\text{testinterval},i}}{\sum_{i=1}^N m_{\text{CO}_2,\text{testinterval},i}} \cdot e_{\text{CO}_2,\text{FTP,FCL}}$$

Eq. 1036.530-5

Where:

$i$  = an indexing variable that represents one 300 second test interval.  
 $N$  = total number of 300 second test intervals in bin 2.  
 $m_{[\text{emission}],\text{testinterval},i}$  = total emission mass for a given pollutant over the test interval  $i$

in bin 2 as determined in paragraph (d)(2) of this section.

$m_{\text{CO}_2,\text{testinterval},i}$  = total CO<sub>2</sub> emission mass over the test interval  $i$  in bin 2 as determined in paragraph (d)(2) of this section.  
 $e_{\text{CO}_2,\text{FTP,FCL}}$  = the engine's FCL for CO<sub>2</sub> over the FTP duty cycle.

Example:

$$\begin{aligned} N &= 15439 \\ m_{\text{NO}_x1} &= 0.546 \text{ g} \\ m_{\text{NO}_x2} &= 0.549 \text{ g} \\ m_{\text{NO}_x3} &= 0.556 \text{ g} \\ m_{\text{CO}_2,1} &= 10950.2 \text{ g} \\ m_{\text{CO}_2,2} &= 10961.3 \text{ g} \\ m_{\text{CO}_2,3} &= 10965.3 \text{ g} \\ e_{\text{CO}_2,\text{FTP,FCL}} &= 428.1 \text{ g/hp}\cdot\text{hr} \end{aligned}$$

$$\begin{aligned} e_{\text{NO}_x,\text{offcycle},\text{bin}2} &= \frac{(0.546 + 0.549 + 0.556 \dots + m_{\text{NO}_x,\text{testinterval},15439})}{(10950.2 + 10961.3 + 10965.3 \dots + m_{\text{CO}_2,\text{testinterval},15439})} \cdot 428.1 \\ e_{\text{NO}_x,\text{offcycle},\text{bin}2} &= 0.026 \text{ g/hp}\cdot\text{hr} = 26 \text{ mg/hp}\cdot\text{hr} \end{aligned}$$



\* \* \* \* \*  
 (j) *Fuel other than carbon-containing.*  
 The following procedures apply for

testing engines using at least one fuel that is not a carbon-containing fuel:  
 (1) Use the following equation to determine the normalized equivalent

CO<sub>2</sub> emission mass over each 300 second test interval instead of Eq. 1036.530–2:

$$m_{\text{CO}_2, \text{norm, equiv, testinterval}} = \frac{W_{\text{testinterval}}}{P_{\text{max}} \cdot t_{\text{testinterval}}}$$

Eq. 1036.530–6

Where:

$W_{\text{testinterval}}$  = total positive work over the test interval from both the engine and hybrid components, if applicable, as determined in 40 CFR 1065.650.

$P_{\text{max}}$  = the highest value of rated power for all the configurations included in the engine family.  
 $t_{\text{testinterval}}$  = duration of the test interval. Note that the nominal value is 300 seconds.

$W_{\text{testinterval}} = 8.95 \text{ hp}\cdot\text{hr}$   
 $P_{\text{max}} = 406.5 \text{ hp}$   
 $t_{\text{testinterval}} = 300.01 \text{ s} = 0.08 \text{ hr}$

Example:

$$m_{\text{CO}_2, \text{norm, testinterval}} = \frac{8.95}{406.5 \cdot 0.08}$$

$$m_{\text{CO}_2, \text{norm, testinterval}} = 0.2722$$

$$m_{\text{CO}_2, \text{norm, testinterval}} = 27.22 \%$$

(2) Determine off-cycle emissions quantities as follows:

(i) For engines subject to spark-ignition standards, use the following equation to determine the off-cycle

emission quantity instead of Eq. 1036.530–3:

$$e_{[\text{emissions}], \text{offcycle}} = \frac{m_{[\text{emission}]}}{W_{\text{testinterval}}}$$

Eq. 1036.530–7

Where:

$m_{[\text{emission}]}$  = total emission mass for a given pollutant over the test interval as determined in paragraph (d)(2) of this section.

$W_{\text{testinterval}}$  = total positive work over the test interval as determined in 40 CFR 1065.650.

Example:

$$m_{\text{NO}_x} = 1.337 \text{ g}$$

$$W_{\text{testinterval}} = 38.2 \text{ hp}\cdot\text{hr}$$

$$e_{\text{NO}_x, \text{offcycle}} = \frac{1.337}{38.2}$$

$$e_{\text{NO}_x, \text{offcycle}} = 0.035 \text{ g}/\text{hp}\cdot\text{hr} = 35 \text{ mg}/\text{hp}\cdot\text{hr}$$

(ii) For engines subject to compression-ignition standards, use Eq.

1036.530–4 to determine the off-cycle emission quantity for bin 1.

following equation to determine the off-cycle emission quantity for bin 2 instead of Eq. 1036.530–5:

(iii) For engines subject to compression-ignition standards, use the

$$e_{[\text{emissions}], \text{offcycle, bin2}} = \frac{\sum_{i=1}^N m_{[\text{emission}], \text{testinterval}, i}}{\sum_{i=1}^N W_{\text{testinterval}, i}}$$

Eq. 1036.530–8

Where:

$i$  = an indexing variable that represents one 300 second test interval.  
 $N$  = total number of 300 second test intervals in bin 2.

$m_{[\text{emission}], \text{testinterval}, i}$  = total emission mass for a given pollutant over the test interval  $i$  in bin 2 as determined in paragraph (d)(2) of this section.

$W_{\text{testinterval}, i}$  = total positive work over the test interval  $i$  in bin 2 as determined in 40 CFR 1065.650.

$N = 15439$   
 $m_{\text{NO}_x1} = 0.546 \text{ g}$   
 $m_{\text{NO}_x2} = 0.549 \text{ g}$   
 $m_{\text{NO}_x3} = 0.556 \text{ g}$   
 $W_{\text{testinterval}1} = 8.91 \text{ hp}\cdot\text{hr}$   
 $W_{\text{testinterval}2} = 8.94 \text{ hp}\cdot\text{hr}$   
 $W_{\text{testinterval}3} = 8.89 \text{ hp}\cdot\text{hr}$

Example:

$$e_{\text{NOx,offcycle,bin2}} = \frac{(0.546 + 0.549 + 0.556 \dots + m_{\text{NOx,testinterval,15439}})}{(8.91 + 8.94 + 8.89 \dots + W_{\text{testinterval,15439}})}$$

$$e_{\text{NOx,offcycle,bin2}} = 0.026 \text{ g/hp}\cdot\text{hr} = 26 \text{ mg/hp}\cdot\text{hr}$$

■ 31. Amend § 1036.535 by revising paragraphs (b)(1)(ii) and (iii), (b)(8) and (10), and (e) to read as follows:

**§ 1036.535 Determining steady-state engine fuel maps and fuel consumption at idle.**

\* \* \* \* \*  
 (b) \* \* \*  
 (1) \* \* \*

(ii) Select the following required torque setpoints at each of the selected speed setpoints: zero ( $T = 0$ ), maximum mapped torque,  $T_{\text{max mapped}}$ , and eight (or more) equally spaced points between  $T = 0$  and  $T_{\text{max mapped}}$ . Select the maximum torque setpoint at each speed to conform to the torque map as follows:

(A) Calculate 5 percent of  $T_{\text{max mapped}}$ . Subtract this result from the mapped torque at each speed setpoint,  $T_{\text{max}}$ .

(B) Select  $T_{\text{max}}$  at each speed setpoint as a single torque value to represent all

the required torque setpoints above the value determined in paragraph (b)(1)(ii)(A) of this section. All the other default torque setpoints less than  $T_{\text{max}}$  at a given speed setpoint are required torque setpoints.

(iii) You may select any additional speed and torque setpoints consistent with good engineering judgment. For example, you may need to select additional points if the engine's fuel consumption is nonlinear across the torque map. Avoid creating a problem with interpolation between narrowly spaced speed and torque setpoints near  $T_{\text{max}}$ . For each additional speed setpoint, we recommend including a torque setpoint of  $T_{\text{max}}$ ; however, you may select torque setpoints that properly represent in-use operation. Increments for torque setpoints between these minimum and maximum values at an

additional speed setpoint must be no more than one-ninth of  $T_{\text{max,mapped}}$ . Note that if the test points were added for the child rating, they should still be reported in the parent fuel map. We will test with at least as many points as you. If you add test points to meet testing requirements for child ratings, include those same test points as reported values for the parent fuel map. For our testing, we will use the same normalized speed and torque test points you use, and we may select additional test points.

\* \* \* \* \*

(8) If you determine fuel-consumption rates using emission measurements from the raw or diluted exhaust, calculate the mean fuel mass flow rate,  $\bar{m}_{\text{fuel}}$ , for each point in the fuel map using the following equation:

$$\bar{m}_{\text{fuel}} = \frac{M_C}{W_{\text{Cmeas}}} \cdot \left( \bar{n} \cdot \frac{\bar{x}_{\text{Ccombdry}}}{1 + \bar{x}_{\text{H2Oexhdry}}} - \frac{\bar{m}_{\text{CO2DEF}}}{M_{\text{CO2}}} \right)$$

Eq. 1036.535-1

Where:

$\bar{m}$  = mean fuel mass flow rate for a given fuel map setpoint, expressed to at least the nearest 0.001 g/s.

$M_C$  = molar mass of carbon.

$W_{\text{Cmeas}}$  = carbon mass fraction of fuel (or mixture of test fuels) as determined in 40 CFR 1065.655(d), except that you may not use the default properties in 40 CFR 1065.655(e)(5) to determine  $\alpha$ ,  $\beta$ , and  $w_C$ . You may not account for the contribution to  $\alpha$ ,  $\beta$ ,  $\gamma$ , and  $\delta$  of diesel exhaust fluid or other non-fuel fluids injected into the exhaust.

$\bar{n}$  = the mean exhaust molar flow rate from which you measured emissions according to 40 CFR 1065.655.

$\bar{x}_{\text{Ccombdry}}$  = the mean concentration of carbon from fuel and any injected fluids in the exhaust per mole of dry exhaust as determined in 40 CFR 1065.655(c).

$\bar{x}_{\text{H2Oexhdry}}$  = the mean concentration of H<sub>2</sub>O in exhaust per mole of dry exhaust as determined in 40 CFR 1065.655(c).

$\bar{m}_{\text{CO2DEF}}$  = the mean CO<sub>2</sub> mass emission rate resulting from diesel exhaust fluid decomposition as determined in paragraph (b)(9) of this section. If your engine does not

use diesel exhaust fluid, or if you choose not to perform this correction, set equal to 0.

$M_{\text{CO2}}$  = molar mass of carbon dioxide.

Example:

$M_C = 12.0107 \text{ g/mol}$

$W_{\text{Cmeas}} = 0.869$

$\bar{n} = 25.534 \text{ mol/s}$

$\bar{x}_{\text{Ccombdry}} = 0.002805 \text{ mol/mol}$

$\bar{x}_{\text{H2Oexhdry}} = 0.0353 \text{ mol/mol}$

$\bar{m}_{\text{CO2DEF}} = 0.0726 \text{ g/s}$

$M_{\text{CO2}} = 44.0095 \text{ g/mol}$

$$\bar{m}_{\text{fuel}} = \frac{12.0107}{0.869} \cdot \left( 25.534 \cdot \frac{0.002805}{1 + 0.0353} - \frac{0.0726}{44.0095} \right)$$

$$\bar{m}_{\text{fuel}} = 0.933 \text{ g/s}$$

\* \* \* \* \*

(10) Correct the measured or calculated mean fuel mass flow rate, at each of the operating points to account for mass-specific net energy content as described in paragraph (e) of this section.

\* \* \* \* \*

(e) *Correction for net energy content.* Correct the measured or calculated mean fuel mass flow rate,  $\bar{m}_{\text{fuel}}$ , for each test interval to a mass-specific net

energy content of a reference fuel using the following equation:

$$\bar{m}_{\text{fuelcor}} = \bar{m}_{\text{fuel}} \cdot \frac{E_{\text{mfuelmeas}}}{E_{\text{mfuelCref}} \cdot W_{\text{Cref}}}$$

Eq. 1036.535-4

Where:

$E_{\text{mfuelmeas}}$  = the mass-specific net energy content of the test fuel as determined in § 1036.550(b)(1). Note that dividing this value by  $w_{\text{Cref}}$  (as is done in this equation)

equates to a carbon-specific net energy content having the same units as  $E_{\text{mfuelCref}}$ .

$E_{\text{mfuelCref}}$  = the reference value of carbon-mass-specific net energy content for the appropriate fuel. Use the values shown in table 1 to paragraph (b)(4) of § 1036.550 for the designated fuel types, or values we approve for other fuel types.

$W_{\text{Cref}}$  = the reference value of carbon mass fraction for the test fuel as shown in table 1 to paragraph (b)(4) of § 1036.550 for the designated fuels. For any fuel not identified in the table, use the reference carbon mass

fraction of diesel fuel for engines subject to compression-ignition standards, and use the reference carbon mass fraction of gasoline for engines subject to spark-ignition standards.

Example:

$$= 0.933 \text{ g/s}$$

$$\dot{m}_{\text{fuel}} = 0.933 \text{ g/s}$$

$$E_{\text{mfuel/meas}} = 42.7984 \text{ MJ/kg}$$

$$E_{\text{mfuel/Cref}} = 49.3112 \text{ MJ/kgC}$$

$$W_{\text{Cref}} = 0.874 \text{ kgC/kg}$$

$$\dot{m}_{\text{fuel}} = 0.933 \cdot \frac{42.7984}{49.3112 \cdot 0.874}$$

$$\dot{m}_{\text{fuel}} = 0.927 \text{ g/s}$$

\* \* \* \* \*

■ 32. Amend § 1036.540 by revising paragraph (b), table 1 to paragraph (c)(2), and paragraphs (d) introductory

text, (d)(3), and (d)(12)(i)(A) to read as follows:

**§ 1036.540 Determining cycle-average engine fuel maps.**

\* \* \* \* \*

(b) *General test provisions.* The following provisions apply for testing under this section:

(1) Measure NO<sub>x</sub> emissions for each specified sampling period in grams. You may perform these measurements using a NO<sub>x</sub> emission-measurement system that meets the requirements of 40 CFR part 1065, subpart J. Include these measured NO<sub>x</sub> values any time you report to us your fuel-consumption values from testing under this section. If a system malfunction prevents you from measuring NO<sub>x</sub> emissions during a test under this section but the test otherwise gives valid results, you may consider

this a valid test and omit the NO<sub>x</sub> emission measurements; however, we may require you to repeat the test if we determine that you inappropriately voided the test with respect to NO<sub>x</sub> emission measurement.

(2) The provisions related to carbon balance error verification in § 1036.543 apply for all testing in this section.

These procedures are optional, but we will perform carbon balance error verification for all testing under this section.

(3) Correct fuel mass to a mass-specific net energy content of a reference fuel as described in paragraph (d)(13) of this section.

(4) This section uses engine parameters and variables that are consistent with 40 CFR part 1065.

(c) \* \* \*

(2) \* \* \*

TABLE 1 TO PARAGRAPH (c)(2) OF § 1036.540—GEM INPUT FOR GEAR RATIO

Gear No.	Spark-ignition HDE, light HDE, and medium HDE— all duty cycles	Heavy HDE— transient and ftp duty cycles	Heavy HDE— cruise and set duty cycles
1	3.10	3.51	12.8
2	1.81	1.91	9.25
3	1.41	1.43	6.76
4	1.00	1.00	4.90
5	0.71	0.74	3.58
6	0.61	0.64	2.61
7	—	—	1.89
8	—	—	1.38
9	—	—	1.00
10	—	—	0.73
Lockup Gear	3	3	—

\* \* \* \* \*

(d) *Test the engine with GEM cycles.* Test the engine over each of the engine duty cycles generated in paragraph (c) of this section as follows:

\* \* \* \* \*

(3) Control speed and torque to meet the cycle validation criteria in 40 CFR

1065.514 for each interval, except that the standard error of the estimate in 40 CFR 1065.514(f)(3) is the only speed criterion that applies if the range of reference speeds is less than 10 percent of the mean reference speed. For spark-ignition gaseous-fueled engines with fuel delivery at a single point in the

intake manifold, you may apply the alternative cycle-validation criteria in table 5 to this paragraph (c)(3) for transient testing. Note that 40 CFR part 1065 does not allow reducing cycle precision to a lower frequency than the 10 Hz reference cycle generated by GEM.

TABLE 5 TO PARAGRAPH (c)(3) OF § 1036.540— ALTERNATIVE FUEL-MAPPING CYCLE-VALIDATION CRITERIA FOR SPARK-IGNITION GASEOUS-FUELED ENGINES <sup>A</sup>

Parameter	Speed	Torque	Power
Slope, $a_1$			
Absolute value of intercept, $ a_0 $ ....		≤3% of maximum mapped torque	
Standard error of the estimate, SEE.		≤15% of maximum mapped torque.	≤15% of maximum mapped power.
Coefficient of determination, $r^2$ .....		≥0.700	≥0.750.

<sup>A</sup> Cycle-validation criteria apply as specified in 40 CFR 1065.514 unless otherwise specified.

\* \* \* \* \*

(12) \* \* \*

(i) \* \* \*

(A) For calculations that use continuous measurement of emissions

and continuous CO<sub>2</sub> from urea, calculate  $m_{\text{fuel[cycle]}}$  using the following equation:

$$m_{\text{fuel}[\text{cycle}]} = \frac{M_C}{w_{C\text{meas}}} \cdot \left( \sum_{i=1}^N \left( \dot{n}_i \cdot \frac{x_{C\text{comb}dryi}}{1 + x_{H_2O\text{ex}dryi}} \cdot \Delta t \right) - \frac{1}{M_{CO_2}} \sum_{i=1}^N (\dot{m}_{CO_2DEFi} \cdot \Delta t) \right)$$

Eq. 1036.540–3

Where:

$M_C$  = molar mass of carbon.

$w_{C\text{meas}}$  = carbon mass fraction of fuel (or mixture of fuels) as determined in 40 CFR 1065.655(d), except that you may not use the default properties in 40 CFR 1065.655(e)(5) to determine  $\alpha$ ,  $\beta$ , and  $w_C$ . You may not account for the contribution to  $\alpha$ ,  $\beta$ ,  $\gamma$ , and  $\delta$  of diesel exhaust fluid or other non-fuel fluids injected into the exhaust.

$i$  = an indexing variable that represents one recorded emission value.

$N$  = total number of measurements over the duty cycle.

$\dot{n}_i$  = exhaust molar flow rate from which you measured emissions according to 40 CFR 1065.655.

$x_{C\text{comb}dryi}$  = amount of carbon from fuel and any injected fluids in the exhaust per mole of dry exhaust as determined in 40 CFR 1065.655(c).

$x_{H_2O\text{ex}dryi}$  = amount of H<sub>2</sub>O in exhaust per mole of exhaust as determined in 40 CFR 1065.655(c).

$\Delta t = 1/f_{\text{record}}$

$M_{CO_2}$  = molar mass of carbon dioxide.

$\dot{m}_{CO_2DEFi}$  = mass emission rate of CO<sub>2</sub> resulting from diesel exhaust fluid decomposition over the duty cycle as determined from § 1036.535(b)(9). If your engine does not utilize diesel exhaust fluid for emission control, or if you choose not to perform this correction, set  $\dot{m}_{CO_2DEFi}$  equal to 0.

Example:

$M_C = 12.0107 \text{ g/mol}$

$w_{C\text{meas}} = 0.867$

$N = 6680$

$\dot{n}_1 = 2.876 \text{ mol/s}$

$\dot{n}_2 = 2.224 \text{ mol/s}$

$x_{C\text{comb}dry1} = 2.61 \cdot 10^{-3} \text{ mol/mol}$

$x_{C\text{comb}dry2} = 1.91 \cdot 10^{-3} \text{ mol/mol}$

$x_{H_2O\text{ex}h1} = 3.53 \cdot 10^{-2} \text{ mol/mol}$

$x_{H_2O\text{ex}h2} = 3.13 \cdot 10^{-2} \text{ mol/mol}$

$f_{\text{record}} = 10 \text{ Hz}$

$\Delta t = 1/10 = 0.1 \text{ s}$

$M_{CO_2} = 44.0095 \text{ g/mol}$

$\dot{m}_{CO_2DEF1} = 0.0726 \text{ g/s}$

$\dot{m}_{CO_2DEF2} = 0.0751 \text{ g/s}$

$$\frac{12.0107}{0.867} \cdot \left( \left( \begin{array}{l} 2.876 \cdot \frac{2.61 \cdot 10^{-3}}{1 + 3.53 \cdot 10^{-2}} \cdot 0.1 + \\ 2.224 \cdot \frac{1.91 \cdot 10^{-3}}{1 + 3.13 \cdot 10^{-2}} \cdot 0.1 + \\ \dots + \dot{n}_{6680} \cdot \frac{x_{C\text{comb}dry6680}}{1 + x_{H_2O\text{ex}dry6680}} \cdot \Delta t_{6680} \\ - \frac{1}{44.0095} \cdot (0.0726 \cdot 1.0 + 0.0751 \cdot 1.0 + \dots + \dot{m}_{CO_2DEF6680} \cdot \Delta t_{6680}) \end{array} \right) \right)$$

$m_{\text{fuel}[\text{transientTest}]} = 1619.6 \text{ g}$

\* \* \* \* \*

■ 33. Revise § 1036.543 to read as follows:

**§ 1036.543 Carbon balance error verification.**

The optional carbon balance error verification in 40 CFR 1065.543 compares independent assessments of the flow of carbon through the system (engine plus aftertreatment). This procedure applies for each individual interval in §§ 1036.535(b), (c), and (d), 1036.540, and 1036.545.

■ 34. Add § 1036.545 to read as follows:

**§ 1036.545 Powertrain testing.**

This section describes the procedure to measure fuel consumption and create engine fuel maps by testing a powertrain that includes an engine coupled with a transmission, drive axle, and hybrid components or any assembly with one or more of those hardware elements. Engine fuel maps are part of demonstrating compliance with Phase 2 and Phase 3 vehicle standards under 40 CFR part 1037; the powertrain test

procedure in this section is one option for generating this fuel-mapping information as described in § 1036.505. Additionally, this powertrain test procedure is one option for certifying hybrid powertrains to the engine standards in §§ 1036.104 and 1036.108.

(a) *General test provisions.* The following provisions apply broadly for testing under this section:

(1) Measure NO<sub>x</sub> emissions as described in paragraph (k) of this section. Include these measured NO<sub>x</sub> values any time you report to us your greenhouse gas emissions or fuel consumption values from testing under this section.

(2) The procedures of 40 CFR part 1065 apply for testing in this section except as specified. This section uses engine parameters and variables that are consistent with 40 CFR part 1065.

(3) Powertrain testing depends on models to calculate certain parameters. You can use the detailed equations in this section to create your own models, or use the GEM HIL model contained within GEM Phase 2, Version 4.0

(incorporated by reference, see § 1036.810) to simulate vehicle hardware elements as follows:

(i) Create driveline and vehicle models that calculate the angular speed setpoint for the test cell dynamometer,  $f_{\text{nref,dyno}}$ , based on the torque measurement location. Use the detailed equations in paragraph (f) of this section, the GEM HIL model's driveline and vehicle submodels, or a combination of the equations and the submodels. You may use the GEM HIL model's transmission submodel in paragraph (f) to simulate a transmission only if testing hybrid engines. If the engine is intended for vehicles with automatic transmissions, use the cycle configuration file in GEM to change the transmission state (in-gear or idle) as a function of time as defined by the duty cycles in this part.

(ii) Create a driver model or use the GEM HIL model's driver submodel to simulate a human driver modulating the throttle and brake pedals to follow the test cycle as closely as possible.

(iii) Create a cycle-interpolation model or use the GEM HIL model's cycle submodel to interpolate the duty-cycles and feed the driver model the duty-cycle reference vehicle speed for each point in the duty-cycle.

(4) The powertrain test procedure in this section is designed to simulate operation of different vehicle configurations over specific duty cycles. See paragraphs (h) and (j) of this section.

(5) For each test run, record engine speed and torque as defined in 40 CFR 1065.915(d)(5) with a minimum sampling frequency of 1 Hz. These engine speed and torque values represent a duty cycle that can be used for separate testing with an engine mounted on an engine dynamometer under 40 CFR 1037.551, such as for a selective enforcement audit as described in 40 CFR 1037.301.

(6) For hybrid powertrains with no plug-in capability, correct for the net energy change of the energy storage device as described in 40 CFR 1066.501(a)(3). For plug-in hybrid electric powertrains, follow 40 CFR 1066.501(a)(3) to determine End-of-Test for charge-depleting operation. You must get our approval in advance for your utility factor curve; we will

approve it if you can show that you created it, using good engineering judgment, from sufficient in-use data of vehicles in the same application as the vehicles in which the plug-in hybrid electric powertrain will be installed. You may use methodologies described in SAE J2841 to develop the utility factor curve.

(7) The provisions related to carbon balance error verification in § 1036.543 apply for all testing in this section. These procedures are optional if you are only performing direct or indirect fuel-flow measurement, but we will perform carbon balance error verification for all testing under this section.

(8) Do not apply accessory loads when conducting a powertrain test to generate inputs to GEM if torque is measured at the axle input shaft or wheel hubs.

(9) If you test a powertrain over the Low Load Cycle specified in § 1036.514, control and apply the electrical accessory loads. We recommend using a load bank connected directly to the powertrain's electrical system. You may instead use an alternator with dynamic electrical load control. Use good engineering judgment to account for the efficiency of the alternator or the efficiency of the powertrain to convert

the mechanical energy to electrical energy.

(10) The following instruments are required with plug-in hybrid systems to determine required voltages and currents during testing and must be installed on the powertrain to measure these values during testing:

(i) Measure the voltage and current of the battery pack directly with a DC wideband power analyzer to determine power. Measure all current entering and leaving the battery pack. Do not measure voltage upstream of this measurement point. The maximum integration period for determining amp-hours is 0.05 seconds. The power analyzer must have an accuracy for measuring current and voltage of 1% of point or 0.3% of maximum, whichever is greater. The power analyzer must not be susceptible to offset errors while measuring current.

(ii) If safety considerations do not allow for measuring voltage, you may determine the voltage directly from the powertrain ECM.

(11) The following figure provides an overview of testing under this section:

**BILLING CODE 6560-50-P**

**Figure 1 to Paragraph (a)(11) of § 1036.545—Overview of Powertrain Testing.**

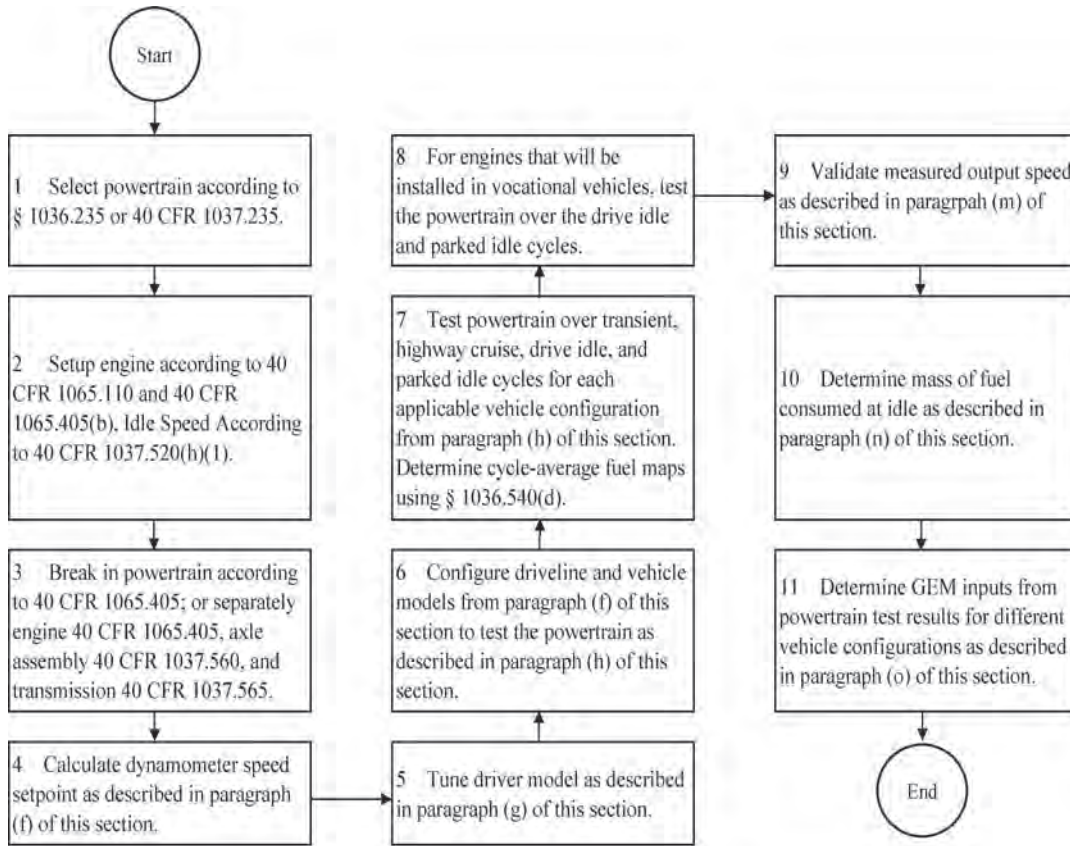

Duty Cycle Exceptions

SET, FTP, LLC

SET Specific

FTP Specific

LLC Specific

Note

- 1) Do not compensate the duty cycle for the distance driven in step 5.
- 2) Disregard duty cycles in step 7.
- 3) For cycles that begin with idle, leave the transmission in neutral or park for the full initial idle segment. Place the transmission into drive no earlier than 5 seconds before the first nonzero vehicle speed setpoint.
- 4) Use the vehicle parameters in § 1036.505(b)(2)(i) to (viii) to define the vehicle model in § 1036.545(a)(3).

- 1) For SET testing only, place the transmission into park or neutral when the cycle reaches the final idle segment.
- 2) Select the transmission from Table 1 of § 1036.540.

- 1) Replace  $P_{\text{control}}$  with  $P_{\text{rated}}$  which is the peak rated power determined in § 1036.520.
- 2) Keep the transmission in drive for all idle segments after the initial idle segment.
- 3) For hybrid engines, select the transmission from Table 1 of § 1036.540.
- 4) For hybrid engines, you may request to change the engine-commanded torque at idle to better represent curb idle transmission torque (CITT).

- 1) Replace  $P_{\text{control}}$  with  $P_{\text{rated}}$  which is the peak rated power determined in § 1036.520.
- 2) Keep the transmission in drive for all idle segments 200 seconds or less. For idle segments more than 200 seconds, place the transmission in park or neutral at the start of the idle segment and place the transmission into drive again no earlier than 5 seconds before the first nonzero vehicle speed setpoint.
- 3) For hybrid engines, you may request to change the engine-commanded torque at idle to better represent curb idle transmission torque (CITT).
- 4) For plug-in hybrid engines and powertrains, determine criteria pollutant and greenhouse gas emissions as described in § 1036.510(d) and (e), replacing "SET" with "LLC".

BILLING CODE 6560-50-C

(b) *Test configuration.* Select a powertrain for testing as described in § 1036.235 or 40 CFR 1037.235 as

applicable. Set up the engine according to 40 CFR 1065.110 and 1065.405(b). Set the engine's idle speed to idle speed defined in 40 CFR 1037.520(h)(1).

(1) The default test configuration consists of a powertrain with all components upstream of the axle. This involves connecting the powertrain's output shaft directly to the dynamometer or to a gear box with a fixed gear ratio and measuring torque at the axle input shaft. You may instead set up the dynamometer to connect at the wheel hubs and measure torque at that location. The preceding sentence may apply if your powertrain configuration requires it, such as for hybrid powertrains or if you want to represent the axle performance with powertrain test results. You may alternatively test the powertrain with a chassis dynamometer if you measure speed and torque at the powertrain's output shaft or wheel hubs.

(2) For testing hybrid engines, connect the engine's crankshaft directly to the dynamometer and measure torque at that location.

(c) *Powertrain temperatures during testing.* Cool the powertrain during testing so temperatures for oil, coolant, block, head, transmission, battery, and power electronics are within the manufacturer's expected ranges for normal operation. You may use electronic control module outputs to comply with this paragraph (c). You may use auxiliary coolers and fans.

(d) *Engine break in.* Break in the engine according to 40 CFR 1065.405(c), the axle assembly according to 40 CFR 1037.560, and the transmission according to 40 CFR 1037.565. You may instead break in the powertrain as a complete system using the engine break in procedure in 40 CFR 1065.405(c).

(e) *Dynamometer setup.* Set the dynamometer to operate in speed-control mode (or torque-control mode for hybrid engine testing at idle, including idle portions of transient duty cycles). Record data as described in 40 CFR 1065.202. Command and control

the dynamometer speed at a minimum of 5 Hz, or 10 Hz for testing hybrid engines. Run the vehicle model to calculate the dynamometer setpoints at a rate of at least 100 Hz. If the dynamometer's command frequency is less than the vehicle model dynamometer setpoint frequency, subsample the calculated setpoints for commanding the dynamometer setpoints.

(f) *Driveline and vehicle model.* Use the GEM HIL model's driveline and vehicle submodels or the equations in this paragraph (f) to calculate the dynamometer speed setpoint,  $f_{nref,dyno}$ , based on the torque measurement location. For all powertrains, configure GEM with the accessory load set to zero. For hybrid engines, configure GEM with the applicable accessory load as specified in §§ 1036.505, 1036.514, and 1036.525. For all powertrains and hybrid engines, configure GEM with the tire slip model disabled.

(1) *Driveline model with a transmission in hardware.* For testing with torque measurement at the axle input shaft or wheel hubs, calculate,  $f_{nref,dyno}$ , using the GEM HIL model's driveline submodel or the following equation:

$$f_{nrefi,dyno} = \frac{k_{a[speed]} \cdot v_{refi}}{2 \cdot \pi \cdot r_{[speed]}}$$

Eq. 1036.545-1

Where:

$k_{a[speed]}$  = drive axle ratio as determined in paragraph (h) of this section. Set  $k_{a[speed]}$  equal to 1.0 if torque is measured at the wheel hubs.

$v_{refi}$  = simulated vehicle reference speed as calculated in paragraph (f)(3) of this section.

$r_{[speed]}$  = tire radius as determined in paragraph (h) of this section.

(2) *Driveline model with a simulated transmission.* For testing with the torque

$$f_{ni,transmission} = \frac{k_{a[speed]} \cdot v_{refi}}{2 \cdot \pi \cdot r_{[speed]}}$$

Eq. 1036.545-2

Where:

$k_{a[speed]}$  = drive axle ratio as determined in paragraph (h) of this section.

$v_{refi}$  = simulated vehicle reference speed as calculated in paragraph (f)(3) of this section.

$r_{[speed]}$  = tire radius as determined in paragraph (h) of this section.

(ii) The transmission submodel generates the following model outputs:  
 (A) Dynamometer target speed.  
 (B) Dynamometer idle load.

(C) Transmission engine load limit.

(D) Engine speed target.

(3) *Vehicle model.* Calculate the simulated vehicle reference speed,  $v_{refi}$ , using the GEM HIL model's vehicle submodel or the equations in this paragraph (f)(3):

Eq. 1036.545-3

Where:

$i$  = a time-based counter corresponding to each measurement during the sampling period.

measurement at the engine's crankshaft,  $f_{nref,dyno}$  is the dynamometer target speed from the GEM HIL model's transmission submodel. You may request our approval to change the transmission submodel, as long as the changes do not affect the gear selection logic. Before testing, initialize the transmission model with the engine's measured torque curve and the applicable steady-state fuel map from the GEM HIL model. You may request our approval to input your own steady-state fuel map. For example, this request for approval could include using a fuel map that represents the combined performance of the engine and hybrid components. Configure the torque converter to simulate neutral idle when using this procedure to generate engine fuel maps in § 1036.505 or to perform the Supplemental Emission Test (SET) testing under § 1036.510. You may change engine commanded torque at idle to better represent CITT for transient testing under § 1036.512. You may change the simulated engine inertia to match the inertia of the engine under test. We will evaluate your requests under this paragraph (f)(2) based on your demonstration that the adjusted testing better represents in-use operation.

(i) The transmission submodel needs the following model inputs:

(A) Torque measured at the engine's crankshaft.

(B) Engine estimated torque determined from the electronic control module or by converting the instantaneous operator demand to an instantaneous torque in N-m.

(C) Dynamometer mode when idling (speed-control or torque-control).

(D) Measured engine speed when idling.

(E) Transmission output angular speed,  $f_{ni,transmission}$ , calculated as follows:

Let  $v_{refi} = 0$ ; start calculations at  $i = 2$ . A 10-minute sampling period will generally involve 60,000 measurements.

$T$  = instantaneous measured torque at the axle input, measured at the wheel hubs, or simulated by the GEM HIL model's transmission submodel. For configurations with multiple torque measurements, such as when measuring torque at the wheel hubs,  $T$  is the sum of all torque measurements.

$Eff_{axle}$  = axle efficiency. Use  $Eff_{axle} = 0.955$  for  $T \geq 0$ , and use  $Eff_{axle} = 1/0.955$  for  $T < 0$ .

Use  $Eff_{axle} = 1.0$  if torque is measured at the wheel hubs.  
 $M$  = vehicle mass for a vehicle class as determined in paragraph (h) of this section.  
 $g$  = gravitational constant = 9.80665 m/s<sup>2</sup>.  
 $C_{rr}$  = coefficient of rolling resistance for a vehicle class as determined in paragraph (h) of this section.  
 $G_{i-1}$  = the percent grade interpolated at distance,  $D_{i-1}$ , from the duty cycle in 40 CFR part 1037, appendix D, corresponding to measurement ( $i-1$ ).

$$D_{i-1} = \sum_{i=1}^N (v_{ref,i-1} \cdot \Delta t_{i-1})$$

Eq. 1036.545-4  
 $\rho$  = air density at reference conditions. Use  $\rho = 1.1845 \text{ kg/m}^3$ .  
 $C_{dA}$  = drag area for a vehicle class as determined in paragraph (h) of this section.  
 $F_{brake,i-1}$  = instantaneous braking force applied by the driver model.  
 $F_{grade,i-1} = M \cdot g \cdot \sin(\text{atan}(G_{i-1}))$   
 Eq. 1036.545-5  
 $\Delta t$  = the time interval between measurements. For example, at 100 Hz,  $\Delta t = 0.0100$  seconds.  
 $M_{rotating}$  = inertial mass of rotating components. Let  $M_{rotating} = 340 \text{ kg}$  for vocational Light HDV or vocational Medium HDV. See paragraph (h) of this section for tractors and for vocational Heavy HDV.

(4) *Example.* The following example illustrates a calculation of  $f_{nref,dyno}$  using paragraph (f)(1) of this section where torque is measured at the axle input shaft. This example is for a vocational Light HDV or vocational Medium HDV with 6 speed automatic transmission at B speed (test 4 in table 1 to paragraph (h)(2)(ii) of this section).  
 $k_{aB} = 4.0$   
 $r_B = 0.399 \text{ m}$   
 $T_{999} = 500.0 \text{ N}\cdot\text{m}$   
 $C_{rr} = 7.7 \text{ N/kN} = 7.7 \cdot 10^{-3} \text{ N/N}$   
 $M = 11408 \text{ kg}$   
 $C_{dA} = 5.4 \text{ m}^2$   
 $G_{999} = 0.39\% = 0.0039$

$$D_{999} = \sum_{i=0}^{998} (19.99 \cdot 0.01 + 20.0 \cdot 0.01 + \dots + v_{ref,998} \cdot \Delta t_{998}) = 1792 \text{ m}$$

$F_{brake,999} = 0 \text{ N}$   
 $v_{ref,999} = 20.0 \text{ m/s}$

$F_{grade,999} = 11408 \cdot 9.81 \cdot \sin(\text{atan}(0.0039)) = 436.5 \text{ N}$   
 $\Delta t = 0.0100 \text{ s}$

$M_{rotating} = 340 \text{ kg}$   
 $v_{ref1000} =$

$$\left( \frac{4.0 \cdot 500.0}{0.399} \cdot (0.955) - \left( (11408 \cdot 9.80665 \cdot 7.7 \cdot 10^{-3} \cdot \cos(\text{atan}(0.0039))) + \frac{1.1845 \cdot 5.4}{2} \cdot 20.0^2 \right) - 0 - 436.5 \right) \cdot \frac{0.0100}{11408 + 340} + 20.0 v_{ref1000}$$

$$v_{ref1000} = 20.00189 \text{ m/s}$$

$$f_{nref1000,dyno} = \frac{4.0 \cdot 20.00189}{2 \cdot 3.14 \cdot 0.399}$$

$$f_{nref1000,dyno} = 31.93 \text{ r/s} = 1915.8 \text{ r/min}$$

(g) *Driver model.* Use the GEM HIL model's driver submodel or design a driver model to simulate a human driver modulating the throttle and brake pedals. In either case, tune the model to follow the test cycle as closely as possible meeting the following specifications:

- (1) The driver model must meet the following speed requirements:
  - (i) For operation over the highway cruise cycles, the speed requirements described in 40 CFR 1066.425(b) and (c).
  - (ii) For operation over the Heavy-Duty Transient Test Cycle specified in 40

CFR part 1037, appendix A, the SET as defined § 1036.510, the Federal Test Procedure (FTP) as defined in § 1036.512, and the Low Load Cycle (LLC) as defined in § 1036.514, the speed requirements described in 40 CFR 1066.425(b) and (c).

(iii) The exceptions in 40 CFR 1066.425(b)(4) apply to the highway cruise cycles, the Heavy-Duty Transient Test Cycle specified in 40 CFR part 1037, appendix A, SET, FTP, and LLC.

(iv) If the speeds do not conform to these criteria, the test is not valid and must be repeated.

(2) Send a brake signal when operator demand is zero and vehicle speed is greater than the reference vehicle speed from the test cycle. Include a delay before changing the brake signal to prevent dithering, consistent with good engineering judgment.

(3) Allow braking only if operator demand is zero.

(4) Compensate for the distance driven over the duty cycle over the course of the test. Use the following equation to perform the compensation in real time to determine your time in the cycle:



$$t_{\text{cycle}i} = \sum_{i=1}^N \left( \left( \frac{v_{\text{vehicle},i-1}}{v_{\text{cycle},i-1}} \right) \cdot \Delta t_{i-1} \right)$$

Eq. 1036.545-6

Where:

$\omega_{\text{vehicle}}$  = measured vehicle speed.

$\omega_{\text{cycle}}$  = reference speed from the test cycle.

If  $\omega_{\text{cycle},i-1} < 1.0$  m/s, set  $\omega_{\text{cycle},i-1} = \omega_{\text{vehicle},i-1}$ .

(h) *Vehicle configurations to evaluate for generating fuel maps as defined in § 1036.505.* Configure the driveline and vehicle models from paragraph (f) of this section in the test cell to test the powertrain. Simulate multiple vehicle configurations that represent the range of intended vehicle applications using one of the following options:

(1) For known vehicle configurations, use at least three equally spaced axle ratios or tire sizes and three different road loads (nine configurations), or at least four equally spaced axle ratios or tire sizes and two different road loads

(eight configurations). Select axle ratios to represent the full range of expected vehicle installations. Select axle ratios and tire sizes such that the ratio of engine speed to vehicle speed covers the range of ratios of minimum and maximum engine speed to vehicle speed when the transmission is in top gear for the vehicles in which the powertrain will be installed. Note that you do not have to use the same axle ratios and tire sizes for each GEM regulatory subcategory. You may determine appropriate  $C_{rr}$ ,  $C_dA$ , and mass values to cover the range of intended vehicle applications or you may use the  $C_{rr}$ ,  $C_dA$ , and mass values specified in paragraph (h)(2) of this section.

(2) If vehicle configurations are not known, determine the vehicle model inputs for a set of vehicle configurations

as described in § 1036.540(c)(3) with the following exceptions:

(i) In the equations of § 1036.540(c)(3)(i),  $k_{\text{topgear}}$  is the actual top gear ratio of the powertrain instead of the transmission gear ratio in the highest available gear given in table 1 to paragraph (c)(2) of § 1036.540.

(ii) Test at least eight different vehicle configurations for powertrains that will be installed in Spark-ignition HDE, vocational Light HDV, and vocational Medium HDV using the following table instead of table 2 to paragraph (c)(3)(ii) of § 1036.540:

**TABLE 1 TO PARAGRAPH (h)(2)(ii) OF § 1036.545—VEHICLE CONFIGURATIONS FOR TESTING SPARK-IGNITION HDE, AND MEDIUM HDE**

Parameter	1	2	3	4	5	6	7	8
$C_{rr}$ (N/kN)	6.2	7.7	6.2	7.7	6.2	7.7	6.2	7.7
$C_dA$	3.4	5.4	3.4	5.4	3.4	5.4	3.4	5.4
CI engine speed for $\frac{f_{\text{ntire}}}{v_{\text{vehicle}}}$ and $k_a$	$f_{\text{refA}}$	$f_{\text{refA}}$	$f_{\text{refB}}$	$f_{\text{refB}}$	$f_{\text{refC}}$	$f_{\text{refC}}$	$f_{\text{test}}$	$f_{\text{test}}$
SI engine speed for $\frac{f_{\text{ntire}}}{v_{\text{vehicle}}}$ and $k_a$	$f_{\text{refD}}$	$f_{\text{refD}}$	$f_{\text{refA}}$	$f_{\text{refA}}$	$f_{\text{refB}}$	$f_{\text{refB}}$	$f_{\text{refC}}$	$f_{\text{refC}}$
$M$ (kg)	7,257	11,408	7,257	11,408	7,257	11,408	7,257	11,408
$M_{\text{rotating}}$ (kg)	340	340	340	340	340	340	340	340
Drive axle configuration <sup>a</sup>	4x2	4x2	4x2	4x2	4x2	4x2	4x2	4x2
GEM regulatory subcategory <sup>a</sup>	LHD	MHD	LHD	MHD	LHD	MHD	LHD	MHD

<sup>a</sup>Drive axle configuration and GEM regulatory subcategory are not used if using the equations in paragraph (f)(3) of this section.

(iii) Select and test vehicle configurations as described in § 1036.540(c)(3)(iii) for powertrains that will be installed in vocational Heavy HDV and tractors using the following

tables instead of tables 3 and 4 to paragraph (c)(3)(iii) of § 1036.540:

**TABLE 2 TO PARAGRAPH (h)(2)(iii) OF § 1036.545—VEHICLE CONFIGURATIONS FOR TESTING GENERAL PURPOSE TRACTORS AND VOCATIONAL HEAVY HDV**

Parameter	1	2	3	4	5	6	7	8	9
$C_{tr}$ (N/kN)	6.9	6.9	6.9	6.9	6.9	6.9	6.9	6.9	6.9
$C_dA$	5.4	4.7	4.0	5.4	4.7	4.0	5.4	4.7	4.0
Engine speed for $\frac{f_{nure}}{v_{vehicle}}$ and $k_a$	$f_{nrefD}$	$f_{nrefD}$	$f_{nrefD}$	$f_{nrefB}$	$f_{nrefB}$	$f_{nrefB}$	$f_{ntest}$	$f_{ntest}$	$f_{ntest}$
$M$ (kg)	31,978	25,515	19,051	31,978	25,515	19,051	31,978	25,515	19,051
$M_{rotating}$ (kg)	1,021	794	794	1,021	794	794	1,021	794	794
Drive axle configuration <sup>a</sup>	6x4	6x4	4x2	6x4	6x4	4x2	6x4	6x4	4x2
GEM regulatory subcategory <sup>a</sup>	C8_SC_HR	C8_DC_MR	C7_DC_MR	C8_SC_HR	C8_DC_MR	C7_DC_MR	C8_SC_HR	C8_DC_MR	C7_DC_MR
Vehicle weight reduction (lbs)	0	13,275	6,147	0	13,275	6,147	0	13,275	6,147

<sup>a</sup>Drive axle configuration and GEM regulatory subcategory are not used if using the equations in paragraph (f)(3) of this section.

TABLE 3 TO PARAGRAPH (h)(2)(iii) of § 1036.545—VEHICLE CONFIGURATIONS FOR TESTING HEAVY HDE INSTALLED IN HEAVY-HAUL TRACTORS

Parameter	1	2	3	4	5	6
$C_{tr}$ (N/kN)	6.9	6.9	6.9	6.9	6.9	6.9
$C_dA$	5.0	5.4	5.0	5.4	5.0	5.4
Engine speed for $\frac{f_{nure}}{v_{vehicle}}$ and $k_a$	$f_{nrefD}$	$f_{nrefD}$	$f_{nrefB}$	$f_{nrefB}$	$f_{ntest}$	$f_{ntest}$
$M$ (kg)	53,751	31,978	53,751	31,978	53,751	31,978
$M_{rotating}$ (kg)	1,021	1,021	1,021	1,021	1,021	1,021
Drive axle configuration <sup>a</sup>	6x4	6x4	6x4	6x4	6x4	6x4
GEM regulatory subcategory <sup>a</sup>	C8_HH	C8_SC_HR	C8_HH	C8_SC_HR	C8_HH	C8_SC_HR

<sup>a</sup>Drive axle configuration and GEM regulatory subcategory are not used if using the equations in paragraph (f)(3) of this section.

(3) For hybrid powertrain systems where the transmission will be simulated, use the transmission parameters defined in § 1036.540(c)(2) to determine transmission type and gear ratio. Use a fixed transmission efficiency of 0.95. The GEM HIL transmission model uses a transmission parameter file for each test that includes the transmission type, gear ratios, lockup gear, torque limit per gear from § 1036.540(c)(2), and the values from § 1036.505(b)(4) and (c).

(i) [Reserved]

(j) *Duty cycles to evaluate.* Operate the powertrain over each of the duty cycles specified in 40 CFR 1037.510(a)(2), and for each applicable vehicle configuration from paragraph (h) of this section. Determine cycle-average powertrain fuel maps by testing the powertrain using the procedures in § 1036.540(d) with the following exceptions:

(1) Understand “engine” to mean “powertrain”.

(2) Warm up the powertrain as described in § 1036.520(d).

(3) Within 90 seconds after concluding the warm-up, start the transition to the preconditioning cycle as described in paragraph (j)(5) of this section.

(4) For plug-in hybrid engines, precondition the battery and then complete all back-to-back tests for each vehicle configuration according to 40 CFR 1066.501(a)(3) before moving to the next vehicle configuration. The

following figure illustrates a charge-depleting test sequence with engine operation during two duty cycles, which

are used for criteria pollutant determination:

**Figure 2 to Paragraph (j)(4) of § 1036.545—Generic Charge-Depleting Test Sequence**

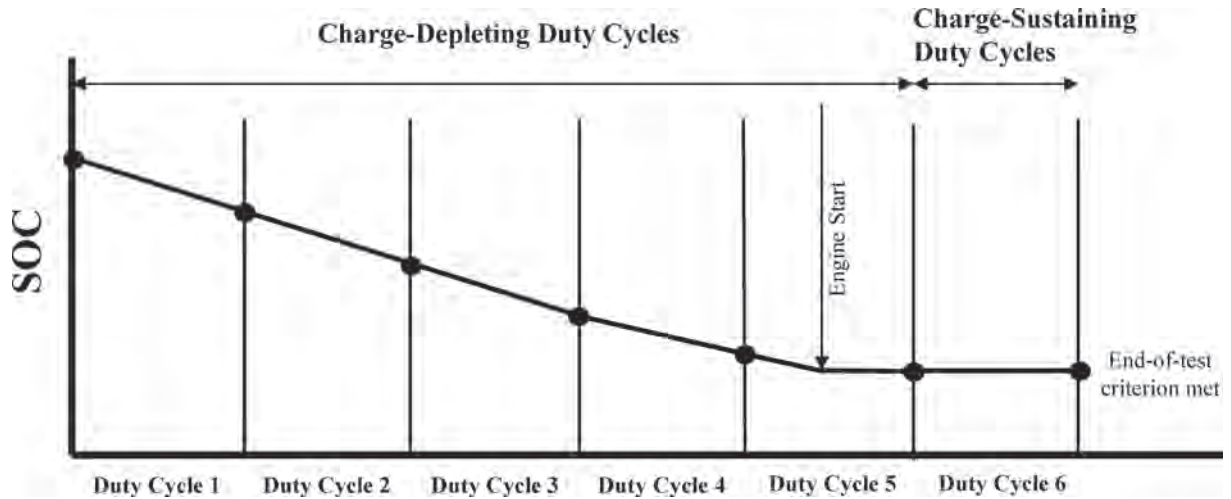

(5) If the preceding duty cycle does not end at 0 mi/hr, transition between duty cycles by decelerating at a rate of 2 mi/hr/s at 0% grade until the vehicle reaches zero speed. Shut off the powertrain. Prepare the powertrain and test cell for the next duty-cycle.

(6) Start the next duty-cycle within 60 to 180 seconds after shutting off the powertrain.

(i) To start the next duty-cycle, for hybrid powertrains, key on the vehicle and then start the duty-cycle. For conventional powertrains key on the vehicle, start the engine, wait for the engine to stabilize at idle speed, and then start the duty-cycle.

(ii) If the duty-cycle does not start at 0 mi/hr, transition to the next duty cycle by accelerating at a target rate of 1 mi/hr/s at 0% grade. Stabilize for 10 seconds at the initial duty cycle conditions and start the duty-cycle.

(7) Calculate cycle work using GEM or the speed and torque from the driveline and vehicle models from paragraph (f) of this section to determine the sequence of duty cycles.

(8) Calculate the mass of fuel consumed for idle duty cycles as described in paragraph (n) of this section.

(k) *Measuring NO<sub>x</sub> emissions.* Measure NO<sub>x</sub> emissions for each sampling period in grams. You may perform these measurements using a NO<sub>x</sub> emission-measurement system that meets the requirements of 40 CFR part 1065, subpart J. If a system malfunction prevents you from measuring NO<sub>x</sub> emissions during a test under this section but the test otherwise gives valid results, you may consider this a valid test and omit the NO<sub>x</sub> emission measurements; however, we may require you to repeat the test if we determine that you inappropriately

voided the test with respect to NO<sub>x</sub> emission measurement.

(l) [Reserved]

(m) *Measured output speed validation.* For each test point, validate the measured output speed with the corresponding reference values. If speed is measured at more than one location, the measurements at each location must meet validation requirements. If the range of reference speed is less than 10 percent of the mean reference speed, you need to meet only the standard error of the estimate in table 4 to this paragraph (m). You may delete points when the vehicle is stopped. If your speed measurement is not at the location of  $f_{nref}$ , correct your measured speed using the constant speed ratio between the two locations. Apply cycle-validation criteria for each separate transient or highway cruise cycle based on the following parameters:

**TABLE 4 TO PARAGRAPH (m) OF § 1036.545—CYCLE-VALIDATION CRITERIA**

Parameter <sup>a</sup>	Speed control
Slope, $a_1$ .....	$0.990 \leq a_1 \leq 1.010$ .
Absolute value of intercept, $ a_0 $ .....	$\leq 2.0\%$ of maximum $f_{nref}$ speed.
Standard error of the estimate, <i>SEE</i> .....	$\leq 2.0\%$ of maximum $f_{nref}$ speed.
Coefficient of determination, $r^2$ .....	$\geq 0.990$ .

<sup>a</sup> Determine values for specified parameters as described in 40 CFR 1065.514(e) by comparing measured and reference values for  $f_{nref,dyno}$ .

(n) *Fuel consumption at idle.* Record measurements using direct and/or indirect measurement of fuel flow. Determine the fuel-consumption rates at idle for the applicable duty cycles described in 40 CFR 1037.510(a)(2) as follows:

(1) *Direct fuel flow measurement.* Determine the corresponding mean values for mean idle fuel mass flow rate,  $\bar{m}_{fuel, idle}$ , for each duty cycle, as applicable. Use of redundant direct fuel-flow measurements require our advance approval.

(2) *Indirect fuel flow measurement.* Record speed and torque and measure emissions and other inputs needed to run the chemical balance in 40 CFR 1065.655(c). Determine the corresponding mean values for each duty cycle. Use of redundant indirect fuel-flow measurements require our

advance approval. Measure background concentration as described in § 1036.535(b)(4)(ii). We recommend setting the CVS flow rate as low as possible to minimize background, but

without introducing errors related to insufficient mixing or other operational considerations. Note that for this testing 40 CFR 1065.140(e) does not apply, including the minimum dilution ratio of

2:1 in the primary dilution stage. Calculate the idle fuel mass flow rate for each duty cycle,  $\bar{m}_{fuelidle}$ , for each set of vehicle settings, as follows:

$$\bar{m}_{fuelidle} = \frac{M_C}{w_{Cmeas}} \cdot \left( \bar{n}_{exh} \cdot \frac{\bar{\chi}_{Ccombdry}}{1 + \bar{\chi}_{H2Oexhdry}} - \frac{\bar{m}_{CO2DEF}}{M_{CO2}} \right)$$

Eq. 1036.545-7

Where:

$M_C$  = molar mass of carbon.

$w_{Cmeas}$  = carbon mass fraction of fuel (or mixture of test fuels) as determined in 40 CFR 1065.655(d), except that you may not use the default properties in 40 CFR 1065.655(e)(5) to determine  $\alpha$ ,  $\beta$ , and  $w_C$  for liquid fuels.

$\bar{n}_{exh}$  = the mean raw exhaust molar flow rate from which you measured emissions according to 40 CFR 1065.655.

$\bar{\chi}_{Ccombdry}$  = the mean concentration of carbon from fuel and any injected fluids in the exhaust per mole of dry exhaust.

$\bar{\chi}_{H2Oexhdry}$  = the mean concentration of H<sub>2</sub>O in exhaust per mole of dry exhaust.

$\bar{m}_{CO2DEF}$  = the mean CO<sub>2</sub> mass emission rate resulting from diesel exhaust fluid decomposition over the duty cycle as determined in § 1036.535(b)(9). If your engine does not use diesel exhaust fluid, or if you choose not to perform this correction, set equal to 0.

$M_{CO2}$  = molar mass of carbon dioxide.

Example:

$M_C = 12.0107$  g/mol

$w_{Cmeas} = 0.867$

$\bar{n}_{exh} = 25.534$  mol/s

$\bar{\chi}_{Ccombdry} = 2.805 \cdot 10^{-3}$  mol/mol

$\bar{\chi}_{H2Oexhdry} = 3.53 \cdot 10^{-2}$  mol/mol

$\bar{m}_{CO2DEF} = 0.0726$  g/s

$M_{CO2} = 44.0095$

$$\bar{m}_{fuelidle} = \frac{12.0107}{0.867} \cdot \left( 25.534 \cdot \frac{2.805 \cdot 10^{-3}}{1 + 3.53 \cdot 10^{-2}} - \frac{0.0726}{44.0095} \right)$$

$$\bar{m}_{fuelidle} = 0.405 \text{ g/s} = 1458.6 \text{ g/hr}$$

(o) *Create GEM inputs.* Use the results of powertrain testing to determine GEM inputs for the different simulated vehicle configurations as follows:

(1) Correct the measured or calculated fuel masses,  $m_{fuel[cycle]}$ , and mean idle fuel mass flow rates,  $\bar{m}_{fuelidle}$ , if applicable, for each test result to a mass-specific net energy content of a reference fuel as described in § 1036.535(e), replacing  $\bar{m}_{fuel}$  with  $m_{fuel[cycle]}$  where applicable in Eq. 1036.535-4.

(2) Declare fuel masses,  $m_{fuel[cycle]}$  and  $\bar{m}_{fuelidle}$ . Determine  $m_{fuel[cycle]}$  using the calculated fuel mass consumption values described in § 1036.540(d)(12). In addition, declare mean fuel mass flow rate for each applicable idle duty cycle,  $\bar{m}_{fuelidle}$ . These declared values may not be lower than any corresponding measured values determined in this section. If you use both direct and indirect measurement of fuel flow, determine the corresponding declared values as described in § 1036.535(g)(2)

and (3). These declared values, which serve as emission standards, collectively represent the powertrain fuel map for certification.

(3) For engines designed for plug-in hybrid electric vehicles, the mass of fuel for each cycle,  $m_{fuel[cycle]}$ , is the utility factor-weighted fuel mass,  $m_{fuelUF[cycle]}$ . This is determined by calculating  $m_{fuel}$  for the full charge-depleting and charge-sustaining portions of the test and weighting the results, using the following equation:

$$m_{fuelUF[cycle]} = \sum_{i=1}^N [m_{fuel[cycle]CDi} \cdot (UF_{DCDi} - UF_{DCDi-1})] + \sum_{j=1}^M [m_{fuel[cycle]CSj}] \cdot \frac{(1 - UF_{RCD})}{M}$$

Eq. 1036.545-8

Where:

$i$  = an indexing variable that represents one test interval.

$N$  = total number of charge-depleting test intervals.

$m_{fuel[cycle]CDi}$  = total mass of fuel in the charge-depleting portion of the test for each test interval,  $i$ , starting from  $i = 1$ , including the test interval(s) from the transition phase.

$UF_{DCDi}$  = utility factor fraction at distance  $D_{CDi}$  from Eq. 1036.510-11 as determined by interpolating the approved utility factor curve for each test interval,  $i$ , starting from  $i = 1$ . Let  $UF_{DCD0} = 0$

$j$  = an indexing variable that represents one test interval.

$M$  = total number of charge-sustaining test intervals.

$m_{fuel[cycle]CSj}$  = total mass of fuel over the charge-sustaining portion of the test for each test interval,  $j$ , starting from  $j = 1$ .

$UF_{RCD}$  = utility factor fraction at the full charge-depleting distance,  $R_{CD}$ , as determined by interpolating the approved utility factor curve.  $R_{CD}$  is the cumulative distance driven over  $N$  charge-depleting test intervals.

$$D_{CDi} = \sum_{k=1}^Q (v_k \cdot \Delta t)$$

Eq. 1036.545-9

Where:

$k$  = an indexing variable that represents one recorded velocity value.

$Q$  = total number of measurements over the test interval.

$v$  = vehicle velocity at each time step,  $k$ , starting from  $k = 1$ . For tests completed under this section,  $v$  is the vehicle velocity as determined by Eq. 1036.545-1. Note that this should include charge-

depleting test intervals that start when the engine is not yet operating.  
 $\Delta t = 1/f_{\text{record}}$   
 $f_{\text{record}}$  = the record rate.

Example for the 55 mi/hr cruise cycle:  $v_3 = 55.1$  mi/hr  
 $Q = 8790$   
 $v_1 = 55.0$  mi/hr  
 $v_2 = 55.0$  mi/hr  
 $f_{\text{record}} = 10$  Hz  
 $\Delta t = 1/10$  Hz = 0.1 s

$$D_{\text{CD1}} = \sum_{k=1}^{8790} (55.0 \cdot 0.1 + 55.0 \cdot 0.1 + 55.1 \cdot 0.1 + v_{8790} \cdot \Delta t) = 13.4 \text{ mi}$$

$$D_{\text{CD2}} = 13.4 \text{ mi}$$

$$D_{\text{CD3}} = 13.4 \text{ mi}$$

$$N = 3$$

$$UF_{\text{DCD1}} = 0.05$$

$$UF_{\text{DCD2}} = 0.11$$

$$UF_{\text{DCD3}} = 0.21$$

$$m_{\text{fuel55cruiseCD1}} = 0 \text{ g}$$

$$m_{\text{fuel55cruiseCD2}} = 0 \text{ g}$$

$$m_{\text{fuel55cruiseCD3}} = 1675.4 \text{ g}$$

$$M = 1$$

$$m_{\text{fuel55cruiseCS}} = 4884.1 \text{ g}$$

$$UF_{\text{RCD}} = 0.21$$

$$m_{\text{fuelUF55cruise}} = \frac{[0 \cdot (0.05 - 0) + 0 \cdot (0.11 - 0.05) + 1675.4 \cdot (0.21 - 0.11)] + 4884.1}{(1 - 0.21)}$$

$$m_{\text{fuelUF55cruise}} = 4026.0 \text{ g}$$

(4) For the transient cycle specified in 40 CFR 1037.510(a)(2)(i), calculate powertrain output speed per unit of vehicle speed using one of the following methods:

(i) For testing with torque measurement at the axle input shaft:

Eq. 1036.545-10

Example:

$$\left[ \frac{\bar{f}_{\text{npowertrain}}}{\bar{v}_{\text{powertrain}}} \right]_{\text{[cycle]}} = \frac{k_a}{2 \cdot \pi \cdot r_{\text{[speed]}}}$$

$$k_a = 4.0$$

$$r_B = 0.399 \text{ m}$$

$$\left[ \frac{\bar{f}_{\text{npowertrain}}}{\bar{v}_{\text{powertrain}}} \right]_{\text{transienttest4}} = \frac{4.0}{2 \cdot 3.14 \cdot 0.399}$$

$$\left[ \frac{\bar{f}_{\text{npowertrain}}}{\bar{v}_{\text{powertrain}}} \right]_{\text{transienttest4}} = 1.596 \text{ r/m}$$

(ii) For testing with torque measurement at the wheel hubs, use Eq. 1036.545-8 setting  $k_a$  equal to 1.

$$\left[ \frac{\bar{f}_{\text{npowertrain}}}{\bar{v}_{\text{powertrain}}} \right]_{\text{[cycle]}} = \frac{\bar{f}_{\text{nengine}}}{\bar{v}_{\text{ref}}}$$

$\oplus$   $f_{\text{nengine}}$  = average engine speed when vehicle speed is at or above 0.100 m/s.  
 $\oplus$   $v_{\text{ref}}$  = average simulated vehicle speed at or above 0.100 m/s.

(iii) For testing with torque measurement at the engine's crankshaft:

Eq. 1036.545-11  
 Where:

Example:

$$\begin{aligned} \bar{f}_{\text{engine}} &= 1870 \text{ r/min} = 31.17 \text{ r/s} \\ \bar{v}_{\text{ref}} &= 19.06 \text{ m/s} \\ \left[ \frac{\bar{f}_{\text{powertrain}}}{\bar{v}_{\text{powertrain}}} \right]_{\text{transienttest4}} &= \frac{31.17}{19.06} \\ \left[ \frac{\bar{f}_{\text{powertrain}}}{\bar{v}_{\text{powertrain}}} \right]_{\text{transienttest4}} &= 1.635 \text{ r/m} \end{aligned}$$

(5) Calculate engine idle speed, by taking the average engine speed measured during the transient cycle test while the vehicle speed is below 0.100 m/s. (Note: Use all the charge-sustaining test intervals when determining engine idle speed for plug-in hybrid powertrains.)

(6) For the cruise cycles specified in 40 CFR 1037.510(a)(2)(ii), calculate the average powertrain output speed,  $\bar{f}_{\text{powertrain}}$ , and the average powertrain output torque (positive torque only),  $\bar{T}_{\text{powertrain}}$ , at vehicle speed at or above 0.100 m/s. (Note: Use all the charge-

sustaining and charge-depleting test intervals when determining  $\bar{f}_{\text{powertrain}}$  and  $\bar{T}_{\text{powertrain}}$  for plug-in hybrid powertrains.)

(7) Calculate positive work,  $W_{\text{[cycle]}}$ , as the work over the duty cycle at the axle input shaft, wheel hubs, or the engine's crankshaft, as applicable, when vehicle speed is at or above 0.100 m/s. For plug-in hybrid powertrains, calculate  $W_{\text{[cycle]}}$  by calculating the positive work over each of the charge-sustaining and charge-depleting test intervals and then averaging them together. If speed and torque are measured at more than one

location, determine  $W_{\text{[cycle]}}$  by integrating the sum of the power calculated from measured speed and torque measurements at each location.

(8) The following tables illustrate the GEM data inputs corresponding to the different vehicle configurations for a given duty cycle:

(i) For the transient cycle:

**Table 5 to Paragraph (o)(8)(i) of § 1036.545—Example of Output Matrix for Transient Cycle Vehicle Configurations**

Parameter	Configuration					
	1	2	3	4	...	n
$m_{\text{fuel[cycle]}}$						
$\left[ \frac{\bar{f}_{\text{powertrain}}}{\bar{v}_{\text{powertrain}}} \right]_{\text{[cycle]}}$						
$W_{\text{[cycle]}}$						
$\bar{f}_{\text{idle}}$						

(ii) For the cruise cycles:

**Table 6 to Paragraph (o)(8)(ii) of § 1036.545—Generic Example of Output Matrix for Cruise Cycle Vehicle Configurations**

Parameter	Configuration									
	1	2	3	4	5	6	7	...	n	
$m_{\text{fuel[cycle]}}$										
$\bar{f}_{\text{powertrain[cycle]}}$										
$\bar{T}_{\text{powertrain[cycle]}}$										
$W_{\text{[cycle]}}$										

(p) *Determine usable battery energy.* Determine usable battery energy (UBE) for plug-in hybrid powertrains using one of the following procedures:

(1) Select a representative vehicle configuration from paragraph (h) of this section. Measure DC discharge energy,  $E_{\text{DCD}}$ , in DC watt-hours and measure DC discharge current per hour,  $C_{\text{D}}$ , for the charge-depleting test intervals of the Heavy-Duty Transient Test Cycle in 40 CFR part 1037, appendix A. The measurement period must include all

the current flowing into and out of the battery pack during the charge-depleting test intervals, including current associated with regenerative braking. Eq. 1036.545-12 shows how to calculate  $E_{\text{DCD}}$ , but the power analyzer specified in paragraph (a)(10)(i) of this section will typically perform this calculation internally. Battery voltage measurements made by the powertrain's on-board sensors (such as those available with a diagnostic port) may be used for calculating  $E_{\text{DCD}}$  if they are

equivalent to those from the power analyzer.

$$E_{\text{DCD}} = \sum_{i=0}^N V_i \cdot I_i \cdot \Delta t$$

Eq. 1036.545-12

Where:

$i$  = an indexing variable that represents one individual measurement.  
 $N$  = total number of measurements.  
 $V$  = battery DC bus voltage.

$I$  = battery current.  
 $\Delta t = 1/f_{\text{record}}$   
 $f_{\text{record}}$  = the data recording frequency.  
 Example:

$N = 13360$   
 $V_1 = 454.0$   
 $V_2 = 454.0$   
 $I_1 = 0$

$I_2 = 0$   
 $f_{\text{record}} = 20 \text{ Hz}$   
 $\Delta t = 1/20 = 0.05 \text{ s}$

$$E_{\text{DCD}} = \sum_{i=0}^{13360} (454.0 \cdot 0 + 454.0 \cdot 0 + \dots + V_{13360} \cdot I_{13360}) \cdot 0.05$$

$$E_{\text{DCD}} = 6540232.7 \text{ W}\cdot\text{s} = 1816.7 \text{ W}\cdot\text{hr}$$

(2) Determine a declared *UBE* that is at or below the corresponding value determined in paragraph (p)(1) of this section, including those from redundant measurements. This declared *UBE* serves as *UBE<sub>certified</sub>* determined under 40 CFR 1037.115(f).

- 35. Amend § 1036.550 by:
  - a. Revising paragraphs (b)(1) and (2); and
  - b. Revising the entry for  $w_{\text{Cmeas}}$  in paragraph (b)(4) after the “Example”.

The revisions read as follows:

**§ 1036.550 Calculating greenhouse gas emission rates.**

\* \* \* \* \*

(b) \* \* \*

(1) Determine your test fuel’s mass-specific net energy content,  $E_{\text{mfuelmeas}}$ , also known as lower heating value, in MJ/kg, expressed to at least three decimal places. Determine  $E_{\text{mfuelmeas}}$  as follows:

(i) For liquid fuels, determine  $E_{\text{mfuelmeas}}$  according to ASTM D4809 (incorporated by reference, see § 1036.810). Have the sample analyzed by at least three different labs and determine the final value of your test fuel’s  $E_{\text{mfuelmeas}}$  as the median of all the lab test results as described in 40 CFR 1065.602(m). If you have results from three different labs, we recommend you screen them to determine if additional observations are needed. To perform this screening, determine the absolute value of the difference between each lab result and the average of the other two lab results. If the largest of these three resulting absolute value differences is greater than 0.297 MJ/kg, we recommend you obtain additional results prior to determining the final value of  $E_{\text{mfuelmeas}}$ .

(ii) For gaseous fuels, determine  $E_{\text{mfuelmeas}}$  according to ASTM D3588 (incorporated by reference, see § 1036.810).

(2) Determine your test fuel’s carbon mass fraction,  $w_{\text{C}}$ , as described in 40 CFR 1065.655(d), expressed to at least three decimal places; however, you must measure fuel properties for  $\alpha$  and  $\beta$  rather than using the default values specified in 40 CFR 1065.655(e).

(i) For liquid fuels, have the sample analyzed by at least three different labs, determine  $w_{\text{C}}$  for each result as described in 40 CFR 1065.655(d), and determine the final value of your test fuel’s  $w_{\text{C}}$  as the median (as described in 40 CFR 1065.602(m)) of all the  $w_{\text{C}}$  values. If you have results from three different labs, we recommend you screen them to determine if additional observations are needed. To perform this screening, determine the absolute value of the difference between each  $w_{\text{C}}$  value and the average of the other two  $w_{\text{C}}$  values. If the largest of these three resulting absolute value differences is greater than 1.56 percent carbon, we recommend you obtain additional results prior to determining the final value of  $w_{\text{C}}$ .

(ii) For gaseous fuels, have the sample analyzed by a single lab and use that result as your test fuel’s  $w_{\text{C}}$ .

(4) \* \* \*  
 $w_{\text{Cmeas}} = 0.870 \text{ kgC/kg}$   
 \* \* \* \* \*

- 36. Amend § 1036.580 by adding paragraph (d) to read as follows:

**§ 1036.580 Infrequently regenerating aftertreatment devices.**

\* \* \* \* \*

(d) If your engine family includes engines with one or more emergency AECs approved under § 1036.115(h)(4), do not consider additional regenerations resulting from those AECs when developing adjustments to measured values under paragraph (a) or (b) of this section.

- 37. Amend § 1036.601 by revising paragraph (c) to read as follows:

**§ 1036.601 Overview of compliance provisions.**

\* \* \* \* \*

(c) The emergency vehicle field modification provisions of 40 CFR 85.1716 apply with respect to the standards of this part. Emergency vehicle field modifications under 40 CFR 85.1716 may include corresponding changes to diagnostic systems relative to the requirements in §§ 1036.110 and 1036.111. For example,

the cab display required under § 1036.110(c)(1) identifying a fault condition may omit information about the timing or extent of a pending derate if an AECD will override the derate.

\* \* \* \* \*

- 38. Amend § 1036.605 by revising paragraph (e) to read as follows:

**§ 1036.605 Alternate emission standards for engines used in specialty vehicles.**

\* \* \* \* \*

(e) In a separate application for a certificate of conformity, identify the corresponding nonroad engine family, describe the label required under section, state that you meet applicable diagnostic requirements under 40 CFR part 1039 or 1048, and identify your projected U.S.-directed production volume.

\* \* \* \* \*

- 39. Amend § 1036.615 by revising paragraph (a) to read as follows:

**§ 1036.615 Engines with Rankine cycle waste heat recovery and hybrid powertrains.**

\* \* \* \* \*

(a) *Pre-transmission hybrid powertrains.* Test pre-transmission hybrid powertrains with the hybrid engine procedures of 40 CFR part 1065 or with the post-transmission procedures in § 1036.545. Pre-transmission hybrid powertrains are those engine systems that include features to recover and store energy during engine motoring operation but not from the vehicle’s wheels. Engines certified with pre-transmission hybrid powertrains must be certified to meet the diagnostic requirements as specified in § 1036.110 with respect to powertrain components and systems; if different manufacturers produce the engine and the hybrid powertrain, the hybrid powertrain manufacturer may separately certify its powertrain relative to diagnostic requirements.

\* \* \* \* \*

- 40. Amend § 1036.630 by revising paragraph (b) to read as follows:

**§ 1036.630 Certification of engine greenhouse gas emissions for powertrain testing.**

\* \* \* \* \*

(b) If you choose to certify only fuel map emissions for an engine family and to not certify emissions over powertrain cycles under § 1036.545, we will not presume you are responsible for emissions over the powertrain cycles.

However, where we determine that you are responsible in whole or in part for the emission exceedance in such cases, we may require that you participate in any recall of the affected vehicles (Note: this does not apply if you also hold the certificate of conformity for the vehicle).

\* \* \* \* \*

- 41. Amend § 1036.705 by revising paragraph (c) to read as follows:

**§ 1036.705 Generating and calculating emission credits.**

\* \* \* \* \*

(c) Compliance with the requirements of this subpart is determined at the end of the model year by calculating emission credits based on actual production volumes, excluding the following engines:

(1) Engines that you do not certify to the CO<sub>2</sub> standards of this part because they are permanently exempted under subpart G of this part or under 40 CFR part 1068.

(2) Exported engines.

(3) Engines not subject to the requirements of this part, such as those excluded under § 1036.5. For example, do not include engines used in vehicles certified to the greenhouse gas standards of 40 CFR 86.1819.

(4) Engines certified to state emission standards that are different than the emission standards referenced in this section, and intended for sale in a state that has adopted those emission standards.

(5) Any other engines if we indicate elsewhere in this part that they are not to be included in the calculations of this subpart.

\* \* \* \* \*

- 42. Amend § 1036.725 by revising paragraph (b)(2) to read as follows:

**§ 1036.725 Required information for certification.**

\* \* \* \* \*

(b) \* \* \*

(2) Calculations of projected emission credits (positive or negative) based on projected production volumes as described in § 1036.705(c). We may require you to include similar calculations from your other engine families to project your net credit balances for the model year. If you

project negative emission credits for a family, state the source of positive emission credits you expect to use to offset the negative emission credits.

- 43. Amend § 1036.730 by revising paragraphs (b)(4) and (f)(1) to read as follows:

**§ 1036.730 ABT reports.**

\* \* \* \* \*

(b) \* \* \*

(4) The projected and actual production volumes for calculating emission credits for the model year. If you changed an FEL/FCL during the model year, identify the actual production volume associated with each FEL/FCL.

\* \* \* \* \*

(f) \* \* \*

(1) If you notify us by the deadline for submitting the final report that errors mistakenly decreased your balance of emission credits, you may correct the errors and recalculate the balance of emission credits. If you notify us that errors mistakenly decreased your balance of GHG emission credits after the deadline for submitting the final report, you may correct the errors and recalculate the balance of emission credits after applying a 10 percent discount to the credit correction, but only if you notify us within 24 months after the deadline for submitting the final report. If you report a negative balance of emission credits, we may disallow corrections under this paragraph (f)(1).

\* \* \* \* \*

- 44. Amend § 1036.735 by revising paragraph (d) to read as follows:

**§ 1036.735 Recordkeeping.**

\* \* \* \* \*

(d) Keep appropriate records to document production volumes of engines that generate or use emission credits under the ABT program. For example, keep available records of the engine identification number (usually the serial number) for each engine you produce that generates or uses emission credits. You may identify these numbers as a range. If you change the FEL/FCL after the start of production, identify the date you started using each FEL/FCL and the range of engine identification numbers associated with each FEL/FCL. You must also identify the purchaser and destination for each engine you produce to the extent this information is available.

\* \* \* \* \*

- 45. Amend § 1036.801 by:

- a. Adding a definition of “Carbon-containing fuel” in alphabetical order;

- b. Removing the definition of “Criteria pollutants”;
- c. Revising the definition of “Emergency vehicle”;
- d. Removing the definition of “Greenhouse gas”;
- e. Revising the definition of “Hybrid”;
- f. Removing the definitions of “Hybrid engine” and “Hybrid powertrain”;
- g. Revising the definition of “Mild hybrid”;
- h. Adding a definition of “Neat” in alphabetical order;
- i. Revising the definition of “Small manufacturer”;
- j. Adding a definition of “State of certified energy (SOCE)” in alphabetical order; and
- k. Revising the definition of “U.S.-directed production volume”.

The additions and revisions read as follows:

**§ 1036.801 Definitions.**

\* \* \* \* \*

*Carbon-containing fuel* has the meaning given in 40 CFR 1065.1001.

\* \* \* \* \*

*Emergency vehicle* means a vehicle that meets one of the following criteria:

- (1) It is an ambulance or a fire truck.
- (2) It is a vehicle that we have determined will likely be used in emergency situations where emission control function or malfunction may cause a significant risk to human life. For example, we would consider a truck that is certain to be retrofitted with a slip-on firefighting module to become an emergency vehicle, even though it was not initially designed to be a fire truck. Also, a mobile command center that is unable to manually regenerate its DPF while on duty could be an emergency vehicle. In making this determination, we may consider any factor that has an effect on the totality of the actual risk to human life. For example, we may consider how frequently a vehicle will be used in emergency situations or how likely it is that the emission controls will cause a significant risk to human life when the vehicle is used in emergency situations. We would not consider the truck in the example above to be an emergency vehicle if there is merely a possibility (rather than a certainty) that it will be retrofitted with a slip-on firefighting module.

\* \* \* \* \*

*Hybrid* means relating to an engine or powertrain that includes a Rechargeable Energy Storage System. Hybrid engines store and recover energy in a way that is integral to the engine or otherwise upstream of the vehicle’s transmission. Examples of hybrid engines include



engines with hybrid components connected to the front end of the engine (P0), connected to the crankshaft before the clutch (P1), or connected between the clutch and the transmission where the clutch upstream of the hybrid feature is in addition to the transmission clutch or clutches (P2). Engine-based systems that recover kinetic energy to power an electric heater in the aftertreatment are themselves not sufficient to qualify as a hybrid engine. The provisions in this part that apply for hybrid powertrains apply equally for hybrid engines, except as specified. Note that certain provisions in this part treat hybrid powertrains intended for vehicles that include regenerative braking different than those intended for vehicles that do not include regenerative braking. The definition of hybrid includes plug-in hybrid electric powertrains.

*Mild hybrid* means relating to a hybrid engine or hybrid powertrain with regenerative braking capability where the system recovers less than 20 percent of the total braking energy over the transient cycle defined in 40 CFR part 1037, appendix A.

*Neat* has the meaning given in 40 CFR 1065.1001.

*Small manufacturer* means a manufacturer meeting the criteria specified in 13 CFR 121.201. The employee and revenue limits apply to the total number of employees and total revenue together for all affiliated companies (as defined in 40 CFR 1068.30). Note that manufacturers with low production volumes may or may not be “small manufacturers”.

*State of certified energy (SOCE)* means a value representing the amount of usable battery energy available at a specific point in time relative to the certified value for a new battery, expressed as a percentage of the certified usable battery energy.

*U.S.-directed production volume* means the number of engines, subject to the requirements of this part, produced by a manufacturer for which the manufacturer has a reasonable assurance that sale was or will be made to ultimate purchasers in the United States.

■ 46. Amend § 1036.805 by revising the introductory text and adding entries for “DPF” and “GCWR” in alphabetical

order to table 5 to paragraph (e) to read as follows:

**§ 1036.805 Symbols, abbreviations, and acronyms.**

The procedures in this part generally follow either the International System of Units (SI) or the United States customary units, as detailed in NIST Special Publication 811 (incorporated by reference, see § 1036.810). See 40 CFR 1065.20 for specific provisions related to these conventions. This section summarizes the way we use symbols, units of measure, and other abbreviations.

\* \* \* \* \*  
 (e) \* \* \*

TABLE 5 TO PARAGRAPH (e) OF § 1036.805—OTHER ACRONYMS AND ABBREVIATIONS

Acronym	Meaning
DPF	diesel particulate filter.
GCWR	gross combined weight rating.

■ 47. Amend § 1036.810 by adding paragraph (e) to read as follows:

**§ 1036.810 Incorporation by reference.**

(e) U.S. EPA, Office of Air and Radiation, 2565 Plymouth Road, Ann Arbor, MI 48105; [www.epa.gov/complianceinfo@epa.gov](http://www.epa.gov/complianceinfo@epa.gov).

(1) Greenhouse gas Emissions Model (GEM) Phase 2, Version 4.0, April 2022 (“GEM Phase 2, Version 4.0”); IBR approved for § 1036.545(a).

(2) [Reserved]

■ 48. Amend § 1036.815 by revising paragraph (b) to read as follows:

**§ 1036.815 Confidential information.**

(b) Emission data or information that is publicly available cannot be treated as confidential business information as described in 40 CFR 1068.11. Data that vehicle manufacturers need for demonstrating compliance with greenhouse gas emission standards, including fuel-consumption data as described in §§ 1036.535 and 1036.545, also qualify as emission data for purposes of confidentiality determinations.

**PART 1037—CONTROL OF EMISSIONS FROM NEW HEAVY-DUTY MOTOR VEHICLES**

■ 49. The authority citation for part 1037 continues to read as follows:

**Authority:** 42 U.S.C. 7401–7671q.

■ 50. Amend § 1037.1 by revising paragraph (a) to read as follows:

**§ 1037.1 Applicability.**

(a) The regulations in this part apply for all new heavy-duty vehicles, except as provided in § 1037.5. This includes battery electric vehicles, fuel cell electric vehicles, and vehicles fueled by conventional and alternative fuels.

■ 51. Amend § 1037.5 by:  
 ■ a. Revising paragraph (e);  
 ■ b. Removing paragraphs (g) and (h); and  
 ■ c. Redesignating paragraph (i) as paragraph (g).

The revision reads as follows:

**§ 1037.5 Excluded vehicles.**

(e) Vehicles subject to emission standards under 40 CFR part 86, subpart S.

■ 52. Revise and republish § 1037.101 to read as follows:

**§ 1037.101 Overview of emission standards.**

(a) You must show that vehicles meet the following emission standards:

(1) *Exhaust emissions of criteria pollutants.* Criteria pollutant standards for NO<sub>x</sub>, HC, PM, and CO apply as described in § 1037.102. These pollutants are sometimes described collectively as “criteria pollutants” because they are either criteria pollutants under the Clean Air Act or precursors to the criteria pollutants ozone and PM.

(2) *Exhaust emissions of greenhouse gases.* This part contains standards and other regulations applicable to the emission of the air pollutant defined as the aggregate group of six greenhouse gases: carbon dioxide, nitrous oxide, methane, hydrofluorocarbons, perfluorocarbons, and sulfur hexafluoride. Emission standards apply as follows for greenhouse gas emissions:

(i) CO<sub>2</sub> emission standards apply as described in §§ 1037.105 and 1037.106. No CH<sub>4</sub> or N<sub>2</sub>O standards apply under this part. See 40 CFR part 1036 for CH<sub>4</sub> or N<sub>2</sub>O standards that apply to engines used in these vehicles.

(ii) Hydrofluorocarbon standards apply as described in § 1037.115(e). These pollutants are also “greenhouse

gas pollutants” but are treated separately from exhaust greenhouse gas pollutants listed in paragraph (a)(2)(i) of this section.

(3) *Fuel evaporative and refueling emissions.* Requirements related to fuel evaporative and refueling emissions are described in § 1037.103.

(b) The regulated heavy-duty vehicles are addressed in different groups as follows:

(1) For criteria pollutants, vehicles are regulated based on gross vehicle weight rating (GVWR), whether they are considered “spark-ignition” or “compression-ignition,” and whether they are first sold as complete or incomplete vehicles.

(2) Greenhouse gas standards apply differently for vocational vehicles and tractors. Greenhouse gas standards also apply differently depending on the vehicle service class as described in § 1037.140. In addition, standards apply differently for vehicles with spark-ignition and compression-ignition engines. References in this part to “spark-ignition” or “compression-ignition” generally relate to the application of standards under 40 CFR 1036.140. For example, a vehicle with an engine certified to spark-ignition standards under 40 CFR part 1036 is generally subject to requirements under this part that apply for spark-ignition vehicles. However, note that emission standards for Heavy HDE are considered to be compression-ignition standards for purposes of applying vehicle emission standards under this part. Also, for spark-ignition engines voluntarily certified as compression-ignition engines under 40 CFR part 1036, you must choose at certification whether your vehicles are subject to spark-ignition standards or compression-ignition standards. Heavy-duty vehicles with no installed propulsion engine,

such as battery electric vehicles, are subject to compression-ignition emission standards under §§ 1037.105 and 1037.106 for the purpose of calculating emission credits.

(3) For evaporative and refueling emissions, vehicles are regulated based on the type of fuel they use. Vehicles fueled with volatile liquid fuels or gaseous fuels are subject to evaporative and refueling emission standards.

■ 53. Amend § 1037.102 by revising the section heading and paragraph (b) introductory text to read as follows:

**§ 1037.102 Criteria exhaust emission standards—NO<sub>x</sub>, HC, PM, and CO.**

\* \* \* \* \*

(b) Heavy-duty vehicles with no installed propulsion engine, such as battery electric vehicles, are subject to criteria pollutant standards under this part. The emission standards that apply are the same as the standards that apply for compression-ignition engines under 40 CFR 86.007–11 or 1036.104 for a given model year.

\* \* \* \* \*

■ 54. Amend § 1037.103 by revising paragraph (e) introductory text to read as follows:

**§ 1037.103 Evaporative and refueling emission standards.**

\* \* \* \* \*

(e) *LNG refueling requirement.* Fuel tanks for liquefied natural gas vehicles must meet the hold-time requirements in Section 4.2 of SAE J2343 (incorporated by reference, see § 1037.810), as modified by this paragraph (e). All pressures noted are gauge pressure. Vehicles with tanks meeting the requirements in this paragraph (e) are deemed to comply with evaporative and refueling emission standards. The provisions of this

paragraph (e) are optional for vehicles produced before January 1, 2020. The hold-time requirements of SAE J2343 apply, with the following clarifications and additions:

\* \* \* \* \*

**§ 1037.104 [Removed]**

■ 55. Remove § 1037.104.

■ 56. Revise and republish § 1037.105 to read as follows:

**§ 1037.105 CO<sub>2</sub> emission standards for vocational vehicles.**

(a) The standards of this section apply for the following vehicles:

(1) Heavy-duty vehicles at or below 14,000 pounds GVWR that are not subject to the greenhouse gas standards in 40 CFR part 86, subpart S, or that use engines certified under § 1037.150(m).

(2) Vehicles above 14,000 pounds GVWR and at or below 26,000 pounds GVWR, but not certified to the vehicle greenhouse gas standards in 40 CFR part 86, subpart S.

(3) Vehicles above 26,000 pounds GVWR that are not tractors.

(4) Vocational tractors.

(b) CO<sub>2</sub> standards in this paragraph (b) apply based on modeling and testing as specified in subpart F of this part. The provisions of § 1037.241 specify how to comply with the standards in this paragraph (b). Standards differ based on engine cycle, vehicle size, and intended vehicle duty cycle. See § 1037.510(c) to determine which duty cycle applies. Note that § 1037.230 describes how to divide vehicles into subcategories.

(1) Except as specified in paragraph (b)(2) of this section, model year 2027 and later vehicles are subject to Phase 3 CO<sub>2</sub> standards corresponding to the selected subcategories as shown in the following table:

TABLE 1 OF PARAGRAPH (b)(1) OF § 1037.105—PHASE 3 CO<sub>2</sub> STANDARDS FOR MODEL YEAR 2027 AND LATER VOCATIONAL VEHICLES

Model year	Roof height	CO <sub>2</sub> standard by regulatory subcategory (g/ton·mile)			
		Class 7 all cab styles	Class 8 day cab	Class 8 sleeper cab	Heavy-haul
2027	Low Roof	96.2	73.4	64.1	48.3
	Mid Roof	103.4	78.0	69.6	
	High Roof	100.0	75.7	64.3	
2028	Low Roof	88.5	67.5	64.1	48.3
	Mid Roof	95.1	71.8	69.6	
	High Roof	92.0	69.6	64.3	
2029	Low Roof	84.7	64.6	64.1	47.8
	Mid Roof	91.0	68.6	69.6	
	High Roof	88.0	66.6	64.3	
2030	Low Roof	80.8	61.7	60.3	47.8
	Mid Roof	86.9	65.5	65.4	
	High Roof	84.0	63.6	60.4	
2031	Low Roof	69.3	52.8	56.4	46.9

TABLE 1 OF PARAGRAPH (b)(1) OF § 1037.105—PHASE 3 CO<sub>2</sub> STANDARDS FOR MODEL YEAR 2027 AND LATER VOCATIONAL VEHICLES—Continued

Model year	Roof height	CO <sub>2</sub> standard by regulatory subcategory (g/ton-mile)			
		Class 7 all cab styles	Class 8 day cab	Class 8 sleeper cab	Heavy-haul
2032 and Later .....	Mid Roof .....	74.4	56.2	61.2	45.9
	High Roof .....	72.0	54.5	56.6	
	Low Roof .....	57.7	44.0	48.1	
	Mid Roof .....	62.0	46.8	52.2	
	High Roof .....	60.0	45.4	48.2	

(2) Qualifying small manufacturers of model year 2027 and later vehicles may continue to meet Phase 2 CO<sub>2</sub> standards in this paragraph (b)(2) instead of the standards specified in paragraph (b)(1) of this section. If you certify to these Phase 2 CO<sub>2</sub> standards, you may use the averaging provisions of subpart H of this part to demonstrate compliance. You may use other credit provisions of this part only by certifying all vehicle families within a given averaging set to the Phase 3 standards that apply in that model year.

TABLE 2 OF PARAGRAPH (b)(2) OF § 1037.105—SMALL MANUFACTURER PHASE 2 CO<sub>2</sub> STANDARDS FOR MODEL YEAR 2027 AND LATER VOCATIONAL VEHICLES

Engine cycle	Vehicle service class	CO <sub>2</sub> standard by regulatory subcategory (g/ton-mile)		
		Multi-purpose	Regional	Urban
Compression-ignition .....	Light HDV .....	330	291	367
Compression-ignition .....	Medium HDV .....	235	218	258
Compression-ignition .....	Heavy HDV .....	230	189	269
Spark-ignition .....	Light HDV .....	372	319	413
Spark-ignition .....	Medium HDV .....	268	247	297

(3) Model year 2024 through 2026 vehicles are subject to Phase 2 CO<sub>2</sub> standards corresponding to the selected subcategories as shown in the following table:

TABLE 3 OF PARAGRAPH (b)(3) OF § 1037.105—PHASE 2 CO<sub>2</sub> STANDARDS FOR MODEL YEAR 2024 THROUGH 2026 VOCATIONAL VEHICLES

Engine cycle	Vehicle service class	CO <sub>2</sub> standard by regulatory subcategory (g/ton-mile)		
		Multi-purpose	Regional	Urban
Compression-ignition .....	Light HDV .....	344	296	385
Compression-ignition .....	Medium HDV .....	246	221	271
Compression-ignition .....	Heavy HDV .....	242	194	283
Spark-ignition .....	Light HDV .....	385	324	432
Spark-ignition .....	Medium HDV .....	279	251	310

(4) Model year 2021 through 2023 vehicles are subject to Phase 2 CO<sub>2</sub> standards corresponding to the selected subcategories as shown in the following table:

TABLE 4 OF PARAGRAPH (b)(4) OF § 1037.105—PHASE 2 CO<sub>2</sub> STANDARDS FOR MODEL YEAR 2021 THROUGH 2023 VOCATIONAL VEHICLES

Engine cycle	Vehicle service class	CO <sub>2</sub> standard by regulatory subcategory (g/ton-mile)		
		Multi-purpose	Regional	Urban
Compression-ignition .....	Light HDV .....	373	311	424
Compression-ignition .....	Medium HDV .....	265	234	296
Compression-ignition .....	Heavy HDV .....	261	205	308
Spark-ignition .....	Light HDV .....	407	335	461

TABLE 4 OF PARAGRAPH (b)(4) OF § 1037.105—PHASE 2 CO<sub>2</sub> STANDARDS FOR MODEL YEAR 2021 THROUGH 2023 VOCATIONAL VEHICLES—Continued

Engine cycle	Vehicle service class	CO <sub>2</sub> standard by regulatory subcategory (g/ton-mile)		
		Multi-purpose	Regional	Urban
Spark-ignition .....	Medium HDV .....	293	261	328

(5) Model year 2014 through 2020 vehicles are subject to Phase 1 CO<sub>2</sub> standards as shown in the following table:

TABLE 5 OF PARAGRAPH (b)(5) OF § 1037.105—PHASE 1 CO<sub>2</sub> STANDARDS FOR MODEL YEAR 2014 THROUGH 2020 VOCATIONAL VEHICLES [g/ton-mile]

Vehicle size	CO <sub>2</sub> standard for model years 2014–2016	CO <sub>2</sub> standard for model year 2017–2020
Light HDV .....	388	373
Medium HDV .....	234	225
Heavy HDV .....	226	222

(c) [Reserved]

(d) You may generate or use emission credits for averaging, banking, and trading to demonstrate compliance with the standards in paragraph (b) of this section as described in subpart H of this part. This requires that you specify a Family Emission Limit (FEL) for CO<sub>2</sub> for each vehicle subfamily. The FEL may not be less than the result of emission modeling from § 1037.520. These FELs serve as the emission standards for the vehicle subfamily instead of the standards specified in paragraph (b) of this section.

(e) The exhaust emission standards of this section apply for the full useful life, expressed in service miles or calendar years, whichever comes first. The following useful life values apply for the standards of this section:

- (1) 150,000 miles or 15 years, whichever comes first, for Light HDV.
- (2) 185,000 miles or 10 years, whichever comes first, for Medium HDV.
- (3) 435,000 miles or 10 years, whichever comes first, for Heavy HDV.

(f) See § 1037.631 for provisions that exempt certain vehicles used in off-road operation from the standards of this section.

(g) You may optionally certify a vocational vehicle to the standards and useful life applicable to a heavier

vehicle service class (such as Medium HDV instead of Light HDV). Provisions related to generating emission credits apply as follows:

(1) If you certify all your vehicles from a given vehicle service class in a given model year to the standards and useful life that applies for a heavier vehicle service class, you may generate credits as appropriate for the heavier service class.

(2) Class 8 hybrid vehicles with Light HDE or Medium HDE may be certified to compression-ignition standards for the Heavy HDV service class. You may generate and use credits as allowed for the Heavy HDV service class.

(3) Except as specified in paragraphs (g)(1) and (2) of this section, you may not generate credits with the vehicle. If you include lighter vehicles in a subfamily of heavier vehicles with an FEL below the standard, exclude the production volume of lighter vehicles from the credit calculation. Conversely, if you include lighter vehicles in a subfamily with an FEL above the standard, you must include the production volume of lighter vehicles in the credit calculation.

(h) You may optionally certify certain vocational vehicles to alternative standards as specified in this paragraph (h) instead of the standards specified in paragraph (b) of this section. You may

apply the provisions in this paragraph (h) to any qualifying vehicles even though these standards were established for custom-chassis vehicles. For example, large, diversified vehicle manufacturers may certify vehicles to the refuse hauler standards of this section as long as the manufacturer ensures that those vehicles qualify as refuse haulers when placed into service. GEM simulates vehicle operation for each type of vehicle based on an assigned vehicle service class, independent of the vehicle's actual characteristics, as specified in § 1037.140(g)(7); however, standards apply for the vehicle's useful life based on its actual characteristics as specified in paragraph (e) of this section. Vehicles certified to the standards in this paragraph (h) must include the following statement on the emission control label: "THIS VEHICLE WAS CERTIFIED AS A [identify vehicle type as identified in this section] UNDER 40 CFR 1037.105(h)." These custom-chassis provisions apply as follows:

(1) The following alternative emission standards apply by vehicle type and model year as follows:

(i) Except as specified in paragraph (h)(1)(ii) of this section, CO<sub>2</sub> standards apply for model year 2021 and later custom-chassis vehicles as shown in the following tables:

TABLE 6 OF PARAGRAPH (h)(1)(i) OF § 1037.105—CUSTOM-CHASSIS STANDARDS SCHOOL BUSES, OTHER BUSES, AND REFUSE HAULERS

Phase	Model year	CO <sub>2</sub> standard by custom-chassis vehicle type (g/ton-mile)		
		School bus	Other bus	Refuse hauler
2	2021–2026	291	300	313
3	2027	236	286	298
	2028	228	286	283
	2029	220	249	268
	2030	211	243	253
	2031	187	220	250
	2032 and later	163	200	250

TABLE 7 OF PARAGRAPH (h)(1)(i) OF § 1037.105—CUSTOM-CHASSIS STANDARDS FOR MOTOR HOMES, COACH BUSES, CONCRETE MIXERS, MIXED-USE VEHICLES, AND EMERGENCY VEHICLES

Phase	Model year	CO <sub>2</sub> standard by custom-chassis vehicle type (g/ton-mile)				
		Motor home	Coach bus	Concrete mixer	Mixed-use vehicle	Emergency vehicle
2	2021–2026	228	210	319	319	324
3	2027 and later	226	205	316	316	319

(ii) For qualifying small manufacturers, Phase 2 CO<sub>2</sub> standards apply for model year 2027 and later custom-chassis vehicles instead of the standards specified in paragraph (h)(1)(i) of this section.

TABLE 8 OF PARAGRAPH (h)(1)(ii) OF § 1037.105—SMALL MANUFACTURER PHASE 2 CO<sub>2</sub> STANDARDS FOR MODEL YEAR 2027 AND LATER CUSTOM-CHASSIS VOCATIONAL VEHICLES [g/ton-mile]

Vehicle type	CO <sub>2</sub> standard
School bus	271
Motor home	226
Coach bus	205
Other bus	286
Refuse hauler	298
Concrete mixer	316
Mixed-use vehicle	316
Emergency vehicle	319

(iii) Vehicle types identified in this paragraph (h)(1) are generally defined in § 1037.801. “Other bus” includes any bus that is not a school bus or a coach bus. A “mixed-use vehicle” is one that meets at least one of the criteria specified in § 1037.631(a)(1) or (2).

(2) You may generate or use emission credits for averaging to demonstrate compliance with the alternative standards as described in subpart H of this part. This requires that you specify a Family Emission Limit (FEL) for CO<sub>2</sub> for each vehicle subfamily. The FEL may not be less than the result of emission modeling as described in § 1037.520. These FELs serve as the emission standards for the vehicle subfamily instead of the standards specified in this paragraph (h). Calculate credits using the equation in § 1037.705(b) with the standard payload

for the assigned vehicle service class and the useful life identified in paragraph (e) of this section. Each separate vehicle type identified in paragraph (h)(1) of this section (or group of vehicle types identified in a single row) represents a separate averaging set. You may not use averaging for vehicles meeting standards under paragraphs (h)(5) through (7) of this section, and you may not bank or trade emission credits from any vehicles certified under this paragraph (h).

(3) [Reserved]

(4) For purposes of emission modeling under § 1037.520, consider motor homes and coach buses to be subject to the Regional duty cycle, and consider all other vehicles to be subject to the Urban duty cycle.

(5) Emergency vehicles are deemed to comply with the standards of this

paragraph (h) if they use tires with TRRL at or below 8.4 N/kN (8.7 N/kN for model years 2021 through 2026).

(6) Concrete mixers and mixed-use vehicles are deemed to comply with the standards of this paragraph (h) if they use tires with TRRL at or below 7.1 N/kN (7.6 N/kN for model years 2021 through 2026).

(7) Motor homes are deemed to comply with the standards of this paragraph (h) if they have tires with TRRL at or below 6.0 N/kN (6.7 N/kN for model years 2021 through 2026) and automatic tire inflation systems or tire pressure monitoring systems with wheels on all axles.

(8) Vehicles certified to standards under this paragraph (h) must use engines certified under 40 CFR part 1036 for the appropriate model year, except that motor homes and emergency

vehicles may use engines certified with the loose-engine provisions of § 1037.150(m). This paragraph (h)(8) also applies for vehicles meeting standards under paragraphs (h)(5) through (7) of this section.

■ 57. Amend § 1037.106 by:

■ a. Revising the section heading and paragraph (b);

■ b. Removing and reserving paragraph (c); and

■ c. Revising paragraph (f)(2).

The revisions read as follows:

**§ 1037.106 CO<sub>2</sub> emission standards for tractors above 26,000 pounds GVWR.**

\* \* \* \* \*

(b) CO<sub>2</sub> standards in this paragraph (b) apply based on modeling and testing as described in subpart F of this part. The

provisions of § 1037.241 specify how to comply with the standards in this paragraph (b). Note that § 1037.230 describes how to divide vehicles into subcategories.

(1) Except as specified in paragraph (b)(2) of this section, model year 2027 and later tractors are subject to Phase 3 CO<sub>2</sub> standards corresponding to the selected subcategories as shown in the following table:

**TABLE 1 OF PARAGRAPH (b)(1) OF § 1037.106—PHASE 3 CO<sub>2</sub> STANDARDS FOR MODEL YEAR 2027 AND LATER TRACTORS**

Model year	Roof height	CO <sub>2</sub> standard by regulatory subcategory (g/ton-mile)			
		Class 7 all cab styles	Class 8 day cab	Class 8 sleeper cab	Heavy-haul
2027	Low Roof	96.2	73.4	64.1	48.3
	Mid Roof	103.4	78.0	69.6	
	High Roof	100.0	75.7	64.3	
2028	Low Roof	88.5	67.5	64.1	48.3
	Mid Roof	95.1	71.8	69.6	
	High Roof	92.0	69.6	64.3	
2029	Low Roof	84.7	64.6	64.1	47.8
	Mid Roof	91.0	68.6	69.6	
	High Roof	88.0	66.6	64.3	
2030	Low Roof	80.8	61.7	60.3	47.8
	Mid Roof	86.9	65.5	65.4	
	High Roof	84.0	63.6	60.4	
2031	Low Roof	69.3	52.8	56.4	46.9
	Mid Roof	74.4	56.2	61.2	
	High Roof	72.0	54.5	56.6	
2032 and Later	Low Roof	57.7	44.0	48.1	45.9
	Mid Roof	62.0	46.8	52.2	
	High Roof	60.0	45.4	48.2	

(2) Qualifying small manufacturers of model year 2027 and later vehicles may continue to meet Phase 2 CO<sub>2</sub> standards in this paragraph (b)(2) instead of the standards specified in paragraph (b)(1)

of this section. If you certify to these Phase 2 CO<sub>2</sub> standards, you may use the averaging provisions of subpart H of this part to demonstrate compliance. You may use other credit provisions of this

part only by certifying all vehicle families within a given averaging set to the Phase 3 standards that apply in that model year.

**TABLE 2 OF PARAGRAPH (b)(2) OF § 1037.106—SMALL MANUFACTURER CO<sub>2</sub> STANDARDS FOR MODEL YEAR 2027 AND LATER TRACTORS**

Subcategory	Phase 2 CO <sub>2</sub> standards (g/ton-mile)
Class 7 Low-Roof (all cab styles)	96.2
Class 7 Mid-Roof (all cab styles)	103.4
Class 7 High-Roof (all cab styles)	100.0
Class 8 Low-Roof Day Cab	73.4
Class 8 Low-Roof Sleeper Cab	64.1
Class 8 Mid-Roof Day Cab	78.0
Class 8 Mid-Roof Sleeper Cab	69.6
Class 8 High-Roof Day Cab	75.7
Class 8 High-Roof Sleeper Cab	64.3
Heavy-Haul Tractors	48.3

(3) Model year 2026 and earlier tractors are subject to CO<sub>2</sub> standards corresponding to the selected

subcategory as shown in the following table:

TABLE 3 OF PARAGRAPH (b)(3) OF § 1037.106—CO<sub>2</sub> STANDARDS FOR MODEL YEAR 2026 AND EARLIER TRACTORS [g/ton-mile]

Subcategory	Phase 1 standards for model years 2014–2016	Phase 1 standards for model years 2017–2020	Phase 2 standards for model years 2021–2023	Phase 2 standards for model years 2024–2026
Class 7 Low-Roof (all cab styles)	107	104	105.5	99.8
Class 7 Mid-Roof (all cab styles)	119	115	113.2	107.1
Class 7 High-Roof (all cab styles)	124	120	113.5	106.6
Class 8 Low-Roof Day Cab	81	80	80.5	76.2
Class 8 Low-Roof Sleeper Cab	68	66	72.3	68.0
Class 8 Mid-Roof Day Cab	88	86	85.4	80.9
Class 8 Mid-Roof Sleeper Cab	76	73	78.0	73.5
Class 8 High-Roof Day Cab	92	89	85.6	80.4
Class 8 High-Roof Sleeper Cab	75	72	75.7	70.7
Heavy-Haul Tractors			52.4	50.2

\* \* \* \* \*

(f) \* \* \*  
 (2) You may optionally certify Class 7 tractors not covered by paragraph (f)(1) of this section to the standards and useful life for Class 8 tractors. This paragraph (f)(2) applies equally for hybrid vehicles, battery electric vehicles, and fuel cell electric vehicles. Credit provisions apply as follows:

(i) If you certify all your Class 7 tractors to Class 8 standards, you may use these Heavy HDV credits without restriction.

(ii) This paragraph (f)(2)(ii) applies if you certify some Class 7 tractors to Class 8 standards under this paragraph (f)(2) but not all of them. If you include Class 7 tractors in a subfamily of Class 8 tractors with an FEL below the standard, exclude the production volume of Class 7 tractors from the credit calculation. Conversely, if you include Class 7 tractors in a subfamily of Class 8 tractors with an FEL above the standard, you must include the production volume of Class 7 tractors in the credit calculation.

\* \* \* \* \*

**§ 1037.107 [Removed]**

■ 58. Remove § 1037.107.

■ 59. Amend § 1037.115 by revising paragraphs (a) and (e)(1) and adding paragraph (f) to read as follows:

**§ 1037.115 Other requirements.**

\* \* \* \* \*

(a) *Adjustable parameters.* Vehicles that have adjustable parameters must meet all the requirements of this part for any adjustment in the practically adjustable range. We may require that you set adjustable parameters to any specification within the practically adjustable range during any testing. See 40 CFR 1068.50 for general provisions related to adjustable parameters. You must ensure safe vehicle operation throughout the practically adjustable range of each adjustable parameter, including consideration of production tolerances. Note that adjustable roof fairings are deemed not to be adjustable parameters.

\* \* \* \* \*

(e) \* \* \*  
 (1) This paragraph (e) is intended to address air conditioning systems for which the primary purpose is to cool the driver compartment. This would generally include all cab-complete pickups and vans. Similarly, it does not

apply for self-contained air conditioning used to cool passengers or refrigeration units used to cool cargo on vocational vehicles. For purposes of this paragraph (e), a self-contained system is an enclosed unit with its own evaporator and condenser even if it draws power from the engine.

\* \* \* \* \*

(f) *Battery durability monitor.* Model year 2030 and later battery electric vehicles and plug-in hybrid electric vehicles must meet the following requirements to estimate and monitor usable battery energy for batteries serving as Rechargeable Energy Storage Systems:

(1) Create a customer-accessible system that monitors and displays the vehicle’s State of Certified Energy (SOCE) with an accuracy of ±5%. Display the SOCE from paragraph (f)(2) of this section as a percentage expressed to the nearest whole number. Update the display as needed to reflect the current value of SOCE.

(2) Determine SOCE using the following equation:

$$SOCE = \frac{UBE_{aged}}{UBE_{certified}} = \frac{\left(\int_0^{end} V(t)I(t)dt\right)_{aged}}{\left(\int_0^{end} V(t)I(t)dt\right)_{certified}}$$

Eq. 1037.115–1

Where:

UBE = usable battery energy as determined in paragraph (f)(3) or (4) of this section, where certified refers to the value established for certification and aged refers to the current value as the battery ages.

V = battery voltage.

t = the time for the test, running from time zero to the end point when the battery is not able to maintain the target power. I = battery current.

(3) For battery electric vehicles, ask us to approve a procedure you develop to determine UBE that meets the following requirements:

(i) Measure UBE by discharging the battery at a constant power that is

representative of the vehicle cruising on the highway. For many HDV, the power to cruise on the highway would result in a C-rate between 1/6 C and 1/2 C. Where C-rate is a measure of the rate at which a battery is discharged or charged relative to its maximum capacity and has units of inverse hours. For example, at a 2 C discharge rate, it would take 0.5 hours to fully discharge a battery. For

test procedures that involve driving a vehicle, you may discharge the battery at variable rates until the last portion of the test, consistent with good engineering judgment.

(ii) The test is complete when the battery is not able to maintain the target power.

(iii) Use the same procedure for measuring certified and aged UBE.

(iv) Measurements to determine power must meet the requirements in 40 CFR 1036.545(a)(10).

(4) For plug-hybrid electric vehicles, determine UBE as described in 40 CFR 1036.545(p), or you may use a procedure that meets the requirements of paragraph (f)(3) of this section.

■ 60. Amend § 1037.120 by revising paragraphs (b) and (c) to read as follows:

**§ 1037.120 Emission-related warranty requirements.**

\* \* \* \* \*

(b) *Warranty period.* (1) Your emission-related warranty must be valid for at least:

(i) 5 years or 50,000 miles for Light HDV (except tires).

(ii) 5 years or 100,000 miles for Medium HDV and Heavy HDV (except tires).

(iii) 2 years or 24,000 miles for tires.

(2) You may offer an emission-related warranty more generous than we require. The emission-related warranty for the vehicle may not be shorter than any basic mechanical warranty you provide to that owner without charge for the vehicle. Similarly, the emission-related warranty for any component may not be shorter than any warranty you provide to that owner without charge for that component. This means that your warranty for a given vehicle may not treat emission-related and nonemission-related defects differently for any component. The warranty period begins when the vehicle is placed into service.

(c) *Components covered.* The emission-related warranty covers tires, automatic tire inflation systems, tire pressure monitoring systems, vehicle speed limiters, idle-reduction systems, devices added to the vehicle to improve aerodynamic performance (not including standard components such as hoods or mirrors even if they have been optimized for aerodynamics) to the extent such emission-related components are included in your application for certification. The emission-related warranty similarly covers fuel cell stacks, RESS, and other components used with hybrid systems, battery electric vehicles, and fuel cell electric vehicles. The emission-related warranty also covers other added

emission-related components to the extent they are included in your application for certification, and any other components whose failure would increase a vehicle's CO<sub>2</sub> emissions. The emission-related warranty covers all components whose failure would increase a vehicle's emissions of air conditioning refrigerants (for vehicles subject to air conditioning leakage standards), and it covers all components whose failure would increase a vehicle's evaporative and refueling emissions (for vehicles subject to evaporative and refueling emission standards). The emission-related warranty covers components that are part of your certified configuration even if another company produces the component.

\* \* \* \* \*

■ 61. Amend § 1037.130 by revising paragraph (a) to read as follows:

**§ 1037.130 Assembly instructions for secondary vehicle manufacturers.**

(a) If you sell a certified incomplete vehicle to a secondary vehicle manufacturer, give the secondary vehicle manufacturer instructions for completing vehicle assembly consistent with the requirements of this part. Include all information necessary to ensure that the final vehicle assembly (including the engine) will be in its certified configuration.

\* \* \* \* \*

■ 62. Amend § 1037.135 by revising paragraph (c)(6) to read as follows:

**§ 1037.135 Labeling.**

\* \* \* \* \*

(c) \* \* \*

(6) For Phase 1 vehicles, identify the emission control system. Use terms and abbreviations as described in appendix C to this part or other applicable conventions.

\* \* \* \* \*

■ 63. Amend § 1037.140 by revising paragraphs (c) and (g) to read as follows:

**§ 1037.140 Classifying vehicles and determining vehicle parameters.**

\* \* \* \* \*

(c) Base a standard trailer's length on the outer dimensions of the load-carrying structure. Do not include aerodynamic devices or HVAC units.

\* \* \* \* \*

(g) The standards and other provisions of this part apply to specific vehicle service classes as follows:

(1) Tractors are divided based on GVWR into Class 7 tractors and Class 8 tractors. Where provisions of this part apply to both tractors and vocational vehicles, Class 7 tractors are considered "Medium HDV" and Class 8 tractors are

considered "Heavy HDV". This paragraph (g)(1) applies for hybrid and non-hybrid vehicles.

(2) Phase 1 vocational vehicles are divided based on GVWR. "Light HDV" includes Class 2b through Class 5 vehicles; "Medium HDV" includes Class 6 and Class 7 vehicles; and "Heavy HDV" includes Class 8 vehicles.

(3) Phase 2 and later vocational vehicles propelled by engines subject to the spark-ignition standards of 40 CFR part 1036 are divided as follows:

(i) Class 2b through Class 5 vehicles are considered "Light HDV".

(ii) Class 6 through Class 8 vehicles are considered "Medium HDV".

(4) Phase 2 and later vocational vehicles propelled by engines subject to the compression-ignition standards in 40 CFR part 1036 are divided as follows:

(i) Class 2b through Class 5 vehicles are considered "Light HDV".

(ii) Class 6 through 8 vehicles are considered "Heavy HDV" if the installed engine's primary intended service class is Heavy HDE (see 40 CFR 1036.140), except that Class 8 hybrid vehicles are considered "Heavy HDV" regardless of the engine's primary intended service class.

(iii) All other Class 6 through Class 8 vehicles are considered "Medium HDV".

(5) Heavy-duty vehicles with no installed propulsion engine, such as battery electric vehicles, are divided as follows:

(i) Class 2b through Class 5 vehicles are considered "Light HDV".

(ii) Class 6 and 7 vehicles are considered "Medium HDV".

(iii) Class 8 vehicles are considered "Heavy HDV".

(6) In certain circumstances, you may certify vehicles to standards that apply for a different vehicle service class. For example, see §§ 1037.105(g) and 1037.106(f). If you optionally certify vehicles to different standards, those vehicles are subject to all the regulatory requirements as if the standards were mandatory.

(7) Vehicles meeting the custom-chassis standards of § 1037.105(h)(1) are subject to the following vehicle service classes instead of the other provisions in this section:

(i) School buses and motor homes are considered "Medium HDV".

(ii) All other custom-chassis are considered "Heavy HDV".

\* \* \* \* \*

■ 64. Revise and republish § 1037.150 to read as follows:

**§ 1037.150 Interim provisions.**

The provisions in this section apply instead of other provisions in this part.



(a) *Incentives for early introduction.* The provisions of this paragraph (a) apply with respect to vehicles produced in model years before 2014.

Manufacturers may voluntarily certify in model year 2013 (or earlier model years for electric vehicles) to the greenhouse gas standards of this part.

(1) This paragraph (a)(1) applies for regulatory subcategories subject to the standards of § 1037.105 or § 1037.106. Except as specified in paragraph (a)(3) of this section, to generate early credits under this paragraph (a)(1) for any vehicles other than electric vehicles, you must certify your entire U.S.-directed production volume within the regulatory subcategory to the standards of § 1037.105 or § 1037.106. Except as specified in paragraph (a)(4) of this section, if some vehicle families within a regulatory subcategory are certified after the start of the model year, you may generate credits only for production that occurs after all families are certified. For example, if you produce three vehicle families in an averaging set and you receive your certificates for those families on January 4, 2013, March 15, 2013, and April 24, 2013, you may not generate credits for model year 2013 production in any of the families that occurs before April 24, 2013. Calculate credits relative to the standard that would apply in model year 2014 using the equations in subpart H of this part. You may bank credits equal to the surplus credits you generate under this paragraph (a) multiplied by 1.50. For example, if you have 1.0 Mg of surplus credits for model year 2013, you may bank 1.5 Mg of credits. Credit deficits for an averaging set prior to model year 2014 do not carry over to model year 2014. These credits may be used to show compliance with the standards of this part for 2014 and later model years. We recommend that you notify EPA of your intent to use this paragraph (a)(1) before submitting your applications.

(2) [Reserved]

(3) You may generate emission credits for the number of additional SmartWay designated tractors (relative to your 2012 production), provided you do not generate credits for those vehicles under paragraph (a)(1) of this section. Calculate credits for each regulatory subcategory relative to the standard that would apply in model year 2014 using the equations in subpart H of this part. Use a production volume equal to the number of designated model year 2013 SmartWay tractors minus the number of designated model year 2012 SmartWay tractors. You may bank credits equal to the surplus credits you generate under this paragraph (a)(3) multiplied by 1.50.

Your 2012 and 2013 model years must be equivalent in length.

(4) This paragraph (a)(4) applies where you do not receive your final certificate in a regulatory subcategory within 30 days of submitting your final application for that subcategory. Calculate your credits for all production that occurs 30 days or more after you submit your final application for the subcategory.

(b) *Phase 1 coastdown procedures.* For tractors subject to Phase 1 standards under § 1037.106, the default method for measuring drag area ( $C_dA$ ) is the coastdown procedure specified in 40 CFR part 1066, subpart D. This includes preparing the tractor and the standard trailer with wheels meeting specifications of § 1037.528(b) and submitting information related to your coastdown testing under § 1037.528(h).

(c) *Small manufacturers.* The following provisions apply for qualifying small manufacturers:

(1) The greenhouse gas standards of §§ 1037.105 and 1037.106 are optional for small manufacturers producing vehicles with a date of manufacture before January 1, 2022. In addition, small manufacturers producing vehicles that run on any fuel other than gasoline, E85, or diesel fuel may delay complying with every later standard under this part by one model year.

(2) Qualifying manufacturers must notify the Designated Compliance Officer each model year before introducing excluded vehicles into U.S. commerce. This notification must include a description of the manufacturer's qualification as a small business under 13 CFR 121.201. Manufacturers must label excluded vehicles with the following statement: "THIS VEHICLE IS EXCLUDED UNDER 40 CFR 1037.150(c)."

(3) Small manufacturers may meet Phase 1 standards instead of Phase 2 standards in the first year Phase 2 standards apply to them if they voluntarily comply with the Phase 1 standards for the full preceding year. Specifically, small manufacturers may certify their model year 2022 vehicles to the Phase 1 greenhouse gas standards of §§ 1037.105 and 1037.106 if they certify all the vehicles from their annual production volume included in emission credit calculations for the Phase 1 standards starting on or before January 1, 2021.

(4) See paragraphs (r), (t), (u), and (w) of this section for additional allowances for small manufacturers.

(d) *Air conditioning leakage for vocational vehicles.* The air conditioning leakage standard of § 1037.115 does not apply for model

year 2020 and earlier vocational vehicles.

(e) *Delegated assembly.* The delegated-assembly provisions of § 1037.621 do not apply before January 1, 2018.

(f) *Testing exemption for qualifying vehicles.* Tailpipe CO<sub>2</sub> emissions from battery electric vehicles, fuel cell electric vehicles, and vehicles with engines fueled with neat hydrogen are deemed to be zero. No CO<sub>2</sub>-related testing is required under this part for these vehicles.

(g) *Compliance date.* Compliance with the standards of this part was optional prior to January 1, 2014. This means that if your 2014 model year begins before January 1, 2014, you may certify for a partial model year that begins on January 1, 2014, and ends on the day your model year would normally end. You must label model year 2014 vehicles excluded under this paragraph (g) with the following statement: "THIS VEHICLE IS EXCLUDED UNDER 40 CFR 1037.150(g)."

(h) *Off-road vehicle exemption.* (1) Vocational vehicles with a date of manufacture before January 1, 2021, automatically qualify for an exemption under § 1037.631 if the tires installed on the vehicle have a maximum speed rating at or below 55 miles per hour.

(2) In unusual circumstances, vehicle manufacturers may ask us to exempt vehicles under § 1037.631 based on other criteria that are equivalent to those specified in § 1037.631(a); however, we will normally not grant relief in cases where the vehicle manufacturer has credits or can otherwise comply with applicable standards. Request approval for an exemption under this paragraph (h) before you produce the subject vehicles. Send your request with supporting information to the Designated Compliance Officer; we will coordinate with NHTSA in making a determination under § 1037.210. If you introduce into U.S. commerce vehicles that depend on our approval under this paragraph (h) before we inform you of our approval, those vehicles violate 40 CFR 1068.101(a)(1).

(i) *Limited carryover from Phase 1 to Phase 2.* The provisions for carryover data in § 1037.235(d) do not allow you to use aerodynamic test results from Phase 1 to support a compliance demonstration for Phase 2 certification.

(j) *Limited prohibition related to early model year engines.* The provisions of this paragraph (j) apply only for vehicles that have a date of manufacture before January 1, 2018. See § 1037.635 for related provisions that apply in later model years. The prohibition in § 1037.601 against introducing into U.S.

commerce a vehicle containing an engine not certified to the standards applicable for the calendar year of installation does not apply for vehicles using model year 2014 or 2015 spark-ignition engines, or any model year 2013 or earlier engines.

(k) *Verifying drag areas from in-use tractors.* This paragraph (k) applies for tractors instead of § 1037.401(b) through model year 2020. We may measure the drag area of your vehicles after they have been placed into service. To account for measurement variability, your vehicle is deemed to conform to the regulations of this part with respect to aerodynamic performance if we measure its drag area to be at or below the maximum drag area allowed for the bin above the bin to which you certified (for example, Bin II if you certified the vehicle to Bin III), unless we determine that you knowingly produced the vehicle to have a higher drag area than is allowed for the bin to which it was certified.

(l) *Optional certification to GHG standards under 40 CFR part 86.* The greenhouse gas standards in 40 CFR part 86, subpart S, may apply instead of the standards of § 1037.105 as follows:

(1) Complete or cab-complete vehicles may optionally meet alternative standards as described in 40 CFR 86.1819–14(j).

(2) Complete high-GCWR vehicles must meet the greenhouse gas standards of 40 CFR part 86, subpart S, as described in 40 CFR 1036.635.

(3) Incomplete high-GCWR vehicles may meet the greenhouse gas standards of 40 CFR part 86, subpart S, as described in 40 CFR 1036.635.

(m) *Loose engine sales.* Manufacturers may certify certain spark-ignition engines along with chassis-certified heavy-duty vehicles where they are identical to engines used in those vehicles as described in 40 CFR 86.1819–14(k)(8). Vehicles in which those engines are installed are subject to standards under this part as specified in § 1037.105.

(n) *Transition to engine-based model years.* The following provisions apply for production and ABT reports during the transition to engine-based model year determinations for vehicles in 2020 and 2021:

(1) If you install model year 2020 or earlier engines in your vehicles in calendar year 2020, include all those Phase 1 vehicles in your production and ABT reports related to model year 2020 compliance, although we may require you identify these separately from vehicles produced in calendar year 2019.

(2) If you install model year 2020 engines in your vehicles in calendar year 2021, submit production and ABT reports for those Phase 1 vehicles separate from the reports you submit for Phase 2 vehicles with model year 2021 engines.

(o) *Interim useful life for light heavy-duty vocational vehicles.* Class 2b through Class 5 vocational vehicles certified to Phase 1 standards are subject to a useful life of 110,000 miles or 10 years, whichever comes first, instead of the useful life specified in § 1037.105. For emission credits generated from these Phase 1 vehicles, multiply any banked credits that you carry forward to demonstrate compliance with Phase 2 standards by 1.36.

(p) *Credit multiplier for advanced technology.* The following provisions describe how you may generate and use credits from vehicles certified with advanced technology:

(1) You may calculate credits you generate from vehicles certified with advanced technology as follows:

(i) For Phase 1 vehicles, multiply the credits by 1.50, except that you may not apply this multiplier in addition to the early-credit multiplier of paragraph (a) of this section.

(ii) For model year 2026 and earlier Phase 2 vehicles, apply multipliers of 3.5 for plug-in hybrid electric vehicles, 4.5 for battery electric vehicles, and 5.5 for fuel cell electric vehicles. Calculate credits relative to the Phase 2 standard.

(iii) For Phase 3 vehicles, the advanced-technology multipliers described in paragraph (p)(1)(ii) of this section apply only in model year 2027. Calculate credits relative to the Phase 3 standard.

(2) You may use credit quantities described in paragraphs (p)(1)(i) and (ii) of this section through model year 2026. The following provisions apply for advanced technology credits starting in model year 2027:

(i) Quantify accumulated credit balances in each model year that result from multiplier credit values. For example, if BEV earns 100 Mg of CO<sub>2</sub> credits that become 450 Mg of credits when multiplied, the base credit value is 100 Mg and the multiplier credit value is 350 Mg. Provide a detailed accounting of base and multiplier credits in your annual ABT reports for the relevant model years.

(ii) For each vehicle family, calculate a credit quantity with no consideration of credit multipliers. Sum these credit quantities for every family within a given averaging set.

(iii) Apply available credits in the following priority order as long as the summed credit quantity is negative.

(A) Base credits banked or traded within the same averaging set.

(B) Base credits earned in the same model year from other averaging sets as specified in paragraph (z) of this section.

(C) Base credits from other averaging sets as specified in paragraph (z) of this section that are banked or traded.

(D) Multiplier credits within the same averaging set for the same model year.

(E) Multiplier credits banked or traded within the same averaging set.

(F) Multiplier credits earned in the same model year from other averaging sets as specified in paragraph (z) of this section.

(G) Multiplier credits from other averaging sets as specified in paragraph (z) of this section that are banked or traded.

(iv) You may no longer use multiplier credits for certifying model year 2030 and later vehicles.

(v) Credit provisions not addressed in this paragraph (p)(2), such as limitations on credit life and credit trading, continue to apply as specified. Note the following:

(A) Unlike multiplier credits, the life of base credits is not limited under this paragraph (p)(2).

(B) You may apply multiplier credits without the restrictions described in this paragraph (p)(2) to resolve a deficit that remains from complying with Phase 2 standards in model years 2026 and earlier.

(q) *Vehicle families for advanced and off-cycle technologies.* Apply the following provisions for grouping vehicles into families if you use off-cycle technologies under § 1037.610 or advanced technologies under § 1037.615:

(1) For Phase 1 vehicles, create separate vehicle families for vehicles that contain advanced or off-cycle technologies; group those vehicles together in a vehicle family if they use the same advanced or off-cycle technologies.

(2) For Phase 2 and Phase 3 vehicles, create separate vehicle subfamilies for vehicles that contain advanced or off-cycle technologies; group those vehicles together in a vehicle subfamily if they use the same advanced or off-cycle technologies.

(r) *Conversion to mid-roof and high-roof configurations.* Secondary vehicle manufacturers that qualify as small manufacturers may convert low- and mid-roof tractors to mid- and high-roof configurations without recertification for the purpose of building a custom sleeper tractor or converting it to run on natural gas, as follows:

(1) The original low- or mid-roof tractor must be covered by a valid certificate of conformity.

(2) The modifications may not increase the frontal area of the tractor beyond the frontal area of the equivalent mid- or high-roof tractor with the corresponding standard trailer. Note that these dimensions have a tolerance of  $\pm 2$  inches. Use good engineering judgment to achieve aerodynamic performance similar to or better than the certifying manufacturer's corresponding mid- or high-roof tractor.

(3) Add a permanent supplemental label to the vehicle near the original manufacturer's emission control information label. On the label identify your full corporate name and include the following statement: "THIS VEHICLE WAS MODIFIED AS ALLOWED UNDER 40 CFR 1037.150."

(4) We may require that you submit annual production reports as described in § 1037.250.

(5) Modifications made under this paragraph (r) do not violate 40 CFR 1068.101(b)(1).

(s) *Confirmatory testing for  $F_{alt-aero}$ .* If we conduct coastdown testing to verify your  $F_{alt-aero}$  value for Phase 2 and later tractors, we will make our determination using the principles of SEA testing in § 1037.305. We will not replace your  $F_{alt-aero}$  value if the tractor passes. If your tractor fails, we will generate a replacement value of  $F_{alt-aero}$  based on at least one  $C_dA$  value and corresponding effective yaw angle,  $\psi_{eff}$ , from a minimum of 100 valid runs using the procedures of § 1037.528(h). Note that we intend to minimize the differences between our test conditions and those of the manufacturer by testing at similar times of the year where possible and the same location where possible and when appropriate.

(t) *Glider kits and glider vehicles.* (1) Glider vehicles conforming to the requirements in this paragraph (t)(1) are exempt from the Phase 1 emission standards of this part 1037 prior to January 1, 2021. Engines in such vehicles (including vehicles produced after January 1, 2021) remain subject to the requirements of 40 CFR part 86 applicable for the engines' original model year, but not subject to the Phase 1 or Phase 2 standards of 40 CFR part 1036 unless they were originally manufactured in model year 2014 or later.

(i) You are eligible for the exemption in this paragraph (t)(1) if you are a small manufacturer and you sold one or more glider vehicles in 2014 under the provisions of paragraph (c) of this section. You do not qualify if you only produced glider vehicles for your own

use. You must notify us of your plans to use this exemption before you introduce exempt vehicles into U.S. commerce. In your notification, you must identify your annual U.S.-directed production volume (and sales, if different) of such vehicles for calendar years 2010 through 2014. Vehicles you produce before notifying us are not exempt under this section.

(ii) In a given calendar year, you may produce up to 300 exempt vehicles under this section, or up to the highest annual production volume you identify in this paragraph (t)(1), whichever is less.

(iii) Identify the number of exempt vehicles you produced under this exemption for the preceding calendar year in your annual report under § 1037.250.

(iv) Include the appropriate statement on the label required under § 1037.135, as follows:

(A) For Phase 1 vehicles, "THIS VEHICLE AND ITS ENGINE ARE EXEMPT UNDER 40 CFR 1037.150(t)(1)."

(B) For Phase 2 vehicles, "THE ENGINE IN THIS VEHICLE IS EXEMPT UNDER 40 CFR 1037.150(t)(1)."

(v) If you produce your glider vehicle by installing remanufactured or previously used components in a glider kit produced by another manufacturer, you must provide the following to the glider kit manufacturer prior to obtaining the glider kit:

(A) Your name, the name of your company, and contact information.

(B) A signed statement that you are a qualifying small manufacturer and that your production will not exceed the production limits of this paragraph (t)(1). This statement is deemed to be a submission to EPA, and we may require the glider kit manufacturer to provide a copy to us at any time.

(vi) The exemption in this paragraph (t)(1) is valid for a given vehicle and engine only if you meet all the requirements and conditions of this paragraph (t)(1) that apply with respect to that vehicle and engine. Introducing such a vehicle into U.S. commerce without meeting all applicable requirements and conditions violates 40 CFR 1068.101(a)(1).

(vii) Companies that are not small manufacturers may sell uncertified incomplete vehicles without engines to small manufacturers for the purpose of producing exempt vehicles under this paragraph (t)(1), subject to the provisions of § 1037.622. However, such companies must take reasonable steps to ensure that their incomplete vehicles will be used in conformance with the requirements of this part.

(2) Glider vehicles produced using engines certified to model year 2010 or later standards for all pollutants are subject to the same provisions that apply to vehicles using engines within their useful life in § 1037.635.

(3) For calendar year 2017, you may produce a limited number of glider kits and/or glider vehicles subject to the requirements applicable to model year 2016 glider vehicles, instead of the requirements of § 1037.635. The limit applies to your combined 2017 production of glider kits and glider vehicles and is equal to your highest annual production of glider kits and glider vehicles for any year from 2010 to 2014. Any glider kits or glider vehicles produced beyond this cap are subject to the provisions of § 1037.635. Count any glider kits and glider vehicles you produce under paragraph (t)(1) of this section as part of your production with respect to this paragraph (t)(3).

(u) *Transition to Phase 2 standards.* The following provisions allow for enhanced generation and use of emission credits from Phase 1 vehicles for meeting the Phase 2 standards:

(1) For vocational Light HDV and vocational Medium HDV, emission credits you generate in model years 2018 through 2021 may be used through model year 2027, instead of being limited to a five-year credit life as specified in § 1037.740(c). For Class 8 vocational vehicles with Medium HDE, we will approve your request to generate these credits in and use these credits for the Medium HDV averaging set if you show that these vehicles would qualify as Medium HDV under the Phase 2 program as described in § 1037.140(g)(4).

(2) You may use the off-cycle provisions of § 1037.610 to apply technologies to Phase 1 vehicles as follows:

(i) You may apply an improvement factor of 0.988 for vehicles with automatic tire inflation systems on all axles.

(ii) For vocational vehicles with automatic engine shutdown systems that conform with § 1037.660, you may apply an improvement factor of 0.95.

(iii) For vocational vehicles with stop-start systems that conform with § 1037.660, you may apply an improvement factor of 0.92.

(iv) For vocational vehicles with neutral-idle systems conforming with § 1037.660, you may apply an improvement factor of 0.98. You may adjust this improvement factor if we approve a partial reduction under § 1037.660(a)(2); for example, if your design reduces fuel consumption by half

as much as shifting to neutral, you may apply an improvement factor of 0.99.

(3) Small manufacturers may generate emission credits for natural gas-fueled vocational vehicles as follows:

(i) Small manufacturers may certify their vehicles instead of relying on the exemption of paragraph (c) of this section. The provisions of this part apply for such vehicles, except as specified in this paragraph (u)(3).

(ii) Use GEM version 2.0.1 to determine a CO<sub>2</sub> emission level for your vehicle, then multiply this value by the engine's Family Certification Level for CO<sub>2</sub> and divide by the engine's applicable CO<sub>2</sub> emission standard.

(4) Phase 1 vocational vehicle credits that small manufacturers generate may be used through model year 2027.

(v) *Constraints for vocational regulatory subcategories.* The following provisions apply to determinations of vocational regulatory subcategories as described in § 1037.140:

(1) Select the Regional regulatory subcategory for coach buses and motor homes you certify under § 1037.105(b).

(2) You may not select the Urban regulatory subcategory for any vehicle with a manual or single-clutch automated manual transmission.

(3) Starting in model year 2024, you must select the Regional regulatory subcategory for any vehicle with a manual transmission.

(4) You may select the Multi-purpose regulatory subcategory for any vocational vehicle, except as specified in paragraph (v)(1) of this section.

(5) You may select the Urban regulatory subcategory for a hybrid vehicle equipped with regenerative braking, unless it is equipped with a manual transmission.

(6) You may select the Urban regulatory subcategory for any vehicle with a hydrokinetic torque converter paired with an automatic transmission, or a continuously variable automatic transmission, or a dual-clutch transmission with no more than two consecutive forward gears between which it is normal for both clutches to be momentarily disengaged.

(w) *Custom-chassis standards for small manufacturers.* The following provisions apply uniquely to qualifying small manufacturers under the custom-chassis standards of § 1037.105(h):

(1) You may use emission credits generated under § 1037.105(d), including banked or traded credits from any averaging set. Such credits remain subject to other limitations that apply under subpart H of this part.

(2) You may produce up to 200 drayage tractors in a given model year to the standards described in

§ 1037.105(h) for "other buses". The limit in this paragraph (w)(2) applies with respect to vehicles produced by you and your affiliated companies. Treat these drayage tractors as being in their own averaging set.

(x) *Transition to updated GEM.* (1) Vehicle manufacturers may demonstrate compliance with Phase 2 greenhouse gas standards in model years 2021 through 2023 using GEM Phase 2, Version 3.0, Version 3.5.1, or Version 4.0 (all incorporated by reference, see § 1037.810). Manufacturers may change to a different version of GEM for model years 2022 and 2023 for a given vehicle family after initially submitting an application for certification; such a change must be documented as an amendment under § 1037.225.

Manufacturers may submit an end-of-year report for model year 2021 using any of the three regulatory versions of GEM, but only for demonstrating compliance with the custom-chassis standards in § 1037.105(h); such a change must be documented in the report submitted under § 1037.730. Once a manufacturer certifies a vehicle family based on GEM Version 4.0, it may not revert back to using GEM Phase 2, Version 3.0 or Version 3.5.1 for that vehicle family in any model year.

(2) Vehicle manufacturers may certify for model years 2021 through 2023 based on fuel maps from engines or powertrains that were created using GEM Phase 2, Version 3.0, Version 3.5.1, or Version 4.0 (all incorporated by reference, see § 1037.810). Vehicle manufacturers may alternatively certify in those years based on fuel maps from powertrains that were created using GEM Phase 2, Version 3.0, GEM HIL model 3.8, or GEM Phase 2, Version 4.0 (all incorporated by reference, see § 1037.810). Vehicle manufacturers may continue to certify vehicles in later model years using fuel maps generated with earlier versions of GEM for model year 2024 and later vehicle families that qualify for using carryover provisions in § 1037.235(d).

(y) *Correcting credit calculations.* If you notify us by October 1, 2024, that errors mistakenly decreased your balance of emission credits for 2020 or any earlier model years, you may correct the errors and recalculate the balance of emission credits after applying a 10 percent discount to the credit correction.

(z) *Credit exchanges across averaging sets for certain vehicles.* The provisions of this paragraph (z) apply for credits generated from model year 2026 and earlier vehicles certified with advanced technology under this part. The provisions of this paragraph (z) also

apply for credits generated from model year 2027 through 2032 vehicles, as follows:

(1) Credits generated under this part may be used through model year 2032 for any of the averaging sets identified in § 1037.740(a).

(2) Credits generated from vehicles certified to the standards in 40 CFR 86.1819–14 may be used through model year 2032 to demonstrate compliance with the CO<sub>2</sub> emission standards for Light HDV or Medium HDV in this part.

(3) The following provisions apply for redesignating credits for use in different averaging sets:

(i) The restrictions that apply for trading credits under § 1037.720 also apply for redesignating credits.

(ii) Send us a report by June 30 after model year to describe how you are redesignating credits. Identify the averaging set and number of credits generated from each vehicle family. Also identify the number of redesignated emission credits you intend to apply for each averaging set.

(4) You may trade redesignated credits as allowed under the standard setting part. Credit provisions not addressed in this paragraph (z), such as limitations on credit life and credit multipliers for advanced technology, continue to apply as specified.

(aa) *Warranty for advanced technologies.* The emission-related warranty requirements in § 1037.120 are optional for fuel cell stacks, RESS, and other components used with battery electric vehicles and fuel cell electric vehicles before model year 2027.

■ 65. Amend § 1037.205 by revising the introductory text and paragraphs (a), (b) introductory text, (b)(6), (e), (o), and (q) to read as follows:

**§ 1037.205 What must I include in my application?**

This section specifies the information that must be in your application, unless we ask you to include less information under § 1037.201(c). We may require you to provide additional information to evaluate your application. References to testing and emission-data vehicles refer to testing vehicles or components to measure any quantity that serves as an input value for modeling emission rates under § 1037.520.

(a) Describe the vehicle family's specifications and other basic parameters of the vehicle's design and emission controls. List the fuel type on which your vehicles are designed to operate (for example, ultra-low-sulfur diesel fuel).

(b) Explain how the emission control system operates. As applicable, describe in detail all system components for

controlling greenhouse gas emissions, including all auxiliary emission control devices (AECDs) and all fuel-system components you will install on any production vehicle. For any vehicle using RESS (such as hybrid vehicles, fuel cell electric vehicles, and battery electric vehicles), describe in detail all components needed to charge the system, store energy, and transmit power to move the vehicle. Identify the part number of each component you describe. For this paragraph (b), treat as separate AECDs any devices that modulate or activate differently from each other. Also describe your modeling inputs as described in § 1037.520, with the following additional information if it applies for your vehicles:

\* \* \* \* \*

(6) If you perform powertrain testing under 40 CFR 1036.545, report both CO<sub>2</sub> and NO<sub>x</sub> emission levels corresponding to each test run.

\* \* \* \* \*

(e) Describe any test equipment and procedures that you used, including any special or alternate test procedures you used (see § 1037.501). Include information describing the procedures you used to determine *C<sub>dA</sub>* values as specified in §§ 1037.525 and 1037.527. Describe which type of data you are using for engine fuel maps (see 40 CFR 1036.505).

\* \* \* \* \*

(o) Report calculated and modeled emission results for ten configurations. Include modeling inputs and detailed descriptions of how they were derived. Unless we specify otherwise, include the configuration with the highest modeling result, the lowest modeling result, and the configurations with the highest projected sales.

\* \* \* \* \*

(q) For battery electric vehicles and plug-in hybrid electric vehicles, describe the recharging procedures and methods for determining battery performance, such as state of charge and charging capacity. Also include the certified usable battery energy for each battery durability subfamily.

\* \* \* \* \*

**§ 1037.211 [Removed]**

- 66. Remove § 1037.211.
- 67. Amend § 1037.230 by:
  - a. Revising paragraph (a)(1) introductory text;
  - b. Removing paragraph (a)(3);
  - c. Revising paragraph (d)(2) introductory text; and
  - d. Removing paragraph (d)(3).The revisions read as follows:

**§ 1037.230 Vehicle families, sub-families, and configurations.**

(a) \* \* \*  
(1) Apply subcategories for vocational vehicles and vocational tractors as shown in table 1 of this section. This involves 15 separate subcategories for Phase 2 and later vehicles to account for engine characteristics, GVWR, and the selection of duty cycle for vocational vehicles as specified in § 1037.510; vehicles may additionally fall into one of the subcategories defined by the custom-chassis standards in § 1037.105(h). Divide Phase 1 vehicles into three GVWR-based vehicle service classes as shown in table 1 of this section, disregarding additional specified characteristics. Table 1 follows:

\* \* \* \* \*

(d) \* \* \*  
(2) For a Phase 2 or later vehicle model that includes a range of GVWR values that straddle weight classes, you may include all the vehicles in the same vehicle family if you certify the vehicle family to the numerically lower CO<sub>2</sub> emission standard from the affected service classes. Vehicles that are optionally certified to a more stringent standard under this paragraph (d)(2) are subject to useful-life and all other provisions corresponding to the weight class with the numerically lower CO<sub>2</sub> emission standard. For a Phase 2 or later tractor model that includes a range of roof heights that straddle subcategories, you may include all the vehicles in the same vehicle family if you certify the vehicle family to the appropriate subcategory as follows:

\* \* \* \* \*

■ 68. Amend § 1037.231 by revising paragraph (a) to read as follows:

**§ 1037.231 Powertrain families.**

(a) If you choose to perform powertrain testing as specified in 40 CFR 1036.545, use good engineering judgment to divide your product line into powertrain families that are expected to have similar fuel consumptions and CO<sub>2</sub> emission characteristics throughout the useful life. Your powertrain family is limited to a single model year.

\* \* \* \* \*

■ 69. Amend § 1037.235 by:

- a. Revising the introductory text and paragraphs (a) and (c)(3); and
- b. Removing paragraph (g)(3).

The revisions read as follows:

**§ 1037.235 Testing requirements for certification.**

This section describes the emission testing you must perform to show

compliance with respect to the greenhouse gas standards in subpart B of this part, and to determine any input values from § 1037.520 that involve measured quantities.

(a) Select emission-data vehicles that represent production vehicles and components for the vehicle family consistent with the specifications in §§ 1037.205(o) and 1037.520. Where the test results will represent multiple vehicles or components with different emission performance, use good engineering judgment to select worst-case emission data vehicles or components. In the case of powertrain testing under 40 CFR 1036.545, select a test engine, test hybrid components, test axle and test transmission as applicable, by considering the whole range of vehicle models covered by the powertrain family and the mix of duty cycles specified in § 1037.510. If the powertrain has more than one transmission calibration, for example economy vs. performance, you may weight the results from the powertrain testing in 40 CFR 1036.545 by the percentage of vehicles in the family by prior model year for each configuration. This can be done, for example, through the use of survey data or based on the previous model year's sales volume. Weight the results of  $M_{fuel[cycle]}$ ,  $f_{npowertrain}/V_{powertrain}$ , and  $W_{[cycle]}$  from table 5 to paragraph (o)(8)(i) of 40 CFR 1036.545 according to the percentage of vehicles in the family that use each transmission calibration.

\* \* \* \* \*

(c) \* \* \*  
(3) Before we test one of your vehicles or components, we may set its adjustable parameters to any point within the practically adjustable ranges, if applicable.

\* \* \* \* \*

■ 70. Revise § 1037.241 to read as follows:

**§ 1037.241 Demonstrating compliance with exhaust emission standards for greenhouse gas pollutants.**

(a) Compliance determinations for purposes of certification depend on whether or not you participate in the ABT program in subpart H of this part.

(1) If none of your vehicle families generate or use emission credits in a given model year, each of your vehicle families is considered in compliance with the CO<sub>2</sub> emission standards in §§ 1037.105 and 1037.106 if all vehicle configurations in the family have modeled CO<sub>2</sub> emission rates from § 1037.520 that are at or below the applicable standards. A vehicle family is deemed not to comply if any vehicle

configuration in the family has a modeled CO<sub>2</sub> emission rate that is above the applicable standard.

(2) If you generate or use emission credits with one or more vehicle families in a given model year, your vehicle families within an averaging set are considered in compliance with the CO<sub>2</sub> emission standards in §§ 1037.105 and 1037.106 if the sum of positive and negative credits for all vehicle configurations in those vehicle families lead to a zero balance or a positive balance of credits, except as allowed by § 1037.745. Note that the FEL is considered to be the applicable emission standard for an individual configuration.

(b) We may require you to provide an engineering analysis showing that the performance of your emission controls will not deteriorate during the useful life with proper maintenance. If we determine that your emission controls are likely to deteriorate during the useful life, we may require you to develop and apply deterioration factors consistent with good engineering judgment. For example, you may need to apply a deterioration factor to address deterioration of battery performance for a hybrid vehicle. Where the highest useful life emissions occur between the end of useful life and at the low-hour test point, base deterioration factors for the vehicles on the difference between (or ratio of) the point at which the highest emissions occur and the low-hour test point.

**§ 1037.310 [Removed]**

- 71. Remove § 1037.310.
- 72. Amend § 1037.315 by revising paragraph (a) to read as follows:

**§ 1037.315 Audit procedures related to powertrain testing.**

(a) For vehicles certified based on powertrain testing as specified in 40 CFR 1036.545, we may apply the selective enforcement audit requirements to the powertrain. If engine manufacturers perform the powertrain testing and include those results in their certification under 40 CFR part 1036, they are responsible for selective enforcement audits related to those results. Otherwise, the certificate holder for the vehicle is responsible for the selective enforcement audit.

\* \* \* \* \*

- 73. Amend § 1037.401 by revising paragraph (b) to read as follows:

**§ 1037.401 General provisions.**

\* \* \* \* \*

(b) We may measure the drag area of a vehicle you produced after it has been placed into service. We may use any of

the procedures as specified in §§ 1037.525 and 1037.527 for measuring drag area. Your vehicle conforms to the regulations of this part with respect to aerodynamic performance if we measure its drag area to be at or below the maximum drag area allowed for the bin to which that configuration was certified.

- 74. Amend § 1037.501 by:
  - a. Revising paragraphs (a), (g)(1)(v), and (h); and
  - b. Removing paragraph (i).

The revisions read as follows:

**§ 1037.501 General testing and modeling provisions.**

\* \* \* \* \*

(a) Except as specified in subpart B of this part, you must demonstrate that you meet emission standards using emission modeling as described in § 1037.520. This modeling depends on several measured values as described in this subpart. You may use fuel-mapping information from the engine manufacturer as described in 40 CFR 1036.535 and 1036.540, or you may use powertrain testing as described in 40 CFR 1036.545.

\* \* \* \* \*

- (g) \* \* \*
- (1) \* \* \*

(v) For the Phase 2 or later standards, include side skirts meeting the specifications of this paragraph (g)(1)(v). The side skirts must be mounted flush with both sides of the trailer. The skirts must be an isosceles trapezoidal shape. Each skirt must have a height of 36±2 inches. The top edge of the skirt must be straight with a length of 341±2 inches. The bottom edge of the skirt must be straight with a length of 268±2 inches and have a ground clearance of 8±2 inches through that full length. The sides of the skirts must be straight. The rearmost point of the skirts must be mounted 32±2 inches in front of the centerline of the trailer tandem axle assembly. We may approve your request to use a skirt with different dimensions if these specified values are impractical or inappropriate for your test trailer, and you propose alternative dimensions that provide an equivalent or comparable degree of aerodynamic drag for your test configuration.

\* \* \* \* \*

(h) Note that declared GEM inputs for fuel maps and aerodynamic drag area typically includes compliance margins to account for testing variability; for other measured GEM inputs, the declared values are typically the measured values without adjustment.

- 75. Revise and republish § 1037.510 to read as follows:

**§ 1037.510 Duty-cycle exhaust testing.**

This section applies for powertrain testing, cycle-average engine fuel mapping, certain off-cycle testing under § 1037.610, and the advanced-technology provisions of § 1037.615.

(a) Measure emissions by testing the powertrain on a powertrain dynamometer with the applicable duty cycles. Each duty cycle consists of a series of speed commands over time—variable speeds for the transient test and constant speeds for the highway cruise tests. None of these cycles include vehicle starting or warmup.

(1) Perform testing for Phase 1 vehicles as follows to generate credits or adjustment factors for off-cycle or advanced technologies:

(i) *Transient cycle.* The transient cycle is specified in appendix A to this part. Warm up the vehicle. Start the duty cycle within 30 seconds after concluding the preconditioning procedure. Start sampling emissions at the start of the duty cycle.

(ii) *Cruise cycle.* For the 55 mi/hr and 65 mi/hr highway cruise cycles, warm up the vehicle at the test speed, then sample emissions for 300 seconds while maintaining vehicle speed within ±1.0 mi/hr of the speed setpoint; this speed tolerance applies instead of the approach specified in 40 CFR 1066.425(b)(1) and (2).

(2) Perform cycle-average engine fuel mapping for Phase 2 and later vehicles as described in 40 CFR 1036.540. For powertrain testing under 40 CFR 1036.545 or § 1037.555, perform testing as described in this paragraph (a)(2) to generate GEM inputs for each simulated vehicle configuration, and test runs representing different idle conditions. Perform testing as follows:

(i) *Transient cycle.* The transient cycle is specified in appendix A to this part.

(ii) *Highway cruise cycles.* The grade portion of the route corresponding to the 55 mi/hr and 65 mi/hr highway cruise cycles is specified in appendix D to this part. Maintain vehicle speed between -1.0 mi/hr and 3.0 mi/hr of the speed setpoint; this speed tolerance applies instead of the approach specified in 40 CFR 1066.425(b)(1) and (2).

(iii) *Drive idle.* Perform testing at a loaded idle condition for Phase 2 vocational vehicles. For engines with an adjustable warm idle speed setpoint, test at the minimum warm idle speed and the maximum warm idle speed; otherwise simply test at the engine's warm idle speed. Warm up the powertrain as described in 40 CFR 1036.520(d). Within 60 seconds after concluding the warm-up, linearly ramp the powertrain down to zero vehicle

speed over 20 seconds. Apply the brake and keep the transmission in drive (or clutch depressed for manual transmission). Stabilize the powertrain for (60±1) seconds and then sample emissions for (30±1) seconds.

(iv) *Parked idle*. Perform testing at a no-load idle condition for Phase 2 vocational vehicles. For engines with an adjustable warm idle speed setpoint, test at the minimum warm idle speed and the maximum warm idle speed; otherwise simply test at the engine's warm idle speed. Warm up the powertrain as described in 40 CFR 1036.520(d). Within 60 seconds after concluding the warm-up, linearly ramp

the powertrain down to zero vehicle speed in 20 seconds. Put the transmission in park (or neutral for manual transmissions and apply the parking brake if applicable). Stabilize the powertrain for (180±1) seconds and then sample emissions for (600±1) seconds.

(3) Where applicable, perform testing on a chassis dynamometer as follows:

(i) *Transient cycle*. The transient cycle is specified in appendix A to this part. Warm up the vehicle by operating over one transient cycle. Within 60 seconds after concluding the warm up cycle, start emission sampling and operate the vehicle over the duty cycle.

(ii) *Highway cruise cycle*. The grade portion of the route corresponding to the 55 mi/hr and 65 mi/hr highway cruise cycles is specified in appendix D to this part. Warm up the vehicle by operating it at the appropriate speed setpoint over the duty cycle. Within 60 seconds after concluding the preconditioning cycle, start emission sampling and operate the vehicle over the duty cycle, maintaining vehicle speed within ±1.0 mi/hr of the speed setpoint; this speed tolerance applies instead of the approach specified in 40 CFR 1066.425(b)(1) and (2).

(b) Calculate the official emission result from the following equation:

$$e_{CO2comp} = \frac{1}{PL \cdot \bar{v}_{moving} \cdot (1 - w_{drive-idle} - w_{parked-idle}) + \left( (1 - w_{drive-idle} - w_{parked-idle}) \cdot \left( \frac{w_{transient} \cdot m_{transient}}{D_{transient}} + \frac{w_{55} \cdot m_{55}}{D_{55}} + \frac{w_{65} \cdot m_{65}}{D_{65}} \right) \cdot \bar{v}_{moving} \right) + w_{drive-idle} \cdot \bar{m}_{drive-idle} + w_{parked-idle} \cdot \bar{m}_{parked-idle}}$$

**Eq. 1037.510-1**

Where:

$e_{CO2comp}$  = total composite mass of CO<sub>2</sub> emissions in g/ton-mile, rounded to the nearest whole number for vocational vehicles and to the first decimal place for tractors.

$PL$  = the standard payload, in tons, as specified in § 1037.705.

$\bar{v}_{moving}$  = mean composite weighted driven vehicle speed, excluding idle operation, as shown in table 1 to paragraph (c)(3) of this section for Phase 2 vocational vehicles. For other vehicles, let  $\bar{v}_{moving} = 1$ .

$w_{[cycle]}$  = weighting factor for the appropriate test cycle, as shown in table 1 to paragraph (c)(3) of this section.

$m_{[cycle]}$  = CO<sub>2</sub> mass emissions over each test cycle (other than idle).

$D_{[cycle]}$  = the total driving distance for the indicated duty cycle. Use 2.842 miles for the transient cycle, and use 13.429 miles for both of the highway cruise cycles.

$\bar{m}_{[cycle]-idle}$  = CO<sub>2</sub> emission rate at idle.

*Example:* Class 7 vocational vehicle meeting the Phase 2 standards based on the Regional duty cycle.

$PL = 5.6$  tons  
 $\bar{v}_{moving} = 38.41$  mi/hr

$w_{transient} = 20\% = 0.20$

$w_{drive-idle} = 0\% = 0$

$w_{parked-idle} = 25\% = 0.25$

$w_{55} = 24\% = 0.24$

$w_{65} = 56\% = 0.56$

$m_{transient} = 4083$  g

$m_{55} = 13834$  g

$m_{65} = 17018$  g

$D_{transient} = 2.8449$  miles

$D_{55} = 13.429$  miles

$D_{65} = 13.429$  miles

$\bar{m}_{drive-idle} = 4188$  g/hr

$\bar{m}_{parked-idle} = 3709$  g/hr

$$e_{CO2} = \frac{1}{5.6 \cdot 38.41 \cdot (1 - 0 - 0.25) + \left( (1 - 0.0 - 0.25) \cdot \left( \frac{0.20 \cdot 4083}{2.8449} + \frac{0.24 \cdot 13834}{13.429} + \frac{0.56 \cdot 17018}{13.429} \right) \right) + 38.41 + 0.0 \cdot 4188 + 0.25 \cdot 3709}$$

$e_{CO2} = 228$  g/ton-mile

(c) Weighting factors apply for each type of vehicle and for each duty cycle as follows:

(1) GEM applies weighting factors for specific types of tractors as shown in table 1 to paragraph (c)(3) of this section.

(2) GEM applies weighting factors for vocational vehicles as shown in table 1 to paragraph (c)(3) of this section.

Modeling for Phase 2 vocational vehicles depends on characterizing vehicles by duty cycle to apply proper weighting factors and average speed

values. Select either Urban, Regional, or Multi-Purpose as the most appropriate duty cycle for modeling emission results with each vehicle configuration, as specified in §§ 1037.140 and 1037.150.

(3) Table 1 to this paragraph (c)(3) follows:

TABLE 1 TO PARAGRAPH (c)(3) OF § 1037.510—WEIGHTING FACTORS FOR DUTY CYCLES

	Distance-weighted			Time-weighted <sup>a</sup>			Average speed during non-idle cycles (mi/hr) <sup>b</sup>
	Transient (%)	55 mi/hr cruise (%)	65 mi/hr cruise (%)	Drive idle (%)	Parked idle (%)	Non-idle (%)	
Day Cabs .....	19	17	64				
Sleeper Cabs .....	5	9	86				
Heavy-haul Tractors .....	19	17	64				
Vocational—Regional .....	20	24	56	0	25	75	38.41
Vocational—Multi-Purpose (2b–7) .....	54	29	17	17	25	58	23.18
Vocational—Multi-Purpose (8) .....	54	23	23	17	25	58	23.27
Vocational—Urban (2b–7) .....	92	8	0	15	25	60	16.25
Vocational—Urban (8) .....	90	10	0	15	25	60	16.51
Vocational with conventional powertrain (Phase 1 only) .....	42	21	37				
Vocational Hybrid Vehicles (Phase 1 only) ...	75	9	16				

<sup>a</sup>Note that these drive idle and non-idle weighting factors do not reflect additional drive idle that occurs during the transient cycle. The transient cycle does not include any parked idle.  
<sup>b</sup>These values apply even for vehicles not following the specified speed traces.

(d) For highway cruise and transient testing, compare actual second-by-second vehicle speed with the speed specified in the test cycle and ensure any differences are consistent with the criteria as specified in 40 CFR 1036.545(g)(1). If the speeds are not consistent with the criteria as specified in 40 CFR 1036.545(g)(1), the test is not valid and must be repeated.

(e) Run test cycles as specified in 40 CFR part 1066. For testing vehicles equipped with cruise control over the highway cruise cycles, you may use the vehicle's cruise control to control the vehicle speed. For vehicles equipped with adjustable vehicle speed limiters, test the vehicle with the vehicle speed limiter at its highest setting.

(f) For Phase 1, test the vehicle using its adjusted loaded vehicle weight, unless we determine this would be unrepresentative of in-use operation as specified in 40 CFR 1065.10(c)(1).

(g) For hybrid vehicles, correct for the net energy change of the energy storage

device as described in 40 CFR 1066.501(a)(3).

**§ 1037.515 [Removed]**

■ 76. Remove § 1037.515.

■ 77. Amend § 1037.520 by revising the section heading, introductory text, and paragraphs (a)(2) introductory text, (b)(3), (c)(1) and (2), (e)(1) and (3), (g)(4), (j)(1), and (j)(2)(iii) to read as follows:

**§ 1037.520 Modeling CO<sub>2</sub> emissions to show that vehicles comply with standards.**

This section describes how to use the Greenhouse gas Emissions Model (GEM) to show compliance with the CO<sub>2</sub> standards of §§ 1037.105 and 1037.106. Use GEM version 2.0.1 to demonstrate compliance with Phase 1 standards; use GEM Phase 2, Version 4.0 to demonstrate compliance with Phase 2 and Phase 3 standards (both incorporated by reference, see § 1037.810). Use good engineering judgment when demonstrating compliance using GEM.

(a) \* \* \*

(2) For Phase 2 and later vehicles, the GEM inputs described in paragraphs (a)(1)(i) through (v) of this section continue to apply. Note that the provisions in this part related to vehicle speed limiters and automatic engine shutdown systems are available for Phase 2 and later vocational vehicles. The rest of this section describes additional GEM inputs for demonstrating compliance with Phase 2 and later standards. Simplified versions of GEM apply for limited circumstances as follows:

\* \* \* \* \*

(b) \* \* \*

(3) For Phase 2 and later tractors other than heavy-haul tractors, determine bin levels and C<sub>d</sub>A inputs as follows:

(i) Determine bin levels for high-roof tractors based on aerodynamic test results as specified in § 1037.525 and summarized in the following table:

TABLE 3 TO PARAGRAPH (b)(3)(i) OF § 1037.520—BIN DETERMINATIONS FOR PHASE 2 AND LATER HIGH-ROOF TRACTORS BASED ON AERODYNAMIC TEST RESULTS

[C<sub>d</sub>A in m<sup>2</sup>]

Tractor type	Bin I	Bin II	Bin III	Bin IV	Bin V	Bin VI	Bin VII
Day Cabs .....	≥7.2	6.6–7.1	6.0–6.5	5.5–5.9	5.0–5.4	4.5–4.9	≤4.4
Sleeper Cabs .....	≥6.9	6.3–6.8	5.7–6.2	5.2–5.6	4.7–5.1	4.2–4.6	≤4.1

(ii) For low- and mid-roof tractors, you may either use the same bin level that applies for an equivalent high-roof

tractor as shown in table 3 to paragraph (b)(3)(i) of this section, or you may determine your bin level based on

aerodynamic test results as described in table 4 to this paragraph (b)(3)(ii).



TABLE 4 TO PARAGRAPH (b)(3)(ii) OF § 1037.520—BIN DETERMINATIONS FOR PHASE 2 AND LATER LOW-ROOF AND MID-ROOF TRACTORS BASED ON AERODYNAMIC TEST RESULTS

[ $C_dA$  in  $m^2$ ]

Tractor type	Bin I	Bin II	Bin III	Bin IV	Bin V	Bin VI	Bin VII
Low-Roof Cabs .....	≥5.4	4.9–5.3	4.5–4.8	4.1–4.4	3.8–4.0	3.5–3.7	≤3.4
Mid-Roof Cabs .....	≥5.9	5.5–5.8	5.1–5.4	4.7–5.0	4.4–4.6	4.1–4.3	≤4.0

(iii) Determine the  $C_dA$  input according to the tractor’s bin level as described in the following table:

TABLE 5 TO PARAGRAPH (b)(3)(iii) OF § 1037.520—PHASE 2 AND LATER  $C_dA$  TRACTOR INPUTS BASED ON BIN LEVEL

Tractor type	Bin I	Bin II	Bin III	Bin IV	Bin V	Bin VI	Bin VII
High-Roof Day Cabs .....	7.45	6.85	6.25	5.70	5.20	4.70	4.20
High-Roof Sleeper Cabs .....	7.15	6.55	5.95	5.40	4.90	4.40	3.90
Low-Roof Cabs .....	6.00	5.60	5.15	4.75	4.40	4.10	3.80
Mid-Roof Cabs .....	7.00	6.65	6.25	5.85	5.50	5.20	4.90

\* \* \* \* \*

(c) \* \* \*

(1) Use good engineering judgment to determine a tire’s revolutions per mile to the nearest whole number as specified in SAE J1025 (incorporated by reference, see § 1037.810). Note that for tire sizes that you do not test, we will treat your analytically derived revolutions per mile the same as test results, and we may perform our own testing to verify your values. We may require you to test a sample of additional tire sizes that we select.

(2) Measure tire rolling resistance in newton per kilonewton as specified in

ISO 28580 (incorporated by reference, see § 1037.810), except as specified in this paragraph (c). Use good engineering judgment to ensure that your test results are not biased low. You may ask us to identify a reference test laboratory to which you may correlate your test results. Prior to beginning the test procedure in Section 7 of ISO 28580 for a new bias-ply tire, perform a break-in procedure by running the tire at the specified test speed, load, and pressure for (60±2) minutes.

\* \* \* \* \*

(e) \* \* \*

(1) Vehicle weight reduction inputs for wheels are specified relative to dual-wide tires with conventional steel wheels. For purposes of this paragraph (e)(1), an aluminum alloy qualifies as light-weight if a dual-wide drive wheel made from this material weighs at least 21 pounds less than a comparable conventional steel wheel. The inputs are listed in table 6 to this paragraph (e)(1). For example, a tractor or vocational vehicle with aluminum steer wheels and eight (4×2) dual-wide aluminum drive wheels would have an input of 210 pounds (2×21 + 8×21).

TABLE 6 TO PARAGRAPH (e)(1) OF § 1037.520—WHEEL-RELATED WEIGHT REDUCTIONS

Tire type	Material	Weight reduction—Phase 1 (pounds per wheel)	Weight reduction—Phase 2 and later (pounds per wheel)
Wide-Base Single Drive Tire with . . . <sup>a</sup> .....	Steel Wheel .....	84	84
	Aluminum Wheel .....	139	147
	Light-Weight Aluminum Alloy Wheel .....	147	147
Steer Tire or Dual-wide Drive Tire with . . . .....	High-Strength Steel Wheel .....	8	8
	Aluminum Wheel .....	21	25
	Light-Weight Aluminum Alloy Wheel .....	30	25

<sup>a</sup> The weight reduction for wide-base tires accounts for reduced tire weight relative to dual-wide tires.

\* \* \* \* \*

(3) Weight-reduction inputs for vocational-vehicle components other

than wheels are specified in the following table:

TABLE 8 TO PARAGRAPH (e)(3) OF § 1037.520—NONWHEEL-RELATED WEIGHT REDUCTIONS FROM ALTERNATIVE MATERIALS FOR PHASE 2 AND LATER VOCATIONAL VEHICLES

[Pounds]<sup>a</sup>

Component	Material	Vehicle type		
		Light HDV	Medium HDV <sup>b</sup>	Heavy HDV
Axle Hubs—Non-Drive .....	Aluminum .....	40		40

TABLE 8 TO PARAGRAPH (e)(3) OF § 1037.520—NONWHEEL-RELATED WEIGHT REDUCTIONS FROM ALTERNATIVE MATERIALS FOR PHASE 2 AND LATER VOCATIONAL VEHICLES—Continued

[Pounds]<sup>a</sup>

Component	Material	Vehicle type		
		Light HDV	Medium HDV <sup>b</sup>	Heavy HDV
Axle Hubs—Non-Drive	High Strength Steel	5		5
Axle—Non-Drive	Aluminum	60		60
Axle—Non-Drive	High Strength Steel	15		15
Brake Drums—Non-Drive	Aluminum	60		60
Brake Drums—Non-Drive	High Strength Steel	42		42
Axle Hubs—Drive	Aluminum	40		80
Axle Hubs—Drive	High Strength Steel	10		20
Brake Drums—Drive	Aluminum	70		140
Brake Drums—Drive	High Strength Steel	37		74
Suspension Brackets, Hangers	Aluminum	67		100
Suspension Brackets, Hangers	High Strength Steel	20		30
Crossmember—Cab	Aluminum	10	15	15
Crossmember—Cab	High Strength Steel	2	5	5
Crossmember—Non-Suspension	Aluminum	15	15	15
Crossmember—Non-Suspension	High Strength Steel	5	5	5
Crossmember—Suspension	Aluminum	15	25	25
Crossmember—Suspension	High Strength Steel	6	6	6
Driveshaft	Aluminum	12	40	50
Driveshaft	High Strength Steel	5	10	12
Frame Rails	Aluminum	120	300	440
Frame Rails	High Strength Steel	40	40	87

<sup>a</sup> Weight-reduction values apply per vehicle unless otherwise noted.

<sup>b</sup> For Medium HDV with 6×4 or 6×2 axle configurations, use the values for Heavy HDV.

\* \* \* \* \*

(g) \* \* \*

(4) GEM inputs associated with powertrain testing include powertrain family, transmission calibration identifier, test data from 40 CFR 1036.545, and the powertrain test configuration (dynamometer connected to transmission output or wheel hub). You do not need to identify or provide inputs for transmission gear ratios, fuel map data, or engine torque curves, which would otherwise be required under paragraph (f) of this section.

\* \* \* \* \*

(j) \* \* \*

(1) *Intelligent controls.* Enter 2 for tractors with predictive cruise control. This includes any cruise control system that incorporates satellite-based global-positioning data for controlling operator demand. For tractors without predictive cruise control and for all vocational vehicles, enter 1.5 if they have neutral coasting or the installed engine deactivates all cylinders closing all intake and exhaust valves when operator demand is zero while the vehicle is in motion, unless good engineering judgment indicates that a lower percentage should apply.

(2) \* \* \*

(iii) If vehicles have a high-efficiency air conditioning compressor, enter 0.5 for tractors, 0.5 for vocational Heavy HDV, and 1 for other vocational vehicles. This includes all electrically

powered compressors. It also include mechanically powered compressors if the coefficient of performance improves by 10 percent or greater over the baseline design, consistent with the provisions for improved evaporators and condensers in 40 CFR 86.1868–12(h)(5).

\* \* \* \* \*

■ 78. Amend § 1037.525 by revising paragraphs (a) introductory text, (b), (c)(1) introductory text, (c)(2) introductory text, and (c)(3)(v) to read as follows:

**§ 1037.525 Aerodynamic measurements for tractors.**

\* \* \* \* \*

(a) *General provisions.* The GEM input for a tractor's aerodynamic performance is a  $C_d$  value for Phase 1 and a  $C_dA$  value for Phase 2 and later. The input value is measured or calculated for a tractor in a specific test configuration with a trailer, such as a high-roof tractor with a box van meeting the requirements for the standard trailer.

\* \* \* \* \*

(b) *Adjustments to correlate with coastdown testing.* Adjust aerodynamic drag values from alternate methods to be equivalent to the corresponding values from coastdown measurements as follows:

(1) Determine the functional relationship between your alternate method and coastdown testing. Specify

this functional relationship as  $F_{alt-aero}$  for a given alternate drag measurement method. The effective yaw angle,  $\psi_{eff}$ , is assumed to be zero degrees for Phase 1. For Phase 2 and later, determine  $\psi_{eff}$  from coastdown test results using the following equation:

$$F_{alt-aero} = \frac{C_d A_{coastdown}(\psi_{eff})}{C_d A_{alt}(\psi_{eff})}$$

Eq. 1037.525–1

Where:

$C_d A_{coastdown}(\psi_{eff})$  = the average drag area measured during coastdown at an effective yaw angle,  $\psi_{eff}$ .

$C_d A_{alt}(\psi_{eff})$  = the average drag area calculated from an alternate drag measurement method at an effective yaw angle,  $\psi_{eff}$ .

(2) Unless good engineering judgment dictates otherwise, assume that coastdown drag is proportional to drag measured using alternate methods and apply a constant adjustment factor,  $F_{alt-aero}$ , for a given alternate drag measurement method of similar vehicles.

(3) Determine  $F_{alt-aero}$  by performing coastdown testing and applying your alternate method on the same vehicles. Consider all applicable test data including data collected during selective enforcement audits. Unless we approve another vehicle, one vehicle must be a Class 8 high-roof sleeper cab with a full aerodynamics package pulling a standard trailer. Where you

have more than one tractor model meeting these criteria, use the tractor model with the highest projected sales. If you do not have such a tractor model, you may use your most comparable tractor model with our prior approval. In the case of alternate methods other than those specified in this subpart, good engineering judgment may require you to determine your adjustment factor based on results from more than the specified minimum number of vehicles.

(4) Measure the drag area using your alternate method for a Phase 2 and later tractor used to determine  $F_{alt-aero}$  with testing at yaw angles of  $0^\circ$ ,  $\pm 1^\circ$ ,  $\pm 3^\circ$ ,  $\pm 4.5^\circ$ ,  $\pm 6^\circ$ , and  $\pm 9^\circ$  (you may include additional angles), using direction conventions described in Figure 2 of SAE J1252 (incorporated by reference, see § 1037.810). Also, determine the drag area at the coastdown effective yaw angle,  $C_d A_{alt}(\Psi_{eff})$ , by taking the average drag area at  $\Psi_{eff}$  and  $-\Psi_{eff}$  for your vehicle using the same alternate method.

(5) For Phase 2 and later testing, determine separate values of  $F_{alt-aero}$  for at least one high-roof day cab and one high-roof sleeper cab for model year 2021, at least two high-roof day cabs and two high-roof sleeper cabs for model year 2024, and at least three high-roof day cabs and three high-roof sleeper cabs for model year 2027. These test requirements are cumulative; for example, you may meet these requirements by testing two vehicles to support model year 2021 certification and four additional vehicles to support model year 2023 certification. For any untested tractor models, apply the value of  $F_{alt-aero}$  from the tested tractor model that best represents the aerodynamic characteristics of the untested tractor model, consistent with good engineering judgment. Testing under this paragraph (b)(5) continues to be valid for later model years until you change the tractor model in a way that causes the test results to no longer represent production vehicles. You must also determine unique values of  $F_{alt-aero}$  for low-roof and mid-roof tractors if you determine  $C_d A$  values based on low or mid-roof tractor testing as shown in § 1037.520(b)(3)(ii). For Phase 1 testing, if good engineering judgment allows it, you may calculate a single, constant value of  $F_{alt-aero}$  for your whole product line by dividing the coastdown drag area,  $C_d A_{coastdown}$ , by drag area from your alternate method,  $C_d A_{alt}$ .

(6) Determine  $F_{alt-aero}$  to at least three decimal places. For example, if your coastdown testing results in a drag area of 6.430, but your wind tunnel method results in a drag area of 6.200,  $F_{alt-aero}$

would be 1.037 (or a higher value you declare).

(7) If a tractor and trailer cannot be configured to meet the gap requirements specified in § 1037.501(g)(1)(ii), test with the trailer positioned as close as possible to the specified gap dimension and use good engineering judgment to correct the results to be equivalent to a test configuration meeting the specified gap dimension. For example, we may allow you to correct your test output using an approved alternate method or substitute a test vehicle that is capable of meeting the required specifications and is otherwise aerodynamically equivalent. The allowance in this paragraph (b)(7) applies for certification, confirmatory testing, SEA, and all other testing to demonstrate compliance with standards.

(8) You may ask us for preliminary approval of your coastdown testing under § 1037.210. We may witness the testing.

(c) \* \* \*

(1) Apply the following method for all Phase 2 and later testing with an alternate method:

\* \* \* \* \*

(2) Apply the following method for Phase 2 and later coastdown testing other than coastdown testing used to establish  $F_{alt-aero}$ :

\* \* \* \* \*

(3) \* \* \*

(v) As an alternative, you may calculate the wind-averaged drag area according to SAE J1252 (incorporated by reference, see § 1037.810) and substitute this value into Eq. 1037.525–4 for the  $\pm 6^\circ$  drag area.

\* \* \* \* \*

**§ 1037.526 [Removed]**

■ 79. Remove § 1037.526.

■ 80. Revise § 1037.527 to read as follows:

**§ 1037.527 Aerodynamic measurements for vocational vehicles.**

This section describes an optional methodology for determining improved aerodynamic drag area,  $C_d A$ , for vocational vehicles, as described in § 1037.520(m), rather than using the assigned values. A vocational vehicle's aerodynamic performance is based on a  $\Delta C_d A$  value relative to a baseline vehicle. Determine a  $\Delta_d A$  value by performing A to B testing as follows:

(a) Use any of the procedures described in this subpart, with appropriate adjustments, for calculating drag area.

(b) Determine a baseline  $C_d A$  value for a vehicle representing a production configuration without the aerodynamic

improvement. Repeat this testing and measure  $C_d A$  for a vehicle with the improved aerodynamic design.

(c) Use good engineering judgment to perform paired tests that accurately demonstrate the reduction in aerodynamic drag associated with the improved design.

(d) Measure  $C_d A$  in  $m^2$  to two decimal places. Calculate  $\Delta_d A$  by subtracting the drag area for the test vehicle from the drag area for the baseline vehicle.

■ 81. Amend § 1037.528 by:

■ a. Revising the introductory text and paragraphs (b) introductory text, (h)(5) introductory text, (h)(5)(iv), and (h)(6) introductory text;

■ b. Removing paragraph (h)(7);

■ c. Redesignating paragraphs (h)(8) through (12) as paragraphs (h)(7) through (11), respectively; and

■ d. Revising newly redesignated paragraph (h)(10).

The revisions read as follows:

**§ 1037.528 Coastdown procedures for calculating drag area ( $C_d A$ ).**

This section describes the reference method for calculating drag area,  $C_d A$ , for tractors using coastdown testing. Follow the provisions of Sections 1 through 9 of SAE J2263 (incorporated by reference, see § 1037.810), with the clarifications and exceptions described in this section. Several of the exceptions in this section are from SAE J1263 (incorporated by reference, see § 1037.810). The coastdown procedures in 40 CFR 1066.310 apply instead of the provisions of this section for Phase 1 tractors.

\* \* \* \* \*

(b) To determine  $C_d A$  values for a tractor-trailer combination using the manufacturer's tractor and a standard trailer. Prepare the tractor-trailer combination for testing as follows:

\* \* \* \* \*

(h) \* \* \*

(5) Calculate the drive-axle spin loss force at high and low speeds,  $F_{spin[speed]}$ , and determine  $\Delta F_{spin}$  as follows:

\* \* \* \* \*

(iv) Calculate  $\Delta F_{spin}$  using the following equation:

$$\Delta F_{spin} = F_{spinhi} - F_{spinlo}$$

Eq. 1037.528–10

*Example:*

$$\Delta F_{spin} = 129.7 - 52.7$$

$$\Delta F_{spin} = 77.0 \text{ N}$$

(6) Calculate the tire rolling resistance force at high and low speeds for steer, drive, and trailer axle positions,  $F_{TRR[speed,axle]}$ , and determine  $\Delta F_{TRR}$ , the rolling resistance difference between 65

mi/hr and 15 mi/hr, for each tire as follows:  
 \* \* \* \* \*

(10) Calculate drag area,  $C_dA$ , in  $m^2$  for each high-speed segment using the

following equation, expressed to at least three decimal places:

$$C_dA = \frac{2 \cdot (F_{hi} - F_{lo, pair} - \Delta F_{spin} - \Delta F_{TRR})}{(\bar{v}_{air, hi}^2 - \bar{v}_{air, lo, pair}^2)} \cdot \frac{R \cdot \bar{T}}{\bar{P}_{act}}$$

Eq. 1037.528–16

Where:

- $F_{hi}$  = road load force at high speed determined from Eq. 1037.528–7.
- $F_{lo, pair}$  = the average of  $F_{lo}$  values for a pair of opposite direction runs calculated as described in paragraph (h)(8) of this section.
- $\Delta F_{spin}$  = the difference in drive-axle spin loss force between high-speed and low-speed coastdown segments as described in paragraph (h)(5) of this section.

- $\Delta F_{TRR}$  = the difference in tire rolling resistance force between high-speed and low-speed coastdown segments as described in paragraph (h)(6) of this section.
- $\bar{v}_{air, lo, pair}^2$  = the average of  $\bar{v}_{air, lo}^2$  values for a pair of opposite direction runs calculated as described in paragraph (h)(8) of this section.
- $R$  = specific gas constant = 287.058 J/(kg·K).
- $\bar{T}$  = mean air temperature expressed to at least one decimal Place.

$\bar{P}_{act}$  = mean absolute air pressure expressed to at least one decimal place.

*Example:*  
 $F_{hi} = 4645.5$  N  
 $F_{lo, pair} = 1005.0$  N  
 $\Delta F_{spin} = 77.0$  N  
 $\Delta F_{TRR} = 187.4$  N  
 $\bar{v}_{air, hi}^2 = 933.4$   $m^2/s^2$   
 $\bar{v}_{air, lo, pair}^2 = 43.12$   $m^2/s^2$   
 $R = 287.058$  J/(kg·K)  
 $\bar{T} = 285.97$  K  
 $P_{act} = 101.727$  kPa = 101727 Pa

$$C_dA = \frac{2 \cdot (4640.5 - 1005.0 - 77.0 - 187.4)}{(933.4 - 43.12)} \cdot \frac{287.058 \cdot 285.97}{101727}$$

$$C_dA = 6.120 \text{ m}^2$$

\* \* \* \* \*

■ 82. Revise and republish § 1037.530 to read as follows:

**§ 1037.530 Wind tunnel procedures for calculating drag area ( $C_dA$ ).**

This section describes an alternate method for calculating drag area,  $C_dA$ , for tractors using wind tunnel testing.

(a) You may measure drag areas consistent with published SAE procedures as described in this section using any wind tunnel recognized by the Subsonic Aerodynamic Testing Association, subject to the provisions of § 1037.525. If your wind tunnel does not meet the specifications described in this section, you may ask us to approve it as an alternate method under § 1037.525(d). All wind tunnels and wind tunnel tests must meet the specifications described in SAE J1252 (incorporated by reference, see § 1037.810), with the following exceptions and additional provisions:

(1) The Overall Vehicle Reynolds number,  $Re^{\#_v}$ , must be at least  $1.0 \cdot 10^6$ . Tests for Reynolds effects described in Section 7.1 of SAE J1252 are not required.

(2) For full-scale wind tunnel testing, use good engineering judgment to select a trailer that is a reasonable representation of the tractor used for reference coastdown testing. For example, where your wind tunnel is not long enough to test the tractor with a

standard 53 foot box van, it may be appropriate to use a shorter box van. In such a case, the correlation developed using the shorter trailer would only be valid for testing with the shorter trailer.

(3) For reduced-scale wind tunnel testing, use a one-eighth or larger scale model of a tractor and trailer that is sufficient to simulate airflow through the radiator inlet grill and across an engine geometry that represents engines commonly used in your test vehicle.

(b) Open-throat wind tunnels must also meet the specifications of SAE J2071 (incorporated by reference, see § 1037.810).

(c) To determine  $C_{dA}$  values, perform wind tunnel testing with a tractor-trailer combination using the manufacturer's tractor and a standard trailer. Use a moving/rolling floor if the facility has one. For Phase 1 tractors, conduct the wind tunnel tests at a zero yaw angle. For Phase 2 and later vehicles, conduct the wind tunnel tests by measuring the drag area at yaw angles of  $+4.5^\circ$  and  $-4.5^\circ$  and calculating the average of those two values.

(d) In your request to use wind tunnel testing, describe how you meet all the specifications that apply under this section, using terminology consistent with SAE J1594 (incorporated by reference, see § 1037.810). If you request our approval to use wind tunnel testing even though you do not meet all the specifications of this section, describe

how your method nevertheless qualifies as an alternate method under § 1037.525(d) and include all the following information:

(1) Identify the name and location of the test facility for your wind tunnel method.

(2) Background and history of the wind tunnel.

(3) The wind tunnel's layout (with diagram), type, and construction (structural and material).

(4) The wind tunnel's design details: the type and material for corner turning vanes, air settling specification, mesh screen specification, air straightening method, tunnel volume, surface area, average duct area, and circuit length.

(5) Specifications related to the wind tunnel's flow quality: temperature control and uniformity, airflow quality, minimum airflow velocity, flow uniformity, angularity and stability, static pressure variation, turbulence intensity, airflow acceleration and deceleration times, test duration flow quality, and overall airflow quality achievement.

(6) Test/working section information: test section type (e.g., open, closed, adaptive wall) and shape (e.g., circular, square, oval), length, contraction ratio, maximum air velocity, maximum dynamic pressure, nozzle width and height, plenum dimensions and net volume, maximum allowed model scale, maximum model height above road,

strut movement rate (if applicable), model support, primary boundary layer slot, boundary layer elimination method, and photos and diagrams of the test section.

(7) Fan section description: fan type, diameter, power, maximum angular speed, maximum speed, support type, mechanical drive, and sectional total weight.

(8) Data acquisition and control (where applicable): acquisition type, motor control, tunnel control, model balance, model pressure measurement, wheel drag balances, wing/body panel balances, and model exhaust simulation.

(9) Moving ground plane or rolling road (if applicable): construction and material, yaw table and range, moving ground length and width, belt type, maximum belt speed, belt suction mechanism, platen instrumentation, temperature control, and steering.

(10) Facility correction factors and purpose.

■ 83. Amend § 1037.532 by revising the section heading, introductory text, and paragraphs (a) introductory text, (b), and (c) introductory text to read as follows:

**§ 1037.532 Using computational fluid dynamics for calculating drag area ( $C_{dA}$ ).**

This section describes an alternate method for calculating drag area,  $C_{dA}$ , for tractors using commercially available computational fluid dynamics (CFD) software.

(a) For Phase 2 and later vehicles, use SAE J2966 (incorporated by reference, see § 1037.810), with the following clarifications and exceptions:

\* \* \* \* \*

(b) For Phase 1 tractors, apply the procedures as specified in paragraphs (c) through (f) of this section. Paragraphs (c) through (f) apply for Phase 2 and later vehicles only as specified in paragraph (a) of this section.

(c) To determine  $C_{dA}$  values, perform CFD modeling based on a tractor-trailer combination using the manufacturer's tractor and a standard trailer. Perform all CFD modeling as follows:

\* \* \* \* \*

■ 84. Amend § 1037.534 by revising the introductory text and paragraph (c) introductory text to read as follows:

**§ 1037.534 Constant-speed procedure for calculating drag area ( $C_{dA}$ ).**

This section describes an alternate method for calculating drag area,  $C_{dA}$ ,

for tractors using constant-speed aerodynamic drag testing.

\* \* \* \* \*

(c) *Vehicle preparation.* Perform testing with a tractor-trailer combination using the manufacturer's tractor and a standard trailer. Prepare the tractor-trailer combination for testing as described in § 1037.528(b). Install measurement instruments meeting the requirements of 40 CFR part 1065, subpart C, that have been calibrated as described in 40 CFR part 1065, subpart D, as follows:

\* \* \* \* \*

■ 85. Amend § 1037.540 by revising the introductory text and paragraphs (c), (d)(4), and (f) to read as follows:

**§ 1037.540 Special procedures for testing vehicles with hybrid power take-off.**

This section describes optional procedures for quantifying the reduction in greenhouse gas emissions for vehicles as a result of running power take-off (PTO) devices with a hybrid energy delivery system. See 40 CFR 1036.545 for powertrain testing requirements that apply for drivetrain hybrid systems. The procedures are written to test the PTO by ensuring that the engine produces all of the energy with no net change in stored energy (charge-sustaining), and for plug-in hybrid electric vehicles, also allowing for drawing down the stored energy (charge-depleting). The full charge-sustaining test for the hybrid vehicle is from a fully charged rechargeable energy storage system (RESS) to a depleted RESS and then back to a fully charged RESS. You must include all hardware for the PTO system. You may ask us to modify the provisions of this section to allow testing hybrid vehicles that use a technology other than batteries for storing energy, consistent with good engineering judgment. For plug-in hybrid electric vehicles, use a utility factor to properly weight charge-sustaining and charge-depleting operation as described in paragraph (f)(3) of this section.

\* \* \* \* \*

(c) Measure PTO emissions from the fully warmed-up hybrid vehicle as follows:

(1) Perform the steps in paragraphs (b)(1) through (5) of this section.

(2) Prepare the vehicle for testing by operating it as needed to stabilize the RESS at a full state of charge (or equivalent for vehicles that use a

technology other than batteries for storing energy).

(i) For plug-in hybrid electric vehicles, we recommend charging the battery with an external electrical source.

(ii) For other vehicles, we recommend running back-to-back PTO tests until engine operation is initiated to charge the RESS. The RESS should be fully charged once engine operation stops. The ignition should remain in the "on" position.

(3) Turn the vehicle and PTO system off while the sampling system is being prepared.

(4) Turn the vehicle and PTO system on such that the PTO system is functional, whether it draws power from the engine or a battery.

(5) Operate the vehicle over one or both of the denormalized PTO duty cycles without turning the vehicle off, until the engine starts and then shuts down. This may require running multiple repeats of the PTO duty cycles. For non-PHEV systems that are not plug-in hybrid systems, the test cycle is completed once the engine shuts down. For plug-in hybrid systems, continue running until the PTO hybrid is running in a charge-sustaining mode such that the "End of Test" requirements defined in 40 CFR 1066.501(a)(3) are met. Measure emissions as described in paragraph (b)(7) of this section. Use good engineering judgment to minimize the variability in testing between the two types of vehicles.

(6) For plug-in hybrid electric vehicles, follow 40 CFR 1066.501(a)(3) to divide the test into charge-depleting and charge-sustaining operation.

(7) Apply cycle-validation criteria as described in paragraph (b)(8) of this section to both charge-sustaining and charge-depleting operation.

(d) \* \* \*

(4) Divide the total PTO operating time from paragraph (d)(3) of this section by a conversion factor of 0.0144 hr/mi for Phase 1 and 0.0217 hr/mi for Phase 2 and later to determine the equivalent distance driven. The conversion factors are based on estimates of average vehicle speed and PTO operating time as a percentage of total engine operating time; the Phase 2 and later conversion factor is calculated from an average speed of 27.1 mi/hr and PTO operation 37% of engine operating time, as follows:

$$\text{Factor} = \frac{37\%}{(100\% - 37\%) \cdot 27.1\text{mi/hr}} = 0.0217\text{hr/mi}$$

Eq. 1037.540–2a  
 \* \* \* \* \*

(f) For Phase 2 and later, calculate the delta PTO fuel results for input into GEM during vehicle certification as follows:

(1) Determine fuel consumption by calculating the mass of fuel for each test in grams,  $m_{fuelPTO}$ , without rounding, as described in 40 CFR 1036.540(d)(12) for both the conventional vehicle and the charge-sustaining and charge-depleting

portions of the test for the hybrid vehicle as applicable.

(2) Divide the fuel mass by the applicable distance determined in paragraph (d)(4) of this section and the appropriate standard payload as defined in § 1037.801 to determine the fuel-consumption rate in g/ton-mile.

(3) For plug-in hybrid electric vehicles calculate the utility factor weighted fuel-consumption rate in g/ton-mile, as follows:

(i) Determine the utility factor fraction for the PTO system from the table in appendix E of this part using interpolation based on the total time of the charge-depleting portion of the test as determined in paragraphs (c)(6) and (d)(3) of this section.

(ii) Weight the emissions from the charge-sustaining and charge-depleting portions of the test to determine the utility factor-weighted fuel mass,  $m_{fuelUF[cycle]plug-in}$ , using the following equation:

$$m_{fuelPTOplug-in} = \sum_{i=1}^N [m_{fuelPTOCDi} \cdot (UF_{DCDi} - UF_{DCDi-1})] + \sum_{j=1}^M [m_{fuelPTOCSj}] \cdot \frac{(1 - UF_{RCD})}{M}$$

Eq. 1037.540–3

Where:

$i$  = an indexing variable that represents one test interval.

$N$  = total number of charge-depleting test intervals.

$m_{fuelPTOCD}$  = total mass of fuel per ton-mile in the charge-depleting portion of the test for each test interval,  $i$ , starting from  $i = 1$ .

$UF_{DCDi}$  = utility factor fraction at time  $t_{CDi}$ , as determined in paragraph (f)(3)(i) of this section for each test interval,  $i$ , starting from  $i = 1$ .

$j$  = an indexing variable that represents one test interval.

$M$  = total number of charge-sustaining test intervals.

$m_{fuelPTOCS}$  = total mass of fuel per ton-mile in the charge-sustaining portion of the test for each test interval,  $j$ , starting from  $j = 1$ .

$UF_{RCD}$  = utility factor fraction at the full charge-depleting time,  $t_{CD}$ , as determined by interpolating the utility factor curve in appendix E to this part.  $t_{CD}$  is the sum of the time over  $N$  charge-depleting test intervals.

(4) Calculate the difference between the conventional PTO emissions result and the hybrid PTO emissions result for input into GEM.

\* \* \* \* \*

**§ 1037.550 [Removed]**

■ 86. Remove § 1037.550.

■ 87. Revise § 1037.551 to read as follows:

**§ 1037.551 Engine-based simulation of powertrain testing.**

The regulations in 40 CFR 1036.545 describe how to measure fuel consumption over specific duty cycles with an engine coupled to a transmission; 40 CFR 1036.545(a)(5) describes how to create equivalent duty cycles for repeating those same measurements with just the engine. This section describes how to perform this

engine testing to simulate the powertrain test. These engine-based measurements may be used for selective enforcement audits as described in § 1037.301, as long as the test engine's operation represents the engine operation observed in the powertrain test. If we use this approach for confirmatory testing, when making compliance determinations, we will consider the uncertainty associated with this approach relative to full powertrain testing. Use of this approach for engine SEAs is optional for engine manufacturers.

(a) Use the procedures of 40 CFR part 1065 to set up the engine, measure emissions, and record data. Measure individual parameters and emission constituents as described in this section. Measure  $NO_x$  emissions for each sampling period in grams. You may perform these measurements using a  $NO_x$  emission-measurement system that meets the requirements of 40 CFR part 1065, subpart J. Include these measured  $NO_x$  values any time you report to us your greenhouse gas emissions or fuel consumption values from testing under this section. If a system malfunction prevents you from measuring  $NO_x$  emissions during a test under this section but the test otherwise gives valid results, you may consider this a valid test and omit the  $NO_x$  emission measurements; however, we may require you to repeat the test if we determine that you inappropriately voided the test with respect to  $NO_x$  emission measurement. For hybrid powertrains, correct for the net energy change of the energy storage device as described in 40 CFR 1066.501(a)(3).

(b) Operate the engine over the applicable engine duty cycles corresponding to the vehicle cycles specified in § 1037.510(a)(2) for powertrain testing over the applicable

vehicle simulations described in 40 CFR 1036.545(j). Warm up the engine to prepare for the transient test or one of the highway cruise cycles by operating it one time over one of the simulations of the corresponding duty cycle. Warm up the engine to prepare for the idle test by operating it over a simulation of the 65-mi/hr highway cruise cycle for 600 seconds. Within 60 seconds after concluding the warm up cycle, start emission sampling while the engine operates over the duty cycle. You may perform any number of test runs directly in succession once the engine is warmed up. Perform cycle validation as described in 40 CFR 1065.514 for engine speed, torque, and power.

(c) Calculate the mass of fuel consumed as described in 40 CFR 1036.545(n) and (o). Correct each measured value for the test fuel's mass-specific net energy content as described in 40 CFR 1036.550. Use these corrected values to determine whether the engine's emission levels conform to the declared fuel-consumption rates from the powertrain test.

■ 88. Amend § 1037.555 by revising the introductory text and paragraph (h) to read as follows:

**§ 1037.555 Special procedures for testing Phase 1 hybrid systems.**

This section describes a powertrain testing procedure for simulating a chassis test with a pre-transmission or post-transmission hybrid system to perform A to B testing of Phase 1 vehicles. These procedures may also be used to perform A to B testing with non-hybrid systems. See 40 CFR 1036.545 for Phase 2 and later hybrid systems.

(h) Correct for the net energy change of the energy storage device as described in 40 CFR 1066.501(a)(3).

\* \* \* \* \*

■ 89. Amend § 1037.560 by revising paragraphs (e)(2) and (h)(1) to read as follows:

**§ 1037.560 Axle efficiency test.**

\* \* \* \* \*  
(e) \* \* \*  
(2) Maintain gear oil temperature at (81 to 83) °C. You may alternatively specify a lower range by shifting both temperatures down by the same amount for any or all test points. We will test your axle assembly using the same temperature range(s) you specify for your testing. If you use interpolation for mapping, use the same temperature range for all test points used in the interpolation. You may use an external gear oil conditioning system, as long as it does not affect measured values.

\* \* \* \* \*  
(h) \* \* \*  
(1) Test at least three axle assemblies within the same family representing at least the smallest axle ratio, the largest axle ratio, and an axle ratio closest to the arithmetic mean from the two other tested axle assemblies. Test each axle assembly as described in this section at the same speed and torque setpoints. Test all axle assemblies using the same gear oil temperature range for each setpoint as described in paragraph (e)(2) of this section.

■ 90. Amend § 1037.601 by revising paragraph (b) to read as follows:

**§ 1037.601 General compliance provisions.**

\* \* \* \* \*  
(b) Vehicles exempted from the applicable standards of 40 CFR part 86 or 1036 other than glider vehicles are exempt from the standards of this part without request. Similarly, vehicles other than glider vehicles are exempt without request if the installed engine is exempted from the applicable standards in 40 CFR part 86 or 1036.

■ 91. Amend § 1037.610 by revising paragraph (f)(2) to read as follows:

**§ 1037.610 Vehicles with off-cycle technologies.**

\* \* \* \* \*  
(f) \* \* \*  
(2) For model years 2021 and later, you may not rely on an approval for model years before 2021. You must separately request our approval before applying an improvement factor or credit under this section for Phase 2 and later vehicles, even if we approved an improvement factor or credit for similar vehicle models before model year 2021. Note that Phase 2 and later approval may carry over for multiple years.

■ 92. Revise and republish § 1037.615 to read as follows:

**§ 1037.615 Advanced technologies.**

(a) This section describes how to calculate emission credits for advanced technologies. You may calculate Phase 1 advanced technology credits through model year 2020 for hybrid vehicles with regenerative braking, vehicles equipped with Rankine-cycle engines, battery electric vehicles, and fuel cell electric vehicles. You may calculate Phase 2 advanced technology credits through model year 2026 for plug-in hybrid electric vehicles, battery electric vehicles, and fuel cell electric vehicles. You may calculate Phase 3 advanced technology credits for model year 2027 for plug-in hybrid electric vehicles, battery electric vehicles, and fuel cell electric vehicles. You may not generate credits for Phase 1 engine technologies for which the engines generate CO<sub>2</sub> credits under 40 CFR part 1036.

(b) Generate Phase 1 advanced-technology credits for vehicles other than battery electric vehicles as follows:

(1) Measure the effectiveness of the advanced system by chassis-testing a vehicle equipped with the advanced system and an equivalent conventional vehicle, or by testing the hybrid systems and the equivalent non-hybrid systems as described in § 1037.555. Test the vehicles as specified in subpart F of this part. For purposes of this paragraph (b), a conventional vehicle is considered to be equivalent if it has the same footprint (as defined in 40 CFR 86.1803), vehicle service class, aerodynamic drag, and other relevant factors not directly related to the hybrid powertrain. If you use § 1037.540 to quantify the benefits of a hybrid system for PTO operation, the conventional vehicle must have the same number of PTO circuits and have equivalent PTO power. If you do not produce an equivalent vehicle, you may create and test a prototype equivalent vehicle. The conventional vehicle is considered Vehicle A and the advanced vehicle is considered Vehicle B. We may specify an alternate cycle if your vehicle includes a power take-off.

(2) Calculate an improvement factor and g/ton-mile benefit using the following equations and parameters:

(i) Improvement Factor = [(Emission Rate A) – (Emission Rate B)]/(Emission Rate A).

(ii) g/ton-mile benefit = Improvement Factor × (GEM Result B).

(iii) Emission Rates A and B are the g/ton-mile CO<sub>2</sub> emission rates of the conventional and advanced vehicles, respectively, as measured under the test procedures specified in this section. GEM Result B is the g/ton-mile CO<sub>2</sub>

emission rate resulting from emission modeling of the advanced vehicle as specified in § 1037.520.

(3) If you apply an improvement factor to multiple vehicle configurations using the same advanced technology, use the vehicle configuration with the smallest potential reduction in greenhouse gas emissions resulting from the hybrid capability.

(4) Use the equation in § 1037.705 to convert the g/ton-mile benefit to emission credits (in Mg). Use the g/ton-mile benefit in place of the (Std – FEL) term.

(c) See § 1037.540 for special testing provisions related to Phase 1 vehicles equipped with hybrid power take-off units.

(d) For Phase 2 and Phase 3 plug-in hybrid electric vehicles and for fuel cells powered by any fuel other than hydrogen, calculate CO<sub>2</sub> credits using an FEL based on emission measurements from powertrain testing. Phase 2 and Phase 3 advanced technology credits do not apply for hybrid vehicles that have no plug-in capability.

(e) [Reserved]

(f) For battery electric vehicles and for fuel cell electric vehicles, calculate CO<sub>2</sub> credits using an FEL of 0 g/ton-mile. Note that these vehicles are subject to compression-ignition standards for CO<sub>2</sub>.

(g) As specified in subpart H of this part, advanced-technology credits generated from Phase 1 vehicles under this section may be used under this part outside of the averaging set in which they were generated, or they may be used under 40 CFR part 86, subpart S, or 40 CFR part 1036. Advanced-technology credits generated from Phase 2 and later vehicles are subject to the averaging-set restrictions that apply to other emission credits.

(h) You may certify using both provisions of this section and the off-cycle technology provisions of § 1037.610, provided you do not double count emission benefits.

**§ 1037.620 [Amended]**

■ 93. Amend § 1037.620 by removing paragraph (c) and redesignating paragraphs (d) through (f) as paragraphs (c) through (e), respectively.

■ 94. Amend § 1037.622 by revising the introductory text and paragraph (d)(5) to read as follows:

**§ 1037.622 Shipment of partially complete vehicles to secondary vehicle manufacturers.**

This section specifies how manufacturers may introduce partially complete vehicles into U.S. commerce (or in the case of certain custom vehicles, introduce complete vehicles

into U.S. commerce for modification by a small manufacturer). The provisions of this section are intended to accommodate normal business practices without compromising the effectiveness of certified emission controls. You may not use the provisions of this section to circumvent the intent of this part. For vehicles subject to both exhaust greenhouse gas and evaporative standards, the provisions of this part apply separately for each certificate.

\* \* \* \* \*

(d) \* \* \*  
(5) The provisions of this paragraph (d) may apply separately for vehicle greenhouse gas, evaporative, and refueling emission standards.

\* \* \* \* \*

■ 95. Amend § 1037.630 by revising paragraphs (a)(1)(iii) and (c) to read as follows:

§ 1037.630 Special purpose tractors.

(a) \* \* \*  
(1) \* \* \*

(iii) Model year 2020 and earlier tractors with a gross combination weight rating (GCWR) at or above 120,000 pounds. Note that Phase 2 and later tractors meeting the definition of *heavy-haul tractor* in § 1037.801 must be certified to the heavy-haul standards in § 1037.106 or § 1037.670.

\* \* \* \* \*

(c) *Production limit.* No manufacturer may produce more than 21,000 Phase 1 vehicles under this section in any consecutive three model year period. This means you may not exceed 6,000 in a given model year if the combined total for the previous two years was 15,000. The production limit applies with respect to all Class 7 and Class 8 Phase 1 tractors certified or exempted as vocational tractors. No production limit applies for tractors subject to Phase 2 and later standards.

\* \* \* \* \*

■ 96. Amend § 1037.631 by revising paragraph (a) introductory text to read as follows:

§ 1037.631 Exemption for vocational vehicles intended for off-road use.

\* \* \* \* \*

(a) *Qualifying criteria.* Vocational vehicles intended for off-road use are exempt without request, subject to the provisions of this section, if they are primarily designed to perform work off-road (such as in oil fields, mining, forests, or construction sites), and they meet at least one of the criteria of paragraph (a)(1) of this section and at least one of the criteria of paragraph (a)(2) of this section. See § 1037.105(h) for alternate Phase 2 and Phase 3

standards that apply for vehicles meeting only one of these sets of criteria.

\* \* \* \* \*

■ 97. Amend § 1037.635 by revising paragraph (b)(1) to read as follows:

§ 1037.635 Glider kits and glider vehicles.

\* \* \* \* \*

(b) \* \* \*  
(1) The engine must meet the greenhouse gas standards of 40 CFR part 1036 that apply for the engine model year corresponding to the vehicle's date of manufacture. For example, for a vehicle with a 2024 date of manufacture, the engine must meet the greenhouse gas standards that apply for model year 2024.

\* \* \* \* \*

■ 98. Amend § 1037.640 by revising the introductory text to read as follows:

§ 1037.640 Variable vehicle speed limiters.

This section specifies provisions that apply for vehicle speed limiters (VSLs) that you model under § 1037.520. This section is written to apply for tractors; however, you may use good engineering judgment to apply equivalent adjustments for Phase 2 and later vocational vehicles with vehicle speed limiters.

\* \* \* \* \*

■ 99. Amend § 1037.660 by revising paragraph (a) to read as follows:

§ 1037.660 Idle-reduction technologies.

\* \* \* \* \*

(a) *Minimum requirements.* Idle-reduction technologies must meet all the following requirements to be modeled under § 1037.520 except as specified in paragraphs (b) and (c) of this section:

(1) *Automatic engine shutdown (AES) systems.* The system must shut down the engine within a threshold inactivity period of 60 seconds or less for vocational vehicles and 300 seconds or less for tractors when all the following conditions are met:

(i) The transmission is set to park, or the transmission is in neutral with the parking brake engaged. This is "parked idle."

(ii) The operator has not reset the system timer within the specified threshold inactivity period by changing the position of the accelerator, brake, or clutch pedal; or by resetting the system timer with some other mechanism we approve.

(iii) You may identify systems as "tamper-resistant" if you make no provision for vehicle owners, dealers, or other service outlets to adjust the threshold inactivity period.

(iv) For Phase 2 and later tractors, you may identify AES systems as "adjustable" if, before delivering to the ultimate purchaser, you enable authorized dealers to modify the vehicle in a way that disables the AES system or makes the threshold inactivity period longer than 300 seconds. However, the vehicle may not be delivered to the ultimate purchaser with the AES system disabled or the threshold inactivity period set longer than 300 seconds. You may allow dealers or repair facilities to make such modifications; this might involve password protection for electronic controls, or special tools that only you provide. Any dealers making any modifications before delivery to the ultimate purchaser must notify you, and you must account for such modifications in your production and ABT reports after the end of the model year. Dealers failing to provide prompt notification are in violation of the tampering prohibition of 40 CFR 1068.101(b)(1). Dealer notifications are deemed to be submissions to EPA. Note that these adjustments may not be made if the AES system was not "adjustable" when first delivered to the ultimate purchaser.

(v) For vocational vehicles, you may use the provisions of § 1037.610 to apply for an appropriate partial emission reduction for AES systems you identify as "adjustable."

(2) *Neutral idle.* Phase 2 and later vehicles with hydrokinetic torque converters paired with automatic transmissions qualify for neutral-idle credit in GEM modeling if the transmission reduces torque equivalent to shifting into neutral throughout the interval during which the vehicle's brake pedal is depressed and the vehicle is at a zero-speed condition (beginning within five seconds of the vehicle reaching zero speed with the brake depressed). If a vehicle reduces torque partially but not enough to be equivalent to shifting to neutral, you may use the provisions of § 1037.610(g) to apply for an appropriate partial emission reduction; this may involve A to B testing with the powertrain test procedure in 40 CFR 1036.545 or the spin-loss portion of the transmission efficiency test in § 1037.565.

(3) *Stop-start.* Phase 2 and later vocational vehicles qualify for stop-start reduction in GEM modeling if the engine shuts down no more than 5 seconds after the vehicle's brake pedal is depressed when the vehicle is at a zero-speed condition.

\* \* \* \* \*

■ 100. Revise and republish § 1037.665 to read as follows:



**§ 1037.665 Production and in-use tractor testing.**

We may require manufacturers with annual U.S.-directed production volumes of greater than 20,000 tractors to perform testing as described in this section. Tractors may be new or used.

(a) Test model year 2021 and later tractors as follows:

(1) Each calendar year, we may require you to select for testing three sleeper cabs and two day cabs certified to Phase 1 or Phase 2 standards. If we do not identify certain vehicle configurations for your testing, select models that you project to be among your 12 highest-selling vehicle configurations for the given year.

(2) Set up the tractors on a chassis dynamometer and operate them over all applicable duty cycles from § 1037.510(a)(3). You may use emission-measurement systems meeting the

specifications of 40 CFR part 1065, subpart J. Calculate coefficients for the road-load force equation as described in Section 10 of SAE J1263 or Section 11 of SAE J2263 (both incorporated by reference, see § 1037.810). Use standard payload. Measure emissions of NO<sub>x</sub>, PM, CO, NMHC, CO<sub>2</sub>, CH<sub>4</sub>, and N<sub>2</sub>O. Determine emission levels in g/ton-mile.

(b) Send us an annual report with your test results for each duty cycle and the corresponding GEM results. Send the report by the next October 1 after the year we select the vehicles for testing, or a later date that we approve. We may make your test data publicly available.

(c) We may approve your request to perform alternative testing that will provide equivalent or better information compared to the specified testing. For example, we may allow you to provide CO<sub>2</sub> data from in-use operation or from manufacturer-run on-road testing as

long as it allows for reasonable year-to-year comparisons and includes testing from production vehicles. We may also direct you to do less testing than we specify in this section.

(d) Greenhouse gas standards do not apply with respect to testing under this section. Note however that NTE standards apply for any qualifying operation that occurs during the testing in the same way that it would during any other in-use testing.

■ 101. Amend § 1037.670 by revising paragraph (a) to read as follows:

**§ 1037.670 Optional CO<sub>2</sub> emission standards for tractors at or above 120,000 pounds GCWR.**

(a) You may certify model year 2026 and earlier tractors at or above 120,000 pounds GCWR to the following CO<sub>2</sub> standards instead of the Phase 2 CO<sub>2</sub> standards of § 1037.106:

TABLE 1 OF PARAGRAPH (a) OF § 1037.670—OPTIONAL CO<sub>2</sub> STANDARDS FOR TRACTORS ABOVE 120,000 POUNDS GCWR  
 [g/ton-mile]<sup>a</sup>

Subcategory	Model years 2021–2023	Model years 2024–2026
Heavy Class 8 Low-Roof Day Cab .....	53.5	50.8
Heavy Class 8 Low-Roof Sleeper Cab .....	47.1	44.5
Heavy Class 8 Mid-Roof Day Cab .....	55.6	52.8
Heavy Class 8 Mid-Roof Sleeper Cab .....	49.6	46.9
Heavy Class 8 High-Roof Day Cab .....	54.5	51.4
Heavy Class 8 High-Roof Sleeper Cab .....	47.1	44.2

<sup>a</sup>Note that these standards are not directly comparable to the standards for Heavy-Haul Tractors in § 1037.106 because GEM handles aerodynamic performance differently for the two sets of standards.

\* \* \* \* \*

■ 102. Amend § 1037.701 by revising paragraphs (a), (f), and (h) to read as follows:

**§ 1037.701 General provisions.**

(a) You may average, bank, and trade emission credits for purposes of certification as described in this subpart and in subpart B of this part to show compliance with the standards of §§ 1037.105 and 1037.106. Note that § 1037.105(h) specifies standards involving limited or no use of emission credits under this subpart. Participation in this program is voluntary.

\* \* \* \* \*

(f) Emission credits may be used in the model year they are generated. Where we allow it, surplus emission credits may be banked for future model years. Surplus emission credits may sometimes be used for past model years, as described in § 1037.745. You may not apply banked or traded credits in a given model year until you have used all available credits through averaging to

resolve credit balances for that model year.

\* \* \* \* \*

(h) See § 1037.740 for special credit provisions that apply for credits generated under 40 CFR 86.1819–14(k)(7) or 1036.615 or § 1037.615.

\* \* \* \* \*

■ 103. Revise and republish § 1037.705 to read as follows:

**§ 1037.705 Generating and calculating CO<sub>2</sub> emission credits.**

(a) The provisions of this section apply separately for calculating CO<sub>2</sub> emission credits for each pollutant.

(b) For each participating family or subfamily, calculate positive or negative emission credits relative to the otherwise applicable emission standard. Calculate positive emission credits for a family or subfamily that has an FEL below the standard. Calculate negative emission credits for a family or subfamily that has an FEL above the standard. Sum your positive and negative credits for the model year before rounding. Round the sum of

emission credits to the nearest megagram (Mg), using consistent units with the following equation:

$$Emission\ credits\ (Mg) = (Std - FEL) \cdot PL \cdot Volume \cdot UL \cdot 10^{-6}$$

Eq. 1037.705–1

Where:

*Std* = the emission standard associated with the specific regulatory subcategory (g/ton-mile).

*FEL* = the family emission limit for the vehicle subfamily (g/ton-mile).

*PL* = standard payload, in tons.

*Volume* = U.S.-directed production volume of the vehicle subfamily, subject to the exclusions described in paragraph (c) of this section. For example, if you produce three configurations with the same FEL, the subfamily production volume would be the sum of the production volumes for these three configurations.

*UL* = useful life of the vehicle, in miles, as described in §§ 1037.105 and 1037.106.

(c) Compliance with the requirements of this subpart is determined at the end of the model year by calculating emission credits based on actual

production volumes, excluding any of the following vehicles:

(1) Vehicles that you do not certify to the CO<sub>2</sub> standards of this part because they are permanently exempted under subpart G of this part or under 40 CFR part 1068.

(2) Exported vehicles even if they are certified under this part and labeled accordingly.

(3) Vehicles not subject to the requirements of this part, such as those excluded under § 1037.5.

(4) Any other vehicles, where we indicate elsewhere in this part that they are not to be included in the calculations of this subpart.

■ 104. Amend § 1037.710 by revising paragraph (c) to read as follows:

**§ 1037.710 Averaging.**

\* \* \* \* \*

(c) If you certify a vehicle family to an FEL that exceeds the otherwise applicable standard, you must obtain enough emission credits to offset the vehicle family's deficit by the due date for the final report required in § 1037.730. The emission credits used to address the deficit may come from your other vehicle families that generate emission credits in the same model year (or from later model years as specified in § 1037.745), from emission credits you have banked from previous model years, or from emission credits generated in the same or previous model years that you obtained through trading.

■ 105. Amend § 1037.715 by revising paragraph (a) to read as follows:

**§ 1037.715 Banking.**

(a) Banking is the retention of surplus emission credits by the manufacturer generating the emission credits for use in future model years for averaging or trading.

\* \* \* \* \*

■ 106. Amend § 1037.720 by revising paragraph (a) to read as follows:

**§ 1037.720 Trading.**

(a) Trading is the exchange of emission credits between manufacturers, or the transfer of credits to another party to retire them. You may use traded emission credits for averaging, banking, or further trading transactions. Traded emission credits remain subject to the averaging-set restrictions based on the averaging set in which they were generated.

\* \* \* \* \*

■ 107. Amend § 1037.730 by revising paragraphs (b)(4) and (f)(1) to read as follows:

**§ 1037.730 ABT reports.**

\* \* \* \* \*

(b) \* \* \*

(4) The projected and actual production volumes for the model year for calculating emission credits. If you changed an FEL during the model year, identify the actual production volume associated with each FEL.

\* \* \* \* \*

(f) \* \* \*

(1) If you notify us by the deadline for submitting the final report that errors mistakenly decreased your balance of emission credits, you may correct the errors and recalculate the balance of emission credits. If you notify us that errors mistakenly decreased your balance of emission credits after the deadline for submitting the final report, you may correct the errors and recalculate the balance of emission credits after applying a 10 percent discount to the credit correction, but only if you notify us within 24 months after the deadline for submitting the final report. If you report a negative balance of emission credits, we may disallow corrections under this paragraph (f)(1).

\* \* \* \* \*

■ 108. Amend § 1037.740 by revising paragraphs (a), (b)(1) introductory text, and (b)(2) to read as follows:

**§ 1037.740 Restrictions for using emission credits.**

\* \* \* \* \*

(a) *Averaging sets.* Except as specified in § 1037.105(h) and paragraph (b) of this section, emission credits may be exchanged only within an averaging set. The following principal averaging sets apply for vehicles certified to the standards of this part involving emission credits as described in this subpart:

(1) Light HDV.

(2) Medium HDV.

(3) Heavy HDV.

(4) Note that other separate averaging sets also apply for emission credits not related to this part. For example, vehicles certified to the greenhouse gas standards of 40 CFR part 86, subpart S, comprise a single averaging set. Separate averaging sets also apply for engines under 40 CFR part 1036, including engines used in vehicles subject to this subpart.

(b) \* \* \*

(1) Credits generated from Phase 1 vehicles may be used for any of the averaging sets identified in paragraph (a) of this section; you may also use those credits to demonstrate compliance with the CO<sub>2</sub> emission standards in 40 CFR part 86, subpart S, and 40 CFR part 1036. Similarly, you may use Phase 1 advanced-technology credits generated

under 40 CFR 86.1819–14(k)(7) or 1036.615 to demonstrate compliance with the CO<sub>2</sub> standards in this part. The maximum amount of advanced-technology credits generated from Phase 1 vehicles that you may bring into each of the following service class groups is 60,000 Mg per model year:

\* \* \* \* \*

(2) Credits generated from Phase 2 and later vehicles are subject to the averaging-set restrictions that apply to other emission credits.

\* \* \* \* \*

■ 109. Amend § 1037.745 by revising paragraph (a) to read as follows:

**§ 1037.745 End-of-year CO<sub>2</sub> credit deficits.**

\* \* \* \* \*

(a) Your certificate for a vehicle family for which you do not have sufficient CO<sub>2</sub> credits will not be void if you remedy the deficit with surplus credits within three model years. For example, if you have a credit deficit of 500 Mg for a vehicle family at the end of model year 2015, you must generate (or otherwise obtain) a surplus of at least 500 Mg in that same averaging set by the end of model year 2018.

\* \* \* \* \*

■ 110. Amend § 1037.801 by:

- a. Adding a definition of “Battery electric vehicle” in alphabetical order;
- b. Removing the definition of “Box van”;
- c. Revising the definition of “Class”;
- d. Removing the definitions of “Container chassis”, “Electric vehicle”, and “Flatbed trailer”;
- e. Adding a definition of “Fuel cell electric vehicle” in alphabetical order;
- f. Revising the definitions of “Greenhouse gas Emissions Model (GEM)”, “Heavy-duty vehicle”, and “Heavy-haul tractor”;
- g. Adding a definition of “Hybrid” in alphabetical order;
- h. Removing the definitions of “Hybrid engine or hybrid powertrain” and “Hybrid vehicle”;
- i. Revising the definitions of “Light-duty truck”, “Light-duty vehicle”, “Low rolling resistance tire”, “Manufacturer”, and “Model year”;
- j. Adding a definition of “Neat” in alphabetical order;
- k. Revising the definitions of “Neutral coasting”, “Phase 1”, and “Phase 2”;
- l. Adding definitions of “Phase 3” and “Plug-in hybrid electric vehicle” in alphabetical order;
- m. Revising the definitions of “Preliminary approval”, “Small manufacturer”, and “Standard payload”;
- n. Removing the definition of “Standard tractor”;

- o. Adding a definition of “State of certified energy (SOCE)” in alphabetical order;
- p. Removing the definitions of “Tank trailer” and “Tonne”;
- q. Adding a definition of “Ton” in alphabetical order;
- r. Revising the definitions of “Trailer” and “U.S.-directed production volume”;
- s. Adding a definition of “Usable battery energy (UBE)” in alphabetical order; and
- t. Revising the definition of “Vehicle”.

The additions and revisions read as follows:

**§ 1037.801 Definitions.**

\* \* \* \* \*

*Battery electric vehicle* means a motor vehicle powered solely by an electric motor where energy for the motor is supplied by one or more batteries that receive power from an external source of electricity. Note that this definition does not include hybrid vehicles or plug-in hybrid electric vehicles.

\* \* \* \* \*

*Class* means relating to GVWR classes, as follows:

(1) *Class 2b* means relating to heavy-duty motor vehicles at or below 10,000 pounds GVWR.

(2) *Class 3* means relating to heavy-duty motor vehicles above 10,000 pounds GVWR but at or below 14,000 pounds GVWR.

(3) *Class 4* means relating to heavy-duty motor vehicles above 14,000 pounds GVWR but at or below 16,000 pounds GVWR.

(4) *Class 5* means relating to heavy-duty motor vehicles above 16,000 pounds GVWR but at or below 19,500 pounds GVWR.

(5) *Class 6* means relating to heavy-duty motor vehicles above 19,500 pounds GVWR but at or below 26,000 pounds GVWR.

(6) *Class 7* means relating to heavy-duty motor vehicles above 26,000 pounds GVWR but at or below 33,000 pounds GVWR.

(7) *Class 8* means relating to heavy-duty motor vehicles above 33,000 pounds GVWR.

\* \* \* \* \*

*Fuel cell electric vehicle* means a motor vehicle powered solely by an electric motor where energy for the motor is supplied by hydrogen fuel cells. Fuel cell electric vehicles may include energy storage from the fuel cells or from regenerative braking in a battery.

\* \* \* \* \*

*Greenhouse gas Emissions Model (GEM)* means the GEM simulation tool

described in § 1037.520 (incorporated by reference, see § 1037.810).

\* \* \* \* \*

*Heavy-duty vehicle* means any motor vehicle that has a GVWR above 8,500 pounds. An incomplete vehicle is also a heavy-duty vehicle if it has a curb weight above 6,000 pounds or a basic square frontal area greater than 45 square feet.

*Heavy-haul tractor* means a tractor with GCWR greater than or equal to 120,000 pounds. A heavy-haul tractor is not a vocational tractor in Phase 2 and later.

\* \* \* \* \*

*Hybrid* has the meaning given in 40 CFR 1036.801. Note that a hybrid vehicle is a vehicle with a hybrid engine or other hybrid powertrain. This includes plug-in hybrid electric vehicles.

\* \* \* \* \*

*Light-duty truck* has the meaning given in 40 CFR 86.1803-01.

*Light-duty vehicle* has the meaning given in 40 CFR 86.1803-01.

\* \* \* \* \*

*Low rolling resistance tire* means a tire on a vocational vehicle with a TRRL at or below of 7.7 N/kN, a steer tire on a tractor with a TRRL at or below 7.7 N/kN, a drive tire on a tractor with a TRRL at or below 8.1 N/kN.

\* \* \* \* \*

*Manufacturer* has the meaning given in section 216(1) of the Act. In general, this term includes any person who manufactures or assembles a vehicle (including an incomplete vehicle) for sale in the United States or otherwise introduces a new motor vehicle into commerce in the United States. This includes importers who import vehicles for resale, entities that manufacture glider kits, and entities that assemble glider vehicles.

\* \* \* \* \*

*Model year* means one of the following for compliance with this part. Note that manufacturers may have other model year designations for the same vehicle for compliance with other requirements or for other purposes:

(1) For vehicles with a date of manufacture on or after January 1, 2021, *model year* means the manufacturer’s annual new model production period based on the vehicle’s date of manufacture, where the model year is the calendar year corresponding to the date of manufacture, except as follows:

(i) The vehicle’s model year may be designated as the year before the calendar year corresponding to the date of manufacture if the engine’s model year is also from an earlier year. You

may ask us to extend your prior model year certificate to include such vehicles. Note that § 1037.601(a)(2) limits the extent to which vehicle manufacturers may install engines built in earlier calendar years.

(ii) The vehicle’s model year may be designated as the year after the calendar year corresponding to the vehicle’s date of manufacture. For example, a manufacturer may produce a new vehicle by installing the engine in December 2023 and designating it as a model year 2024 vehicle.

(2) For Phase 1 vehicles with a date of manufacture before January 1, 2021, *model year* means the manufacturer’s annual new model production period, except as restricted under this definition and 40 CFR part 85, subpart X. It must include January 1 of the calendar year for which the model year is named, may not begin before January 2 of the previous calendar year, and it must end by December 31 of the named calendar year. The model year may be set to match the calendar year corresponding to the date of manufacture.

(i) The manufacturer who holds the certificate of conformity for the vehicle must assign the model year based on the date when its manufacturing operations are completed relative to its annual model year period. In unusual circumstances where completion of your assembly is delayed, we may allow you to assign a model year one year earlier, provided it does not affect which regulatory requirements will apply.

(ii) Unless a vehicle is being shipped to a secondary vehicle manufacturer that will hold the certificate of conformity, the model year must be assigned prior to introduction of the vehicle into U.S. commerce. The certifying manufacturer must redesignate the model year if it does not complete its manufacturing operations within the originally identified model year. A vehicle introduced into U.S. commerce without a model year is deemed to have a model year equal to the calendar year of its introduction into U.S. commerce unless the certifying manufacturer assigns a later date.

\* \* \* \* \*

*Neat* has the meaning given in 40 CFR 1065.1001.

*Neutral coasting* means a vehicle technology that automatically puts the transmission in neutral when the when operator demand is zero while the vehicle is in motion, such as driving downhill.

\* \* \* \* \*

*Phase 1* means relating to the Phase 1 standards specified in §§ 1037.105 and

1037.106. For example, a vehicle subject to the Phase 1 standards is a Phase 1 vehicle.

Phase 2 means relating to the Phase 2 standards specified in §§ 1037.105 and 1037.106.

Phase 3 means relating to the Phase 3 standards specified in §§ 1037.105 and 1037.106.

\* \* \* \* \*

Plug-in hybrid electric vehicle means a hybrid vehicle that has the capability to charge one or more batteries from an external source of electricity while the vehicle is parked.

\* \* \* \* \*

Preliminary approval means approval granted by an authorized EPA representative prior to submission of an application for certification, consistent with the provisions of § 1037.210.

\* \* \* \* \*

Small manufacturer means a manufacturer meeting the small business criteria specified in 13 CFR 121.201 for heavy-duty truck manufacturing (NAICS code 336120). The employee limit applies to the total number employees for all affiliated companies (as defined in 40 CFR 1068.30).

\* \* \* \* \*

Standard payload means the payload assumed for each vehicle, in tons, for modeling and calculating emission credits, as follows:

- (1) For vocational vehicles:
  - (i) 2.85 tons for Light HDV.
  - (ii) 5.6 tons for Medium HDV.
  - (iii) 7.5 tons for Heavy HDV.
- (2) For tractors:
  - (i) 12.5 tons for Class 7.
  - (ii) 19 tons for Class 8, other than heavy-haul tractors.
  - (iii) 43 tons for heavy-haul tractors.

\* \* \* \* \*

State of certified energy (SOCE) means the measured or onboard UBE performance at a specific point in its lifetime, expressed as a percentage of the certified usable battery energy.

\* \* \* \* \*

Ton means a short ton, which is exactly 2000 pounds.

\* \* \* \* \*

Trailer means a piece of equipment designed for carrying cargo and for being drawn by a tractor when coupled to the tractor's fifth wheel.

\* \* \* \* \*

U.S.-directed production volume means the number of vehicle units, subject to the requirements of this part, produced by a manufacturer for which the manufacturer has a reasonable assurance that sale was or will be made to ultimate purchasers in the United States.

Usable battery energy (UBE) means the energy the battery supplies from the start of the certification test procedure until the applicable break-off criterion. This part depends on certified and aged values of UBE to set battery monitoring requirements as described in § 1037.115(f).

\* \* \* \* \*

Vehicle means equipment intended for use on highways that meets at least one of the criteria of paragraph (1) of this definition, as follows:

(1) The following equipment are vehicles:

(i) A piece of equipment that is intended for self-propelled use on highways becomes a vehicle when it includes at least an engine, a transmission, and a frame. (Note: For purposes of this definition, any electrical, mechanical, and/or hydraulic devices attached to engines for the purpose of powering wheels are considered to be transmissions.)

(ii) A piece of equipment that is intended for self-propelled use on highways becomes a vehicle when it includes a passenger compartment attached to a frame with one or more axles.

(2) Vehicles may be complete or incomplete vehicles as follows:

(i) A complete vehicle is a functioning vehicle that has the primary load carrying device or container (or equivalent equipment) attached when it is first sold as a vehicle. Examples of equivalent equipment would include fifth wheel trailer hitches, firefighting equipment, and utility booms.

(ii) An incomplete vehicle is a vehicle that is not a complete vehicle. Incomplete vehicles may also be cab-complete vehicles. This may include vehicles sold to secondary vehicle manufacturers.

(iii) You may ask us to allow you to certify a vehicle as incomplete if you manufacture the engines and sell the unassembled chassis components, as long as you do not produce and sell the body components necessary to complete the vehicle.

\* \* \* \* \*

- 111. Amend § 1037.805 by:
  - a. Revising the introductory text; and
  - b. In table 5 to paragraph (e), removing the entries for "ECM", "FE", "FTP", "LLC", "PHEV", and "SET".

The revision reads as follows:

**§ 1037.805 Symbols, abbreviations, and acronyms.**

The procedures in this part generally follow either the International System of Units (SI) or the United States customary units, as detailed in NIST

Special Publication 811 (incorporated by reference, see § 1037.810). See 40 CFR 1065.20 for specific provisions related to these conventions. This section summarizes the way we use symbols, units of measure, and other abbreviations.

\* \* \* \* \*

- 112. Amend § 1037.810 by:
    - a. Revising paragraph (c)(2);
    - b. Removing paragraph (c)(9);
    - c. Redesignating paragraph (c)(10) as paragraph (c)(9); and
    - d. Revising paragraph (d).
- The revisions read as follows:

**§ 1037.810 Incorporation by reference.**

\* \* \* \* \*

(c) \* \* \*  
(2) SAE J1252 JUL2012, SAE Wind Tunnel Test Procedure for Trucks and Buses, Revised July 2012, ("SAE J1252"); IBR approved for §§ 1037.525(b) and (c); 1037.530(a).

\* \* \* \* \*

(d) U.S. EPA, Office of Air and Radiation, 2565 Plymouth Road, Ann Arbor, MI 48105; [www.epa.gov](http://www.epa.gov); [complianceinfo@epa.gov](mailto:complianceinfo@epa.gov).

(1) Greenhouse gas Emissions Model (GEM), Version 2.0.1, September 2012 ("GEM version 2.0.1"); IBR approved for § 1037.520.

(2) Greenhouse gas Emissions Model (GEM) Phase 2, Version 3.0, July 2016 ("GEM Phase 2, Version 3.0"); IBR approved for § 1037.150(x).

(3) Greenhouse gas Emissions Model (GEM) Phase 2, Version 3.5.1, November 2020 ("GEM Phase 2, Version 3.5.1"); IBR approved for § 1037.150(x).

(4) Greenhouse gas Emissions Model (GEM) Phase 2, Version 4.0, April 2022 ("GEM Phase 2, Version 4.0"); IBR approved for §§ 1037.150(x); 1037.520.

(5) GEM's MATLAB/Simulink Hardware-in-Loop model, Version 3.8, December 2020 ("GEM HIL model 3.8"); IBR approved for § 1037.150(x).

- 113. Revise appendix C to part 1037 to read as follows:

**Appendix C to Part 1037—Emission Control Identifiers**

This appendix identifies abbreviations for emission control information labels, as required under § 1037.135.

**Vehicle Speed Limiters**

- VSL—Vehicle speed limiter
- VSLs—"Soft-top" vehicle speed limiter
- VSLE—Expiring vehicle speed limiter
- VSLD—Vehicle speed limiter with both "soft-top" and expiration

**Idle Reduction Technology**

- IRT5—Engine shutdown after 5 minutes or less of idling
- IRTE—Expiring engine shutdown

**Tires**

- LRRR—Low rolling resistance tires (all)
- LRRD—Low rolling resistance tires (drive)
- LRRS—Low rolling resistance tires (steer)

**Aerodynamic Components**

- ATS—Aerodynamic side skirt and/or fuel tank fairing
- ARF—Aerodynamic roof fairing
- ARFR—Adjustable height aerodynamic roof fairing
- TGR—Gap reducing tractor fairing (tractor to trailer gap)

**Other Components**

- ADVH—Vehicle includes advanced hybrid technology components
- ADVO—Vehicle includes other advanced-technology components (i.e., non-hybrid system)
- INV—Vehicle includes innovative (off-cycle) technology components
- ATI—Automatic tire inflation system
- TPMS—Tire pressure monitoring system

■ 114. Revise appendix D to part 1037 to read as follows:

**Appendix D to Part 1037—Heavy-Duty Grade Profile for Steady-State Test Cycles**

The following table identifies a grade profile for operating vehicles over the highway cruise cycles specified in subpart F of this part. Determine intermediate values by linear interpolation.

Distance (m)	Grade (%)	Distance (m)	Grade (%)
0	0	7544	2.57
402	0	7620	2.14
804	0.5	7746	1.66
1206	0	7870	1.29
1210	0	7956	1.09
1222	-0.10	8130	0.77
1234	0	8270	0.58
1244	0	8462	0.38
1294	0.36	8684	0.17
1344	0	8776	0.10
1354	0	8860	0
1408	-0.28	8904	0
1504	-1.04	9010	-0.38
1600	-0.28	9070	-0.69
1654	0	9254	-2.13
1666	0	9438	-0.69
1792	0.39	9498	-0.38
1860	0.66	9604	0
1936	1.15	9616	0
2098	2.44	9664	0.26
2260	1.15	9718	0.70
2336	0.66	9772	0.26
2404	0.39	9820	0
2530	0	9830	0
2548	0	9898	-0.34
2732	-0.46	10024	-1.33
2800	-0.69	10150	-0.34
2880	-1.08	10218	0
2948	-1.53	10228	0
3100	-2.75	10316	0.37
3252	-1.53	10370	0.70
3320	-1.08	10514	1.85
3400	-0.69	10658	0.70
3468	-0.46	10712	0.37
3652	0	10800	0
3666	0	10812	0
3742	0.35	10900	-0.37
3818	0.90	10954	-0.7
3904	1.59	11098	-1.85
3990	0.90	11242	-0.70
4066	0.35	11296	-0.37
4142	0	11384	0
4158	0	11394	0
4224	-0.10	11462	0.34
4496	-0.69	11588	1.33
4578	-0.97	11714	0.34
4664	-1.36	11782	0
4732	-1.78	11792	0
4916	-3.23	11840	-0.26
5100	-1.78	11894	-0.70
5168	-1.36	11948	-0.26
5254	-0.97	11996	0
5336	-0.69	12008	0
5608	-0.10	12114	0.38
5674	0	12174	0.69
5724	0	12358	2.13
5808	0.10	12542	0.69
5900	0.17	12602	0.38
6122	0.38	12708	0
6314	0.58	12752	0
6454	0.77	12836	-0.10
6628	1.09	12928	-0.17
6714	1.29	13150	-0.38
6838	1.66	13342	-0.58
6964	2.14	13482	-0.77
7040	2.57	13656	-1.09
7112	3.00	13742	-1.29
7164	3.27	13866	-1.66
7202	3.69	13992	-2.14
7292	5.01	14068	-2.57
7382	3.69	14140	-3.00
7420	3.27	14192	-3.27
7472	3.00	14230	-3.69
7544	2.57	14320	-5.01
7620	2.14	14410	-3.69
7746	1.66	14448	-3.27
7870	1.29	14500	-3.00
7956	1.09	14572	-2.57
8130	0.77	14648	-2.14
8270	0.58	14774	-1.66
8462	0.38	14898	-1.29
8684	0.17	14984	-1.09
8776	0.10	15158	-0.77
8860	0	15298	-0.58
8904	0	15490	-0.38
9010	-0.38	15712	-0.17
9070	-0.69	15804	-0.10
9254	-2.13	15888	0
9438	-0.69	15938	0
9498	-0.38	16004	0.10
9604	0	16276	0.69
9616	0	16358	0.97
9664	0.26	16444	1.36
9718	0.70	16512	1.78
9772	0.26	16696	3.23
9820	0	16880	1.78
9830	0	16948	1.36
9898	-0.34	17034	0.97
10024	-1.33	17116	0.69
10150	-0.34	17388	0.10
10218	0	17454	0
10228	0	17470	0
10316	0.37	17546	-0.35
10370	0.70	17622	-0.90
10514	1.85	17708	-1.59
10658	0.70	17794	-0.90
10712	0.37	17870	-0.35
10800	0	17946	0
10812	0	17960	0

Distance (m)	Grade (%)
18144	0.46
18212	0.69
18292	1.08
18360	1.53
18512	2.75
18664	1.53
18732	1.08
18812	0.69
18880	0.46
19064	0
19082	0
19208	-0.39
19276	-0.66
19352	-1.15
19514	-2.44
19676	-1.15
19752	-0.66
19820	-0.39
19946	0
19958	0
20012	0.28
20108	1.04
20204	0.28
20258	0
20268	0
20318	-0.36
20368	0
20378	0
20390	0.10
20402	0
20406	0
20808	-0.50
21210	0
21612	0

**PART 1039—CONTROL OF EMISSIONS FROM NEW AND IN-USE NONROAD COMPRESSION-IGNITION ENGINES**

■ 115. The authority citation for part 1039 continues to read as follows:

Authority: 42 U.S.C. 7401–7671q.

■ 116. Amend § 1039.705 by revising paragraph (b) to read as follows:

**§ 1039.705 How do I generate and calculate emission credits?**

(b) For each participating family, calculate positive or negative emission credits relative to the otherwise applicable emission standard. Calculate positive emission credits for a family that has an FEL below the standard. Calculate negative emission credits for a family that has an FEL above the standard. Sum your positive and negative credits for the model year before rounding. Round the sum of emission credits to the nearest kilogram (kg), using consistent units throughout the following equation:

$$\text{Emission credits (kg)} = (\text{Std} - \text{FEL}) \cdot \text{Volume} \cdot \text{AvgPR} \cdot \text{UL} \cdot 10^{-3}$$

Eq. 1039.705–1

Where:

Std = the emission standard, in grams per kilowatt-hour, that applies under subpart

B of this part for engines not participating in the ABT program of this subpart (the “otherwise applicable standard”).

FEL = the family emission limit for the engine family, in grams per kilowatt-hour.

Volume = the number of engines eligible to participate in the averaging, banking, and trading program within the given engine family during the model year, as described in paragraph (c) of this section.

AvgPR = the average value of maximum engine power values for the engine configurations within an engine family, calculated on a sales-weighted basis, in kilowatts.

UL = the useful life for the given engine family, in hours.

\* \* \* \* \*

**PART 1054—CONTROL OF EMISSIONS FROM NEW, SMALL NONROAD SPARK-IGNITION ENGINES AND EQUIPMENT**

■ 117. The authority citation for part 1054 continues to read as follows:

Authority: 42 U.S.C. 7401–7671q.

■ 118. Amend § 1054.501 by revising paragraph (b)(7) to read as follows:

**§ 1054.501 How do I run a valid emission test?**

\* \* \* \* \*

(b) \* \* \*

(7) Determine your test fuel’s carbon mass fraction,  $w_c$ , using a calculation based on fuel properties as described in 40 CFR 1065.655(d); however, you must measure fuel properties for  $\alpha$  and  $\beta$  rather than using the default values specified in 40 CFR 1065.655(e).

\* \* \* \* \*

**PART 1065—ENGINE-TESTING PROCEDURES**

■ 119. The authority citation for part 1065 continues to read as follows:

Authority: 42 U.S.C. 7401–7671q.

■ 120. Amend § 1065.12 by revising paragraph (d)(1) to read as follows:

**§ 1065.12 Approval of alternate procedures.**

\* \* \* \* \*

(d) \* \* \*

(1) *Theoretical basis.* Give a brief technical description explaining why you believe the proposed alternate procedure should result in emission measurements equivalent to those using the specified procedure. You may include equations, figures, and references. You should consider the full range of parameters that may affect equivalence. For example, for a request to use a different NO<sub>x</sub> measurement procedure, you should theoretically

relate the alternate detection principle to the specified detection principle over the expected concentration ranges for NO, NO<sub>2</sub>, and interference species. For a request to use a different PM measurement procedure, you should explain the principles by which the alternate procedure quantifies particulate mass similarly to the specified procedures.

\* \* \* \* \*

■ 121. Amend § 1065.170 by revising paragraph (c)(1)(i) to read as follows:

**§ 1065.170 Batch sampling for gaseous and PM constituents.**

\* \* \* \* \*

(c) \* \* \*

(1) \* \* \*

(i) If you expect that a filter’s total surface concentration of PM will exceed 400 µg, assuming a 38 mm diameter filter stain area, for a given test interval, you may use filter media with a minimum initial collection efficiency of 98%; otherwise you must use a filter media with a minimum initial collection efficiency of 99.7%. Collection efficiency must be measured as described in ASTM D2986 (incorporated by reference, see § 1065.1010), though you may rely on the sample-media manufacturer’s measurements reflected in their product ratings to show that you meet the requirement in this paragraph (c)(1)(i).

\* \* \* \* \*

■ 122. Amend § 1065.190 by revising paragraph (b) to read as follows:

**§ 1065.190 PM-stabilization and weighing environments for gravimetric analysis.**

\* \* \* \* \*

(b) We recommend that you keep both the stabilization and the weighing environments free of ambient contaminants, such as dust, aerosols, or semi-volatile material that could contaminate PM samples. We recommend that these environments conform with an “as-built” Class Six clean room specification according to ISO 14644–1 (incorporated by reference, see § 1065.1010); however, we also recommend that you deviate from ISO 14644–1 as necessary to minimize air motion that might affect weighing. We recommend maximum air-supply and air-return velocities of 0.05 m/s in the weighing environment.

\* \* \* \* \*

■ 123. Amend § 1065.210 by revising paragraph (a) to read as follows:

**§ 1065.210 Work input and output sensors.**

(a) *Application.* Use instruments as specified in this section to measure work inputs and outputs during engine

operation. We recommend that you use sensors, transducers, and meters that meet the specifications in § 1065.205. Note that your overall systems for measuring work inputs and outputs must meet the linearity verifications in § 1065.307. In all cases, ensure that you are able to accurately demonstrate compliance with the applicable standards in this chapter. The following additional provisions apply related to work inputs and outputs:

(1) We recommend that you measure work inputs and outputs where they cross the system boundary as shown in figure 1 to paragraph (a)(5) of this section. The system boundary is different for air-cooled engines than for liquid-cooled engines.

(2) For measurements involving work conversion relative to a system boundary use good engineering

judgment to estimate any work-conversion losses in a way that avoids overestimation of total work. For example, if it is impractical to instrument the shaft of an exhaust turbine generating electrical work, you may decide to measure its converted electrical work. As another example, you may decide to measure the tractive (i.e., electrical output) power of a locomotive, rather than the brake power of the locomotive engine. For measuring tractive power based on electrical output, divide the electrical work by accurate values of electrical generator efficiency ( $\eta < 1$ ), or assume an efficiency of 1 ( $\eta = 1$ ), which would overestimate brake-specific emissions. For the example of using locomotive tractive power with a generator efficiency of 1 ( $\eta = 1$ ), this means using the tractive

power as the brake power in emission calculations.

(3) If your engine includes an externally powered electrical heater to heat engine exhaust, assume an electrical generator efficiency of 0.67 ( $\eta = 0.67$ ) to account for the work needed to run the heater.

(4) Do not underestimate any work conversion efficiencies for any components outside the system boundary that do not return work into the system boundary. And do not overestimate any work conversion efficiencies for components outside the system boundary that return work into the system boundary.

(5) Figure 1 to this paragraph (a)(5) follows:

**Figure 1 to paragraph (A)(5) of § 1065.210: Work Inputs, Outputs, and System Boundaries**

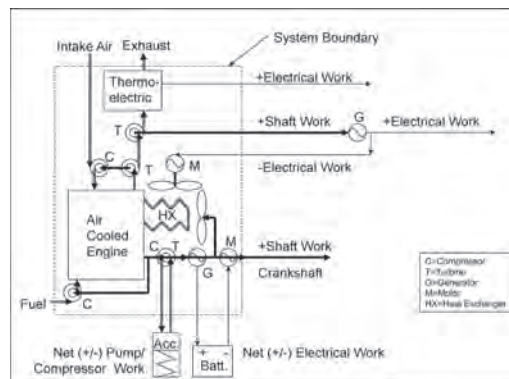
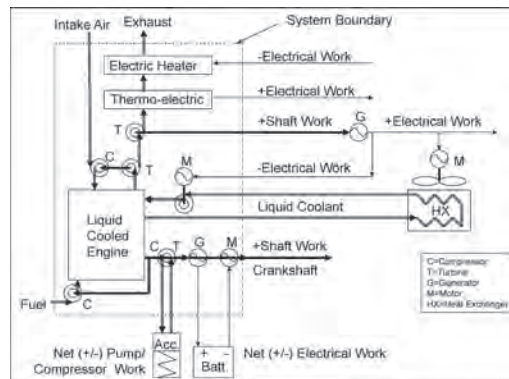

\* \* \* \* \*

■ 124. Revise the undesignated center heading preceding § 1065.250 to read as follows:

Hydrocarbon, H<sub>2</sub>, and H<sub>2</sub>O Measurements

■ 125. Add §§ 1065.255 and 1065.257 under newly revised undesignated center heading “Hydrocarbon, H<sub>2</sub>, and H<sub>2</sub>O Measurements” to read as follows:

**§ 1065.255 H<sub>2</sub> measurement devices.**

(a) *Component requirements.* We recommend that you use an analyzer that meets the specifications in § 1065.205. Note that your system must meet the linearity verification in § 1065.307.

(b) *Instrument types.* You may use any of the following analyzers to measure H<sub>2</sub>:

(1) Magnetic sector mass spectrometer.

(2) Raman spectrometer.

(c) *Interference verification.* Certain compounds can positively interfere with magnetic sector mass spectroscopy and raman spectroscopy by causing a response similar to H<sub>2</sub>. Use good engineering judgment to determine interference species when performing interference verification. In the case of raman spectroscopy, determine interference species that are appropriate for each H<sub>2</sub> infrared absorption band, or

you may identify the interference species based on the instrument manufacturer's recommendations.

**§ 1065.257 H<sub>2</sub>O measurement devices.**

(a) *Component requirements.* We recommend that you use an analyzer that meets the specifications in § 1065.205. Note that your system must meet the linearity verification in § 1065.307 with a humidity generator meeting the requirements of § 1065.750(a)(6).

(b) *Measurement principles.* Use appropriate analytical procedures for interpretation of infrared spectra. For example, EPA Test Method 320 (see § 1065.266(b)) and ASTM D6348 (incorporated by reference, see § 1065.1010) are considered valid methods for spectral interpretation. You must use heated analyzers that maintain all surfaces that are exposed to emissions at a temperature of (110 to 202) °C.

(c) *Instrument types.* You may use any of the following analyzers to measure H<sub>2</sub>O:

(1) Fourier transform infrared (FTIR) analyzer.

(2) Laser infrared analyzer. Examples of laser infrared analyzers are pulsed-mode high-resolution narrow band mid-infrared analyzers and modulated continuous wave high-resolution narrow band near or mid-infrared analyzers.

(d) *Interference verification.* Certain compounds can interfere with FTIR and laser infrared analyzers by causing a response similar to water. Perform interference verification for the following interference species:

(1) Perform CO<sub>2</sub> interference verification for FTIR analyzers using the procedures of § 1065.357. Use good engineering judgment to determine other interference species for FTIR analyzers when performing interference verification. Consider at least CO, NO, C<sub>2</sub>H<sub>4</sub>, and C<sub>7</sub>H<sub>8</sub>. Perform interference verifications using the procedures of § 1065.357, replacing occurrences of CO<sub>2</sub> with each targeted interference species. Determine interference species under this paragraph (d)(1) that are appropriate for each H<sub>2</sub>O infrared absorption band, or you may identify the interference species based on the instrument manufacturer's recommendations.

(2) Perform interference verification for laser infrared analyzers using the procedures of § 1065.375. Use good engineering judgment to determine interference species for laser infrared analyzers. Note that interference species are dependent on the H<sub>2</sub>O infrared absorption band chosen by the

instrument manufacturer. For each analyzer determine the H<sub>2</sub>O infrared absorption band. Determine interference species under this paragraph (d)(2) that are appropriate for each H<sub>2</sub>O infrared absorption band, or you may identify the interference species based on the instrument manufacturer's recommendations.

■ 126. Revise § 1065.266 to read as follows:

**§ 1065.266 Fourier transform infrared analyzer.**

(a) *Application.* For engines that run only on natural gas, you may use a Fourier transform infrared (FTIR) analyzer to measure nonmethane hydrocarbon (NMHC) and nonmethane nonethane hydrocarbon (NMNEHC) for continuous sampling. You may use an FTIR analyzer with any gaseous-fueled engine, including dual-fuel and flexible-fuel engines, to measure CH<sub>4</sub> and C<sub>2</sub>H<sub>6</sub>, for either batch or continuous sampling (for subtraction from THC).

(b) *Component requirements.* We recommend that you use an FTIR analyzer that meets the specifications in § 1065.205.

(c) *Measurement principles.* Note that your FTIR-based system must meet the linearity verification in § 1065.307. Use appropriate analytical procedures for interpretation of infrared spectra. For example, EPA Test Method 320 in 40 CFR part 63, appendix A, and ASTM D6348 (incorporated by reference, see § 1065.1010) are considered valid methods for spectral interpretation. You must use heated FTIR analyzers that maintain all surfaces that are exposed to emissions at a temperature of (110 to 202) °C.

(d) *Hydrocarbon species for NMHC and NMNEHC additive determination.* To determine NMNEHC, measure ethene, ethyne, propane, propene, butane, formaldehyde, acetaldehyde, formic acid, and methanol. To determine NMHC, measure ethane in addition to those same hydrocarbon species. Determine NMHC and NMNEHC as described in § 1065.660(b)(4) and (c)(3).

(e) *NMHC and NMNEHC determination from subtraction of CH<sub>4</sub> and C<sub>2</sub>H<sub>6</sub> from THC.* Determine NMHC from subtraction of CH<sub>4</sub> from THC as described in § 1065.660(b)(3) and NMNEHC from subtraction of CH<sub>4</sub> and C<sub>2</sub>H<sub>6</sub> as described § 1065.660(c)(2). Determine CH<sub>4</sub> as described in § 1065.660(d)(2) and C<sub>2</sub>H<sub>6</sub> as described § 1065.660(e).

(f) *Interference verification.* Perform interference verification for FTIR analyzers using the procedures of § 1065.366. Certain species can interfere

with FTIR analyzers by causing a response similar to the hydrocarbon species of interest. When running the interference verification for these analyzers, use interference species as follows:

(1) The interference species for CH<sub>4</sub> are CO<sub>2</sub>, H<sub>2</sub>O, and C<sub>2</sub>H<sub>6</sub>.

(2) The interference species for C<sub>2</sub>H<sub>6</sub> are CO<sub>2</sub>, H<sub>2</sub>O, and CH<sub>4</sub>.

(3) The interference species for other measured hydrocarbon species are CO<sub>2</sub>, H<sub>2</sub>O, CH<sub>4</sub>, and C<sub>2</sub>H<sub>6</sub>.

■ 127. Amend § 1065.267 by revising paragraph (b) to read as follows:

**§ 1065.267 Gas chromatograph with a flame ionization detector.**

\* \* \* \* \*

(b) *Component requirements.* We recommend that you use a GC-FID that meets the specifications in § 1065.205 and that the measurement be done according to SAE J1151 (incorporated by reference, see § 1065.1010). The GC-FID must meet the linearity verification in § 1065.307.

■ 128. Revise the undesignated center heading preceding § 1065.270 to read as follows:

NO<sub>x</sub>, N<sub>2</sub>O, and NH<sub>3</sub> Measurements

■ 129. Amend § 1065.270 by revising the section heading to read as follows:

**§ 1065.270 Chemiluminescent NO<sub>x</sub> analyzer.**

\* \* \* \* \*

■ 130. Amend § 1065.272 by revising the section heading to read as follows:

**§ 1065.272 Nondispersive ultraviolet NO<sub>x</sub> analyzer.**

\* \* \* \* \*

■ 131. Amend § 1065.275 by revising paragraphs (b)(2) and (c) to read as follows:

**§ 1065.275 N<sub>2</sub>O measurement devices.**

\* \* \* \* \*

(b) \* \* \*

(2) Fourier transform infrared (FTIR) analyzer. Use appropriate analytical procedures for interpretation of infrared spectra. For example, EPA Test Method 320 in 40 CFR part 63, appendix A, and ASTM D6348 (incorporated by reference, see § 1065.1010) are considered valid methods for spectral interpretation.

\* \* \* \* \*

(c) *Interference verification.* Certain compounds can positively interfere with NDIR, FTIR, laser infrared analyzers, and photoacoustic analyzers by causing a response similar to N<sub>2</sub>O. Perform interference verification for NDIR, FTIR, laser infrared analyzers, and photoacoustic analyzers using the



procedures of § 1065.375. Interference verification is not required for GC-ECD. Perform interference verification for the following interference species:

(1) The interference species for NDIR analyzers are CO, CO<sub>2</sub>, H<sub>2</sub>O, CH<sub>4</sub>, and SO<sub>2</sub>. Note that interference species, with the exception of H<sub>2</sub>O, are dependent on the N<sub>2</sub>O infrared absorption band chosen by the instrument manufacturer. For each analyzer determine the N<sub>2</sub>O infrared absorption band. For each N<sub>2</sub>O infrared absorption band, use good engineering judgment to determine which interference species to evaluate for interference verification.

(2) Use good engineering judgment to determine interference species for FTIR and laser infrared analyzers. Note that interference species, with the exception of H<sub>2</sub>O, are dependent on the N<sub>2</sub>O infrared absorption band chosen by the instrument manufacturer. For each analyzer determine the N<sub>2</sub>O infrared absorption band. Determine interference species under this paragraph (c)(2) that are appropriate for each N<sub>2</sub>O infrared absorption band, or you may identify the interference species based on the instrument manufacturer's recommendations.

(3) The interference species for photoacoustic analyzers are CO, CO<sub>2</sub>, and H<sub>2</sub>O.

■ 132. Add § 1065.277 under newly revised undesignated center heading "NO<sub>x</sub>, N<sub>2</sub>O, AND NH<sub>3</sub> MEASUREMENTS" to read as follows:

**§ 1065.277 NH<sub>3</sub> measurement devices.**

(a) *General component requirements.* We recommend that you use an analyzer that meets the specifications in § 1065.205. Note that your system must meet the linearity verification in § 1065.307.

(b) *Instrument types.* You may use any of the following analyzers to measure NH<sub>3</sub>:

(1) Nondispersive ultraviolet (NDUV) analyzer.

(2) Fourier transform infrared (FTIR) analyzer. Use appropriate analytical procedures for interpretation of infrared spectra. For example, EPA Test Method 320 (see § 1065.266(c)) and ASTM D6348 (incorporated by reference, see § 1065.1010) are considered valid methods for spectral interpretation.

(3) Laser infrared analyzer. Examples of laser infrared analyzers are pulsed-mode high-resolution narrow-band mid-infrared analyzers, modulated continuous wave high-resolution narrow band near and mid-infrared analyzers, and modulated continuous-wave high-resolution near-infrared analyzers. A quantum cascade laser, for example, can emit coherent light in the

mid-infrared region where NH<sub>3</sub> and other nitrogen compounds can effectively absorb the laser's energy.

(c) *Sampling system.* Minimize NH<sub>3</sub> losses and sampling artifacts related to NH<sub>3</sub> adsorbing to surfaces by using sampling system components (sample lines, prefilters and valves) made of stainless steel or PTFE heated to (110 to 202) °C. If surface temperatures exceed ≥130 °C, take steps to prevent any DEF in the sample gas from thermally decomposing and hydrolyzing to form NH<sub>3</sub>. Use a sample line that is as short as practical.

(d) *Interference verification.* Certain species can positively interfere with NDUV, FTIR, and laser infrared analyzers by causing a response similar to NH<sub>3</sub>. Perform interference verification as follows:

(1) Perform SO<sub>2</sub> and H<sub>2</sub>O interference verification for NDUV analyzers using the procedures of § 1065.372, replacing occurrences of NO<sub>x</sub> with NH<sub>3</sub>. NDUV analyzers must have combined interference that is within (0.0 ±2.0) μmol/mol.

(2) Perform interference verification for FTIR and laser infrared analyzers using the procedures of § 1065.377. Use good engineering judgment to determine interference species. Note that interference species, with the exception of H<sub>2</sub>O, are dependent on the NH<sub>3</sub> infrared absorption band chosen by the instrument manufacturer. Determine interference species under this paragraph (d)(2) that are appropriate for each NH<sub>3</sub> infrared absorption band, or you may identify the interference species based on the instrument manufacturer's recommendations.

■ 133. Revise the undesignated center heading preceding § 1065.280 to read as follows:

**O<sub>2</sub> And Air-to-Fuel Ratio Measurements**

■ 134. Amend § 1065.280 by revising paragraph (b) to read as follows:

**§ 1065.280 Paramagnetic and magnetopneumatic O<sub>2</sub> detection analyzers.**

(b) *Component requirements.* We recommend that you use a PMD or MPD analyzer that meets the specifications in § 1065.205. Note that it must meet the linearity verification in § 1065.307.

■ 135. Remove the undesignated center heading "Air-to-Fuel Ratio Measurements" preceding § 1065.284.

■ 136. Amend § 1065.284 by revising paragraph (b) to read as follows:

**§ 1065.284 Zirconium dioxide (ZrO<sub>2</sub>) air-fuel ratio and O<sub>2</sub> analyzer.**

(b) *Component requirements.* We recommend that you use a ZrO<sub>2</sub> analyzer that meets the specifications in § 1065.205. Note that your ZrO<sub>2</sub>-based system must meet the linearity verification in § 1065.307.

■ 137. Amend § 1065.315 by revising paragraphs (a)(2) and (3) to read as follows:

**§ 1065.315 Pressure, temperature, and dewpoint calibration.**

(a) \* \* \*

(2) *Temperature.* We recommend digital dry-block or stirred-liquid temperature calibrators, with data logging capabilities to minimize transcription errors. We recommend using calibration reference quantities for absolute temperature that are NIST-traceable within ±0.5% uncertainty. You may perform linearity verification for temperature measurement systems with thermocouples, RTDs, and thermistors by removing the sensor from the system and using a simulator in its place. Use a NIST-traceable simulator that is independently calibrated and, as appropriate, cold-junction compensated. The simulator uncertainty scaled to absolute temperature must be less than 0.5% of T<sub>max</sub>. If you use this option, you must use sensors that the supplier states are accurate to better than 0.5% of T<sub>max</sub> compared with their standard calibration curve.

(3) *Dewpoint.* We recommend a minimum of three different temperature-equilibrated and temperature-monitored calibration salt solutions in containers that seal completely around the dewpoint sensor. We recommend using calibration reference quantities for absolute dewpoint temperature that are NIST-traceable within ±0.5% uncertainty.

\* \* \* \* \*

■ 138. Amend § 1065.341 by revising paragraph (c) introductory text to read as follows:

**§ 1065.341 CVS and PFD flow verification (propane check).**

(c) If you performed the vacuum-side leak verification of the HC sampling system as described in paragraph (b)(8) of this section, you may use the HC contamination procedure in § 1065.520(g) to verify HC contamination. Otherwise, zero, span, and verify contamination of the HC sampling system, as follows:

\* \* \* \* \*

■ 139. Amend § 1065.350 by:

■ a. Revising paragraph (b);

■ b. Removing the undesignated paragraph following paragraph (b);

- c. Revising paragraph (d)(7); and
  - d. Adding paragraph (d)(8).
- The revisions and addition read as follows:

**§ 1065.350 H<sub>2</sub>O interference verification for CO<sub>2</sub> NDIR analyzers.**

\* \* \* \* \*

(b) *Measurement principles.* H<sub>2</sub>O can interfere with an NDIR analyzer's response to CO<sub>2</sub>. If the NDIR analyzer uses compensation algorithms that utilize measurements of other gases to meet this interference verification, a correct result depends on simultaneously conducting these other measurements to test the compensation algorithms during the analyzer interference verification.

\* \* \* \* \*

(d) \* \* \*

(7) Operate the analyzer to get a reading for CO<sub>2</sub> concentration and record results for 30 seconds. Calculate the arithmetic mean of this data.

(8) The analyzer meets the interference verification if the result of paragraph (d)(7) of this section meets the tolerance in paragraph (c) of this section.

\* \* \* \* \*

- 140. Amend § 1065.355 by revising paragraphs (b) and (d)(7) to read as follows:

**§ 1065.355 H<sub>2</sub>O and CO<sub>2</sub> interference verification for CO NDIR analyzers.**

\* \* \* \* \*

(b) *Measurement principles.* H<sub>2</sub>O and CO<sub>2</sub> can positively interfere with an NDIR analyzer by causing a response similar to CO. If the NDIR analyzer uses compensation algorithms that utilize measurements of other gases to meet this interference verification, a correct result depends on simultaneously conducting these other measurements to test the compensation algorithms during the analyzer interference verification.

\* \* \* \* \*

(d) \* \* \*

(7) Operate the analyzer to get a reading for CO concentration and record results for 30 seconds. Calculate the arithmetic mean of this data.

\* \* \* \* \*

- 141. Add an undesignated center heading and § 1065.357 after § 1065.355 to read as follows:

H<sub>2</sub>O Measurements

**§ 1065.357 CO<sub>2</sub> interference verification for H<sub>2</sub>O FTIR analyzers.**

(a) *Scope and frequency.* If you measure H<sub>2</sub>O using an FTIR analyzer, verify the amount of CO<sub>2</sub> interference after initial analyzer installation and after major maintenance.

(b) *Measurement principles.* CO<sub>2</sub> can interfere with an FTIR analyzer's response to H<sub>2</sub>O. If the FTIR analyzer uses compensation algorithms that utilize measurements of other gases to meet this interference verification, a correct result depends on simultaneously conducting these other measurements to test the compensation algorithms during the analyzer interference verification.

(c) *System requirements.* An H<sub>2</sub>O FTIR analyzer must have a CO<sub>2</sub> interference that is within (0.0 ± 0.4) mmol/mol, though we strongly recommend a lower interference that is within (0.0 ± 0.2) mmol/mol.

(d) *Procedure.* Perform the interference verification as follows:

(1) Start, operate, zero, and span the H<sub>2</sub>O FTIR analyzer as you would before an emission test.

(2) Use a CO<sub>2</sub> span gas that meets the specifications of § 1065.750 and a concentration that is approximately the maximum CO<sub>2</sub> concentration expected during emission testing.

(3) Introduce the CO<sub>2</sub> test gas into the sample system.

(4) Allow time for the analyzer response to stabilize. Stabilization time may include time to purge the transfer line and to account for analyzer response.

(5) Operate the analyzer to get a reading for H<sub>2</sub>O concentration and record results for 30 seconds. Calculate the arithmetic mean of these data.

(6) The analyzer meets the interference verification if the result of paragraph (d)(5) of this section meets the tolerance in paragraph (c) of this section.

(e) *Exceptions.* The following exceptions apply:

(1) You may omit this verification for CO<sub>2</sub> for engines operating on fuels other than carbon-containing fuels.

(2) You may omit this verification if you can show by engineering analysis that for your H<sub>2</sub>O sampling system and your emission-calculation procedures, the CO<sub>2</sub> interference for your H<sub>2</sub>O FTIR analyzer always affects your brake-specific emission results within ±0.5% of each of the applicable standards in this chapter. This specification also applies for vehicle testing, except that it relates to emission results in g/mile or g/kilometer.

(3) You may use an H<sub>2</sub>O FTIR analyzer that you determine does not meet this verification, as long as you try to correct the problem and the measurement deficiency does not adversely affect your ability to show that engines comply with all applicable emission standards.

- 142. Amend § 1065.360 by revising paragraphs (a)(4), (b), (c), (d) introductory text, and (d)(12) to read as follows:

**§ 1065.360 FID optimization and verification.**

(a) \* \* \*

(4) You may determine the methane (CH<sub>4</sub>) and ethane (C<sub>2</sub>H<sub>6</sub>) response factors as a function of the molar water concentration in the raw or diluted exhaust. If you choose the option in this paragraph (a)(4), generate and verify the humidity level (or fraction) as described in § 1065.365(g).

(b) *Calibration.* Use good engineering judgment to develop a calibration procedure, such as one based on the FID-analyzer manufacturer's instructions and recommended frequency for calibrating the FID.

Alternately, you may remove system components for off-site calibration. For a FID that measures THC, calibrate using C<sub>3</sub>H<sub>8</sub> calibration gases that meet the specifications of § 1065.750. For a FID that measures CH<sub>4</sub>, calibrate using CH<sub>4</sub> calibration gases that meet the specifications of § 1065.750. We recommend FID analyzer zero and span gases that contain approximately the flow-weighted mean concentration of O<sub>2</sub> expected during testing. If you use a FID to measure CH<sub>4</sub> downstream of a nonmethane cutter (NMC), you may calibrate that FID using CH<sub>4</sub> calibration gases with the NMC. Regardless of the calibration gas composition, calibrate on a carbon number basis of one (C<sub>1</sub>). For example, if you use a C<sub>3</sub>H<sub>8</sub> span gas of concentration 200 µmol/mol, span the FID to respond with a value of 600 µmol/mol. As another example, if you use a CH<sub>4</sub> span gas with a concentration of 200 µmol/mol, span the FID to respond with a value of 200 µmol/mol.

(c) *THC FID response optimization.* This procedure is only for FID analyzers that measure THC. Use good engineering judgment for initial instrument start-up and basic operating adjustment using FID fuel and zero air. Heated FIDs must be within their required operating temperature ranges. Optimize FID response at the most common analyzer range expected during emission testing. Optimization involves adjusting flows and pressures of FID fuel, burner air, and sample to minimize response variations to various hydrocarbon species in the exhaust. Use good engineering judgment to trade off peak FID response to propane calibration gases to achieve minimal response variations to different hydrocarbon species. For an example of trading off response to propane for relative responses to other hydrocarbon

species, see SAE 770141 (incorporated by reference, see § 1065.1010). Determine the optimum flow rates and/or pressures for FID fuel, burner air, and sample and record them for future reference.

(d) *THC FID CH<sub>4</sub> response factor determination.* This procedure is only for FID analyzers that measure THC. Since FID analyzers generally have a different response to CH<sub>4</sub> versus C<sub>3</sub>H<sub>8</sub>, determine the THC–FID analyzer’s CH<sub>4</sub> response factor,  $RF_{CH_4[THC-FID]}$ , after FID optimization. Use the most recent  $RF_{CH_4[THC-FID]}$  measured according to this section in the calculations for HC determination described in § 1065.660 to compensate for CH<sub>4</sub> response. Determine  $RF_{CH_4[THC-FID]}$  as follows, noting that you do not determine  $RF_{CH_4[THC-FID]}$  for FIDs that are calibrated and spanned using CH<sub>4</sub> with an NMC:

\* \* \* \* \*

(12) You may determine the response factor as a function of molar water concentration using the following procedures and use this response factor to account for the CH<sub>4</sub> response for NMHC determination described in § 1065.660(b)(2)(iii):

(i) Humidify the CH<sub>4</sub> span gas as described in § 1065.365(g) and repeat the steps in paragraphs (d)(7) through (9) of this section until measurements are complete for each setpoint in the selected range.

(ii) Divide each mean measured CH<sub>4</sub> concentration by the recorded span concentration of the CH<sub>4</sub> calibration gas, adjusted for water content, to determine the FID analyzer’s CH<sub>4</sub> response factor,  $RF_{CH_4[THC-FID]}$ .

(iii) Use the CH<sub>4</sub> response factors at the different setpoints to create a functional relationship between response factor and molar water concentration, downstream of the last sample dryer if any sample dryers are present.

(iv) Use this functional relationship to determine the response factor during an emission test.

\* \* \* \* \*

■ 143. Revise § 1065.365 to read as follows:

**§ 1065.365 Nonmethane cutter penetration fractions and NMC FID response factors.**

(a) *Scope and frequency.* If you use a FID analyzer and an NMC to measure methane (CH<sub>4</sub>), verify that the catalytic activity of the NMC has not deteriorated as described in this section. Determine the NMC’s penetration fractions (PF) of CH<sub>4</sub> and ethane (C<sub>2</sub>H<sub>6</sub>) and, if applicable, the FID analyzer response factors using the appropriate procedures

of paragraph (d), (e), or (f) of this section. As detailed in this section, these penetration fractions may be determined as a combination of NMC penetration fractions and FID analyzer response factors, depending on your particular NMC and FID analyzer configuration. Perform this verification after installing the NMC and repeat this verification within 185 days of testing. Note that because NMCs can deteriorate rapidly and without warning if they are operated outside of certain ranges of gas concentrations and outside of certain temperature ranges, good engineering judgment may dictate that you determine an NMC’s penetration fractions more frequently. Use the most recently determined penetration fraction from this section to calculate HC emissions according to § 1065.660 as applicable.

(b) *Measurement principles.* An NMC is a heated catalyst that removes nonmethane hydrocarbons from an exhaust sample stream before the FID analyzer measures the remaining hydrocarbon concentration. An ideal NMC would have a CH<sub>4</sub> penetration fraction,  $PF_{CH_4}$ , of 1.000, and the penetration fraction for all other nonmethane hydrocarbons would be 0.000, as represented by  $PF_{C_2H_6}$ . The emission calculations in § 1065.660 use the measured values from this verification to account for less than ideal NMC performance.

(c) *System requirements.* We do not require that you limit NMC penetration fractions to a certain range. However, we recommend that you optimize an NMC by adjusting its temperature to achieve a  $PF_{C_2H_6} < 0.02$ , as determined by paragraph (d), (e), or (f) of this section, as applicable, using dry gases. If adjusting NMC temperature does not result in achieving the recommended  $PF_{C_2H_6}$  level, we recommend that you replace the catalyst material. Note that, if we use an NMC for testing, we will optimize it to achieve a  $PF_{C_2H_6} < 0.02$ .

(d) *Procedure for a FID calibrated with the NMC.* The following procedure describes the recommended method for verifying NMC performance and the required method for any gaseous-fueled engine, including dual-fuel and flexible-fuel engines.

(1) Select CH<sub>4</sub> and C<sub>2</sub>H<sub>6</sub> analytical gas mixtures and ensure that both mixtures meet the specifications of § 1065.750. Select a CH<sub>4</sub> concentration that you would use for spanning the FID during emission testing and select a C<sub>2</sub>H<sub>6</sub> concentration that is typical of the peak NMHC concentration expected at the hydrocarbon standard or equal to the THC analyzer’s span value. For CH<sub>4</sub> analyzers with multiple ranges, perform

this procedure on the highest range used for emission testing.

(2) Start, operate, and optimize the NMC according to the manufacturer’s instructions, including any temperature optimization.

(3) Confirm that the FID analyzer meets all the specifications of § 1065.360.

(4) Start and operate the FID analyzer according to the manufacturer’s instructions.

(5) Zero and span the FID with the NMC as you would during emission testing. Span the FID through the NMC by using CH<sub>4</sub> span gas.

(6) Introduce the C<sub>2</sub>H<sub>6</sub> analytical gas mixture upstream of the NMC. Use good engineering judgment to address the effect of hydrocarbon contamination if your point of introduction is vastly different from the point of zero/span gas introduction.

(7) Allow time for the analyzer response to stabilize. Stabilization time may include time to purge the NMC and to account for the analyzer’s response.

(8) While the analyzer measures a stable concentration, record 30 seconds of sampled data. Calculate the arithmetic mean of the analytical gas mixture.

(9) Calculate a reference concentration of C<sub>2</sub>H<sub>6</sub>, by converting C<sub>2</sub>H<sub>6</sub> to a C<sub>1</sub> basis and adjusted for water content, if necessary. Calculate the combined C<sub>2</sub>H<sub>6</sub> response factor and penetration fraction,  $RFPF_{C_2H_6[NMC-FID]}$ , by dividing the mean C<sub>2</sub>H<sub>6</sub> concentration from paragraph (d)(8) of this section by the reference concentration of C<sub>2</sub>H<sub>6</sub>. For any gaseous-fueled engine, including dual-fuel and flexible-fuel engines, you must determine  $RFPF_{C_2H_6[NMC-FID]}$  as a function of the molar water concentration in the raw or diluted exhaust using paragraph (g) of this section. Use  $RFPF_{C_2H_6[NMC-FID]}$  at the different setpoints to create a functional relationship between  $RFPF_{C_2H_6[NMC-FID]}$  and molar water concentration, downstream of the last sample dryer if any sample dryers are present. Use this functional relationship to determine the combined response factor and penetration fraction during the emission test. For any other engine you may use the same procedure or you may determine  $RFPF_{C_2H_6[NMC-FID]}$  at zero molar water concentration.

(10) For any gaseous-fueled engine, including dual-fuel and flexible-fuel engines, repeat the steps in paragraphs (d)(6) through (9) of this section, but with the CH<sub>4</sub> analytical gas mixture instead of C<sub>2</sub>H<sub>6</sub> and determine  $RFPF_{CH_4[NMC-FID]}$  as a function of the molar water concentration in the raw or diluted exhaust using paragraph (g) of

this section. Note that  $RFPF_{CH_4[NMC-FID]}$  is set equal to 1.0 only for zero molar water concentration. For any other engine you may use the same procedure, or you may set  $RFPF_{CH_4[NMC-FID]}$  equal to 1.0.

(11) Use  $RFPF_{C_2H_6[NMC-FID]}$  and  $RFPF_{CH_4[NMC-FID]}$  in emission calculations according to § 1065.660(b)(2)(i) and (d)(1)(i).

(e) *Procedure for a FID calibrated with propane, bypassing the NMC.* If you use a single FID for THC and  $CH_4$  determination with an NMC that is calibrated with propane,  $C_3H_8$ , by bypassing the NMC, determine its penetration fractions,  $PF_{C_2H_6[NMC-FID]}$  and  $PF_{CH_4[NMC-FID]}$ , as follows:

(1) Select  $CH_4$  and  $C_2H_6$  analytical gas mixtures and ensure that both mixtures meet the specifications of § 1065.750. Select a  $CH_4$  concentration that you would use for spanning the FID during emission testing and select a  $C_2H_6$  concentration that is typical of the peak NMHC concentration expected at the hydrocarbon standard and the  $C_2H_6$  concentration typical of the peak total hydrocarbon (THC) concentration expected at the hydrocarbon standard or equal to the THC analyzer's span value. For  $CH_4$  analyzers with multiple ranges, perform this procedure on the highest range used for emission testing.

(2) Start and operate the NMC according to the manufacturer's instructions, including any temperature optimization.

(3) Confirm that the FID analyzer meets all the specifications of § 1065.360.

(4) Start and operate the FID analyzer according to the manufacturer's instructions.

(5) Zero and span the FID as you would during emission testing. Span the FID by bypassing the NMC and by using  $C_3H_8$  span gas. Note that you must span the FID on a  $C_1$  basis. For example, if your span gas has a propane reference value of 100  $\mu\text{mol/mol}$ , the correct FID response to that span gas is 300  $\mu\text{mol/mol}$  because there are three carbon atoms per  $C_3H_8$  molecule.

(6) Introduce the  $C_2H_6$  analytical gas mixture upstream of the NMC. Use good engineering judgment to address the effect of hydrocarbon contamination if your point of introduction is vastly different from the point of zero/span gas introduction.

(7) Allow time for the analyzer response to stabilize. Stabilization time may include time to purge the NMC and to account for the analyzer's response.

(8) While the analyzer measures a stable concentration, record 30 seconds of sampled data. Calculate the

arithmetic mean of the analytical gas mixture.

(9) Reroute the flow path to bypass the NMC, introduce the  $C_2H_6$  analytical gas mixture, and repeat the steps in paragraphs (e)(7) and (8) of this section.

(10) Divide the mean  $C_2H_6$  concentration measured through the NMC by the mean  $C_2H_6$  concentration measured after bypassing the NMC. The result is the  $C_2H_6$  penetration fraction,  $PF_{C_2H_6[NMC-FID]}$ . Use this penetration fraction according to § 1065.660(b)(2)(ii) and (d)(1)(ii).

(11) Repeat the steps in paragraphs (e)(6) through (10) of this section, but with the  $CH_4$  analytical gas mixture instead of  $C_2H_6$ . The result will be the  $CH_4$  penetration fraction,  $PF_{CH_4[NMC-FID]}$ . Use this penetration fraction according to § 1065.660(b)(2)(ii) or § 1065.665, as applicable.

(f) *Procedure for a FID calibrated with  $CH_4$ , bypassing the NMC.* If you use a FID with an NMC that is calibrated with  $CH_4$  by bypassing the NMC, determine its combined  $C_2H_6$  response factor and penetration fraction,  $RFPF_{C_2H_6[NMC-FID]}$ , as well as its  $CH_4$  penetration fraction,  $PF_{CH_4[NMC-FID]}$ , as follows:

(1) Select  $CH_4$  and  $C_2H_6$  analytical gas mixtures and ensure that both mixtures meet the specifications of § 1065.750. Select a  $CH_4$  concentration that you would use for spanning the FID during emission testing and select a  $C_2H_6$  concentration that is typical of the peak NMHC concentration expected at the hydrocarbon standard or equal to the THC analyzer's span value. For  $CH_4$  analyzers with multiple ranges, perform this procedure on the highest range used for emission testing.

(2) Start and operate the NMC according to the manufacturer's instructions, including any temperature optimization.

(3) Confirm that the FID analyzer meets all the specifications of § 1065.360.

(4) Start and operate the FID analyzer according to the manufacturer's instructions.

(5) Zero and span the FID as you would during emission testing. Span the FID by bypassing the NMC and by using  $CH_4$  span gas.

(6) Introduce the  $C_2H_6$  analytical gas mixture upstream of the NMC. Use good engineering judgment to address the effect of hydrocarbon contamination if your point of introduction is vastly different from the point of zero/span gas introduction.

(7) Allow time for the analyzer response to stabilize. Stabilization time may include time to purge the NMC and to account for the analyzer's response.

(8) While the analyzer measures a stable concentration, record 30 seconds of sampled data. Calculate the arithmetic mean of the analytical gas mixture.

(9) Divide the mean  $C_2H_6$  concentration by the reference concentration of  $C_2H_6$ , converted to a  $C_1$  basis. The result is the combined  $C_2H_6$  response factor and  $C_2H_6$  penetration fraction,  $RFPF_{C_2H_6[NMC-FID]}$ . Use this combined  $C_2H_6$  response factor and penetration fraction according to § 1065.660(b)(2)(iii) and (d)(1)(iii).

(10) Introduce the  $CH_4$  analytical gas mixture upstream of the NMC. Use good engineering judgment to address the effect of hydrocarbon contamination if your point of introduction is vastly different from the point of zero/span gas introduction.

(11) Allow time for the analyzer response to stabilize. Stabilization time may include time to purge the NMC and to account for the analyzer's response.

(12) While the analyzer measures a stable concentration, record 30 seconds of sampled data. Calculate the arithmetic mean of these data points.

(13) Reroute the flow path to bypass the NMC, introduce the  $CH_4$  analytical gas mixture, and repeat the steps in paragraphs (e)(11) and (12) of this section.

(14) Divide the mean  $CH_4$  concentration measured through the NMC by the mean  $CH_4$  concentration measured after bypassing the NMC. The result is the  $CH_4$  penetration fraction,  $PF_{CH_4[NMC-FID]}$ . Use this  $CH_4$  penetration fraction according to § 1065.660(b)(2)(iii) and (d)(1)(iii).

(g) *Test gas humidification.* If you are generating gas mixtures as a function of the molar water concentration in the raw or diluted exhaust according to paragraph (d) of this section, create a humidified test gas by bubbling the analytical gas mixture that meets the specifications in § 1065.750 through distilled  $H_2O$  in a sealed vessel or use a device that introduces distilled  $H_2O$  as vapor into a controlled gas flow. Determine the mole fraction of  $H_2O$  in the humidified calibration gas,  $\chi_{H_2Oref}$ , as an average value over intervals of at least 30 seconds. We recommend that you design your system to maintain temperatures at least 5 °C above the local calibration gas dewpoint in any transfer lines, fittings, and valves between the point at which you determine  $\chi_{H_2Oref}$  and the analyzer. Verify the humidity generator's uncertainty upon initial installation, within 370 days before verifying response factors and penetration fractions, and after major maintenance. Use the uncertainties from the

calibration of the humidity generator's measurements and follow NIST Technical Note 1297 (incorporated by reference, see § 1065.1010) to verify that the amount of H<sub>2</sub>O in X<sub>H<sub>2</sub>Oref</sub> is determined within ±3% uncertainty, U<sub>X<sub>H<sub>2</sub>O</sub></sub>, for one of the options described in § 1065.750(a)(6). If the humidity generator requires assembly before use, after assembly follow the instrument manufacturer's instructions to check for leaks.

(1) If the sample does not pass through a dryer during emission testing, generate at least five different H<sub>2</sub>O concentrations that cover the range from less than the minimum expected to greater than the maximum expected water concentration during testing. Use good engineering judgment to determine the target concentrations.

(2) If the sample passes through a dryer during emission testing, humidify your test gas to an H<sub>2</sub>O level at or above the level determined in § 1065.145(e)(2) for that dryer and determine a single wet analyzer response to the dehumidified sample.

■ 144. Amend § 1065.366 by revising paragraph (b) to read as follows:

**§ 1065.366 Interference verification for FTIR analyzers.**

\* \* \* \* \*

(b) *Measurement principles.* Certain species can interfere with analyzers by causing a response similar to the target analyte. If the analyzer uses compensation algorithms that utilize measurements of other gases to meet this interference verification, a correct result depends on simultaneously conducting these other measurements to test the compensation algorithms during the analyzer interference verification.

\* \* \* \* \*

■ 145. Amend § 1065.369 by revising paragraph (b) to read as follows:

**§ 1065.369 H<sub>2</sub>O, CO, and CO<sub>2</sub> interference verification for photoacoustic alcohol analyzers.**

\* \* \* \* \*

(b) *Measurement principles.* H<sub>2</sub>O, CO, and CO<sub>2</sub> can positively interfere with a photoacoustic analyzer by causing a response similar to ethanol or methanol. If the photoacoustic analyzer uses compensation algorithms that utilize measurements of other gases to meet this interference verification, a correct result depends on simultaneously conducting these other measurements to test the compensation algorithms during the analyzer interference verification.

\* \* \* \* \*

■ 146. Amend § 1065.372 by revising paragraphs (b) and (d)(7) and adding

paragraphs (d)(8) and (e)(2) to read as follows:

**§ 1065.372 NDUV analyzer HC and H<sub>2</sub>O interference verification.**

\* \* \* \* \*

(b) *Measurement principles.* Hydrocarbons and H<sub>2</sub>O can positively interfere with an NDUV analyzer by causing a response similar to NO<sub>x</sub>. If the NDUV analyzer uses compensation algorithms that utilize measurements of other gases to meet this interference verification, a correct result depends on simultaneously conducting such measurements to test the algorithms during the analyzer interference verification.

\* \* \* \* \*

(d) \* \* \*  
 (7) Multiply this difference by the ratio of the flow-weighted mean HC concentration expected at the standard to the HC concentration measured during the verification.

(8) The analyzer meets the interference verification of this section if the result of paragraph (d)(7) of this section meets the tolerance in paragraph (c) of this section.

(e) \* \* \*

(2) You may use a NO<sub>x</sub> NDUV analyzer that you determine does not meet this verification, as long as you try to correct the problem and the measurement deficiency does not adversely affect your ability to show that engines comply with all applicable emission standards.

■ 147. Amend § 1065.375 by revising paragraphs (a), (b), and (d)(3) and (9) to read as follows:

**§ 1065.375 Interference verification for N<sub>2</sub>O analyzers.**

(a) *Scope and frequency.* This section describes how to perform interference verification for certain analyzers as described in § 1065.275. Perform interference verification after initial analyzer installation and after major maintenance.

(b) *Measurement principles.* Certain species can positively interfere with analyzers by causing a response similar to N<sub>2</sub>O. If the analyzer uses compensation algorithms that utilize measurements of other gases to meet this interference verification, a correct result depends on simultaneously conducting these other measurements to test the compensation algorithms during the analyzer interference verification.

\* \* \* \* \*

(d) \* \* \*

(3) Introduce the humidified interference test gas into the sample system upstream or downstream of any

sample dryer, if one is used during testing.

\* \* \* \* \*

(9) You may also run interference procedures separately for individual interference species. If the concentrations of the interference species used are higher than the maximum levels expected during testing, you may scale down each observed interference value (the arithmetic mean of 30 second data described in paragraph (d)(7) of this section) by multiplying the observed interference by the ratio of the maximum expected concentration value to the actual value used during this procedure. You may run separate interference concentrations of H<sub>2</sub>O (down to 0.025 mol/mol H<sub>2</sub>O content) that are lower than the maximum levels expected during testing, but you must scale up the observed H<sub>2</sub>O interference by multiplying the observed interference by the ratio of the maximum expected H<sub>2</sub>O concentration value to the actual value used during this procedure. The sum of the scaled interference values must meet the tolerance for combined interference as specified in paragraph (c) of this section.

■ 148. Add § 1065.377 to read as follows:

**§ 1065.377 Interference verification for NH<sub>3</sub> analyzers.**

(a) *Scope and frequency.* This section describes how to perform interference verification for certain analyzers as described in § 1065.277. Perform interference verification after initial analyzer installation and after major maintenance.

(b) *Measurement principles.* Certain compounds can positively interfere with analyzers by causing a response similar to NH<sub>3</sub>. If the analyzer uses compensation algorithms that utilize measurements of other gases to meet this interference verification, a correct result depends on simultaneously conducting these other measurements to test the compensation algorithms during the analyzer interference verification.

(c) *System requirements.* Analyzers must have combined interference that is within (0.0 ± 2.0) μmol/mol.

(d) *Procedure.* Perform the interference verification as follows:

(1) Start, operate, zero, and span the NH<sub>3</sub> analyzer as you would before an emission test. If the sample is passed through a dryer during emission testing, you may run this verification test with the dryer if it meets the requirements of § 1065.342. Operate the dryer at the same conditions as you will for an emission test. You may also run this

verification test without the sample dryer.

(2) Except as specified in paragraph (d)(9) of this section, select a multi-component span gas meeting the specification of § 1065.750 that incorporates the all the appropriate interference species. Use a humidity generator that meets the requirements in § 1065.750(a)(6) to humidify the span gas. If the sample does not pass through a dryer during emission testing, humidify your test gas to an H<sub>2</sub>O level at or above the maximum expected during emission testing. If the sample passes through a dryer during emission testing, humidify your test gas to an H<sub>2</sub>O level at or above the level determined in § 1065.145(e)(2) for that dryer. Use interference span gas concentrations that are at least as high as the maximum expected during testing.

(3) Introduce the humidified interference test gas into the sample system upstream or downstream of any sample dryer, if one is used during testing.

(4) If the sample does not pass through a dryer during this verification test, measure the H<sub>2</sub>O mole fraction,  $\chi_{H_2O}$ , of the humidified interference test gas as close as possible to the analyzer inlet. You may measure dewpoint,  $T_{dew}$ , and absolute pressure,  $p_{total}$ , to calculate  $\chi_{H_2O}$ . Verify that the H<sub>2</sub>O content meets the requirement in paragraph (d)(2) of this section. If the sample passes through a dryer during this verification test, either measure dewpoint,  $T_{dew}$ , and absolute pressure,  $p_{total}$ , to calculate  $\chi_{H_2O}$  or use good engineering judgment to estimate the value of  $\chi_{H_2O}$  based on the vessel pressure and temperature. For example, you may use previous direct measurements of H<sub>2</sub>O content at certain vessel pressures and temperatures to estimate  $\chi_{H_2O}$ .

(5) If the verification procedure does not include a sample dryer, use good engineering judgment to prevent condensation in the transfer lines, fittings, or valves between the point of  $\chi_{H_2O}$  measurement and the analyzer. We recommend that you design your system so that the wall temperatures in those transfer lines, fittings, and valves are at least 5 °C above the local sample gas dewpoint.

(6) Allow time for the analyzer response to stabilize. Stabilization time may include time to purge the transfer line and to account for analyzer response.

(7) Operate the analyzer to measure the sample's NH<sub>3</sub> concentration and record results for 30 seconds. Calculate the arithmetic mean of these data to determine the interference value. When performed with all the interference

species simultaneously, this is the combined interference.

(8) The analyzer meets the interference verification if the result of paragraph (d)(7) of this section meets the tolerance in paragraph (c) of this section.

(9) You may instead perform interference verification procedures separately for individual interference species. The interference verification specified in paragraph (c) of this section applies based on the sum of the interference values from separate interference species. If the concentration of any interference species used is higher than the maximum levels expected during testing, you may scale down each observed interference value by multiplying the observed interference value by the ratio of the maximum expected concentration value to the concentration in the span gas. You may run separate H<sub>2</sub>O interference concentrations (down to 0.025 mol/mol H<sub>2</sub>O content) that are lower than the maximum levels expected during testing, but you must scale up the observed H<sub>2</sub>O interference value by multiplying the observed interference value by the ratio of the maximum expected H<sub>2</sub>O concentration value to the concentration in the span gas. The sum of the scaled interference values must meet the tolerance for combined interference as specified in paragraph (c) of this section.

■ 149. Amend § 1065.378 by adding paragraphs (e)(2) and (3) to read as follows:

**§ 1065.378 NO<sub>2</sub>-to-NO converter conversion verification.**

\* \* \* \* \*

(e) \* \* \*

(2) You may use a converter that you determine does not meet this verification, as long as you try to correct the problem and the measurement deficiency does not adversely affect your ability to show that engines comply with all applicable emission standards.

(3) You may request to verify converter conversion efficiency using an NO<sub>2</sub> concentration whose value is representative of the peak total NO<sub>2</sub> concentration expected during testing, in place of the procedure in paragraph (d) of this section, with our approval.

■ 150. Amend § 1065.510 by revising paragraphs (a) introductory text, (b), (d)(5)(i) and (iii), and (f) to read as follows:

**§ 1065.510 Engine mapping.**

(a) *Applicability, scope, and frequency.* An engine map is a data set that consists of a series of paired data

points that represent the maximum brake torque versus engine speed, measured at the engine's primary output shaft. Map your engine if the standard-setting part requires engine mapping to generate a duty cycle for your engine configuration. Map your engine while it is connected to a dynamometer or other device that can absorb work output from the engine's primary output shaft according to § 1065.110. Configure any auxiliary work inputs and outputs such as hybrid, turbo-compounding, or thermoelectric systems to represent their in-use configurations and use the same configuration for emission testing. See figure 1 to paragraph (a)(5) of § 1065.210. This may involve configuring initial states of charge and rates and times of auxiliary-work inputs and outputs. We recommend that you contact the EPA Program Officer before testing to determine how you should configure any auxiliary-work inputs and outputs. If your engine has an auxiliary emission control device to reduce torque output that may activate during engine mapping, turn it off before mapping. Use the most recent engine map to transform a normalized duty cycle from the standard-setting part to a reference duty cycle specific to your engine. Normalized duty cycles are specified in the standard-setting part. You may update an engine map at any time by repeating the engine-mapping procedure. You must map or re-map an engine before a test if any of the following apply:

\* \* \* \* \*

(b) *Mapping variable-speed engines.* Map variable-speed engines using the procedure in this paragraph (b). Note that under § 1065.10(c) we may allow or require you to use "other procedures" if the specified procedure results in unrepresentative testing or if your engine cannot be tested using the specified procedure. If the engine has a user-adjustable idle speed setpoint, you may set it to its minimum adjustable value for this mapping procedure and the resulting map may be used for any test, regardless of where it is set for running each test except that the warm idle speed(s) must be determined based on where it is set for running each test.

(1) Record the atmospheric pressure.

(2) Warm up the engine by operating it. We recommend operating the engine at any speed and at approximately 75% of its expected maximum power. Continue the warm-up until the engine coolant, block, lubricating oil, or head absolute temperature is within ±2% of its mean value for at least 2 min or until the engine thermostat controls engine temperature.

(3) Operate the engine at its warm idle speed as follows:

(i) For engines with a low-speed governor, set the operator demand to minimum, use the dynamometer or other loading device to target a torque of zero or the lowest idle load that you will use for cycle generation on the engine's primary output shaft, and allow the engine to govern the speed. If the idle load is a function of engine speeds (e.g., the optional declared power from paragraph (f)(6) of this section), calculate the target torque in real time. Measure this warm idle speed; we recommend recording at least 30 values of speed and using the mean of those values. If you identify multiple warm idle loads under paragraph (f)(4), (f)(5)(iii), or (f)(6) of this section, measure the warm idle speed at the lowest torque level for this paragraph (b)(3). Measure the other warm idle speeds as described in paragraph (b)(7) of this section.

(ii) For engines without a low-speed governor, operate the engine at warm idle speed from paragraph (f)(2) of this section and zero torque or the lowest warm idle torque that you will use for cycle generation on the engine's primary output shaft. You may use the dynamometer to control either torque or speed and manipulate the operator demand to control the other parameter.

(4) Operate the engine at the minimum mapped speed. A minimum mapped speed equal to  $(95 \pm 1)\%$  of its warm idle speed determined in paragraph (b)(3) of this section may be used for any engine or test. A higher minimum mapped speed may be used if all the duty cycles that the engine is subject to have a minimum reference speed higher than the warm idle speed determined in paragraph (b)(3) of this section. In this case you may use a minimum mapped speed equal to  $(95 \pm 1)\%$  of the lowest minimum reference speed in all the duty cycles the engine is subject to. Set operator demand to maximum and control engine speed at this minimum mapped speed for at least 15 seconds. Set operator demand to maximum and control engine speed at  $(95 \pm 1)\%$  of its warm idle speed determined in paragraph (b)(3)(i) of this section for at least 15 seconds.

(5) Perform a continuous or discrete engine map as described in paragraph (b)(5)(i) or (ii) of this section. A continuous engine map may be used for any engine. A discrete engine map may be used for engines subject only to steady-state duty cycles. Use linear interpolation between the series of points generated by either of these maps to determine intermediate torque values. Use the series of points generated by

either of these maps to generate the power map as described in paragraph (e) of this section.

(i) For continuous engine mapping, begin recording mean feedback speed and torque at 1 Hz or more frequently and increase speed at a constant rate such that it takes (4 to 6) min to sweep from the minimum mapped speed described in paragraph (b)(4) of this section to the check point speed described in paragraph (b)(5)(iii) of this section. Use good engineering judgment to determine when to stop recording data to ensure that the sweep is complete. In most cases, this means that you can stop the sweep at any point after the power falls to 50% of the maximum value.

(ii) For discrete engine mapping, select at least 20 evenly spaced setpoints from the minimum mapped speed described in paragraph (b)(4) of this section to the check point speed described in paragraph (b)(5)(iii) of this section. At each setpoint, stabilize speed and allow torque to stabilize. We recommend that you stabilize an engine for at least 15 seconds at each setpoint and record the mean feedback speed and torque of the last (4 to 6) seconds. Record the mean speed and torque at each setpoint.

(iii) The check point speed of the map is the highest speed above maximum power at which 50% of maximum power occurs. If this speed is unsafe or unachievable (e.g., for ungoverned engines or engines that do not operate at that point), use good engineering judgment to map up to the maximum safe speed or maximum achievable speed. For discrete mapping, if the engine cannot be mapped to the check point speed, make sure the map includes at least 20 points from 95% of warm idle to the maximum mapped speed. For continuous mapping, if the engine cannot be mapped to the check point speed, verify that the sweep time from 95% of warm idle to the maximum mapped speed is (4 to 6) min.

(iv) Note that under § 1065.10(c)(1) we may allow you to disregard portions of the map when selecting maximum test speed if the specified procedure would result in a duty cycle that does not represent in-use operation.

(6) Determine warm high-idle speed for engines with a high-speed governor. You may skip this if the engine is not subject to transient testing with a duty cycle that includes reference speed values above 100%. You may use a manufacturer-declared warm high-idle speed if the engine is electronically governed. For engines with a high-speed governor that regulates speed by disabling and enabling fuel or ignition

at two manufacturer-specified speeds, declare the middle of this specified speed range as the warm high-idle speed. You may alternatively measure warm high-idle speed using the following procedure:

(i) Run an operating point targeting zero torque.

(A) Set operator demand to maximum and use the dynamometer to target zero torque on the engine's primary output shaft.

(B) Wait for the engine governor and dynamometer to stabilize. We recommend that you stabilize for at least 15 seconds.

(C) Record 1 Hz means of the feedback speed and torque for at least 30 seconds. You may record means at a higher frequency as long as there are no gaps in the recorded data. For engines with a high-speed governor that regulates speed by disabling and enabling fuel or ignition, you may need to extend this stabilization period to include at least one disabling event at the higher speed and one enabling event at the lower speed.

(D) Determine if the feedback speed is stable over the recording period. The feedback speed is considered stable if all the recorded 1 Hz means are within  $\pm 2\%$  of the mean feedback speed over the recording period. If the feedback speed is not stable because of the dynamometer, void the results and repeat measurements after making any necessary corrections. You may void and repeat the entire map sequence, or you may void and replace only the results for establishing warm high-idle speed; use good engineering judgment to warm-up the engine before repeating measurements.

(E) If the feedback speed is stable, use the mean feedback speed over the recording period as the measured speed for this operating point.

(F) If the feedback speed is not stable because of the engine, determine the mean as the value representing the midpoint between the observed maximum and minimum recorded feedback speed.

(G) If the mean feedback torque over the recording period is within  $(0 \pm 1)\%$  of  $T_{\text{maxmapped}}$ , use the measured speed for this operating point as the warm high-idle speed. Otherwise, continue testing as described in paragraph (b)(6)(ii) of this section.

(ii) Run a second operating point targeting a positive torque. Follow the same procedure in paragraphs (b)(6)(i)(A) through (F) of this section, except that the dynamometer is set to target a torque equal to the mean feedback torque over the recording

period from the previous operating point plus 20% of  $T_{max}$  mapped.

(iii) Use the mean feedback speed and torque values from paragraphs (b)(6)(i) and (ii) of this section to determine the warm high-idle speed. If the two recorded speed values are the same, use that value as the warm high-idle-speed. Otherwise, use a linear equation passing through these two speed-torque points and extrapolate to solve for the speed at zero torque and use this speed intercept value as the warm high-idle speed.

(iv) You may use a manufacturer-declared  $T_{max}$  instead of the measured  $T_{max}$  mapped. If you do this, you may also measure the warm high-idle speed as described in this paragraph (b)(6) before running the operating point and speed sweeps specified in paragraphs (b)(4) and (5) of this section.

(7) This paragraph (b)(7) describes how to collect additional data to determine warm idle speed(s) for cycle generation if your engine has a low-speed governor. You may omit this paragraph (b)(7) if you use the option to declare a warm idle speed in paragraph (f)(3)(iv) of this section, or if you identify only one idle load and one user-adjustable idle speed setpoint under paragraph (b)(3)(i) of this section. Collect additional data to determine warm idle speed(s) using one of the following options:

(i) For each idle load (e.g., idle with the transmission in neutral and drive) you identify under paragraph (f)(4), (f)(5)(iii), or (f)(6) of this section, operate the engine at each idle load and measure the warm idle speed at each idle load as described in paragraph (b)(3)(i) of this section. The warm idle operating point run in paragraph (b)(3)(i) of this section may be skipped and the measured warm idle speed from paragraph (b)(3)(i) of this section may be used for cycle generation for cycles where the user-adjustable idle speed setpoint is the same. Note that this option requires you to know all the idle loads in all the cycles that will be generated with this map at the time the map is run.

(ii) You may map the idle governor at multiple torque levels and use this map to determine the warm idle speed(s) at any idle load within the range of this map. For cases where the idle torque is a function of engine speeds (e.g., if CITT is specified as a function of speed or if the optional declared power in paragraph (f)(6) of this section applies) we recommend that the warm idle speed be determined using a closed form solution assuming speed and torque vary linearly between points in this map. If an iterative method is used,

continue to iterate until the value is within  $\pm 0.0001\%$  of the previous value.

(8) This paragraph (b)(8) describes how to collect additional data to determine warm idle speed(s) for cycle generation if your engine has a low-speed governor and a user-adjustable idle speed setpoint and you need to generate cycles for tests with a different setpoint from the setpoint used in this mapping procedure. You may omit this paragraph (b)(8) if you use the option to declare a warm idle speed in paragraph (f)(3)(iv) of this section. Collect additional data using paragraph (b)(7) of this section to determine the warm idle speed for each setpoint for use in generating cycles. Record the warm idle speed and torque for each setpoint.

\* \* \* \* \*

(d) \* \* \*

(5) \* \* \*

(i) For constant-speed engines subject only to steady-state testing, you may perform an engine map by using a series of discrete torques. Select at least five evenly spaced torque setpoints from no-load to 80% of the manufacturer-declared test torque or to a torque derived from your published maximum power level if the declared test torque is unavailable. Starting at the 80% torque point, select setpoints in 2.5% or smaller intervals, stopping at the endpoint torque. The endpoint torque is defined as the first discrete mapped torque value greater than the torque at maximum observed power where the engine outputs 90% of the maximum observed power; or the torque when engine stall has been determined using good engineering judgment (i.e., sudden deceleration of engine speed while adding torque). You may continue mapping at higher torque setpoints. At each setpoint, allow torque and speed to stabilize. Record the mean feedback speed and torque at each setpoint. From this series of mean feedback speed and torque values, use linear interpolation to determine intermediate values. Use this series of mean feedback speeds and torques to generate the power map as described in paragraph (e) of this section.

\* \* \* \* \*

(iii) For any isochronous governed (no speed droop) constant-speed engine, you may map the engine with two points as described in this paragraph (d)(5)(iii). After stabilizing at the no-load, or minimum achievable load, governed speed in paragraph (d)(4) of this section, record the mean feedback speed and torque. Continue to operate the engine with the governor or simulated governor controlling engine speed using operator demand and

control the dynamometer to target a speed of 99.5% of the recorded mean no-load governed speed. Allow speed and torque to stabilize. Record the mean feedback speed and torque. Record the target speed. The absolute value of the speed error (the mean feedback speed minus the target speed) must be no greater than 0.1% of the recorded mean no-load governed speed. From this series of two mean feedback speed and torque values, use linear interpolation to determine intermediate values. Use this series of two mean feedback speeds and torques to generate a power map as described in paragraph (e) of this section. Note that the measured maximum test torque as determined in § 1065.610(b)(1) will be the mean feedback torque recorded on the second point.

\* \* \* \* \*

(f) *Measured and declared speeds, torques, and power.* You must select speeds, torques, and power for engine mapping and for cycle generation as required in this paragraph (f). “Measured” values are either directly measured during the engine mapping process or they are determined from the engine map. “Declared” values are specified by the manufacturer. When both measured and declared values are available, you may use declared test speeds and torques instead of measured speeds and torques if they meet the criteria in this paragraph (f). Otherwise, you must use measured speeds and torques derived from the engine map.

(1) *Measured speeds and torques.* Determine the applicable speeds and torques for the duty cycles you will run:

(i) Measured maximum test speed for variable-speed engines according to § 1065.610.

(ii) Measured maximum test torque for constant-speed engines according to § 1065.610.

(iii) Measured “A”, “B”, and “C” speeds for variable-speed engines according to § 1065.610.

(iv) Measured intermediate speed for variable-speed engines according to § 1065.610.

(v) For variable-speed engines with a low-speed governor, measure warm idle speed(s) according to paragraph (b) of this section and use this (these) speed(s) for cycle generation in § 1065.512. For engines with no low-speed governor, instead use the manufacturer-declared warm idle speed from paragraph (f)(2) of this section.

(2) *Required declared speeds.* You must declare the lowest engine speed possible with minimum load (i.e., manufacturer-declared warm idle speed). This is applicable only to



variable-speed engines with no low-speed governor. For engines with no low-speed governor, the declared warm idle speed is used for cycle generation in § 1065.512. Declare this speed in a way that is representative of in-use operation. For example, if your engine is typically connected to an automatic transmission or a hydrostatic transmission, declare this speed at the idle speed at which your engine operates when the transmission is engaged.

(3) *Optional declared speeds.* You may use declared speed instead of measured speed as follows:

(i) You may use a declared value for maximum test speed for variable-speed engines if it is within (97.5 to 102.5)% of the corresponding measured value. You may use a higher declared speed if the length of the “vector” at the declared speed is within 2% of the length of the “vector” at the measured value. The term vector refers to the square root of the sum of normalized engine speed squared and the normalized full-load power (at that speed) squared, consistent with the calculations in § 1065.610.

(ii) You may use a declared value for intermediate, “A”, “B”, or “C” speeds for steady-state tests if the declared value is within (97.5 to 102.5)% of the corresponding measured value.

(iii) For electronically governed variable-speed engines, you may use a declared warm high-idle speed for calculating the alternate maximum test speed as specified in § 1065.610.

(iv) For electronically governed variable-speed engines with an isochronous low-speed governor (*i.e.*, no speed droop), you may declare that the warm idle speed is equal to the idle speed setpoint and use it for cycle generation instead of warm idle speed(s) determined from the data collected during the engine mapping procedure in paragraph (b) of this section. When generating cycles with multiple idle torque values, you may use this idle speed setpoint for all idle points. If the idle torque is a function of speed (*e.g.*, CITT is specified as a function of speed or if the optional declared power in paragraph (f)(6) of this section applies) use the setpoint to calculate the idle torque(s) for cycle generation. If the engine has a user-adjustable idle speed setpoint, generate the cycle using the idle speed setpoint that will be set when the engine is run for that cycle.

(4) *Required declared torque.* For variable-speed engines intended primarily for propulsion of a vehicle with an automatic transmission where that engine is subject to a transient duty cycle with idle operation, you must

declare a Curb-Idle Transmission Torque (CITT). We recommend that you specify CITT as a function of idle speed for engines with adjustable warm idle or enhanced-idle. You may specify a CITT based on typical applications at the mean of the range of idle speeds you specify at stabilized temperature conditions. See the required deviations for cycle generation in § 1065.610(d)(3) for how the required declared CITT and the optional declared torque in paragraph (f)(5)(iii) of this section and the optional declared power in paragraph (f)(6) of this section are used in cycle generation.

(5) *Optional declared torques.* You may use declared torque instead of measured torque as follows:

(i) For variable-speed engines you may declare a maximum torque over the engine operating range. You may use the declared value for measuring warm high-idle speed as specified in this section.

(ii) For constant-speed engines you may declare a maximum test torque. You may use the declared value for cycle generation if it is within (95 to 100)% of the measured value. (iii) For variable-speed engines, you may declare a nonzero torque for idle operation that represents in-use operation. For example, if your engine is connected to a hydrostatic transmission with a minimum torque even when all the driven hydraulic actuators and motors are stationary and the engine is at idle, you may use this minimum torque as the declared value. As another example, if your engine is connected to a vehicle or machine with accessories, you may use a declared torque corresponding to operation with those accessories. You may specify a combination of torque and power as described in paragraph (f)(6) of this section. Use this option when the idle loads (*e.g.*, vehicle accessory loads) are best represented as a constant torque on the primary output shaft. You may use multiple warm idle loads and associated idle speeds in cycle generation for representative testing. As an example, see the required deviations for cycle generation in § 1065.610(d)(3) for improved simulation of idle points for engines intended primarily for propulsion of a vehicle with an automatic or manual transmission where that engine is subject to a transient duty cycle with idle operation.

(iv) For constant-speed engines, you may declare a warm minimum torque that represents in-use operation. For example, if your engine is typically connected to a machine that does not operate below a certain minimum torque, you may use this minimum

torque as the declared value and use it for cycle generation.

(6) *Optional declared power.* For variable-speed engines, you may declare a nonzero power for idle operation that represents in-use operation. If you specify a torque in paragraph (f)(5)(iii) of this section and a power in this paragraph (f)(6), the combination of declared values must represent in-use operation and you must use the combination for cycle generation. Use the combination of declared values when the idle loads (*i.e.*, vehicle accessory loads) are best represented as a constant power.

\* \* \* \* \*

■ 151. Amend § 1065.512 by revising paragraphs (b)(1) and (2) to read as follows:

**§ 1065.512 Duty cycle generation.**

\* \* \* \* \*

(b) \* \* \*

(1) *Engine speed for variable-speed engines.* For variable-speed engines, normalized speed may be expressed as a percentage between warm idle speed,  $f_{idle}$ , and maximum test speed,  $f_{ntest}$ , or speed may be expressed by referring to a defined speed by name, such as “warm idle,” “intermediate speed,” or “A,” “B,” or “C” speed. Section 1065.610 describes how to transform these normalized values into a sequence of reference speeds,  $f_{nref}$ . Running duty cycles with negative or small normalized speed values near warm idle speed may cause low-speed idle governors to activate and the engine torque to exceed the reference torque even though the operator demand is at a minimum. In such cases, we recommend controlling the dynamometer so it gives priority to follow the reference torque instead of the reference speed and let the engine govern the speed. Note that the cycle-validation criteria in § 1065.514 allow an engine to govern itself. This allowance permits you to test engines with enhanced-idle devices and to simulate the effects of transmissions such as automatic transmissions. For example, an enhanced-idle device might be an idle speed value that is normally commanded only under cold-start conditions to quickly warm up the engine and aftertreatment devices. In this case, negative and very low normalized speeds will generate reference speeds below this higher enhanced-idle speed. You may do any of the following when using enhanced-idle devices:

(i) While running an engine where the ECM broadcasts an enhanced-idle speed that is above the denormalized speed,

use the broadcast speed as the reference speed. Use these new reference points for duty-cycle validation. This does not affect how you determine denormalized reference torque in paragraph (b)(2) of this section.

(ii) If an ECM broadcast signal is not available, perform one or more practice cycles to determine the enhanced-idle speed as a function of cycle time. Generate the reference cycle as you normally would but replace any reference speed that is lower than the enhanced-idle speed with the enhanced-idle speed. This does not affect how you determine denormalized reference torque in paragraph (b)(2) of this section.

(2) *Engine torque for variable-speed engines.* For variable-speed engines, normalized torque is expressed as a percentage of the mapped torque at the corresponding reference speed. Section 1065.610 describes how to transform normalized torques into a sequence of reference torques,  $T_{ref}$ . Section 1065.610 also describes special requirements for modifying transient duty cycles for variable-speed engines intended primarily for propulsion of a vehicle with an automatic or manual transmission. Section 1065.610 also describes under what conditions you may command  $T_{ref}$  greater than the reference torque you calculated from a normalized duty cycle, which permits you to command  $T_{ref}$  values that are limited by a declared minimum torque. For any negative torque commands, command minimum operator demand and use the dynamometer to control engine speed to the reference speed, but if reference speed is so low that the idle governor activates, we recommend using the dynamometer to control torque to zero, CITT, or a declared minimum torque as appropriate. Note that you may omit power and torque points during motoring from the cycle-validation criteria in § 1065.514. Also, use the maximum mapped torque at the minimum mapped speed as the maximum torque for any reference speed at or below the minimum mapped speed.

\* \* \* \* \*

- 152. Amend § 1065.520 by:
  - a. Redesignating paragraph (f) as paragraph (g);
  - b. Adding new paragraph (f); and
  - c. Revising newly redesignated paragraphs (g) introductory text and (g)(7)(iii).

The addition and revisions read as follows:

**§ 1065.520 Pre-test verification procedures and pre-test data collection.**

\* \* \* \* \*

(f) If your testing requires a chemical balance, then before the start of emissions testing select the chemical balance method and the gaseous emission measurement equipment required for testing. Select the chemical balance method depending on the fuels used during testing:

(1) When using only carbon-containing fuels, use the carbon-based chemical balance procedure in § 1065.655.

(2) When using only fuels other than carbon-containing fuels, use the hydrogen-based chemical balance procedure in § 1065.656.

(3) When using constant mixtures of carbon-containing fuels and fuels other than carbon-containing fuels, use the following chemical balance methods and gaseous emission measurement equipment:

(i) If the hydrogen-to-carbon ratio,  $\alpha$ , of the fuel mixture is less than or equal to 6, then use the carbon-based chemical balance procedure in § 1065.655.

(ii) Otherwise, use the hydrogen-based chemical balance procedure in § 1065.656.

(4) When using variable mixtures of carbon-containing fuels and fuels other than carbon-containing fuels, if the mean hydrogen-to-carbon ratio of the fuel mixture,  $\alpha$ , is expected to be greater than 6 for a test interval, you must use the hydrogen-based chemical balance procedure in § 1065.656 for that test interval. Otherwise, you may use the carbon-based chemical balance procedure in § 1065.655.

(g) If your testing requires measuring hydrocarbon emissions, verify the amount of nonmethane hydrocarbon contamination in the exhaust and background HC sampling systems within 8 hours before the start of the first test interval of each duty-cycle sequence for laboratory tests. You may verify the contamination of a background HC sampling system by reading the last bag fill and purge using zero gas. For any NMHC measurement system that involves separately measuring CH<sub>4</sub> and subtracting it from a THC measurement or for any CH<sub>4</sub> measurement system that uses an NMC, verify the amount of THC contamination using only the THC analyzer response. There is no need to operate any separate CH<sub>4</sub> analyzer for this verification; however, you may measure and correct for THC contamination in the CH<sub>4</sub> sample path for the cases where NMHC is determined by subtracting CH<sub>4</sub> from THC or, where CH<sub>4</sub> is determined, using an NMC as configured in § 1065.365(d), (e), and (f); and using the calculations in

§ 1065.660(b)(2). Perform this verification as follows:

\* \* \* \* \*

(7) \* \* \*

(iii) Use mean analyzer values from paragraphs (g)(2) and (3) and (g)(7)(i) and (ii) of this section to correct the initial THC concentration recorded in paragraph (g)(6) of this section for drift, as described in § 1065.550.

\* \* \* \* \*

- 153. Amend § 1065.530 by revising paragraphs (a)(2)(ii), (a)(2)(iii)(A), and (b)(4), (9), and (11) to read as follows:

**§ 1065.530 Emission test sequence.**

(a) \* \* \*

(2) \* \* \*

(ii) For hot-start duty cycles, first operate the engine at any speed above peak-torque speed and at (65 to 85)% of maximum mapped power until either the engine coolant, block, lubricating oil, or head absolute temperature is within  $\pm 2\%$  of its mean value for at least 2 min or until the engine thermostat controls engine temperature. Shut down the engine. Start the duty cycle within 20 min of engine shutdown.

(iii) \* \* \*

(A) Engine coolant, block, lubricating oil, or head absolute temperatures for water-cooled engines.

\* \* \* \* \*

(b) \* \* \*

(4) Pre-heat or pre-cool heat exchangers in the sampling system to within their operating temperature tolerances for a test interval.

\* \* \* \* \*

(9) Select gas analyzer ranges. You may automatically or manually switch gas analyzer ranges during a test interval only if switching is performed by changing the span over which the digital resolution of the instrument is applied. During a test interval you may not switch the gains of an analyzer's analog operational amplifier(s).

\* \* \* \* \*

(11) We recommend that you verify gas analyzer responses after zeroing and spanning by sampling a calibration gas that has a concentration near one-half of the span gas concentration. Based on the results and good engineering judgment, you may decide whether or not to re-zero, re-span, or re-calibrate a gas analyzer before starting a test interval.

\* \* \* \* \*

- 154. Amend § 1065.550 by revising paragraphs (b) introductory text and (b)(3)(ii) to read as follows:

**§ 1065.550 Gas analyzer range verification and drift verification.**

\* \* \* \* \*

(b) *Drift verification.* Gas analyzer drift verification is required for all gaseous exhaust constituents for which an emission standard applies. It is also required for CO<sub>2</sub>, H<sub>2</sub>, O<sub>2</sub>, H<sub>2</sub>O, and NH<sub>3</sub>, if required by the applicable chemical balance, even if there are no emission standards. It is not required for other gaseous exhaust constituents for which only a reporting requirement applies (such as CH<sub>4</sub> and N<sub>2</sub>O).

\* \* \* \* \*

(3) \* \* \*

(ii) Where no emission standard applies for CO<sub>2</sub>, H<sub>2</sub>, O<sub>2</sub>, H<sub>2</sub>O, and NH<sub>3</sub>, you must satisfy one of the following:

(A) For each test interval of the duty cycle, the difference between the uncorrected and the corrected brake-specific CO<sub>2</sub>, H<sub>2</sub>, O<sub>2</sub>, H<sub>2</sub>O, or NH<sub>3</sub> values must be within ±4% of the uncorrected value; or the difference between the uncorrected and the corrected CO<sub>2</sub>, H<sub>2</sub>, O<sub>2</sub>, H<sub>2</sub>O, or NH<sub>3</sub> mass (or mass rate) values must be within ±4% of the uncorrected value.

(B) For the entire duty cycle, the difference between the uncorrected and the corrected composite brake-specific CO<sub>2</sub>, H<sub>2</sub>, O<sub>2</sub>, H<sub>2</sub>O, or NH<sub>3</sub> values must be within ±4% of the uncorrected value.

\* \* \* \* \*

■ 155. Amend § 1065.601 by revising paragraph (c)(1) to read as follows:

**§ 1065.601 Overview.**

\* \* \* \* \*

(c) \* \* \*

(1) Mass-based emission calculations prescribed by the International Organization for Standardization (ISO), according to ISO 8178, except the following:

(i) ISO 8178—4 Section 9.1.6, NO<sub>x</sub> Correction for Humidity and Temperature. See § 1065.670 for approved methods for humidity corrections.

(ii) [Reserved]

\* \* \* \* \*

■ 156. Amend § 1065.602 by adding paragraph (m) to read as follows:

**§ 1065.602 Statistics.**

\* \* \* \* \*

(m) *Median.* Determine median, *M*, as described in this paragraph (m). Arrange the data points in the data set in increasing order where the smallest value is ranked 1, the second-smallest value is ranked 2, etc.

(1) For even numbers of data points:

(i) Determine the rank of the data point whose value is used to determine the median as follows:

$$i = \frac{N}{2}$$

Eq. 1065.602–18

Where:

*i* = an indexing variable that represents the rank of the data point whose value is used to determine the median.

*N* = the number of data points in the set.

*Example:*

*N* = 4  
*y*<sub>1</sub> = 41.515  
*y*<sub>2</sub> = 41.780  
*y*<sub>3</sub> = 41.861  
*y*<sub>4</sub> = 41.902  
*i* = 2  
*i* = 2

(ii) Determine the median as the average of the data point *i* and the data point *i* + 1 as follows:

$$M = \frac{y_i + y_{i+1}}{2}$$

*Example:*

*y*<sub>2</sub> = 41.780  
*y*<sub>3</sub> = 41.861  
*M* =  $\frac{41.780 + 41.861}{2}$   
*M* = 41.821

Eq. 1065.602–19

(2) For odd numbers of data points, determine the rank of the data point whose value is the median and the corresponding median value as follows:

$$i = \frac{N + 1}{2}$$

Eq. 1065.602–20

Where:

*i* = an indexing variable that represents the rank of the data point whose value is the median.

*N* = the number of data points in the set.

*Example:*

*N* = 3  
*y*<sub>1</sub> = 41.515  
*y*<sub>2</sub> = 41.780  
*y*<sub>3</sub> = 41.861

$$i = \frac{3 + 1}{2}$$

$$i = 2$$

$$M = 41.780$$

■ 157. Amend § 1065.610 by revising paragraph (d)(3) to read as follows:

**§ 1065.610 Duty cycle generation.**

\* \* \* \* \*

(d) \* \* \*

(3) *Required deviations.* We require the following deviations for variable-speed engines intended primarily for

propulsion of a vehicle with an automatic or manual transmission where that engine is subject to a transient duty cycle that specifies points with normalized reference speed of 0% and normalized reference torque of 0% (*i.e.*, idle points). These deviations are intended to produce a more representative transient duty cycle for these applications. For steady-state duty cycles or transient duty cycles with no idle operation, the requirements in this paragraph (d)(3) do not apply. Idle points for steady-state duty cycles of such engines are to be run at conditions simulating neutral or park on the transmission. For manual transmissions, set CITT to zero, which results in warm-idle-in-drive speed and torque values being the same as warm-idle-in-neutral values. For the case of a manual transmission where the optional declared idle torque in § 1065.510(f)(5)(iii) and the optional declared power in § 1065.510(f)(6) are not declared (*i.e.*, idle torque is zero), the required deviations in this paragraph (d)(3) have no impact and may be skipped.

(i) Determine the warm-idle-in-drive speed and torque values with the transmission in drive from the data collected during the engine mapping procedure in § 1065.510. The warm-idle-in-drive torque is the sum of CITT and the torques representing loads from vehicle accessories. For example, the sum of the required declared CITT in § 1065.510(f)(4), any optional declared torque in § 1065.510(f)(5)(iii), and the torque on the primary output shaft from any optional declared power in § 1065.510(f)(6).

(ii) Determine the warm-idle-in-neutral speed and torque values with the transmission in neutral from the data collected during the engine mapping procedure in § 1065.510. The warm-idle-in-neutral torque is the sum of any optional declared torque in § 1065.510(f)(5)(iii) and the torque on the primary output shaft from any optional declared power in § 1065.510(f)(6) (*i.e.*, the sum of the torques representing loads from vehicle accessories).

(iii) Zero-percent speed for denormalization of non-idle points is the warm-idle-in-drive speed.

(iv) For motoring points, make no changes.

(v) If the cycle begins with an idle segment (*i.e.*, a set of one or more contiguous idle points), set the reference speed and torque values to the warm-idle-in-neutral values for this initial segment. This is to represent idle operation with the transmission in neutral or park at the start of the

transient duty cycle, after the engine is started. If the initial idle segment is longer than 24 seconds, change the reference speed and torque values for the remaining idle points in the initial idle segment to the warm-idle-in-drive values (*i.e.*, change idle points corresponding to 25 seconds to the end of the initial idle segment to warm-idle-in-drive). This is to represent manually shifting the transmission to drive.

(vi) For all other idle segments, set the reference speed and torque values to the warm-idle-in-drive values. This is to represent the transmission operating in drive.

(vii) If the engine is intended primarily for automatic transmissions with a Neutral-When-Stationary feature that automatically shifts the transmission to neutral after the vehicle is stopped for a designated time and automatically shifts back to drive when the operator increases demand (*i.e.*, pushes the accelerator pedal), reprocess all idle segments. Change reference speed and torque values from the warm-idle-in-drive values to the warm-idle-in-neutral values for idle points in drive after the designated time.

(viii) For all nonidle nonmotoring points with normalized speed at or below zero percent and reference torque from zero to the warm-idle-in-drive torque value, set the reference torque to

the warm-idle-in-drive torque value. This is to represent the transmission operating in drive.

(ix) For consecutive nonidle nonmotoring points that immediately follow and precede idle segments, with reference torque values from zero to the warm-idle-in-drive torque value, change their reference torques to the warm-idle-in-drive torque value. This is to represent the transmission operating in drive.

(x) For consecutive nonidle nonmotoring points that immediately follow and precede any point(s) that were modified in paragraph (d)(3)(viii) of this section, with reference torque values from zero to the warm-idle-in-drive torque value, change their reference torques to the warm-idle-in-drive torque value. This is to provide smooth torque transition around these points.

\* \* \* \* \*  
 ■ 158. Revise § 1065.644 to read as follows:

**§ 1065.644 Vacuum-decay leak rate.**

This section describes how to calculate the leak rate of a vacuum-decay leak verification, which is described in § 1065.345(e). Use the following equation to calculate the leak rate,  $\dot{n}_{leak}$ , and compare it to the criterion specified in § 1065.345(e):

$$\dot{n}_{leak} = \frac{V_{vac}}{R} \cdot \frac{\left(\frac{p_2}{T_2} - \frac{p_1}{T_1}\right)}{(t_2 - t_1)}$$

Eq. 1065.644–1

Where:

$V_{vac}$  = geometric volume of the vacuum-side of the sampling system.

$R$  = molar gas constant.

$p_2$  = vacuum-side absolute pressure at time  $t_2$ .

$T_2$  = vacuum-side absolute temperature at time  $t_2$ .

$p_1$  = vacuum-side absolute pressure at time  $t_1$ .

$T_1$  = vacuum-side absolute temperature at time  $t_1$ .

$t_2$  = time at completion of vacuum-decay leak verification test.

$t_1$  = time at start of vacuum-decay leak verification test.

Example:

$V_{vac} = 2.0000 \text{ L} = 0.00200 \text{ m}^3$

$R = 8.314472 \text{ J}/(\text{mol}\cdot\text{K}) = 8.314472 \text{ (m}^2\cdot\text{kg)} / (\text{s}^2\cdot\text{mol}\cdot\text{K})$

$p_2 = 50.600 \text{ kPa} = 50600 \text{ Pa} = 50600 \text{ kg}/(\text{m}\cdot\text{s}^2)$

$T_2 = 293.15 \text{ K}$

$p_1 = 25.300 \text{ kPa} = 25300 \text{ Pa} = 25300 \text{ kg}/(\text{m}\cdot\text{s}^2)$

$T_1 = 293.15 \text{ K}$

$t_2 = 10:57:35 \text{ a.m.}$

$t_1 = 10:56:25 \text{ a.m.}$

$$\dot{n}_{leak} = \frac{0.002}{8.314472} \cdot \frac{\left(\frac{50600}{293.15} - \frac{25300}{293.15}\right)}{(10:57:35 - 10:56:25)}$$

$$\dot{n}_{leak} = \frac{0.002}{8.314472} \cdot \frac{86.304}{70}$$

$$\dot{n}_{leak} = 0.00030 \text{ mol/s}$$

■ 159. Amend § 1065.650 by revising paragraph (c)(1)(ii) to read as follows:

**§ 1065.650 Emission calculations.**

\* \* \* \* \*

(c) \* \* \*

(1) \* \* \*

(ii) Correct all gaseous emission analyzer concentration readings, including continuous readings, sample bag readings, and dilution air background readings, for drift as described in § 1065.672. Note that you must omit this step where brake-specific emissions are calculated without the drift correction for performing the drift validation according to § 1065.550(b). When applying the initial THC and CH<sub>4</sub> contamination readings according to § 1065.520(g), use the same values for both sets of calculations. You may also

use as-measured values in the initial set of calculations and corrected values in the drift-corrected set of calculations as described in § 1065.520(g)(7).

\* \* \* \* \*

■ 160. Amend § 1065.655 by:

■ a. Revising the section heading and paragraphs (a), (b)(4), and (e)(1) and (4);

■ b. Removing the first paragraph (f)(3); and

■ c. Revising the second paragraph (f)(3).

The revisions read as follows:

**§ 1065.655 Carbon-based chemical balances of fuel, DEF, intake air, and exhaust.**

(a) *General.* Chemical balances of fuel, intake air, and exhaust may be used to calculate flows, the amount of water in their flows, and the wet concentration of

constituents in their flows. See § 1065.520(f) for information about when to use this carbon-based chemical balance procedure. With one flow rate of either fuel, intake air, or exhaust, you may use chemical balances to determine the flows of the other two. For example, you may use chemical balances along with either intake air or fuel flow to determine raw exhaust flow. Note that chemical balance calculations allow measured values for the flow rate of diesel exhaust fluid for engines with urea-based selective catalytic reduction.

(b) \* \* \*

(4) The amount of water in a raw or diluted exhaust flow,  $x_{H_2O_{exh}}$ , when you do not measure the amount of water to correct for the amount of water removed by a sampling system. Note that you may not use the water measurement

methods in § 1065.257 to determine  $x_{H_2O_{exh}}$ . Correct for removed water according to § 1065.659.

\* \* \* \* \*

(e) \* \* \*

(1) For liquid fuels, use the default values for  $\alpha$ ,  $\beta$ ,  $\gamma$ , and  $\delta$  in table 2 of this section or determine mass fractions of liquid fuels for calculation of  $\alpha$ ,  $\beta$ ,  $\gamma$ , and  $\delta$  as follows:

(i) Determine the carbon and hydrogen mass fractions according to ASTM D5291 (incorporated by reference, see § 1065.1010). When using ASTM D5291 to determine carbon and hydrogen mass fractions of gasoline (with or without blended ethanol), use good engineering judgment to adapt the method as appropriate. This may include consulting with the instrument manufacturer on how to test high-volatility fuels. Allow the weight of volatile fuel samples to stabilize for 20 minutes before starting the analysis; if the weight still drifts after 20 minutes, prepare a new sample). Retest the sample if the carbon, hydrogen, oxygen, sulfur, and nitrogen mass fractions do not add up to a total mass of  $100 \pm 0.5\%$ ; you may assume oxygen has a zero mass contribution for this specification for diesel fuel and neat (E0) gasoline. You may also assume that sulfur and nitrogen have a zero mass contribution for this specification for all fuels except residual fuel blends.

(ii) Determine oxygen mass fraction of gasoline (with or without blended ethanol) according to ASTM D5599 (incorporated by reference, see § 1065.1010). For all other liquid fuels, determine the oxygen mass fraction using good engineering judgment.

(iii) Determine the nitrogen mass fraction according to ASTM D4629 or ASTM D5762 (incorporated by reference, see § 1065.1010) for all liquid fuels. Select the correct method based on the expected nitrogen content.

(iv) Determine the sulfur mass fraction according to subpart H of this part.

\* \* \* \* \*

(4) Calculate  $\alpha$ ,  $\beta$ ,  $\gamma$ , and  $\delta$  as described in this paragraph (e)(4). If your fuel mixture contains fuels other than carbon-containing fuels, then calculate those fuels' mass fractions  $w_C$ ,  $w_H$ ,  $w_O$ ,  $w_S$ , and  $w_N$  as described in § 1065.656(d). Calculate  $\alpha$ ,  $\beta$ ,  $\gamma$ , and  $\delta$  using the following equations:

$$\alpha = \frac{M_C}{M_H} \cdot \frac{\sum_{j=1}^N \dot{m}_j \cdot w_{Hmeasj}}{\sum_{j=1}^N \dot{m}_j \cdot w_{Cmeasj}}$$

Eq. 1065.655-20

$$\beta = \frac{M_C}{M_O} \cdot \frac{\sum_{j=1}^N \dot{m}_j \cdot w_{Omeasj}}{\sum_{j=1}^N \dot{m}_j \cdot w_{Cmeasj}}$$

Eq. 1065.655-21

$$\gamma = \frac{M_C}{M_S} \cdot \frac{\sum_{j=1}^N \dot{m}_j \cdot w_{Smeasj}}{\sum_{j=1}^N \dot{m}_j \cdot w_{Cmeasj}}$$

Eq. 1065.655-22

$$\delta = \frac{M_C}{M_N} \cdot \frac{\sum_{j=1}^N \dot{m}_j \cdot w_{Nmeasj}}{\sum_{j=1}^N \dot{m}_j \cdot w_{Cmeasj}}$$

Eq. 1065.655-23

Where:

$N$  = total number of fuels and injected fluids over the duty cycle.

$j$  = an indexing variable that represents one fuel or injected fluid, starting with  $j = 1$ .

$\dot{m}_j$  = the mass flow rate of the fuel or any injected fluid  $j$ . For applications using a single fuel and no DEF fluid, set this value to 1. For batch measurements, divide the total mass of fuel over the test interval duration to determine a mass rate.

$w_{Hmeasj}$  = hydrogen mass fraction of fuel or any injected fluid  $j$ .

$w_{Cmeasj}$  = carbon mass fraction of fuel or any injected fluid  $j$ .

$$\dot{n}_{exh} = \frac{1 + x_{H_2O_{exhdry}}}{M_C \cdot x_{C_{combdry}}} \cdot \sum_{j=1}^N \dot{m}_j \cdot w_{Cj}$$

Eq. 1065.655-25

Where:

$\dot{n}_{exh}$  = raw exhaust molar flow rate from which you measured emissions.

$j$  = an indexing variable that represents one fuel or injected fluid, starting with  $j = 1$ .

$N$  = total number of fuels and injected fluids over the duty cycle.

$\dot{m}_j$  = the mass flow rate of the fuel or any injected fluid  $j$ .

$w_{Cj}$  = carbon mass fraction of the fuel and any injected fluid  $j$ , as determined in paragraph (d) of this section.

Example:

$N = 1$

$j = 1$

$w_{Omeasj}$  = oxygen mass fraction of fuel or any injected fluid  $j$ .

$w_{Smeasj}$  = sulfur mass fraction of fuel or any injected fluid  $j$ .

$w_{Nmeasj}$  = nitrogen mass fraction of fuel or any injected fluid  $j$ .

Example:

$N = 1$

$j = 1$

$\dot{m}_1 = 1$

$w_{Hmeas1} = 0.1239$

$w_{Cmeas1} = 0.8206$

$w_{Omeas1} = 0.0547$

$w_{Smeas1} = 0.00066$

$w_{Nmeas1} = 0.000095$

$M_C = 12.0107$  g/mol

$M_H = 1.00794$  g/mol

$M_O = 15.9994$  g/mol

$M_S = 32.065$  g/mol

$M_N = 14.0067$

$$\alpha = \frac{12.0107 \cdot 1 \cdot 0.1239}{1.00794 \cdot 1 \cdot 0.8206}$$

$$\beta = \frac{12.0107 \cdot 1 \cdot 0.0547}{15.9994 \cdot 1 \cdot 0.8206}$$

$$\gamma = \frac{32.065 \cdot 1 \cdot 0.8206}{12.0107 \cdot 1 \cdot 0.00066}$$

$$\delta = \frac{12.0107 \cdot 1 \cdot 0.000095}{14.0067 \cdot 1 \cdot 0.8206}$$

$\alpha = 1.799$

$\beta = 0.05004$

$\gamma = 0.0003012$

$\delta = 0.0001003$

\* \* \* \* \*

(f) \* \* \*

(3) *Fluid mass flow rate calculation.* This calculation may be used only for steady-state laboratory testing. You may not use this calculation if the standard-setting part requires carbon balance error verification as described in § 1065.543. See § 1065.915(d)(5)(iv) for application to field testing. Calculate based on using the following equation:

$\dot{m}_1 = 7.559$  g/s

$w_{C1} = 0.869$  g/g

$M_C = 12.0107$  g/mol

$x_{C_{combdry1}} = 99.87$  mmol/mol = 0.09987 mol/mol

$x_{H_2O_{exhdry1}} = 107.64$  mmol/mol = 0.10764 mol/mol

$$\dot{n}_{\text{exh}} = \frac{1 + 0.10764}{12.0107 \cdot 0.09987} \cdot 7.559 \cdot 0.869$$

$$\dot{n}_{\text{exh}} = 6.066 \text{ mol/s}$$

\* \* \* \* \*

■ 161. Add § 1065.656 to read as follows:

**§ 1065.656 Hydrogen-based chemical balances of fuel, DEF, intake air, and exhaust.**

(a) *General.* Chemical balances of fuel, DEF, intake air, and exhaust may be used to calculate flows, the amount of water in their flows, and the wet concentration of constituents in their flows. See § 1065.520(f) for information about when to use this hydrogen-based chemical balance procedure. With one flow rate of either fuel, intake air, or exhaust, you may use chemical balances to determine the flows of the other two. For example, you may use chemical balances along with either intake air or fuel flow to determine raw exhaust flow. Note that chemical balance calculations allow measured values for the flow rate of diesel exhaust fluid for engines with urea-based selective catalytic reduction.

(b) *Procedures that require chemical balances.* We require chemical balances when you determine the following:

(1) A value proportional to total work, when you choose to determine brake-specific emissions as described in § 1065.650(f).

(2) Raw exhaust molar flow rate either from measured intake air molar flow rate or from fuel mass flow rate as described in paragraph (f) of this section.

(3) Raw exhaust molar flow rate from measured intake air molar flow rate and dilute exhaust molar flow rate as described in paragraph (g) of this section.

(4) The amount of water in a raw or diluted exhaust flow,  $X_{\text{H}_2\text{O}_{\text{exh}}}$ , when you do not measure the amount of water to correct for the amount of water removed by a sampling system. Correct for removed water according to § 1065.659.

(5) The calculated total dilution air flow when you do not measure dilution

air flow to correct for background emissions as described in § 1065.667(c) and (d).

(c) *Chemical balance procedure.* The calculations for a chemical balance involve a system of equations that require iteration. We recommend using a computer to solve this system of equations. You must guess the initial values of two of the following quantities: the amount of hydrogen in the measured flow,  $X_{\text{H}_2\text{exhdry}}$ , the fraction of dilution air in diluted exhaust,  $X_{\text{dil/exhdry}}$ , and the amount of intake air required to produce actual combustion products per mole of dry exhaust,  $X_{\text{int/exhdry}}$ . You may use time-weighted mean values of intake air humidity and dilution air humidity in the chemical balance; as long as your intake air and dilution air humidities remain within tolerances of  $\pm 0.0025$  mol/mol of their respective mean values over the test interval. For each emission concentration,  $x$ , and amount of water,  $X_{\text{H}_2\text{O}_{\text{exh}}}$ , you must determine their completely dry concentrations,  $x_{\text{dry}}$  and  $X_{\text{H}_2\text{O}_{\text{exhdry}}}$ . You must also use your fuel mixture's carbon mass fraction,  $w_{\text{C}}$ , hydrogen mass fraction,  $w_{\text{H}}$ , oxygen mass fraction,  $w_{\text{O}}$ , sulfur mass fraction,  $w_{\text{S}}$ , and nitrogen mass fraction,  $w_{\text{N}}$ ; you may optionally account for diesel exhaust fluid (or other fluids injected into the exhaust), if applicable. Calculate  $w_{\text{C}}$ ,  $w_{\text{H}}$ ,  $w_{\text{O}}$ ,  $w_{\text{S}}$ , and  $w_{\text{N}}$  as described in paragraphs (d) and (e) of this section. You may alternatively use any combination of default values and measured values as described in paragraphs (d) and (e) of this section. Use the following steps to complete a chemical balance:

(1) Convert your measured concentrations such as  $X_{\text{H}_2\text{meas}}$ ,  $X_{\text{NH}_3\text{meas}}$ ,  $X_{\text{CO}_2\text{meas}}$ ,  $X_{\text{COmeas}}$ ,  $X_{\text{THCmeas}}$ ,  $X_{\text{O}_2\text{meas}}$ ,  $X_{\text{H}_2\text{meas}}$ ,  $X_{\text{NOmeas}}$ ,  $X_{\text{NO}_2\text{meas}}$ , and  $X_{\text{H}_2\text{O}_{\text{int}}}$ , to dry concentrations by dividing them by one minus the amount of water present

during their respective measurements; for example:  $X_{\text{H}_2\text{O}_{\text{meas}}}$ ,  $X_{\text{H}_2\text{O}_{\text{xO}_2\text{meas}}}$ ,  $X_{\text{H}_2\text{O}_{\text{xNOmeas}}}$ , and  $X_{\text{H}_2\text{O}_{\text{int}}}$ . If the amount of water present during a "wet" measurement is the same as an unknown amount of water in the exhaust flow,  $X_{\text{H}_2\text{O}_{\text{exh}}}$ , iteratively solve for that value in the system of equations. If you measure only total  $\text{NO}_x$  and not NO and  $\text{NO}_2$  separately, use good engineering judgment to estimate a split in your total  $\text{NO}_x$  concentration between NO and  $\text{NO}_2$  for the chemical balances. For example, if you measure emissions from a stoichiometric combustion engine, you may assume all  $\text{NO}_x$  is NO. For a lean-burn combustion engine, you may assume that your molar concentration of  $\text{NO}_x$ ,  $X_{\text{NO}_x}$ , is 75% NO and 25%  $\text{NO}_2$ . For  $\text{NO}_2$  storage aftertreatment systems, you may assume  $X_{\text{NO}_x}$  is 25% NO and 75%  $\text{NO}_2$ . Note that for calculating the mass of  $\text{NO}_x$  emissions, you must use the molar mass of  $\text{NO}_2$  for the effective molar mass of all  $\text{NO}_x$  species, regardless of the actual  $\text{NO}_2$  fraction of  $\text{NO}_x$ .

(2) Enter the equations in paragraph (c)(5) of this section into a computer program to iteratively solve for  $X_{\text{H}_2\text{exhdry}}$ ,  $X_{\text{dil/exhdry}}$ , and  $X_{\text{int/exhdry}}$ . Use good engineering judgment to guess initial values for  $X_{\text{H}_2\text{exhdry}}$ ,  $X_{\text{dil/exhdry}}$ , and  $X_{\text{int/exhdry}}$ . We recommend guessing an initial amount of hydrogen of 0 mol/mol. We recommend guessing an initial  $X_{\text{int/exhdry}}$  of 1 mol/mol. We also recommend guessing an initial  $X_{\text{dil/exhdry}}$  of 0.8 mol/mol. Iterate values in the system of equations until the most recently updated guesses are all within  $\pm 1\%$  or  $\pm 1$   $\mu\text{mol/mol}$ , whichever is larger, of their respective most recently calculated values.

(3) Use the following symbols and subscripts in the equations for performing the chemical balance calculations in this paragraph (c):

TABLE 1 TO PARAGRAPH (c)(3) OF § 1065.656—SYMBOLS AND SUBSCRIPTS FOR CHEMICAL BALANCE EQUATIONS

$X_{[\text{emission}]_{\text{meas}}}$	Amount of measured emission in the sample at the respective gas analyzer.
$X_{[\text{emission}]_{\text{exh}}}$ .....	Amount of emission per dry mole of exhaust.
$X_{[\text{emission}]_{\text{exhdry}}}$ .....	Amount of emission per dry mole of dry exhaust.
$X_{\text{H}_2\text{O}_{[\text{emission}]_{\text{meas}}}}$ .....	Amount of $\text{H}_2\text{O}$ in sample at emission-detection location; measure or estimate these values according to § 1065.145(e)(2).
$X_{\text{C}_{\text{combdry}}}$ .....	Amount of carbon from fuel and any injected fluids in the exhaust per mole of dry exhaust.
$X_{\text{H}_{\text{combdry}}}$ .....	Amount of hydrogen from fuel and any injected fluids in the exhaust per mole of dry exhaust.
$X_{\text{dil/exh}}$ .....	Amount of dilution gas or excess air per mole of exhaust.
$X_{\text{dil/exhdry}}$ .....	amount of dilution gas and/or excess air per mole of dry exhaust.
$X_{\text{H}_{\text{combdry}}}$ .....	Amount of hydrogen from fuel and any injected fluids in the exhaust per mole of dry exhaust.

TABLE 1 TO PARAGRAPH (c)(3) OF § 1065.656—SYMBOLS AND SUBSCRIPTS FOR CHEMICAL BALANCE EQUATIONS—Continued

$x_{[emission]meas}$	Amount of measured emission in the sample at the respective gas analyzer.
$x_{int/exhdry}$	Amount of intake air required to produce actual combustion products per mole of dry (raw or diluted) exhaust.
$x_{raw/exhdry}$	Amount of undiluted exhaust, without excess air, per mole of dry (raw or diluted) exhaust.
$x_{CO2int}$	Amount of intake air $CO_2$ per mole of intake air.
$x_{CO2intdry}$	amount of intake air $CO_2$ per mole of dry intake air; you may use $x_{CO2intdry} = 375 \mu\text{mol/mol}$ , but we recommend measuring the actual concentration in the intake air.
$x_{H2Oint}$	Amount of $H_2O$ in the intake air, based on a humidity measurement of intake air.
$x_{H2Ointdry}$	Amount of intake air $H_2O$ per mole of dry intake air.
$x_{O2int}$	Amount of intake air $O_2$ per mole of intake air.
$x_{CO2dil}$	Amount of dilution gas $CO_2$ per mole of dilution gas.
$x_{CO2dildry}$	Amount of dilution gas $CO_2$ per mole of dry dilution gas; if you use air as diluent, you may use $x_{CO2dildry} = 375 \mu\text{mol/mol}$ , but we recommend measuring the actual concentration in the dilution gas.
$x_{H2Odil}$	Amount of dilution gas $H_2O$ per mole of dilution gas.
$x_{H2Odildry}$	Amount of dilution gas $H_2O$ per mole of dry dilution gas.
$\tau$	Effective carbon content of the fuel and any injected fluids.
$\chi$	Effective hydrogen content of the fuel and any injected fluids.
$\phi$	Effective oxygen content of the fuel and any injected fluids.
$\xi$	Effective sulfur content of the fuel and any injected fluids.
$\omega$	Effective nitrogen content of the fuel and any injected fluids.
$W_C$	Carbon mass fraction of the fuel (or mixture of test fuels) and any injected fluids.
$W_H$	Hydrogen mass fraction of the fuel (or mixture of test fuels) and any injected fluids.
$W_O$	Oxygen mass fraction of the fuel (or mixture of test fuels) and any injected fluids.
$W_S$	Sulfur mass fraction of the fuel (or mixture of test fuels) and any injected fluids.
$W_N$	Nitrogen mass fraction of the fuel (or mixture of test fuels) and any injected fluids.

(4) Use the equations specified in this section to iteratively solve for  $x_{int/exhdry}$ ,  $x_{dil/exhdry}$ , and  $x_{H2exhdry}$ . The following exceptions apply:

(i) For  $x_{H2exhdry}$  multiple equations are provided, see table 2 to paragraph (c)(6) of this section to determine for which cases the equations apply.

(ii) The calculation of  $x_{O2exhdry}$  is only required when  $x_{O2meas}$  is measured.

(iii) The calculation of  $x_{NH3exhdry}$  is only required for engines that use ammonia as fuel and engines that are subject to  $NH_3$  measurement under the

standard setting part, for all other engines  $x_{NH3exhdry}$  may be set to zero.

(iv) The calculation of  $x_{CO2exhdry}$  is only required for engines that use carbon-containing fuels or fluids, either as single fuel or as part of the fuel mixture, and for engines that are subject to  $CO_2$  measurement under the standard setting part, for all other engines  $x_{CO2exhdry}$  may be set to a value that yields for  $x_{Ccombdry}$  a value of zero. (v) The calculation of  $x_{COexhdry}$  and  $x_{THCexhdry}$  is only required for engines that use carbon-containing fuels and for engines that are subject to CO and THC

measurement under the standard setting part, for all other engines  $x_{COexhdry}$  and  $x_{THCexhdry}$  may be set to zero. (vi) The calculation of  $x_{N2Oexhdry}$  is only required for engines that are subject to  $N_2O$  measurement under the standard setting part, for all other engines  $x_{N2Oexhdry}$  may be set to zero.

(5) The chemical balance equations are as follows:

$$x_{Ccombdry} = x_{co2exhdry} + x_{coexhdry} + x_{THCexhdry} - x_{co2dil} \cdot x_{dil/exhdry} - x_{co2int} \cdot x_{int/exhdry}$$

Eq. 1065.656-1

$$x_{Ccombdry} = x_{CO2exhdry} + x_{COexhdry} + x_{THCexhdry} - x_{CO2dil} \cdot x_{dil/exhdry} - x_{CO2int} \cdot x_{int/exhdry}$$

Eq. 1065.656-2

$$x_{COexhdry} = \frac{x_{COmeas}}{1 - x_{H2OCOmeas}}$$

Eq. 1065.656-3

$$x_{CO2exhdry} = \frac{x_{CO2meas}}{1 - x_{H2OCO2meas}}$$

Eq. 1065.656-4

$$x_{dil/exh} = 1 - \frac{x_{raw/exhdry}}{1 + x_{H2Oexhdry}}$$

Eq. 1065.656-5

$$x_{dil/exhdry} = \frac{x_{dil/exh}}{1 - x_{H2Oexh}}$$

Eq. 1065.656-6 (see table 2 of this section)

$$x_{H2exhdry} = \frac{x_{H2meas}}{1 - x_{H2OH2meas}}$$

Eq. 1065.656-7 (see table 2 of this section)

$$x_{H_2exhdry} = 2 \cdot \left( 1 + x_{H_2Oexhdry} - \frac{1 + x_{H_2Odildry}}{0.209820 - x_{CO_2dildry}} \cdot x_{O_2exhdry} - x_{int/exhdry} - x_{THCexhdry} \right) + x_{NO_2exhdry} + x_{N_2Oexhdry} - x_{COexhdry} - \frac{1}{2} \cdot (x_{Hcombdry} + x_{NH_3exhdry}) - \left( \frac{w_O}{M_O} + \frac{w_N}{M_N} \right) \cdot \frac{x_{Ccombdry} \cdot M_C + x_{Hcombdry} \cdot M_H}{w_C + w_H}$$

Eq. 1065.656-8

Eq. 1065.656-9

Eq. 1065.656-10

$$x_{H_2Oexh} = \frac{x_{H_2Oexhdry}}{1 + x_{H_2Oexhdry}}$$

$$x_{H_2Oexhdry} = \frac{x_{H_2Omeas}}{1 - x_{H_2Omeas}}$$

$$x_{Hcombdry} = 2 \cdot x_{H_2Oexhdry} + 2 \cdot x_{H_2exhdry} + 3 \cdot x_{NH_3exhdry} - 2 \cdot x_{H_2Odil} \cdot x_{dil/exhdry} - 2 \cdot x_{H_2Oint} \cdot x_{int/exhdry}$$

Eq. 1065.656-11

$$x_{int/exhdry} = \frac{1}{2 \cdot x_{O_2int}} \cdot \left( \begin{aligned} &\frac{1}{2} \cdot (x_{Hcombdry} - 2 \cdot x_{H_2exhdry} - 3 \cdot x_{NH_3exhdry}) \\ &+ 2 \cdot \left( x_{Ccombdry} - \frac{1}{2} \cdot x_{COexhdry} - x_{THCexhdry} \right) \\ &+ \left( 2 \cdot \frac{w_S}{M_S} - \frac{w_O}{M_O} \right) \cdot \frac{x_{Ccombdry} \cdot M_C + x_{Hcombdry} \cdot M_H}{w_C + w_H} \\ &+ 2 \cdot x_{NO_2exhdry} + x_{NOexhdry} + x_{N_2Oexhdry} \end{aligned} \right)$$

Eq. 1065.656-12

$$x_{NOexhdry} = \frac{x_{NOmeas}}{1 - x_{H_2ONOmeas}}$$

Eq. 1065.656-15

$$x_{NH_3exhdry} = \frac{x_{NH_3meas}}{1 - x_{H_2ONH_3meas}}$$

Eq. 1065.656-14

$$x_{O_2exhdry} = \frac{x_{O_2meas}}{1 - x_{H_2OO_2meas}}$$

Eq. 1065.656-13

$$x_{NO_2exhdry} = \frac{x_{NO_2meas}}{1 - x_{H_2ONO_2meas}}$$

Eq. 1065.656-16 (see table 2 of this section)

$$x_{raw/exhdry} = \frac{1}{2} \cdot x_{COexhdry} + x_{THCexhdry} + \frac{1}{4} \cdot x_{Hcombdry} + \frac{1}{2} \cdot x_{H_2exhdry} + \frac{1}{4} \cdot x_{NH_3exhdry} + \frac{1}{2} \cdot \left( \frac{w_O}{M_O} + \frac{w_N}{M_N} \right) \cdot \frac{x_{Ccombdry} \cdot M_C + x_{Hcombdry} \cdot M_H}{w_C + w_H} - \frac{1}{2} \cdot x_{NO_2exhdry} - \frac{1}{2} \cdot x_{N_2Oexhdry} + x_{int/exhdry}$$

Eq. 1065.656-17

$$x_{THCdry} = \frac{x_{THCmeas}}{1 - x_{H_2OTHCmeas}}$$

$$x_{CO_2intdry} = \frac{x_{CO_2int}}{1 - x_{H_2Oint}}$$

Eq. 1065.656-19

$$x_{O_2int} = \frac{0.209820 - x_{CO_2intdry}}{1 + x_{H_2Ointdry}}$$

Eq. 1065.656-21

Eq. 1065.656-18

$$x_{H_2Ointdry} = \frac{x_{H_2Oint}}{1 - x_{H_2Oint}}$$

Eq. 1065.656-20

$$x_{CO_2dildry} = \frac{x_{CO_2dil}}{1 - x_{H_2Odil}}$$



Eq. 1065.656-22

$$x_{\text{H}_2\text{O}}^{\text{dil/dry}} = \frac{x_{\text{H}_2\text{O}}^{\text{dil}}}{1 - x_{\text{H}_2\text{O}}^{\text{dil}}}$$

Eq. 1065.656-23

(6) Depending on your measurements, use the equations and guess the

quantities specified in the following table:

TABLE 2 TO PARAGRAPH (c)(6) OF § 1065.656—CHEMICAL BALANCE EQUATIONS FOR DIFFERENT MEASUREMENTS

When measuring	Guess . . .	Calculate . . .
(i) $x_{\text{O}_2}^{\text{meas}}$ .....	$x_{\text{int/exhdry}}$ and $x_{\text{H}_2}^{\text{exhdry}}$ .....	(A) $x_{\text{H}_2}^{\text{exhdry}}$ using Eq. 1065.656-7. (B) $x_{\text{O}_2}^{\text{exhdry}}$ using Eq. 1065.656-16.
(ii) $x_{\text{H}_2}^{\text{meas}}$ .....	$x_{\text{int/exhdry}}$ and $x_{\text{dil/exhdry}}$ .....	(A) $x_{\text{H}_2}^{\text{exhdry}}$ using Eq. 1065.656-6. (B) [Reserved].

(7) The following example is a solution for  $x_{\text{int/exhdry}}$ ,  $x_{\text{dil/exhdry}}$ , and

$x_{\text{H}_2\text{O}}^{\text{exhdry}}$  using the equations in paragraph (c)(5) of this section:

$$x_{Ccombdry} = 0.00634752 + 0.000303075 + 0.000187618 - 0.000368652 \cdot 0.280097 - 0.000368652 \cdot 0.758282 = 0.00645541 \text{ mol/mol}$$

$$x_{COexhdry} = \frac{0.000231}{1 - 0.237813} = 0.000303075 \text{ mol/mol}$$

$$x_{CO2exhdry} = \frac{0.004838}{1 - 0.237813} = 0.00634752 \text{ mol/mol}$$

$$x_{dil/exh} = 1 - \frac{1.03192}{1 + 0.312013} = 0.213487 \text{ mol/mol}$$

$$x_{dil/exhdry} = \frac{0.213487}{1 - 0.237813} = 0.280097 \text{ mol/mol}$$

$$x_{H2exhdry} = \frac{0.003757}{1 - 0.237813} = 0.00492923 \text{ mol/mol}$$

$$x_{H2exhdry} = 2 \cdot \left( 1 + 0.312013 - \frac{1 + 0.0172199}{0.209820 - 0.000375} \cdot 0.0576719 - 0.758282 - 0.000187618 \right) + 0.000000472325 + 0.0000314883 - 0.000303075 - \frac{1}{2} \cdot (0.641384 + 0.014218289) - \left( \frac{0.00121459}{15.9994} + \frac{0.804173}{14.0067} \right) \cdot \frac{0.00645541 \cdot 12.0107 + 0.641384 \cdot 1.00794}{0.0182358 + 0.176362} = 0.00492923 \text{ mol/mol}$$

$$x_{H2Oexh} = \frac{0.312013}{1 + 0.312013} = 0.237813 \text{ mol/mol}$$

$$x_{H2Oexhdry} = \frac{0.237813}{1 - 0.237813} = 0.312013 \text{ mol/mol}$$

$$x_{Hcombdry} = 2 \cdot 0.312013 + 2 \cdot 0.00492923 + 3 \cdot 0.014218289 - 2 \cdot 0.0169284 \cdot 0.280097 - 2 \cdot 0.0169284 \cdot 0.758282 = 0.641384 \text{ mol/mol}$$

$$x_{int/exhdry} = \frac{1}{2 \cdot 0.205899} \cdot \left( \frac{1}{2} \cdot (0.641384 - 2 \cdot 0.00492923 - 3 \cdot 0.014218289) + 2 \cdot \left( 0.00645541 - \frac{1}{2} \cdot 0.000303075 - 0.000187618 \right) + \left( 2 \cdot \frac{0.0000146052}{32.065} - \frac{0.00121459}{15.9994} \right) \cdot \frac{0.00645541 \cdot 12.0107 + 0.641384 \cdot 1.00794}{0.0182358 + 0.176362} + 2 \cdot 0.000000472325 + 0.00583846 + 0.0000314883 \right) = 0.758282 \text{ mol/mol}$$

$$x_{NH3exhdry} = \frac{0.010837}{1 - 0.237813} = 0.014218289 \text{ mol/mol}$$

$$x_{NOexhdry} = \frac{0.004450}{1 - 0.237813} = 0.00583846 \text{ mol/mol}$$

$$x_{NO2exhdry} = \frac{0.00000036}{1 - 0.237813} = 0.000000472325 \text{ mol/mol}$$

$$x_{N2Oexhdry} = \frac{0.000024}{1 - 0.237813} = 0.0000314883 \text{ mol/mol}$$

$$x_{O_2exhdry} = \frac{0.0439568}{1 - 0.237813} = 0.0576719 \text{ mol/mol}$$

$$x_{raw/exhdry} = \frac{1}{2} \cdot 0.000303075 + 0.000187618 + \frac{0.641384}{4} + \frac{0.00492923}{2} + \frac{0.014218289}{4}$$

$$+ \frac{1}{2} \cdot \left( \frac{0.00121459}{15.9994} + \frac{0.804173}{14.0067} \right) \cdot \frac{0.00645541 \cdot 12.0107 + 0.641384 \cdot 1.00794}{0.0182358 + 0.176362}$$

$$- \frac{1}{2} \cdot 0.000000472325 - \frac{1}{2} \cdot 0.0000314883 + 0.758282 = 1.03192 \text{ mol/mol}$$

$$x_{IHCdry} = \frac{0.000143}{1 - 0.237813} = 0.000187618 \text{ mol/mol}$$

$$x_{CO_2intdry} = \frac{0.000368652}{1 - 0.0169284} = 0.000375 \text{ mol/mol}$$

$$x_{H_2Ointdry} = \frac{0.0169284}{1 - 0.0169284} = 0.0172199 \text{ mol/mol}$$

$$x_{O_2int} = \frac{0.209820 - 0.000375}{1 + 0.0172199} = 0.205899 \text{ mol/mol}$$

$$x_{CO_2dildry} = \frac{0.000368652}{1 - 0.0169284} = 0.000375 \text{ mol/mol}$$

$$x_{H_2Odildry} = \frac{0.0169284}{1 - 0.0169284} = 0.0172199 \text{ mol/mol}$$

(d) *Mass fractions of fuel.* (1) For fuels other than carbon-containing fuels determine the mass fractions of fuel  $W_C$ ,  $W_H$ ,  $W_O$ ,  $W_S$ , and  $W_N$ , based on the fuel properties as determined in paragraph (e) of this section. Calculate  $W_C$ ,  $W_H$ ,  $W_O$ ,  $W_S$ , and  $W_N$  using the following equations:

$$W_C = \frac{\tau \cdot M_C}{\tau \cdot M_C + \chi \cdot M_H + \varphi \cdot M_O + \xi \cdot M_S + \omega \cdot M_N}$$

Eq. 1065.656-24

$$W_H = \frac{\chi \cdot M_H}{\tau \cdot M_C + \chi \cdot M_H + \varphi \cdot M_O + \xi \cdot M_S + \omega \cdot M_N}$$

Eq. 1065.656-25

$$W_O = \frac{\varphi \cdot M_O}{\tau \cdot M_C + \chi \cdot M_H + \varphi \cdot M_O + \xi \cdot M_S + \omega \cdot M_N}$$

Eq. 1065.656-26

$$W_S = \frac{\xi \cdot M_S}{\tau \cdot M_C + \chi \cdot M_H + \varphi \cdot M_O + \xi \cdot M_S + \omega \cdot M_N}$$

Eq. 1065.656-27

$$W_N = \frac{\omega \cdot M_N}{\tau \cdot M_C + \chi \cdot M_H + \varphi \cdot M_O + \xi \cdot M_S + \omega \cdot M_N}$$

Eq. 1065.656–28

Where:

$w_C$  = carbon mass fraction of the fuel and any injected fluids.

$w_H$  = hydrogen mass fraction of the fuel and any injected fluids.

$w_O$  = oxygen mass fraction of the fuel and any injected fluids.

$w_S$  = sulfur mass fraction of the fuel and any injected fluids.

$w_N$  = nitrogen mass fraction of the fuel and any injected fluids.

$\tau$  = effective carbon content of the fuel and any injected fluids.

$M_C$  = molar mass of carbon.

$\chi$  = effective hydrogen content of the fuel and any injected fluids.

$M_H$  = molar mass of hydrogen.

$\phi$  = effective oxygen content of the fuel and any injected fluids.

$M_O$  = molar mass of oxygen.

$\xi$  = effective sulfur content of the fuel and any injected fluids.

$M_S$  = molar mass of nitrogen.

$\omega$  = effective nitrogen content of the fuel and any injected fluids.

$M_N$  = molar mass of nitrogen.

*Example for NH<sub>3</sub> fuel:*

$\tau = 0$

$\chi = 3$

$\phi = 0$

$\xi = 0$

$\omega = 1$

$M_C = 12.0107$  g/mol

$M_H = 1.00794$  g/mol

$M_O = 15.9994$  g/mol

$M_S = 32.065$  g/mol

$M_N = 14.0067$  g/mol

$$w_C = \frac{0 \cdot 12.0107}{0 \cdot 12.0107 + 3 \cdot 1.00794 + 0 \cdot 15.9994 + 0 \cdot 32.065 + 1 \cdot 14.0067}$$

$$w_H = \frac{3 \cdot 1.00794}{0 \cdot 12.0107 + 3 \cdot 1.00794 + 0 \cdot 15.9994 + 0 \cdot 32.065 + 1 \cdot 14.0067}$$

$$w_O = \frac{0 \cdot 15.9994}{0 \cdot 12.0107 + 3 \cdot 1.00794 + 0 \cdot 15.9994 + 0 \cdot 32.065 + 1 \cdot 14.0067}$$

$$w_S = \frac{0 \cdot 32.065}{0 \cdot 12.0107 + 3 \cdot 1.00794 + 0 \cdot 15.9994 + 0 \cdot 32.065 + 1 \cdot 14.0067}$$

$$w_N = \frac{1 \cdot 14.0067}{0 \cdot 12.0107 + 3 \cdot 1.00794 + 0 \cdot 15.9994 + 0 \cdot 32.065 + 1 \cdot 14.0067}$$

$w_C = 0$  g/g

$w_H = 0.1775530$  g/g

$w_O = 0$  g/g

$w_S = 0$  g/g

$w_N = 0.8224470$  g/g

(2) For carbon-containing fuels and diesel exhaust fluid determine the mass fractions of fuel,  $W_C$ ,  $W_H$ ,  $W_O$ ,  $W_S$ , and

$W_N$ , based on properties determined according to § 1065.655(d). Calculate  $W_C$ ,  $W_H$ ,  $W_O$ ,  $W_S$ , and  $W_N$  using the following equations:

$$W_C = \frac{1 \cdot M_C}{1 \cdot M_C + \alpha \cdot M_H + \beta \cdot M_O + \gamma \cdot M_S + \delta \cdot M_N}$$

Eq. 1065.656–29

$$W_H = \frac{\alpha \cdot M_H}{1 \cdot M_C + \alpha \cdot M_H + \beta \cdot M_O + \gamma \cdot M_S + \delta \cdot M_N}$$

Eq. 1065.656–30

$$W_O = \frac{\beta \cdot M_O}{1 \cdot M_C + \alpha \cdot M_H + \beta \cdot M_O + \gamma \cdot M_S + \delta \cdot M_N}$$

Eq. 1065.656–31

$$W_S = \frac{\gamma \cdot M_S}{1 \cdot M_C + \alpha \cdot M_H + \beta \cdot M_O + \gamma \cdot M_S + \delta \cdot M_N}$$

Eq. 1065.656-32

$$w_N = \frac{\delta \cdot M_N}{1 \cdot M_C + \alpha \cdot M_H + \beta \cdot M_O + \gamma \cdot M_S + \delta \cdot M_N}$$

Eq. 1065.656-33

Where:

$w_C$  = carbon mass fraction of the fuel and any injected fluids.  
 $w_H$  = hydrogen mass fraction of the fuel and any injected fluids.  
 $w_O$  = oxygen mass fraction of the fuel and any injected fluids.  
 $w_S$  = sulfur mass fraction of the fuel and any injected fluids.  
 $w_N$  = nitrogen mass fraction of the fuel and any injected fluids.

$M_C$  = molar mass of carbon.  
 $\alpha$  = atomic hydrogen-to-carbon ratio of the fuel and any injected fluids.  
 $M_H$  = molar mass of hydrogen.  
 $\beta$  = atomic oxygen-to-carbon ratio of the fuel and any injected fluids.  
 $M_O$  = molar mass of oxygen.  
 $\gamma$  = atomic sulfur-to-carbon ratio of the fuel and any injected fluids.  
 $M_S$  = molar mass of sulfur.  
 $\delta$  = atomic nitrogen-to-carbon ratio of the fuel and any injected fluids.

$M_N$  = molar mass of nitrogen.

Example:

$\alpha = 1.8$   
 $\beta = 0.05$   
 $\gamma = 0.0003$   
 $\delta = 0.0001$   
 $M_C = 12.0107$   
 $M_H = 1.00794$   
 $M_O = 15.9994$   
 $M_S = 32.065$   
 $M_N = 14.0067$

$$w_C = \frac{1 \cdot 12.0107}{1 \cdot 12.0107 + 1.8 \cdot 1.00794 + 0.05 \cdot 15.9994 + 0.0003 \cdot 32.065 + 0.0001 \cdot 14.0067}$$

$w_C = 0.820628$

$$w_H = \frac{1.8 \cdot 1.00794}{1 \cdot 12.0107 + 1.8 \cdot 1.00794 + 0.05 \cdot 15.9994 + 0.0003 \cdot 32.065 + 0.0001 \cdot 14.0067}$$

$w_H = 0.123961$

$$w_O = \frac{0.05 \cdot 15.9994}{1 \cdot 12.0107 + 1.8 \cdot 1.00794 + 0.05 \cdot 15.9994 + 0.0003 \cdot 32.065 + 0.0001 \cdot 14.0067}$$

$w_O = 0.0546578$

$$w_S = \frac{0.0003 \cdot 32.065}{1 \cdot 12.0107 + 1.8 \cdot 1.00794 + 0.05 \cdot 15.9994 + 0.0003 \cdot 32.065 + 0.0001 \cdot 14.0067}$$

$w_S = 0.000657250$

$$w_N = \frac{0.0001 \cdot 14.0067}{1 \cdot 12.0107 + 1.8 \cdot 1.00794 + 0.05 \cdot 15.9994 + 0.0003 \cdot 32.065 + 0.0001 \cdot 14.0067}$$

$w_N = 0.0000957004$

(3) For nonconstant fuel mixtures, you must account for the varying proportions of the different fuels. This paragraph (d)(3) generally applies for dual-fuel and flexible-fuel engines, but optionally it may also be applied if diesel exhaust fluid or other fluids injected into the exhaust are injected in a way that is not strictly proportional to fuel flow. Account for these varying concentrations either with a batch measurement that provides averaged values to represent the test interval, or by analyzing data from continuous mass rate measurements. Application of average values from a batch measurement generally applies to situations where one fluid is a minor component of the total fuel mixture; consistent with good engineering

judgment. Calculate  $w_C$ ,  $w_H$ ,  $w_O$ ,  $w_S$ , and  $w_N$  of the fuel mixture using the following equations:

$$w_C = \frac{\sum_{j=1}^N \dot{m}_j \cdot w_{Cmeasj}}{\sum_{j=1}^N \dot{m}_j}$$

Eq. 1065.656-34

$$w_H = \frac{\sum_{j=1}^N \dot{m}_j \cdot w_{Hmeasj}}{\sum_{j=1}^N \dot{m}_j}$$

Eq. 1065.656-35

$$w_O = \frac{\sum_{j=1}^N \dot{m}_j \cdot w_{Omeasj}}{\sum_{j=1}^N \dot{m}_j}$$

Eq. 1065.656-36

$$w_S = \frac{\sum_{j=1}^N \dot{m}_j \cdot w_{Smeasj}}{\sum_{j=1}^N \dot{m}_j}$$

Eq. 1065.656-37

$$w_N = \frac{\sum_{j=1}^N \dot{m}_j \cdot w_{Nmeasj}}{\sum_{j=1}^N \dot{m}_j}$$

Eq. 1065.656-38

Where:

$w_C$  = carbon mass fraction of the mixture of test fuels and any injected fluids.  
 $w_H$  = hydrogen mass fraction of the mixture of test fuels and any injected fluids.  
 $w_O$  = oxygen mass fraction of the mixture of test fuels and any injected fluids.  
 $w_S$  = sulfur mass fraction of the mixture of test fuels and any injected fluids.

$w_N$  = nitrogen mass fraction of the mixture of test fuels and any injected fluids.  
 $N$  = total number of fuels and injected fluids over the duty cycle.  
 $j$  = an indexing variable that represents one fuel or injected fluid, starting with  $j = 1$ .  
 $\dot{m}_j$  = the mass flow rate of the fuel or any injected fluid  $j$ . For batch measurements, divide the total mass of fuel over the test interval duration to determine a mass rate.  
 $w_{Cmeasj}$  = carbon mass fraction of fuel or any injected fluid  $j$ .

$w_{Hmeasj}$  = hydrogen mass fraction of fuel or any injected fluid  $j$ .  
 $w_{Omeasj}$  = oxygen mass fraction of fuel or any injected fluid  $j$ .  
 $w_{Smeasj}$  = sulfur mass fraction of fuel or any injected fluid  $j$ .  
 $w_{Nmeasj}$  = nitrogen mass fraction of fuel or any injected fluid  $j$ .  
*Example for a mixture of diesel and NH<sub>3</sub> fuel where diesel represents 15% of energy:*  
 $N = 2$

$\dot{m}_1 = 0.5352$  g/s  
 $\dot{m}_2 = 7.024$  g/s  
 $w_{Cmeas1} = 0.820628$  g/g  
 $w_{Hmeas1} = 0.123961$  g/g  
 $w_{Omeas1} = 0.0546578$  g/g  
 $w_{Smeas1} = 0.00065725$  g/g  
 $w_{Nmeas1} = 0.0000957004$  g/g  
 $w_{Cmeas2} = 0$  g/g  
 $w_{Hmeas2} = 0.177553$  g/g  
 $w_{Omeas2} = 0$  g/g  
 $w_{Smeas2} = 0$  g/g  
 $w_{Nmeas2} = 0.822447$  g/g

$$w_C = \frac{0.5352 \cdot 0.820628 + 7.024 \cdot 0}{0.5352 + 7.024}$$

$$w_H = \frac{0.5352 \cdot 0.123961 + 7.024 \cdot 0.177553}{0.5352 + 7.024}$$

$$w_O = \frac{0.5352 \cdot 0.0546578 + 7.024 \cdot 0}{0.5352 + 7.024}$$

$$w_S = \frac{0.5352 \cdot 0.00065725 + 7.024 \cdot 0}{0.5352 + 7.024}$$

$$w_N = \frac{0.5352 \cdot 0.0000957004 + 7.024 \cdot 0.822447}{0.5352 + 7.024}$$

$w_C = 0.0581014$  g/g  
 $w_H = 0.1737586$  g/g  
 $w_O = 0.00386983$  g/g  
 $w_S = 0.0000465341$  g/g  
 $w_N = 0.76422359$  g/g

(e) *Fuel and diesel exhaust fluid composition.* (1) For carbon-containing fuels and diesel exhaust fluid determine the composition represented by  $\alpha$ ,  $\beta$ ,  $\gamma$ , and  $\delta$ , as described in § 1065.655(e).

(2) For fuels other than carbon-containing fuels use the default values for  $\tau$ ,  $\chi$ ,  $\phi$ ,  $\xi$ , and  $\omega$  in table 3 to this section, or use good engineering judgment to determine those values based on measurement. If you determine compositions based on measured values and the default value listed in table 3 to this section is zero, you may set  $\tau$ ,  $\phi$ ,  $\xi$ , and  $\omega$  to zero; otherwise determine  $\tau$ ,  $\phi$ ,

$\xi$ , and  $\omega$  (along with  $\chi$ ) based on measured values.

(3) If your fuel mixture contains carbon-containing fuels and your testing requires fuel composition values referencing carbon, calculate  $\alpha$ ,  $\beta$ ,  $\gamma$ , and  $\delta$  for the fuel mixture as described in § 1065.655(e)(4).

(4) Table 3 to this paragraph (e)(4) follows:

TABLE 3 TO PARAGRAPH (e)(4) OF § 1065.656—DEFAULT VALUES OF  $\tau$ ,  $\chi$ ,  $\phi$ ,  $\xi$ , AND  $\omega$

Fuel	Atomic carbon, oxygen, and nitrogen-to-hydrogen ratios C <sub>τ</sub> H <sub>≤χ</sub> O <sub>φ</sub> S <sub>ξ</sub> N <sub>ω</sub>
Hydrogen .....	C <sub>0</sub> H <sub>2</sub> O <sub>0</sub> S <sub>0</sub> N <sub>0</sub> .
Ammonia .....	C <sub>0</sub> H <sub>3</sub> O <sub>0</sub> S <sub>0</sub> N <sub>1</sub> .

(f) *Calculated raw exhaust molar flow rate from measured intake air molar flow rate or fuel mass flow rate.* You may calculate the raw exhaust molar flow rate from which you sampled emissions,  $\dot{m}_e$ , based on the measured intake air molar flow rate,  $\dot{m}_a$ , or the measured fuel mass flow rate,  $\dot{m}_f$ , and the values calculated using the chemical balance in paragraph (c) of this section. The chemical balance must be based on raw exhaust gas concentrations. Solve for the chemical balance in paragraph

(c) of this section at the same frequency that you update and record or . For laboratory tests, calculating raw exhaust molar flow rate using measured fuel mass flow rate is valid only for steady-state testing. See § 1065.915(d)(5)(iv) for application to field testing.

(1) *Crankcase flow rate.* If engines are not subject to crankcase controls under the standard-setting part, you may calculate raw exhaust flow based on or using one of the following:

(i) You may measure flow rate through the crankcase vent and subtract it from the calculated exhaust flow.

(ii) You may estimate flow rate through the crankcase vent by engineering analysis as long as the uncertainty in your calculation does not adversely affect your ability to show that your engines comply with applicable emission standards.

(iii) You may assume your crankcase vent flow rate is zero.

(2) Intake air molar flow rate calculation. Calculate  $\dot{n}$  based on using the following equation:

$$\dot{n}_{\text{exh}} = \frac{\dot{n}_{\text{int}}}{\left(1 + \frac{(x_{\text{int/exhdry}} - x_{\text{raw/exhdry}})}{(1 + x_{\text{H2Oexhdry}})}\right)}$$

Eq. 1065.656-39

Where:

$\dot{n}_{\text{exh}}$  = raw exhaust molar flow rate from which you measured emissions.  
 $\dot{n}_{\text{int}}$  = intake air molar flow rate including humidity in intake air.

Example:

$$\dot{n}_{\text{exh}} = \frac{3.780}{\left(1 + \frac{(0.69021 - 1.10764)}{(1 + 0.10764)}\right)}$$

$$\dot{n}_{\text{exh}} = 6.066 \text{ mol/s}$$

$\dot{n}_{\text{int}} = 3.780 \text{ mol/s}$

$x_{\text{int/exhdry}} = 0.69021 \text{ mol/mol}$

$x_{\text{raw/exhdry}} = 1.10764 \text{ mol/mol}$

$x_{\text{H2Oexhdry}} = 107.64 \text{ mmol/mol} = 0.10764 \text{ mol/mol}$

(3) Fluid mass flow rate calculation. This calculation may be used only for

steady-state laboratory testing. See § 1065.915(d)(5)(iv) for application to

field testing. Calculate based on using the following equation:

$$\dot{n}_{\text{exh}} = \frac{1 + x_{\text{H2Oexhdry}}}{M_{\text{C}} \cdot x_{\text{Ccombdry}} + M_{\text{H}} \cdot x_{\text{Hcombdry}}} \cdot \sum_{j=1}^N \dot{m}_j \cdot (w_{\text{C}j} + w_{\text{H}j})$$

Eq. 1065.656-40

Where:

$\dot{n}_{\text{exh}}$  = raw exhaust molar flow rate from which you measured emissions.

$j$  = an indexing variable that represents one fuel or injected fluid, starting with  $j = 1$ .  
 $N$  = total number of fuels and injected fluids over the duty cycle.

$\dot{m}_j$  = the mass flow rate of the fuel or any injected fluid  $j$ .

$w_{\text{C}j}$  = carbon mass fraction of the fuel (or mixture of test fuels) and any injected fluid  $j$ .

$w_{\text{H}j}$  = hydrogen mass fraction of the fuel (or mixture of test fuels) and any injected fluid  $j$ .

Example:

$x_{\text{H2Oexhdry1}} = 312.013 \text{ mmol/mol} = 0.10764 \text{ mol/mol}$

$M_{\text{C}} = 12.0107 \text{ g/mol}$

$M_{\text{H}} = 1.00794 \text{ g/mol}$

$x_{\text{Ccombdry1}} = 6.45541 \text{ mmol/mol} = 0.00645541 \text{ mol/mol}$

$x_{\text{Hcombdry1}} = 641.384 \text{ mmol/mol} = 0.641384 \text{ mol/mol}$

$\dot{m}_1 = 0.167974 \text{ g/s}$

$\dot{m}_2 = 7.39103 \text{ g/s}$

$w_{\text{C}1} = 0.820628 \text{ g/g}$

$w_{\text{C}2} = 0 \text{ g/g}$

$w_{\text{H}1} = 0.123961 \text{ g/g}$

$w_{\text{H}2} = 0.177553 \text{ g/g}$

$N = 2$

$$\dot{n}_{\text{exh}} = \frac{1 + 0.312013}{12.0107 \cdot 0.00645541 + 1.00794 \cdot 0.641384 \cdot (0.167974 \cdot (0.820628 + 0.123961) + 7.39103 \cdot (0 + 0.177553))}$$

$$\dot{n}_{\text{exh}} = 2.66561 \text{ mol/s}$$

(g) Calculated raw exhaust molar flow rate from measured intake air molar flow rate, dilute exhaust molar flow rate, and dilute chemical balance. You may calculate the raw exhaust molar flow rate,  $\dot{n}_{\text{exh}}$ , based on the measured intake air molar flow rate,  $\dot{n}_{\text{int}}$ , the measured dilute exhaust molar flow rate,  $\dot{n}_{\text{dexh}}$ , and the values calculated using the chemical balance in paragraph (c) of this section. Note that the chemical balance must be based on dilute exhaust gas concentrations. For continuous-flow calculations, solve for the chemical balance in paragraph (c) of this section at the same frequency that you update and record  $\dot{n}_{\text{int}}$  and  $\dot{n}_{\text{dexh}}$ . This calculated  $\dot{n}_{\text{dexh}}$  may be used for the PM dilution ratio verification in § 1065.546; the calculation of dilution air molar flow rate in the background

correction in § 1065.667; and the calculation of mass of emissions in § 1065.650(c) for species that are measured in the raw exhaust.

(1) Crankcase flow rate. If engines are not subject to crankcase controls under the standard-setting part, calculate raw exhaust flow as described in paragraph (f)(1) of this section.

(2) Dilute exhaust and intake air molar flow rate calculation. Calculate as follows:

$$\dot{n}_{\text{exh}} = (x_{\text{raw/exhdry}} - x_{\text{int/exhdry}}) \cdot (1 - x_{\text{H2Oexh}}) \cdot \dot{n}_{\text{dexh}} + \dot{n}_{\text{int}}$$

Eq. 1065.656-41

Example:

$\dot{n}_{\text{int}} = 7.930 \text{ mol/s}$

$x_{\text{raw/exhdry}} = 0.1544 \text{ mol/mol}$

$x_{\text{int/exhdry}} = 0.1451 \text{ mol/mol}$

$x_{\text{H2Oexhdry}} = 32.46 \text{ mmol/mol} = 0.03246 \text{ mol/mol}$

$\dot{n}_{\text{dexh}} = 49.02 \text{ mol/s}$

$\dot{n}_{\text{exh}} = (0.1544 - 0.1451) \cdot (1 - 0.03246) \cdot 49.02 + 7.930 = 0.4411 + 7.930 = 8.371 \text{ mol/s}$

■ 162. Revise and republish § 1065.660 to read as follows:

**§ 1065.660 THC, NMHC, NMNEHC, CH<sub>4</sub>, and C<sub>2</sub>H<sub>6</sub> determination.**

(a) THC determination and initial THC/CH<sub>4</sub> contamination corrections. (1) If we require you to determine THC emissions, calculate  $\chi_{\text{THC}[\text{THC-FID}]_{\text{cor}}}$  using the initial THC contamination concentration  $\chi_{\text{THC}[\text{THC-FID}]_{\text{init}}}$  from § 1065.520 as follows:

$$\chi_{\text{THC}[\text{THC-FID}]_{\text{cor}}} = \chi_{\text{THC}[\text{THC-FID}]_{\text{uncor}}} - \chi_{\text{THC}[\text{THC-FID}]_{\text{init}}}$$

Eq. 1065.660-1

Example:

$\chi_{\text{THCuncor}} = 150.3 \text{ } \mu\text{mol/mol}$

$\chi_{\text{THCinit}} = 1.1 \mu\text{mol/mol}$   
 $\chi_{\text{THCcor}} = 150.3 - 1.1$   
 $\chi_{\text{THCcor}} = 149.2 \mu\text{mol/mol}$

(2) For the NMHC determination described in paragraph (b) of this section, correct  $\chi_{\text{THC}[\text{THC-FID}]}$  for initial THC contamination using Eq. 1065.660-1. You may correct  $\chi_{\text{THC}[\text{NMC-FID}]}$  for initial contamination of the CH<sub>4</sub> sample train using Eq. 1065.660-1, substituting in CH<sub>4</sub> concentrations for THC.

(3) For the NMNEHC determination described in paragraph (c) of this section, correct  $\chi_{\text{THC}[\text{THC-FID}]}$  for initial THC contamination using Eq. 1065.660-1. You may correct  $\chi_{\text{THC}[\text{NMC-FID}]}$  for initial contamination of the CH<sub>4</sub> sample train using Eq. 1065.660-1, substituting in CH<sub>4</sub> concentrations for THC.

(4) For the CH<sub>4</sub> determination described in paragraph (d) of this section, you may correct  $\chi_{\text{THC}[\text{NMC-FID}]}$  for initial THC contamination of the CH<sub>4</sub>

sample train using Eq. 1065.660-1, substituting in CH<sub>4</sub> concentrations for THC.

(5) You may calculate THC as the sum of NMHC and CH<sub>4</sub> if you determine CH<sub>4</sub> with an FTIR as described in paragraph (d)(2) of this section and NMHC with an FTIR using the additive method from paragraph (b)(4) of this section.

(6) You may calculate THC as the sum of NMNEHC, C<sub>2</sub>H<sub>6</sub>, and CH<sub>4</sub> if you determine CH<sub>4</sub> with an FTIR as described in paragraph (d)(2) of this section, C<sub>2</sub>H<sub>6</sub> with an FTIR as described in paragraph (e) of this section, and NMNEHC with an FTIR using the additive method from paragraph (c)(3) of this section.

(b) *NMHC determination.* Use one of the following to determine NMHC concentration,  $\chi_{\text{NMHC}}$ :

(1) If you do not measure CH<sub>4</sub>, you may omit the calculation of NMHC

concentrations and calculate the mass of NMHC as described in § 1065.650(c)(5).

(2) For an NMC, calculate  $\chi_{\text{NMHC}}$  using the NMC's penetration fractions, response factors, and/or combined penetration fractions and response factors as described in § 1065.365, the THC FID's CH<sub>4</sub> response factor,  $RF_{\text{CH}_4[\text{THC-FID}]}$ , from § 1065.360, the initial THC contamination and dry-to-wet corrected THC concentration,  $\chi_{\text{THC}[\text{THC-FID}]_{\text{cor}}}$ , as determined in paragraph (a) of this section, and the dry-to-wet corrected CH<sub>4</sub> concentration,  $\chi_{\text{THC}[\text{NMC-FID}]_{\text{cor}}}$ , optionally corrected for initial THC contamination as determined in paragraph (a) of this section.

(i) Use the following equation for an NMC configured as described in § 1065.365(d):

$$\chi_{\text{NMHC}} = \frac{x_{\text{THC}[\text{THC-FID}]_{\text{cor}}} \cdot RFPF_{\text{CH}_4[\text{NMC-FID}]} - x_{\text{THC}[\text{NMC-FID}]_{\text{cor}}} \cdot RF_{\text{CH}_4[\text{THC-FID}]}}{RFPF_{\text{CH}_4[\text{NMC-FID}]} - RFPF_{\text{C}_2\text{H}_6[\text{NMC-FID}]} \cdot RF_{\text{CH}_4[\text{THC-FID}]}}$$

Eq. 1065.660-2

Where:

$\chi_{\text{NMHC}}$  = concentration of NMHC.

$\chi_{\text{THC}[\text{THC-FID}]_{\text{cor}}}$  = concentration of THC, initial THC contamination and dry-to-wet corrected, as measured by the THC FID during sampling while bypassing the NMC.

$\chi_{\text{THC}[\text{NMC-FID}]_{\text{cor}}}$  = concentration of THC, initial THC contamination (optional) and dry-to-wet corrected, as measured by the NMC FID during sampling through the NMC.

$RF_{\text{CH}_4[\text{THC-FID}]}$  = response factor of THC FID to CH<sub>4</sub>, according to § 1065.360(d).

$RFPF_{\text{C}_2\text{H}_6[\text{NMC-FID}]}$  = NMC combined C<sub>2</sub>H<sub>6</sub> response factor and penetration fraction, according to § 1065.365(d).

$RFPF_{\text{CH}_4[\text{NMC-FID}]}$  = NMC combined CH<sub>4</sub> response factor and penetration fraction, according to § 1065.365(d).

*Example:*

$\chi_{\text{THC}[\text{THC-FID}]_{\text{cor}}} = 150.3 \mu\text{mol/mol}$

$\chi_{\text{THC}[\text{NMC-FID}]_{\text{cor}}} = 20.5 \mu\text{mol/mol}$

$RFPF_{\text{C}_2\text{H}_6[\text{NMC-FID}]} = 0.019$

$RFPF_{\text{CH}_4[\text{NMC-FID}]} = 1.000$

$RF_{\text{CH}_4[\text{THC-FID}]} = 1.05$

$$\chi_{\text{NMHC}} = \frac{150.3 - 20.5 \cdot 1.05}{1 - 0.019 \cdot 1.05}$$

$\chi_{\text{NMHC}} = 131.4 \mu\text{mol/mol}$

(ii) Use the following equation for penetration fractions determined using an NMC configuration as outlined in § 1065.365(e):

$$\chi_{\text{NMHC}} = \frac{x_{\text{THC}[\text{THC-FID}]_{\text{cor}}} \cdot PF_{\text{CH}_4[\text{NMC-FID}]} - x_{\text{THC}[\text{NMC-FID}]_{\text{cor}}}}{PF_{\text{CH}_4[\text{NMC-FID}]} - PF_{\text{C}_2\text{H}_6[\text{NMC-FID}]}}$$

Eq. 1065.660-3

Where:

$\chi_{\text{NMHC}}$  = concentration of NMHC.

$\chi_{\text{THC}[\text{THC-FID}]_{\text{cor}}}$  = concentration of THC, initial THC contamination and dry-to-wet corrected, as measured by the THC FID during sampling while bypassing the NMC.

$PF_{\text{CH}_4[\text{NMC-FID}]}$  = NMC CH<sub>4</sub> penetration fraction, according to § 1065.365(e).

$\chi_{\text{THC}[\text{NMC-FID}]_{\text{cor}}}$  = concentration of THC, initial THC contamination (optional) and dry-to-wet corrected, as measured by the THC FID during sampling through the NMC.

$PF_{\text{C}_2\text{H}_6[\text{NMC-FID}]}$  = NMC C<sub>2</sub>H<sub>6</sub> penetration fraction, according to § 1065.365(e).

*Example:*

$\chi_{\text{THC}[\text{THC-FID}]_{\text{cor}}} = 150.3 \mu\text{mol/mol}$

$PF_{\text{CH}_4[\text{NMC-FID}]} = 0.990$

$\chi_{\text{THC}[\text{NMC-FID}]_{\text{cor}}} = 20.5 \mu\text{mol/mol}$

$PF_{\text{C}_2\text{H}_6[\text{NMC-FID}]} = 0.020$

$$\chi_{\text{NMHC}} = \frac{150.3 \cdot 0.990 - 20.5}{0.990 - 0.020}$$

$\chi_{\text{NMHC}} = 132.3 \mu\text{mol/mol}$

(iii) Use the following equation for an NMC configured as described in § 1065.365(f):

$$\chi_{\text{NMHC}} = \frac{x_{\text{THC}[\text{THC-FID}]_{\text{cor}}} \cdot PF_{\text{CH}_4[\text{NMC-FID}]} - x_{\text{THC}[\text{NMC-FID}]_{\text{cor}}} \cdot RF_{\text{CH}_4[\text{THC-FID}]}}{PF_{\text{CH}_4[\text{NMC-FID}]} - RFPF_{\text{C}_2\text{H}_6[\text{NMC-FID}]} \cdot RF_{\text{CH}_4[\text{THC-FID}]}}$$

Eq. 1065.660-4

Where:

$\chi_{\text{NMHC}}$  = concentration of NMHC.

$\chi_{\text{THC}[\text{THC-FID}]_{\text{cor}}}$  = concentration of THC, initial THC contamination and dry-to-wet corrected, as measured by the THC

FID during sampling while bypassing the NMC.

$PF_{\text{CH}_4[\text{NMC-FID}]}$  = NMC CH<sub>4</sub> penetration fraction, according to § 1065.365(f).



$\chi_{\text{THC}[\text{NMC-FID}]_{\text{cor}}}$  = concentration of THC, initial THC contamination (optional) and dry-to-wet corrected, as measured by the THC FID during sampling through the NMC.

$RF_{\text{C}_2\text{H}_6[\text{NMC-FID}]}$  = NMC combined  $\text{C}_2\text{H}_6$  response factor and penetration fraction, according to § 1065.365(f).

$RF_{\text{CH}_4[\text{THC-FID}]}$  = response factor of THC FID to  $\text{CH}_4$ , according to § 1065.360(d).

Example:

$\chi_{\text{THC}[\text{THC-FID}]_{\text{cor}}} = 150.3 \mu\text{mol/mol}$   
 $PF_{\text{CH}_4[\text{NMC-FID}]} = 0.990$   
 $\chi_{\text{THC}[\text{NMC-FID}]_{\text{cor}}} = 20.5 \mu\text{mol/mol}$   
 $RF_{\text{C}_2\text{H}_6[\text{NMC-FID}]} = 0.019$   
 $RF_{\text{CH}_4[\text{THC-FID}]} = 0.980$

$$\chi_{\text{NMHC}} = \frac{150.3 \cdot 0.990 - 20.5 \cdot 0.980}{0.990 - 0.019 \cdot 0.980}$$

$$\chi_{\text{NMHC}} = 132.5 \mu\text{mol/mol}$$

(3) For a GC-FID or FTIR, calculate  $\chi_{\text{NMHC}}$  using the THC analyzer's  $\text{CH}_4$  response factor,  $RF_{\text{CH}_4[\text{THC-FID}]}$ , from § 1065.360, and the initial THC contamination and dry-to-wet corrected THC concentration,  $\chi_{\text{THC}[\text{THC-FID}]_{\text{cor}}}$ , as determined in paragraph (a) of this section as follows:

$$\chi_{\text{NMHC}} = \chi_{\text{THC}[\text{THC-FID}]_{\text{cor}}} - RF_{\text{CH}_4[\text{THC-FID}]} \cdot \chi_{\text{CH}_4}$$

Eq. 1065.660-5

Where:

$\chi_{\text{NMHC}}$  = concentration of NMHC.

$\chi_{\text{THC}[\text{THC-FID}]_{\text{cor}}}$  = concentration of THC, initial THC contamination and dry-to-wet corrected, as measured by the THC FID.

$RF_{\text{CH}_4[\text{THC-FID}]}$  = response factor of THC-FID to  $\text{CH}_4$ .

$\chi_{\text{CH}_4}$  = concentration of  $\text{CH}_4$ , dry-to-wet corrected, as measured by the GC-FID or FTIR.

Example:

$\chi_{\text{THC}[\text{THC-FID}]_{\text{cor}}} = 145.6 \mu\text{mol/mol}$   
 $RF_{\text{CH}_4[\text{THC-FID}]} = 0.970$   
 $\chi_{\text{CH}_4} = 18.9 \mu\text{mol/mol}$   
 $\chi_{\text{NMHC}} = 145.6 - 0.970 \cdot 18.9$   
 $\chi_{\text{NMHC}} = 127.3 \mu\text{mol/mol}$

(4) For an FTIR, calculate  $\chi_{\text{NMHC}}$  by summing the hydrocarbon species listed in § 1065.266(c) as follows:

$$\chi_{\text{NMHC}} = \sum_{i=1}^N (\chi_{\text{HC}_i} - \chi_{\text{HC}_i\text{-init}})$$

Eq. 1065.660-6

Where:

$\chi_{\text{NMHC}}$  = concentration of NMHC.

$\chi_{\text{HC}_i}$  = the  $\text{C}_1$ -equivalent concentration of hydrocarbon species  $i$  as measured by the FTIR, not corrected for initial contamination.

$\chi_{\text{HC}_i\text{-init}}$  = the  $\text{C}_1$ -equivalent concentration of the initial system contamination (optional) of hydrocarbon species  $i$ , dry-to-wet corrected, as measured by the FTIR.

Example:

$\chi_{\text{C}_2\text{H}_6} = 4.9 \mu\text{mol/mol}$   
 $\chi_{\text{C}_2\text{H}_4} = 0.9 \mu\text{mol/mol}$   
 $\chi_{\text{C}_2\text{H}_2} = 0.8 \mu\text{mol/mol}$   
 $\chi_{\text{C}_3\text{H}_8} = 0.4 \mu\text{mol/mol}$   
 $\chi_{\text{C}_3\text{H}_6} = 0.5 \mu\text{mol/mol}$   
 $\chi_{\text{C}_4\text{H}_{10}} = 0.3 \mu\text{mol/mol}$

$\chi_{\text{CH}_2\text{O}} = 0.8 \mu\text{mol/mol}$   
 $\chi_{\text{C}_2\text{H}_4\text{O}} = 0.3 \mu\text{mol/mol}$   
 $\chi_{\text{CH}_2\text{O}_2} = 0.1 \mu\text{mol/mol}$   
 $\chi_{\text{CH}_4\text{O}} = 0.1 \mu\text{mol/mol}$   
 $\chi_{\text{NMHC}} = 4.9 + 0.9 + 0.8 + 0.4 + 0.5 + 0.3 + 0.8 + 0.3 + 0.1 + 0.1$

$\chi_{\text{NMHC}} = 9.1 \mu\text{mol/mol}$

(c) *NMNEHC determination.* Use one of the following methods to determine NMNEHC concentration,  $\chi_{\text{NMNEHC}}$ :

(1) Calculate  $\chi_{\text{NMNEHC}}$  based on the test fuel's ethane content as follows:

(i) If the content of your test fuel contains less than 0.010 mol/mol of ethane, you may omit the calculation of NMNEHC concentration and calculate the mass of NMNEHC as described in § 1065.650(c)(6)(i).

(ii) If the content of your fuel test contains at least 0.010 mol/mol of  $\text{C}_2\text{H}_6$ , you may omit the calculation of NMNEHC concentration and calculate the mass of NMNEHC as described in § 1065.650(c)(6)(ii).

(2) For a GC-FID, NMC FID, or FTIR, calculate  $\chi_{\text{NMNEHC}}$  using the THC analyzer's  $\text{CH}_4$  response factor,  $RF_{\text{CH}_4[\text{THC-FID}]}$ , and  $\text{C}_2\text{H}_6$  response factor,  $RF_{\text{C}_2\text{H}_6[\text{THC-FID}]}$ , from § 1065.360, the initial contamination and dry-to-wet corrected THC concentration,  $\chi_{\text{THC}[\text{THC-FID}]_{\text{cor}}}$ , as determined in paragraph (a) of this section, the dry-to-wet corrected  $\text{CH}_4$  concentration,  $\chi_{\text{CH}_4}$ , as determined in paragraph (d) of this section, and the dry-to-wet corrected  $\text{C}_2\text{H}_6$  concentration,  $\chi_{\text{C}_2\text{H}_6}$ , as determined in paragraph (e) of this section as follows:

$$\chi_{\text{NMNEHC}} = \chi_{\text{THC}[\text{THC-FID}]_{\text{cor}}} - \frac{RF_{\text{CH}_4[\text{THC-FID}]} \cdot \chi_{\text{CH}_4}}{RF_{\text{C}_2\text{H}_6[\text{THC-FID}]} \cdot \chi_{\text{C}_2\text{H}_6}}$$

Eq. 1065.660-7

Where:

$\chi_{\text{NMNEHC}}$  = concentration of NMNEHC.

$\chi_{\text{THC}[\text{THC-FID}]_{\text{cor}}}$  = concentration of THC, initial THC contamination and dry-to-wet corrected, as measured by the THC FID.

$RF_{\text{CH}_4[\text{THC-FID}]}$  = response factor of THC-FID to  $\text{CH}_4$ .

$\chi_{\text{CH}_4}$  = concentration of  $\text{CH}_4$ , dry-to-wet corrected, as measured by the GC-FID, NMC FID, or FTIR.

$RF_{\text{C}_2\text{H}_6[\text{THC-FID}]}$  = response factor of THC-FID to  $\text{C}_2\text{H}_6$ .

$\chi_{\text{C}_2\text{H}_6}$  = the  $\text{C}_1$ -equivalent concentration of  $\text{C}_2\text{H}_6$ , dry-to-wet corrected, as measured by the GC-FID or FTIR.

Example:

$\chi_{\text{THC}[\text{THC-FID}]_{\text{cor}}} = 145.6 \mu\text{mol/mol}$   
 $RF_{\text{CH}_4[\text{THC-FID}]} = 0.970$   
 $\chi_{\text{CH}_4} = 18.9 \mu\text{mol/mol}$   
 $RF_{\text{C}_2\text{H}_6[\text{THC-FID}]} = 1.02$   
 $\chi_{\text{C}_2\text{H}_6} = 10.6 \mu\text{mol/mol}$   
 $\chi_{\text{NMNEHC}} = 145.6 - 0.970 \cdot 18.9 - 1.02 \cdot 10.6$

$\chi_{\text{NMNEHC}} = 116.5 \mu\text{mol/mol}$

(3) For an FTIR, calculate  $\chi_{\text{NMNEHC}}$  by summing the hydrocarbon species listed in § 1065.266(c) as follows:

$$\chi_{\text{NMNEHC}} = \sum_{i=1}^N (\chi_{\text{HC}_i} - \chi_{\text{HC}_i\text{-init}})$$

Eq. 1065.660-8

Where:

$\chi_{\text{NMNEHC}}$  = concentration of NMNEHC.

$\chi_{\text{HC}_i}$  = the  $\text{C}_1$ -equivalent concentration of hydrocarbon species  $i$  as measured by the FTIR, not corrected for initial contamination.

$\chi_{\text{HC}_i\text{-init}}$  = the  $\text{C}_1$ -equivalent concentration of the initial system contamination (optional) of hydrocarbon species  $i$ , dry-to-wet corrected, as measured by the FTIR.

Example:

$\chi_{\text{C}_2\text{H}_4} = 0.9 \mu\text{mol/mol}$   
 $\chi_{\text{C}_2\text{H}_2} = 0.8 \mu\text{mol/mol}$   
 $\chi_{\text{C}_3\text{H}_8} = 0.4 \mu\text{mol/mol}$   
 $\chi_{\text{C}_3\text{H}_6} = 0.5 \mu\text{mol/mol}$   
 $\chi_{\text{C}_4\text{H}_{10}} = 0.3 \mu\text{mol/mol}$   
 $\chi_{\text{CH}_2\text{O}} = 0.8 \mu\text{mol/mol}$   
 $\chi_{\text{C}_2\text{H}_4\text{O}} = 0.3 \mu\text{mol/mol}$   
 $\chi_{\text{CH}_2\text{O}_2} = 0.1 \mu\text{mol/mol}$   
 $\chi_{\text{CH}_4\text{O}} = 0.1 \mu\text{mol/mol}$   
 $\chi_{\text{NMNEHC}} = 0.9 + 0.8 + 0.4 + 0.5 + 0.3 + 0.8 + 0.3 + 0.1 + 0.1$   
 $\chi_{\text{NMNEHC}} = 4.2 \mu\text{mol/mol}$

(d) *CH<sub>4</sub> determination.* Use one of the following methods to determine methane ( $\text{CH}_4$ ) concentration,  $\chi_{\text{CH}_4}$ :

(1) For an NMC, calculate  $\chi_{\text{CH}_4}$  using the NMC's penetration fractions, response factors, and/or combined penetration fractions and response factors as described in § 1065.365, the THC FID's  $\text{CH}_4$  response factor,  $RF_{\text{CH}_4[\text{THC-FID}]}$ , from § 1065.360, the

initial THC contamination and dry-to-wet corrected THC concentration,  $\chi_{\text{THC}[\text{THC-FID}]_{\text{cor}}}$ , as determined in paragraph (a) of this section, and the dry-to-wet corrected  $\text{CH}_4$  concentration,

$\chi_{\text{THC}[\text{NMC-FID}]_{\text{cor}}}$ , optionally corrected for initial THC contamination as determined in paragraph (a) of this section.

(i) Use the following equation for an NMC configured as described in § 1065.365(d):

$$x_{\text{CH}_4} = \frac{x_{\text{THC}[\text{NMC-FID}]_{\text{cor}}} - x_{\text{THC}[\text{THC-FID}]_{\text{cor}}} \cdot RFPF_{\text{C}_2\text{H}_6[\text{NMC-FID}]}}{RFPF_{\text{CH}_4[\text{NMC-FID}]} - RFPF_{\text{C}_2\text{H}_6[\text{NMC-FID}]} \cdot RF_{\text{CH}_4[\text{THC-FID}]}}$$

Eq. 1065.660–9

Where:

$x_{\text{CH}_4}$  = concentration of  $\text{CH}_4$ .

$\chi_{\text{THC}[\text{NMC-FID}]_{\text{cor}}}$  = concentration of THC, initial THC contamination (optional) and dry-to-wet corrected, as measured by the NMC FID during sampling through the NMC.

$\chi_{\text{THC}[\text{THC-FID}]_{\text{cor}}}$  = concentration of THC, initial THC contamination and dry-to-wet corrected, as measured by the THC FID during sampling while bypassing the NMC.

$RFPF_{\text{C}_2\text{H}_6[\text{NMC-FID}]}$  = NMC combined  $\text{C}_2\text{H}_6$  response factor and penetration fraction, according to § 1065.365(d).

$RF_{\text{CH}_4[\text{THC-FID}]}$  = response factor of THC FID to  $\text{CH}_4$ , according to § 1065.360(d).

$RFPF_{\text{CH}_4[\text{NMC-FID}]}$  = NMC combined  $\text{CH}_4$  response factor and penetration fraction, according to § 1065.365(d).

Example:

$\chi_{\text{THC}[\text{NMC-FID}]_{\text{cor}}} = 10.4 \text{ } \mu\text{mol/mol}$   
 $\chi_{\text{THC}[\text{THC-FID}]_{\text{cor}}} = 150.3 \text{ } \mu\text{mol/mol}$   
 $RFPF_{\text{C}_2\text{H}_6[\text{NMC-FID}]} = 0.019$   
 $RFPF_{\text{CH}_4[\text{NMC-FID}]} = 1.000$   
 $RF_{\text{CH}_4[\text{THC-FID}]} = 1.05$

$$x_{\text{CH}_4} = \frac{10.4 - 150.3 \cdot 0.019}{1 - 0.019 \cdot 1.05}$$

$$x_{\text{CH}_4} = 7.69 \text{ } \mu\text{mol/mol}$$

(ii) Use the following equation for an NMC configured as described in § 1065.365(e):

$$x_{\text{CH}_4} = \frac{x_{\text{THC}[\text{NMC-FID}]_{\text{cor}}} - x_{\text{THC}[\text{THC-FID}]_{\text{cor}}} \cdot PF_{\text{C}_2\text{H}_6[\text{NMC-FID}]}}{RF_{\text{CH}_4[\text{THC-FID}]} \cdot (PF_{\text{CH}_4[\text{NMC-FID}]} - PF_{\text{C}_2\text{H}_6[\text{NMC-FID}]})}$$

Eq. 1065.660–10

Where:

$x_{\text{CH}_4}$  = concentration of  $\text{CH}_4$ .

$\chi_{\text{THC}[\text{NMC-FID}]_{\text{cor}}}$  = concentration of THC, initial THC contamination (optional) and dry-to-wet corrected, as measured by the NMC FID during sampling through the NMC.

$\chi_{\text{THC}[\text{THC-FID}]_{\text{cor}}}$  = concentration of THC, initial THC contamination and dry-to-wet corrected, as measured by the THC

FID during sampling while bypassing the NMC.

$PF_{\text{C}_2\text{H}_6[\text{NMC-FID}]}$  = NMC  $\text{C}_2\text{H}_6$  penetration fraction, according to § 1065.365(e).

$RF_{\text{CH}_4[\text{THC-FID}]}$  = response factor of THC FID to  $\text{CH}_4$ , according to § 1065.360(d).

$PF_{\text{CH}_4[\text{NMC-FID}]}$  = NMC  $\text{CH}_4$  penetration fraction, according to § 1065.365(e).

Example:

$\chi_{\text{THC}[\text{NMC-FID}]_{\text{cor}}} = 10.4 \text{ } \mu\text{mol/mol}$   
 $\chi_{\text{THC}[\text{THC-FID}]_{\text{cor}}} = 150.3 \text{ } \mu\text{mol/mol}$

$PF_{\text{C}_2\text{H}_6[\text{NMC-FID}]} = 0.020$

$RF_{\text{CH}_4[\text{THC-FID}]} = 1.05$

$PF_{\text{CH}_4[\text{NMC-FID}]} = 0.990$

$$x_{\text{CH}_4} = \frac{10.4 - 150.3 \cdot 0.020}{1.05 \cdot (0.990 - 0.020)}$$

$$x_{\text{CH}_4} = 7.25 \text{ } \mu\text{mol/mol}$$

(iii) Use the following equation for an NMC configured as described in § 1065.365(f):

$$x_{\text{CH}_4} = \frac{x_{\text{THC}[\text{NMC-FID}]_{\text{cor}}} - x_{\text{THC}[\text{THC-FID}]_{\text{cor}}} \cdot RFPF_{\text{C}_2\text{H}_6[\text{NMC-FID}]}}{PF_{\text{CH}_4[\text{NMC-FID}]} - RFPF_{\text{C}_2\text{H}_6[\text{NMC-FID}]} \cdot RF_{\text{CH}_4[\text{THC-FID}]}}$$

Eq. 1065.660–11

Where:

$x_{\text{CH}_4}$  = concentration of  $\text{CH}_4$ .

$\chi_{\text{THC}[\text{NMC-FID}]_{\text{cor}}}$  = concentration of THC, initial THC contamination (optional) and dry-to-wet corrected, as measured by the NMC FID during sampling through the NMC.

$\chi_{\text{THC}[\text{THC-FID}]_{\text{cor}}}$  = concentration of THC, initial THC contamination and dry-to-wet corrected, as measured by the THC FID during sampling while bypassing the NMC.

$RFPF_{\text{C}_2\text{H}_6[\text{NMC-FID}]}$  = the combined  $\text{C}_2\text{H}_6$  response factor and penetration fraction of the NMC, according to § 1065.365(f).

$PF_{\text{CH}_4[\text{NMC-FID}]}$  = NMC  $\text{CH}_4$  penetration fraction, according to § 1065.365(f).

$RF_{\text{CH}_4[\text{THC-FID}]}$  = response factor of THC FID to  $\text{CH}_4$ , according to § 1065.360(d).

Example:

$\chi_{\text{THC}[\text{NMC-FID}]_{\text{cor}}} = 10.4 \text{ } \mu\text{mol/mol}$   
 $\chi_{\text{THC}[\text{THC-FID}]_{\text{cor}}} = 150.3 \text{ } \mu\text{mol/mol}$   
 $RFPF_{\text{C}_2\text{H}_6[\text{NMC-FID}]} = 0.019$   
 $PF_{\text{CH}_4[\text{NMC-FID}]} = 0.990$   
 $RF_{\text{CH}_4[\text{THC-FID}]} = 1.05$

$$x_{\text{CH}_4} = \frac{10.4 - 150.3 \cdot 0.019}{0.990 - 0.019 \cdot 1.05}$$

$$x_{\text{CH}_4} = 7.78 \text{ } \mu\text{mol/mol}$$

(2) For a GC-FID or FTIR,  $x_{\text{CH}_4}$  is the actual dry-to-wet corrected  $\text{CH}_4$  concentration as measured by the analyzer.

(e)  $\text{C}_2\text{H}_6$  determination. For a GC-FID or FTIR,  $\chi_{\text{C}_2\text{H}_6}$  is the  $\text{C}_1$ -equivalent, dry-to-wet corrected  $\text{C}_2\text{H}_6$  concentration as measured by the analyzer.

■ 163. Amend § 1065.670 by revising paragraphs (a) introductory text and (b) introductory text to read as follows:

**§ 1065.670 NO<sub>x</sub> intake-air humidity and temperature corrections.**

(a) For compression-ignition engines operating on carbon-containing fuels and lean-burn combustion engines operating on fuels other than carbon-containing fuels, correct for intake-air humidity using the following equation:

(b) For spark-ignition engines operating on carbon-containing fuels and stoichiometric combustion engines operating on fuels other than carbon-containing fuels, correct for intake-air humidity using the following equation:

■ 164. Amend § 1065.672 by revising paragraph (c) to read as follows:

**§ 1065.672 Drift correction.**

(c) *Drift validation.* After applying all the other corrections—except drift correction—to all the gas analyzer signals, calculate emissions according to § 1065.650. Then correct all gas analyzer signals for drift according to this section. Recalculate emissions using all of the drift-corrected gas analyzer signals. Validate and report the emission results before and after drift correction according to § 1065.550.

■ 165. Amend § 1065.695 by:  
 ■ a. Redesignating paragraphs (c)(9)(v) through (vii) as paragraphs (c)(9)(vi) through (viii); and

■ b. Adding new paragraph (c)(9)(v).  
 The addition reads as follows:

**§ 1065.695 Data requirements.**

(c) \* \* \*  
 (9) \* \* \*  
 (v) Chemical balance method—carbon-based or hydrogen-based chemical balance method.

■ 166. Amend § 1065.705 by revising paragraph (b) to read as follows:

**§ 1065.705 Residual and intermediate residual fuel.**

(b) The fuel must be free of used lubricating oil. Demonstrate this by showing that the fuel meets at least one of the following specifications.

(1) Zinc is at or below 15 mg per kg of fuel based on the procedures specified in IP—470, IP—501, or ISO 8217 (incorporated by reference, see § 1065.1010).

(2) Phosphorus is at or below 15 mg per kg of fuel based on the procedures specified in IP—500, IP—501, or ISO 8217 (incorporated by reference, see § 1065.1010).

(3) Calcium is at or below 30 mg per kg of fuel based on the procedures specified in IP—470, IP—501, or ISO

8217 (incorporated by reference, see § 1065.1010).

■ 167. Amend § 1065.715 in paragraph (a), table 1, by revising footnote “a” to read as follows:

**§ 1065.715 Natural gas.**

(a) \* \* \*

TABLE 1 OF § 1065.715—TEST FUEL SPECIFICATIONS FOR NATURAL GAS

Property	Value <sup>a</sup>
* * *	* * *
* * *	* * *

<sup>a</sup>Demonstrate compliance with fuel specifications based on the reference procedures in ASTM D1945 (incorporated by reference, see § 1065.1010), or on other measurement procedures using good engineering judgment.

■ 168. Amend § 1065.750 by revising paragraphs (a)(1)(ii), (a)(2)(i), (a)(3) introductory text, and (a)(3)(xiii) and adding paragraph (a)(6) to read as follows:

**§ 1065.750 Analytical gases.**

(a) \* \* \*

(1) \* \* \*

(ii) Contamination as specified in the following table:

TABLE 1 TO PARAGRAPH (a)(1)(ii) OF § 1065.750—GENERAL SPECIFICATIONS FOR PURIFIED GASES<sup>A</sup>

Constituent	Purified Air	Purified N <sub>2</sub>
THC (C <sub>1</sub> -equivalent) .....	≤ 0.05 μmol/mol .....	≤ 0.05 μmol/mol
CO .....	≤ 1 μmol/mol .....	≤ 1 μmol/mol
CO <sub>2</sub> .....	≤ 10 μmol/mol .....	≤ 10 μmol/mol
O <sub>2</sub> .....	0.205 to 0.215 mol/mol .....	≤ 2 μmol/mol
NO <sub>x</sub> .....	≤ 0.02 μmol/mol .....	≤ 0.02 μmol/mol
N <sub>2</sub> O <sup>b</sup> .....	≤ 0.02 μmol/mol .....	≤ 0.02 μmol/mol
H <sub>2</sub> <sup>c</sup> .....	≤ 1 μmol/mol .....	≤ 1 μmol/mol
NH <sub>3</sub> <sup>d</sup> .....	≤ 1 μmol/mol .....	≤ 1 μmol/mol
H <sub>2</sub> O <sup>e</sup> .....	≤ 5 μmol/mol .....	≤ 5 μmol/mol

<sup>a</sup> We do not require these levels of purity to be NIST-traceable.  
<sup>b</sup> The N<sub>2</sub>O limit applies only if the standard-setting part requires you to report N<sub>2</sub>O or certify to an N<sub>2</sub>O standard.  
<sup>c</sup> The H<sub>2</sub> limit only applies for testing with H<sub>2</sub> fuel.  
<sup>d</sup> The NH<sub>3</sub> limit only applies for testing with NH<sub>3</sub> fuel.  
<sup>e</sup> The H<sub>2</sub>O limit only applies for water measurement according to § 1065.257.

(2) \* \* \*  
 (i) *FID fuel.* Use FID fuel with a stated H<sub>2</sub> concentration of (0.39 to 0.41) mol/mol, balance He or N<sub>2</sub>, and a stated total hydrocarbon concentration of 0.05 μmol/mol or less. For GC-FIDs that measure methane (CH<sub>4</sub>) using a FID fuel that is balance N<sub>2</sub>, perform the CH<sub>4</sub> measurement as described in SAE J1151

(incorporated by reference, see § 1065.1010).  
 (3) Use the following gas mixtures, with gases traceable within ±1% of the NIST-accepted gas standard value or other gas standards we approve:  
 (xiii) CH<sub>4</sub>, CH<sub>2</sub>O<sub>2</sub>, C<sub>2</sub>H<sub>2</sub>, C<sub>2</sub>H<sub>4</sub>, C<sub>2</sub>H<sub>4</sub>O, C<sub>2</sub>H<sub>6</sub>, C<sub>3</sub>H<sub>8</sub>, C<sub>3</sub>H<sub>6</sub>, CH<sub>4</sub>O, and C<sub>4</sub>H<sub>10</sub>. You may omit individual gas constituents

from this gas mixture. If your gas mixture contains oxygenated hydrocarbons, your gas mixture must be in balance purified N<sub>2</sub>, otherwise you may use balance purified air.  
 (6) If you measure H<sub>2</sub>O using an FTIR analyzer, generate H<sub>2</sub>O calibration gases with a humidity generator using one of the options in this paragraph (a)(6). Use good engineering judgment to prevent

condensation in the transfer lines, fittings, or valves from the humidity generator to the FTIR analyzer. Design your system so the wall temperatures in the transfer lines, fittings, and valves from the point where the mole fraction of H<sub>2</sub>O in the humidified calibration gas,  $x_{\text{H}_2\text{Oref}}$ , is measured to the analyzer are at a temperature of (110 to 202) °C. Calibrate the humidity generator upon initial installation, within 370 days before verifying the H<sub>2</sub>O measurement of the FTIR, and after major maintenance. Use the uncertainties from the calibration of the humidity

generator's measurements and follow NIST Technical Note 1297 (incorporated by reference, see § 1065.1010) to verify that the amount of H<sub>2</sub>O in the calibration gas,  $x_{\text{H}_2\text{Oref}}$ , is determined within ±3% uncertainty,  $U_{x_{\text{H}_2\text{O}}}$ . If the humidity generator requires assembly before use, after assembly follow the instrument manufacturer's instructions to check for leaks. You may generate the H<sub>2</sub>O calibration gas using one of the following options:  
 (i) Bubble gas that meets the requirements of paragraph (a)(1) of this section through distilled H<sub>2</sub>O in a sealed

vessel. Adjust the amount of H<sub>2</sub>O in the calibration gas by changing the temperature of the H<sub>2</sub>O in the sealed vessel. Determine absolute pressure,  $p_{\text{abs}}$ , and dewpoint,  $T_{\text{dew}}$ , of the humidified gas leaving the sealed vessel. Calculate the amount of H<sub>2</sub>O in the calibration gas as described in § 1065.645(a) and (b). Calculate the uncertainty of the amount of H<sub>2</sub>O in the calibration gas,  $U_{x_{\text{H}_2\text{O}}}$ , using the following equations:

$$\frac{\partial x_{\text{H}_2\text{O}}}{\partial T_{\text{dew}}} = x_{\text{H}_2\text{O}} \cdot \left( \frac{6790.241 + 2.961487 \cdot 10^{4.76955 \cdot \left(1 - \frac{273.16}{T_{\text{dew}}}\right)}}{T_{\text{dew}}^2} - \frac{5.028}{T_{\text{dew}}} + 2.423229 \cdot 10^{-5} \cdot 10^{-8.2969 \cdot \left(\frac{T_{\text{dew}}}{273.16} - 1\right)} \right)$$

Eq. 1065.750-1

Eq. 1065.750-2

$$\frac{\partial x_{\text{H}_2\text{O}}}{\partial p_{\text{abs}}} = -1 \cdot \frac{x_{\text{H}_2\text{O}}}{p_{\text{abs}}}$$

$$U_{x_{\text{H}_2\text{O}}} = \sqrt{\left(\frac{\partial x_{\text{H}_2\text{O}}}{\partial p_{\text{abs}}} \cdot U_{p_{\text{abs}}}\right)^2 + \left(\frac{\partial x_{\text{H}_2\text{O}}}{\partial T_{\text{dew}}} \cdot U_{T_{\text{dew}}}\right)^2}$$

Eq. 1065.750-3

Where:

$T_{\text{dew}}$  = saturation temperature of water at measured conditions.

$U_{T_{\text{dew}}}$  = expanded uncertainty (k = 2) of the measured saturation temperature of water at measured conditions.

$p_{\text{abs}}$  = wet static absolute pressure at the location of the dewpoint measurement.

$U_{p_{\text{abs}}}$  = expanded uncertainty (k = 2) of the wet static absolute pressure at the location of the dewpoint measurement.

$\frac{\partial x_{\text{H}_2\text{O}}}{\partial T_{\text{dew}}}$  = partial derivative of  $x_{\text{H}_2\text{O}}$  with respect to  $T_{\text{dew}}$ .

$\frac{\partial x_{\text{H}_2\text{O}}}{\partial p_{\text{abs}}}$  = partial derivative of  $x_{\text{H}_2\text{O}}$  with respect to  $p_{\text{abs}}$ .

$x_{\text{H}_2\text{O}}$  = amount of water in the calibration gas.

$U_{x_{\text{H}_2\text{O}}}$  = expanded uncertainty (k = 2) of the amount of H<sub>2</sub>O in the calibration gas.

Example:

$T_{\text{dew}} = 39.5 \text{ °C} = 312.65 \text{ K}$

$U_{T_{\text{dew}}} = 0.390292 \text{ K}$

$p_{\text{abs}} = 99.980 \text{ kPa}$

$U_{p_{\text{abs}}} = 1.15340 \text{ kPa}$

Using Eq. 1065.645-1,

$x_{\text{H}_2\text{O}} = 0.0718436 \text{ mol/mol}$

$$\frac{\partial x_{H_2O}}{\partial T_{dew}} = 0.0718436 \cdot \left( \frac{6790.241 + 2.961487 \cdot 10^{4.76955 \cdot \left(1 - \frac{273.16}{312.65}\right)}}{312.65^2} - \frac{5.028}{312.65} + 2.423229 \cdot 10^{-5} \cdot 10^{-8.2969 \cdot \left(\frac{312.65}{273.16} - 1\right)} \right)$$

$$\frac{\partial x_{H_2O}}{\partial T_{dew}} = 0.00384409 \text{ (mol/mol)/K}$$

$$\frac{\partial x_{H_2O}}{\partial p_{abs}} = -1 \cdot \frac{0.0718436}{99.980}$$

$$\frac{\partial x_{H_2O}}{\partial p_{abs}} = -0.000718580 \text{ (mol/mol)/kPa}$$

$$U_{x_{H_2O}} = \sqrt{(-0.000718580 \cdot 1.15340)^2 + (0.00384409 \cdot 0.390292)^2}$$

$$U_{x_{H_2O}} = 0.00171402 \text{ mol/mol}$$

(ii) Use a device that introduces a measured flow of distilled H<sub>2</sub>O as vapor into a measured flow of gas that meets the requirements of paragraph (a)(1) of this section. Determine the molar flows of gas and H<sub>2</sub>O that are mixed to generate the calibration gas.

(A) Calculate the amount of H<sub>2</sub>O in the calibration gas as follows:

$$x_{H_2O} = \frac{\dot{n}_{H_2O}}{\dot{n}_{gas} + \dot{n}_{H_2O}}$$

Eq. 1065.750-4

(B) Calculate the uncertainty of the amount of H<sub>2</sub>O in the generated calibration gas,  $U_{x_{H_2O}}$ , using the following equations:

$$\frac{\partial x_{H_2O}}{\partial \dot{n}_{gas}} = -1 \cdot \frac{\dot{n}_{H_2O}}{(\dot{n}_{gas} + \dot{n}_{H_2O})^2}$$

Eq. 1065.750-5

$$\frac{\partial x_{H_2O}}{\partial \dot{n}_{H_2O}} = \frac{\dot{n}_{gas}}{(\dot{n}_{gas} + \dot{n}_{H_2O})^2}$$

Eq. 1065.750-6

$$U_{x_{H_2O}} = \sqrt{\left(\frac{\partial x_{H_2O}}{\partial \dot{n}_{gas}} \cdot U_{\dot{n}_{gas}}\right)^2 + \left(\frac{\partial x_{H_2O}}{\partial \dot{n}_{H_2O}} \cdot U_{\dot{n}_{H_2O}}\right)^2}$$

Eq. 1065.750-7

Where:

$\dot{n}_{gas}$  = molar flow of gas entering the humidity generator.

$U_{\dot{n}_{gas}}$  = expanded uncertainty (k=2) of the molar flow of gas entering the humidity generator.

$\dot{n}_{H_2O}$  = molar flow of H<sub>2</sub>O entering the humidity generator, mol/s.

$U_{\dot{n}_{H_2O}}$  = expanded uncertainty (k=2) of the molar flow of H<sub>2</sub>O entering the humidity generator.

$\frac{\partial x_{H_2O}}{\partial \dot{n}_{gas}}$  = partial derivative of  $x_{H_2O}$  with respect to  $\dot{n}_{gas}$ .

$\frac{\partial x_{H_2O}}{\partial \dot{n}_{H_2O}}$  = partial derivative of  $x_{H_2O}$  with respect to  $\dot{n}_{H_2O}$ .

$x_{H_2O}$  = amount of H<sub>2</sub>O in the calibration gas.  
 $U_{x_{H_2O}}$  = expanded uncertainty (k=2) of the amount of H<sub>2</sub>O in the generated calibration gas.

(C) The following example is a solution for using the equations in paragraph (a)(6)(ii)(B) of this section:  
 $\dot{n}_{H_2O} = 0.00138771 \text{ mol/s}$

$U_{\dot{n}_{gas}} = 0.000226137 \text{ mol/s}$   
 $\dot{n}_{gas} = 0.0148680 \text{ mol/s}$   
 $U_{\dot{n}_{H_2O}} = 0.0000207436 \text{ mol/s}$

$$x_{H_2O} = \frac{0.00138771}{0.0148680 + 0.00138771}$$

$$x_{H_2O} = 0.0853676 \text{ mol/mol}$$

$$\frac{\partial x_{H_2O}}{\partial \dot{n}_{gas}} = -1 \cdot \frac{0.00138771}{(0.0148680 + 0.00138771)^2}$$

$$\frac{\partial x_{H_2O}}{\partial \dot{n}_{gas}} = -5.25155 \text{ (mol/mol)/(mol/s)}$$

$\frac{\partial x_{H_2O}}{\partial \dot{n}_{gas}}$  = partial derivative of  $x_{H_2O}$  with respect to  $\dot{n}_{gas}$ .  
 $\frac{\partial x_{H_2O}}{\partial \dot{n}_{H_2O}}$  = partial derivative of  $x_{H_2O}$  with respect to  $\dot{n}_{H_2O}$ .

\* \* \* \* \*  
 ■ 169. Amend § 1065.805 by revising paragraph (f) to read as follows:

**§ 1065.805 Sampling system.**

(f) You may sample alcohols or carbonyls using “California Non-Methane Organic Gas Test Procedures” (incorporated by reference, see § 1065.1010). If you use this method, follow its calculations to determine the mass of the alcohol/carbonyl in the exhaust sample, but follow subpart G of this part for all other calculations (40 CFR part 1066, subpart G, for vehicle testing).

\* \* \* \* \*  
 ■ 170. Amend § 1065.935 by revising paragraph (g)(5)(ii) to read as follows:

**§ 1065.935 Emission test sequence for field testing.**

(g) \* \* \*  
 (5) \* \* \*

(ii) Invalidate any data for periods in which the CO and CO<sub>2</sub> gas analyzers do not meet the drift criterion in § 1065.550. For HC, invalidate data if the difference between the uncorrected and the corrected brake-specific HC emission values are not within ±10% of the uncorrected results or the applicable standard, whichever is greater. For data that do meet the drift criterion, correct the data for drift according to § 1065.672 and use the drift-corrected results in emissions calculations.

\* \* \* \* \*  
 ■ 171. Amend § 1065.1001 by:

- a. Adding a definition of “Carbon-containing fuel” in alphabetical order;
- b. Revising the definition for “HEPA filter”;
- c. Adding definitions of “Lean-burn engine” and “Neat” in alphabetical order; and
- b. Revising the definitions of “NIST-traceable” and “Rechargeable Energy Storage System (RESS)”.

The additions and revisions read as follows:

**§ 1065.1001 Definitions.**

*Carbon-containing fuel* means an engine fuel that is characterized by compounds containing carbon. For example, gasoline, diesel, alcohol, liquefied petroleum gas, and natural gas are carbon-containing fuels.

*HEPA filter* means high-efficiency particulate air filters that are rated to achieve a minimum initial particle-removal efficiency of 99.97% using ASTM F1471 (incorporated by reference, see § 1065.1010).

*Lean-burn engine* means an engine with a nominal air fuel ratio substantially leaner than stoichiometric. For example, diesel-fueled engines are typically lean-burn engines, and gasoline-fueled engines are lean-burn engines if they have an air-to-fuel mass ratio above 14.7:1.

*Neat* means fuel that is free from mixture or dilution with other fuels. For

example, hydrogen or natural gas fuel used without diesel pilot fuel are neat.

\* \* \* \* \*  
*NIST-traceable* means relating to a standard value that can be related to NIST-stated references through an unbroken chain of comparisons, all having stated uncertainties, as specified in NIST Technical Note 1297 (incorporated by reference, see § 1065.1010). Allowable uncertainty limits specified for NIST-traceability refer to the propagated uncertainty specified by NIST.

\* \* \* \* \*  
*Rechargeable Energy Storage System (RESS)* means engine or equipment components that store recovered energy for later use to propel the vehicle or accomplish a different primary function. Examples of RESS include the battery system or a hydraulic accumulator in a hybrid vehicle.

\* \* \* \* \*  
 ■ 172. Amend § 1065.1010 by revising paragraphs (a)(40) and (e)(2) to read as follows:

**§ 1065.1010 Incorporation by reference.**

(a) \* \* \*  
 (40) ASTM D6348–12 <sup>epsiv:1</sup>, Standard Test Method for Determination of Gaseous Compounds by Extractive Direct Interface Fourier Transform Infrared (FTIR) Spectroscopy, approved February 1, 2012 (“ASTM D6348”), IBR approved for §§ 1065.257(b), 1065.266(c), 1065.275(b), and 1065.277(b).

(e) \* \* \*  
 (2) NIST Technical Note 1297, 1994 Edition, Guidelines for Evaluating and Expressing the Uncertainty of NIST Measurement Results, IBR approved for §§ 1065.365(g), 1065.750(a), and 1065.1001.

\* \* \* \* \*  
 ■ 173. Revise § 1065.1137 to read as follows:

**§ 1065.1137 Determination of thermal reactivity coefficient.**

This section describes the method for determining the thermal reactivity coefficient(s) used for thermal heat load calculation in the accelerated aging protocol.

(a) The calculations for thermal degradation are based on the use of an Arrhenius rate law function to model cumulative thermal degradation due to heat exposure. Under this model, the thermal aging rate constant, *k*, is an exponential function of temperature which takes the form shown in the following equation:

$$k = A \cdot e^{-\frac{E_a}{R \cdot T}}$$

Eq. 1065.1137-1

Where:

*A* = frequency factor or pre-exponential factor.

*E<sub>a</sub>* = thermal reactivity coefficient.

*R* = molar gas constant.

*T* = catalyst temperature.

(b) The process of determining *E<sub>a</sub>* begins with determining what catalyst characteristic will be tracked as the basis for measuring thermal deactivation. This metric varies for each type of catalyst and may be determined from the experimental data using good engineering judgment. We recommend the following metrics; however, you may also use a different metric based on good engineering judgment:

(1) *Copper-based zeolite SCR*. Total ammonia (NH<sub>3</sub>) storage capacity is a key aging metric for copper-zeolite SCR catalysts, and they typically contain multiple types of storage sites. It is typical to model these catalysts using two different storage sites, one of which is more active for NO<sub>x</sub> reduction, as this has been shown to be an effective metric for tracking thermal aging. In this case, there are two recommended aging metrics:

(i) The ratio between the storage capacity of the two sites, with more active site being in the denominator.

(ii) Storage capacity of the more active site.

(2) *Iron-based zeolite SCR*. Total NH<sub>3</sub> storage capacity is a key aging metric for iron-zeolite SCR catalysts. Using a

single storage site is the recommended metric for tracking thermal aging.

(3) *Vanadium SCR*. Brunauer–Emmett–Teller (BET) theory for determination of surface area is a key aging metric for vanadium-based SCR catalysts. Total NH<sub>3</sub> storage capacity may also be used as a surrogate to probe the surface area. If you use NH<sub>3</sub> storage to probe surface area, using a single storage site is the recommended metric for tracking thermal aging. You may also use low temperature NO<sub>x</sub> conversion as a metric. If you choose this option, you may be limited in your choice of temperatures for the experiment described in paragraph (c)(1) of this section due to vanadium volatility. In that case, it is possible that you may need to run a longer experimental duration than the recommended 64 hours to reach reliably measurable changes in NO<sub>x</sub> conversion.

(4) *Zone-coated zeolite SCR*. This type of catalyst is zone coated with both copper- and iron-based zeolite. As noted in paragraphs (b)(1) and (2) of this section, total NH<sub>3</sub> storage capacity is a key aging metric, and each zone must be evaluated separately.

(5) *Diesel oxidation catalysts*. The key aging metric for tracking thermal aging for DOCs which are used to optimize exhaust characteristics for a downstream SCR system is the conversion rate of NO to NO<sub>2</sub>. Select a conversion rate temperature less than or equal to 200 °C using good engineering judgement. The key aging metric for DOCs, which are part of a system that does not contain an SCR catalyst for NO<sub>x</sub> reduction, is the HC reduction efficiency (as measured using ethylene). Select a conversion rate temperature less than or equal to 200 °C using good engineering judgement. This same guidance applies to an oxidation catalyst coated onto the surface of a DPF, if there is no other DOC in the system.

(c)(1) Use good engineering judgment to select at least three different temperatures to complete the degradation experiments. We recommend selecting these temperatures to accelerate thermal deactivation such that measurable changes in the aging metric can be observed at multiple time points over the course of no more than 64 hours. Avoid temperatures that are too high to prevent rapid catalyst failure by a mechanism that does not represent normal aging. An example of temperatures to run the degradation experiment at for a small-pore copper zeolite SCR catalyst is 600 °C, 650 °C, and 725 °C.

(2) For each aging temperature selected, perform testing to assess the aging metric at different times. These time intervals do not need to be evenly spaced and it is typical to complete these experiments using increasing time intervals (e.g., after 2, 4, 8, 16, and 32 hours). Use good engineering judgment to stop each temperature experiment after sufficient data has been generated to characterize the shape of the deactivation behavior at a given temperature.

(i) For SCR-based NH<sub>3</sub> storage capacity testing, perform a Temperature Programmed Desorption (TPD) following NH<sub>3</sub> saturation of the catalyst (i.e., ramping gas temperature from 200 to 550 °C) to quantify total NH<sub>3</sub> released during the TPD.

(ii) For DOC formulations, conduct an NO Reverse Light Off (RLO) to quantify oxidation conversion efficiency of NO to NO<sub>2</sub> (i.e., ramping gas temperature from 500 to 150 °C).

(d) Generate a fit of the deactivation data generated in paragraph (b) of this section at each temperature.

(1) *Copper-based zeolite SCR*. Process all NH<sub>3</sub> TPD data from each aging condition using an algorithm to fit the NH<sub>3</sub> desorption data.

(i) We recommend that you use the Temkin adsorption model to quantify the NH<sub>3</sub> TPD at each site to determine the desorption peaks of individual storage sites. The adsorption model is adapted from “Adsorption of Nitrogen and the Mechanism of Ammonia Decomposition Over Iron Catalysts” (Brunauer, S. *et al*, Journal of the American Chemical Society, 1942, 64 (4), 751–758) and “On Kinetic Modeling of Change in Active Sites upon Hydrothermal Aging of Cu–SSZ–13” (Daya, R. *et al*, Applied Catalysis B: Environmental, 2020, 263, 118368–118380). It is generalized using the following equation (assuming a two-site model):

$$\frac{d\theta}{dt} = k\theta$$

Eq. 1065.1137-2

Where:

*k* =  $e - E_a(1 - \alpha\theta)^{RT}$

*E<sub>a</sub>* = thermal reactivity coefficient of ammonia desorption.

*α* = Temkin constant.

*θ* = fraction of adsorption sites currently occupied (initial *θ* is assumed to be 1).

*R* = molar gas constant.

*T* = aging temperature.

(A) Use Eq. 1065.1137-2 to express the NH<sub>3</sub> storage site desorption peaks as follows:

$$\text{Site}_1 = N_1 \cdot A_1 \cdot e^{\left[ \frac{E_{a,T1}(1-\alpha_1\theta_1)}{R \cdot T} \right]} \cdot \theta_1$$

$$\text{Site}_2 = N_2 \cdot A_2 \cdot e^{\left[ \frac{E_{a,T2}(1-\alpha_2\theta_2)}{R \cdot T} \right]} \cdot \theta_2$$

Eq. 1065.1137-3

Where:

- $N_1$  = moles of  $\text{NH}_3$  desorbed from Site 1.
- $A_1$  = pre-exponential factor associated with Site 1.
- $E_{a,T1}$  = thermal reactivity coefficient of ammonia desorption for Site 1.
- $N_2$  = moles of  $\text{NH}_3$  desorbed from Site 2.
- $A_2$  = pre-exponential factor associated with Site 2.
- $E_{a,T2}$  = thermal reactivity coefficient of ammonia desorption for Site 2.

(B) Optimize  $E_{a,T1}$ ,  $\alpha_1$ ,  $A_1$ ,  $E_{a,T2}$ ,  $\alpha_2$ , and  $A_2$  to fit each  $\text{NH}_3$  TPD peak to give the best fit. The moles of  $\text{NH}_3$  ( $N_1$  and  $N_2$ ) may vary for each individual TPD data set.

(ii) Use one of the following modeling approaches to derive the thermal reactivity coefficient,  $E_{a,D}$ . We recommend that you use both models to fit the data and check that the resulting  $E_{a,D}$  values for the two methods are within 3% of each other.

(A) *General Power Law Expression (GPLe)*. Generate a fit of the deactivation data from paragraph (d)(1)(i) of this section for each aging temperature using the following expression:

$$-\frac{d\Omega}{dt} = k_D \cdot (\Omega - \Omega_{eq})^m$$

Eq. 1065.1137-4

Where:

$k_D$  = the thermal aging rate constant.

$$k_D = A \cdot e^{-\frac{E_{a,D}}{R \cdot T}}$$

Eq. 1065.1137-5

$A$  = pre-exponential factor.

$E_{a,D}$  = thermal reactivity coefficient.

$R$  = molar gas constant.

$T$  = aging temperature.

$\Omega = N_2/N_1$  or  $N_2$  (normalizing  $\Omega$  to the degreened  $\Omega$  value for each new catalyst component prior to aging is recommended (*i.e.*,  $\Omega = 1$  at  $t = 0$  for each aging temperature)).

$\Omega_{eq}$  = aging metric at equilibrium (set = 0 unless there is a known activity minimum).

$m$  = model order (assumed to be 2 for copper-based zeolite SCR).

(1) Solve Eq. 1065.1137-4 for  $\Omega$  to yield the following expression:

$$\Omega = \left[ A \cdot e^{-\frac{E_{a,D}}{R \cdot T}} \cdot t + \Omega_0 \right]^{-1}$$

Eq. 1065.1137-6

Where:

- $\Omega_0 = 1$  (assumes that  $N_2/N_1$  or  $N_2$  values were normalized to the degreened value for each aging temperature).
- $A$  = pre-exponential factor.
- $E_{a,D}$  = thermal reactivity coefficient.
- $R$  = molar gas constant.
- $T$  = aging temperature.
- $t$  = aging time.

(2) Use a global fitting approach to solve for  $E_{a,D}$  and  $A_D$  by applying a generalized reduced gradient (GRG) nonlinear minimization algorithm, or equivalent. For the global fitting approach, optimize the model by minimizing the Global Sum of Square Errors ( $SSE_{Global}$ ) between the experimental  $\Omega$  and model  $\Omega$  while only allowing  $E_{a,D}$  and  $A_D$  to vary. Global SSE is defined as the summed total SSE for all aging temperatures evaluated.

$$SSE_{Global} = \sum_{i=0}^n SSE_{Ti}$$

Eq. 1065.1137-7

Where:

- $n$  = total number of aging temperatures.
- $i$  = an indexing variable that represents one aging temperature.
- $SSE_T$  = sum of square errors (SSE) for a single aging temperature,  $T$ , (see Eq. 1065.1137-8).

$$SSE_T = \sum_{i=0}^n (\Omega_{Exp_i} - \Omega_{model_i})^2$$

Eq. 1065.1137-8

Where:

- $n$  = total number of aging intervals for a single aging temperature.
- $i$  = an indexing variable that represents one aging interval for a single aging temperature.
- $\Omega_{Exp}$  = experimentally derived aging metric for aging temperature,  $T$ .
- $\Omega_{model}$  = aging metric calculated from Eq. 1065.1137-6 for aging temperature,  $T$ .

(B) *Arrhenius approach*. In the Arrhenius approach, the deactivation rate constant,  $k_D$ , of the aging metric,  $\Omega$ , is calculated at each aging temperature.

(1) Generate a fit of the deactivation data in paragraph (d)(1)(i) of this section at each aging temperature using the following linear expression:

$$\frac{1}{\Omega} = k_D \cdot t + 1$$

Eq. 1065.1137-9

Where:

- $\Omega = N_2/N_1$  or  $N_2$  ( $\Omega$  is to be normalized to the degreened  $\Omega$  value for each new catalyst component prior to aging, *i.e.*,  $\Omega = 1$  at  $t = 0$  for each aging temperature).

$$k_D = A \cdot e^{-\frac{E_{a,D}}{R \cdot T}}$$

(Eq. 1065.1137-5)

$A$  = pre-exponential factor.

$E_{a,D}$  = thermal reactivity coefficient.

$R$  = molar gas constant.

$T$  = aging temperature.

(2) Generate a plot of  $1/\Omega$  versus  $t$  for each aging temperature evaluated in paragraph (c)(1) in this section. The slope of each line is equal to the thermal aging rate,  $k_D$ , at a given aging temperature. Using the data pairs of aging temperature and thermal aging rate constant,  $k_D$ , determine the thermal reactivity coefficient,  $E_a$ , by performing a regression analysis of the natural log of  $k_D$  versus the inverse of temperature,  $T$ , in Kelvin. Determine  $E_{a,D}$  from the slope of the resulting regression line,  $m_{deactivation}$ , using the following equation:

$$E_{a,D} = -m_{deactivation} \cdot R$$

Eq. 1065.1137-10

Where:

- $m_{deactivation}$  = the slope of the regression line of  $\ln(k_D)$  versus  $1/T$ .
- $R$  = molar gas constant.

(2) *Iron-based zeolite or vanadium SCR*. Process all  $\text{NH}_3$  TPD data from each aging condition using a GPLe to fit the  $\text{NH}_3$  desorption data (or BTE surface area data for vanadium SCR). Note that this expression is different from the one used in paragraph (d)(1)(ii)(A) of this section because the model order  $m$  is allowed to vary. This general expression takes the following form:

$$-\frac{d\Omega}{dt} = k_D \cdot (\Omega - \Omega_{eq})^m$$

Eq. 1065.1137-11

Where:

- $\Omega$  = total  $\text{NH}_3$  (or BET surface area) normalized to the degreened value for each new catalyst component prior to aging (*i.e.*,  $\Omega = 1$  at  $t = 0$  for each aging temperature).



$$k_D = A \cdot e^{-\frac{E_{a,D}}{R \cdot T}}$$

Eq. 1065.1137-5)

A = pre-exponential factor.  
 $E_{a,D}$  = thermal reactivity coefficient.

R = molar gas constant.  
 T = aging temperature.  
 t = time.  
 $\Omega_{eq}$  = aging metric at equilibrium (set to 0 unless there is a known activity minimum).

m = model order.

(i) Solve Eq. 1065.1137-10 for  $\Omega$  to yield the following expression:

$$\Omega = \left[ (m - 1) \cdot A \cdot e^{-\frac{E_{a,D}}{R \cdot T}} \cdot t + (\Omega_0)^{1-m} \right]^{1/1-m}$$

Eq. 1065.1137-12

Where:

$\Omega_0 = 1$  (assumes total NH<sub>3</sub> storage, or BET surface area, was normalized to the degreened value for each aging temperature).

A = pre-exponential factor.  
 $E_{a,D}$  = thermal reactivity coefficient.  
 R = molar gas constant.  
 T = aging temperature.  
 t = aging time.  
 m = model order (to be varied from 1 to 8 using whole numbers).

(ii) Global fitting is to be used to solve for  $E_{a,D}$  and  $A_D$  by applying a GRG nonlinear minimization algorithm, as described in paragraph (d)(1)(ii)(A) of this section. Minimize the  $SSE_{Global}$  for each model order, m, while only allowing  $E_{a,D}$  and  $A_D$  to vary. The optimal solution is determined by selecting the model order, m, that yields the lowest global fit SSE. If you have a range of model order solutions where the  $SSE_{Global}$  does not vary substantially, use good engineering judgement to choose the lowest m for this range.

(3) *Zone-coated zeolite SCR*. Derive the thermal reactivity coefficient,  $E_{a,D}$ , for each zone of the SCR, based on the guidance provided in paragraphs (d)(1) and (2) of this section. The zone that yields the lowest  $E_{a,D}$  shall be used for calculating the target cumulative thermal load, as outlined in § 1065.1139.

(4) *Diesel oxidation catalyst*. (i) The catalyst monolith is modeled as a plug flow reactor with first order reaction rate:

$$-v \frac{dX}{dV} = k_D \cdot (1 - X)$$

Eq. 1065.1137-13

Where:

v = velocity.  
 X = conversion (NO to NO<sub>2</sub>) in %/100.  
 V = volume of reactor.

$$k_D = A_D \cdot e^{-\frac{E_{a,D}}{R \cdot T}}$$

Eq. 1065.1137-14

$A_D$  = pre-exponential factor.  
 $E_{a,D}$  = thermal reactivity coefficient.  
 R = molar gas constant.  
 T = aging temperature.

(ii) For a diesel oxidation catalyst, the preexponential term  $A_D$  is proportional to the number of active sites and is the desired aging metric. Solving Eq. 1065.1137-13 for  $k_D$ , substituting it for  $k_D$  in Eq. 1065.1137-5, and then solving for  $A_D$  yields Eq. 1065.1137-15:

$$A_D = \frac{-SV \cdot \ln(1 - X \%)}{e^{-E_{a,D}/RT}}$$

Eq. 1065.1137-15

Where:

SV = space velocity used during RLO testing.  
 X = conversion (NO to NO<sub>2</sub>).  
 $E_{a,D}$  = thermal reactivity coefficient.  
 T = temperature where X was measured.  
 R = molar gas constant.

(iii) Process all NO to NO<sub>2</sub> oxidation RLO data for each aging condition by determining the average oxidation

conversion efficiency, X, at the temperature determined in paragraph (b)(5) of this section. We recommend maintaining the target oxidation conversion temperature to  $\pm 5$  °C. For each aging condition (aging temperature, T and aging time, t), calculate the aging metric,  $\Omega$ , by normalizing  $A_D$  to the degreened  $A_D$  value for each new catalyst component prior to aging (i.e.,  $\Omega = 1$  at t = 0 for each aging temperature).

(A) Use the GPLE to fit the NO to NO<sub>2</sub> conversion data, X, at each aging temperature. The GPLE takes the following form:

$$-\frac{d\Omega}{dt} = k_D \cdot (\Omega - \Omega_{eq})^m$$

Eq. 1065.1137-16

Where:

$\Omega$  = aging metric for diesel oxidation catalysts.

$$k_D = A_D \cdot e^{-\frac{E_{a,D}}{R \cdot T}}$$

(Eq. 1065.1137-14)

R = molar gas constant.  
 T = aging temperature.  
 t = aging time.  
 $\Omega_{eq}$  = aging metric at equilibrium (set to 0 unless there is a known activity minimum).  
 m = model order.

(B) Solve Eq. 1065.1137-12 for to yield the following expression:

$$\Omega = \left[ (m - 1) \cdot A \cdot e^{-\frac{E_{a,D}}{R \cdot T}} \cdot t + (\Omega_{eq})^{1-m} \right]^{1/1-m}$$

Eq. 1065.1137-17

Where:

$\Omega_{eq} = 1$  (assumes the oxidation efficiency, X, was normalized to the degreened value for each aging temperature).

A = pre-exponential factor.  
 $E_{a,D}$  = thermal reactivity coefficient.  
 R = molar gas constant.  
 T = aging temperature.  
 t = aging time.

m = model order (to be varied from 1 to 8 using whole numbers)

(iv) Use global fitting to solve for  $E_{a,D}$  and A by applying a GRG nonlinear minimization algorithm, as described in paragraph (d)(1)(ii)(A) of this section. Minimize the  $SSE_{Global}$  for each model order, m, while only allowing  $E_{a,D}$  and A to vary. The optimal solution is determined by selecting the model

order, m, that yields the lowest global fit SSE. If you have a range of model order solutions where the  $SSE_{Global}$  does not vary substantially, use good engineering judgement to choose the lowest m for this range.

■ 174. Amend § 1065.1139 by adding paragraphs (e)(6)(v) and (f)(3) and revising paragraphs (g)(1) introductory text and (h) to read as follows:

**§ 1065.1139 Aging cycle generation.**

\* \* \* \* \*

- (e) \* \* \*
- (6) \* \* \*

(v) If you are not able to achieve the target  $D_{i,field}$  using the steps in paragraphs (e)(6)(i) through (iv) of this section without exceeding catalyst temperature limits, use good engineering judgement to reduce the acceleration factor from 10 to a lower number. If you reduce the acceleration factor you must re-calculate the number of hours determine in paragraph (a) of this section and re-run the process in this paragraph (e). Note that if you reduce the acceleration factor you must use the same lower acceleration factor in the chemical exposure calculations in paragraph (h) of this section, instead of 10.

(f) \* \* \*

(3) If you are not able to achieve the target  $D_{i,field}$  using the steps in paragraphs (f)(1) and (2) of this section without exceeding catalyst temperature limits, use good engineering judgement to reduce the acceleration factor from 10 to a lower number. If you reduce the acceleration factor you must re-calculate the number of hours determine in paragraph (a) of this section and re-run the process in this paragraph (f). Note

that if you reduce the acceleration factor you must use the same lower acceleration factor in the chemical exposure calculations in paragraph (h) of this section, instead of 10.

(g) \* \* \*

(1) *Cycle assembly with infrequent regenerations.* For systems that use infrequent regenerations, the number of cycle repeats is equal to the number of regeneration events that happen over full useful life. The total cycle duration of the aging cycle is calculated as the total aging duration in hours divided by the number of infrequent regeneration events. In the case of systems with multiple types of infrequent regenerations, use the regeneration with the lowest frequency to calculate the cycle duration.

\* \* \* \* \*

(h) *Chemical exposure targets.*

Determine targets for accelerated oil and fuel sulfur exposure as follows:

(1) *Oil exposure targets.* The target oil exposure rate during accelerated aging is 10 times the field average oil consumption rate determined in § 1065.1133(a)(2). You must achieve this target exposure rate on a cycle average basis during aging. Use good engineering judgment to determine the oil exposure rates for individual

operating modes that will achieve this cycle average target. For engine-based aging stands you will likely have different oil consumption rates for different modes depending on the speed and load conditions you set. For burner-based aging stands, you may find that you have to limit oil exposure rates at low exhaust flow or low temperature modes to ensure good atomization of injected oil. On a cycle average basis, the portion of oil exposure from the volatile introduction pathway (*i.e.*, oil doped in the burner or engine fuel) must be between (10 to 30) % of the total. The remainder of oil exposure must be introduced through bulk pathway.

(2) *Fuel sulfur exposure targets.* The target sulfur exposure rate for fuel-related sulfur is determined by utilizing the field mean fuel rate data for the engine determined in § 1065.1133(a)(3). Calculate the total sulfur exposure mass using this mean fuel rate, the total number of non-accelerated hours to reach full useful life, and a fuel sulfur level of 10 ppmw.

(i) For an engine-based aging stand, if you perform accelerated sulfur exposure by additizing engine fuel to a higher sulfur level, determine the accelerated aging target additized fuel sulfur mass fraction,  $w_S$ , as follows:

$$w_{S,target} = \frac{\bar{m}_{fuel,field}}{\bar{m}_{fuel,cycle}} \cdot m_{Sfuel,ref} \cdot S_{acc,rate}$$

Eq. 1065.1139-9

Where:

- $\bar{m}_{fuel,field}$  = field mean fuel flow rate.
- $\bar{m}_{fuel,cycle}$  = accelerated aging cycle mean fuel low rate.
- $m_{Sfuel,ref}$  = reference mass of sulfur per mass of fuel = 0.00001 kg/kg.
- $S_{acc,rate}$  = sulfur acceleration rate = 10.

Example:

- $\bar{m}_{fuel,field}$  = 54.3 kg/hr
- $\bar{m}_{fuel,cycle}$  = 34.1 kg/hr
- $m_{Sfuel,ref}$  = 0.00001 kg/kg.
- $S_{acc,rate}$  = 10

$$w_{S,target} = \frac{54.3}{34.1} \cdot 0.00001 \cdot 10$$

$$w_{S,target} = 0.000159$$

(ii) If you use gaseous SO<sub>2</sub> to perform accelerated sulfur exposure, such as on a burner-based stand, calculate the target SO<sub>2</sub> concentration to be introduced,  $x_{SO2,target}$ , as follows:

$$x_{SO2,target} = \frac{\bar{m}_{fuel,field}}{\bar{m}_{exhaust,cycle}} \cdot \left( \frac{x_{Sfuel,ref} \cdot S_{acc,rate} \cdot M_{exh}}{M_S} \right)$$

Eq. 1065.1139-10

Where:

- $\bar{m}_{fuel,field}$  = field mean fuel flow rate.
- $\bar{m}_{exhaust,cycle}$  = mean exhaust flow rate during the burner aging cycle.

- $x_{Sfuel,ref}$  = reference mol fraction of sulfur in fuel = 10 μmol/mol.
- $S_{acc,rate}$  = sulfur acceleration rate = 10.
- $M_{exh}$  = molar mass of exhaust = molar mass of air.
- $M_S$  = molar mass of sulfur.

Example:

- $\bar{m}_{fuel,field}$  = 54.3 kg/hr
- $\bar{m}_{exhaust,cycle}$  = 1000.8 kg/hr
- $x_{Sfuel,ref}$  = 10 μmol/mol
- $S_{acc,rate}$  = 10
- $M_{exh}$  = 28.96559 g/mol
- $M_S$  = 32.065 g/mol

$$x_{SO_2, target} = \frac{54.3}{1000.8} \cdot \left( \frac{10 \cdot 10 \cdot 28.96559}{32.065} \right)$$

$$x_{SO_2, target} = 4.90 \mu\text{mol/mol}$$

(iii) You may choose to turn off gaseous sulfur injection during infrequent regeneration modes, but if you do you must increase the target SO<sub>2</sub> concentration by the ratio of total aging time to total normal (non-regeneration) aging time.

■ 175. Amend § 1065.1141 by revising paragraphs (b) and (f) to read as follows:

**§ 1065.1141 Facility requirements for engine-based aging stands.**

\* \* \* \* \*

(b) Use good engineering judgment to modify the engine to increase oil consumption rates to levels required for accelerated aging. These increased oil consumption levels must be sufficient to reach the bulk pathway exposure targets determined in § 1065.1139(h). A combination of engine modifications and careful operating mode selection will be used to reach the final bulk pathway oil exposure target on a cycle average. You must modify the engine in a fashion that will increase oil consumption in a manner such that the oil consumption is still generally representative of oil passing the piston rings into the cylinder. Use good engineering judgment to break in the modified engine to stabilize oil consumption rates. We recommend the following methods of modification (in order of preference):

(1) Install the second compression ring inverted (upside down) on one or more of the cylinders of the bench aging engine. This is most effective on rings that feature a sloped design to promote oil control when normally installed.

(2) If the approach in paragraph (b)(1) of this section is insufficient to reach the targets, modify the oil control rings in one or more cylinders to reduce the spring tension on the oil control ring. It should be noted that this is likely to be

an iterative process until the correct modification has been determined.

(3) If the approach in paragraph (b)(2) of this section is insufficient to reach the targets, modify the oil control rings in one or more cylinders to create small notches or gaps (usually no more than 2 per cylinder) in the top portion of the oil control rings that contact the cylinder liner (care must be taken to avoid compromising the structural integrity of the ring itself).

\* \* \* \* \*

(f) Use good engineering judgment to incorporate a means of monitoring oil consumption on a periodic basis. You may use a periodic drain and weigh approach to quantify oil consumption. We recommend that you incorporate a method of continuous oil consumption monitoring, but you must validate that method with periodic draining and weighing of the engine oil. You must validate that the aging stand reaches oil consumption targets prior to the start of aging. You must verify oil consumption during aging prior to each emission testing point, and at each oil change interval. Validate or verify oil consumption over a running period of at least 72 hours to obtain a valid measurement. If you do not include the constant volume oil system recommended in paragraph (c) of this section, you must account for all oil additions.

\* \* \* \* \*

■ 176. Amend § 1065.1145 by revising paragraphs (d) and (e)(2)(i) to read as follows:

**§ 1065.1145 Execution of accelerated aging, cycle tracking, and cycle validation criteria.**

\* \* \* \* \*

(d) *Accelerated aging.* Following zero-hour emission testing and any engine

dynamometer aging, perform accelerated aging using the cycle validated in either paragraph (a)(1) or (2) of this section. Repeat the cycle the number of times required to reach full useful life equivalent aging. Interrupt the aging cycle as needed to conduct any scheduled intermediate emission tests, clean the DPF of accumulated ash, and for any facility-related reasons. We recommended you interrupt aging at the end of a given aging cycle, following the completion of any scheduled infrequent regeneration event. If an aging cycle is paused for any reason, we recommended that you resume the aging cycle at the same point in the cycle where it stopped to ensure consistent thermal and chemical exposure of the aftertreatment system.

(e) \* \* \*

(2) \* \* \*

(i) *Changing engine oil.* For an engine-based platform, periodically change engine oil to maintain stable oil consumption rates and maintain the health of the aging engine. Interrupt aging as needed to perform oil changes. Perform a drain-and-weigh measurement. If you see a sudden change in oil consumption it may be necessary to stop aging and either change oil or correct an issue with the accelerated oil consumption. If the aging engine requires repairs to correct an oil consumption issue in the middle of aging, you must re-validate the oil consumption rate for 72 hours before you continue aging. The engine exhaust should be left bypassing the aftertreatment system until the repaired engine has been validated.

\* \* \* \* \*

[FR Doc. 2024-06809 Filed 4-19-24; 8:45 am]

BILLING CODE 6560-50-P